

13.5w Inground Lights Installation Instructions



Product Specifications

Model No.	HCP-251133	HCP-251134	HCP-251135
Material	316 Stainless Steel Cover + Aluminium Body		
Colour	Stainless Steel		
IP Rating	IP67		
Input Voltage	24v DC		
Cut Out - With Canister	171mm		
Cut Out - Without Canister	160mm		
Trafficable	1000kgs		
IK Rating	IK10		
Protection Class	3 (No Earth Required) ⚡		
Lamp Base	Built in LED		
Lamp Wattage	1x 13.5w		
Colour Temp	3000K	4000K	5000K
Lumens	824lm	916lm	841lm
CRI	80+		
Dimmable	No		
Warranty	5 Years Replacement*		

Dimensions

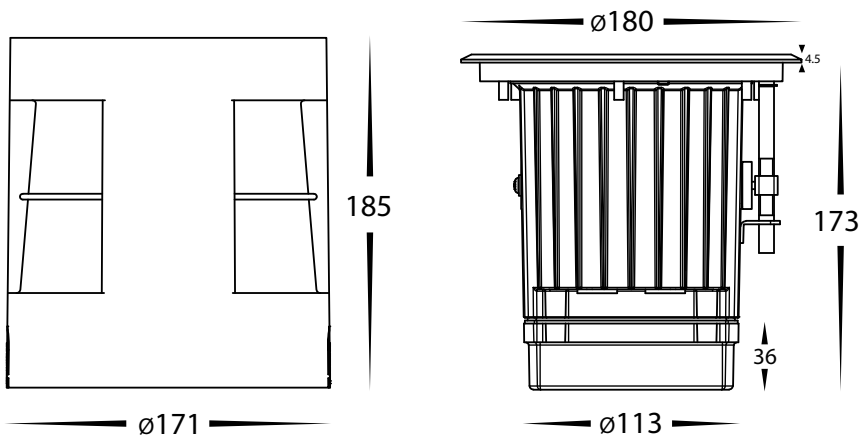

Adequate Drainage Diagram

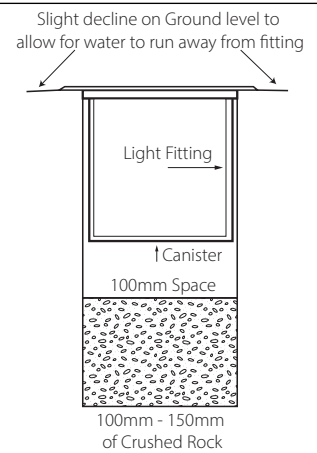

Important Safety Issues:

- This product must be installed by a qualified electrician according to AS/NZS 3000.
- Ensure all electrical mains are disconnected before any installation.
Modification of this product will void any warranty.
- Havit Commercial does not take responsibility for wrong installation, incorrect use, or use of installation material that does not belong to the system.
- All electrical connections must be watertight. If a watertight connection is not done, Warranty will be voided.
- When installing low voltage fittings, Voltage to fitting must be within +or- 5% of voltage required and cannot be installed more than 25m from LED Driver, if not within this allowance warranty will be voided.
- Aluminium and 304SS fittings must not be installed within 5km of any salt water environments.
- All o-rings and seals must be in place correctly to maintain warranty.
- These instructions may be updated at any time due to product improvements, Please visit website for most current installation instructions.

Steps for Installation for Single Colour Models:

1. Make sure that the electrical circuit is free of voltage (master switch off)
2. Make a hole where fitting is to be placed using dimensions provided in table, making sure adequate drainage is allowed.
3. If using canister, insert canister making sure that the top is level with ground or floor. Failure to do so will void warranty.
4. Using an appropriate 24v DC LED Driver - DO NOT CONNECT LIGHT FITTING DIRECTLY TO 240V
5. Connect the cable - If more than one fitting installed, wiring must be done in parallel. These fittings are POLARITY SENSITIVE, If connected incorrectly this will cause the failure of the fitting and will not be covered under warranty.
6. Strip back the cable on both fitting and cable run and twist the positive cables together. Then connect neutral cables together.
7. Solder all joins using solder and either a heat gun or butane gas torch.
8. Cover connections using an adhesive lined heat shrink or gel cap to make connection watertight. Failure to do this will void warranty.
9. Heat the heat shrink or crimp the gel cap making sure all connections are covered.
10. Make sure the seals are still in place and nuts on back of fitting are tight to avoid any water penetration.
11. Insert fitting into canister or hole. Apply silicon around edge of fitting to prevent any water from getting inside to electrical connections.
12. To adjust angle, Insert tool into 2 holes and rotate until you reach your desired angle.
13. All connections must be carried out carefully, inspect all contacts before switching back on the electric circuit.

Must be installed by a licensed electrician

Contact Details:

8/133 Beauchamp Road
Matraville NSW 2036
Australia
Tel: 02 9381 8383
Email: sales@havitcommercial.com.au
Web: www.havitcommercial.com.au

Warranty Terms & Conditions*



www.havitcommercial.com.au

