

AQUEA

V-LOCK LID

- ▶ SEAMLESS ACCESS TO SKIMMER BOXES
- ▶ LOCKABLE LID FOR ULTIMATE SAFETY
- ▶ MODELS FOR INLAYS 8 ~ 32mm THICK
- ▶ NO ELECTRICAL BONDING REQUIRED



**GOOD
DESIGN
AWARD®
WINNER**



**GOLD AWARD
PRODUCT OF
THE YEAR
VICTORIA 2023**



**GOLD AWARD
NEW PRODUCT
AWARD
VICTORIA 2023**



**HIGHLY
COMMENDED
NEW PRODUCT
AWARD
QUEENSLAND 2023**



**HIGHLY
COMMENDED
NEW PRODUCT
AWARD
NSW 2023**



**FINALIST
PRODUCT OF
THE YEAR
NATIONAL 2023**



**FINALIST
NEW PRODUCT
AWARD
NATIONAL 2023**

THE LOCKABLE CONCEALED LID

V-LOCK SETS THE NEW STANDARD FOR SAFE & CONCEALED SKIMMER BOX ACCESS

DESIGNED IN AUSTRALIA TO SUIT ALL POOL TYPES AND CONDITIONS

V-LOCK's unique locking system provides superior safety for pool owners and simplifies Australian standards compliance for pool builders.

The flush-fitting lid is easy to install and blends into the pool surrounds for a flawless finish every time. With a range of models to choose from, V-LOCK is the perfect solution for tile, stone and timber deck finishes.

Manufactured using advanced engineering polymers, V-LOCK delivers superior strength, rigidity and weatherability without the need for electrical bonding!

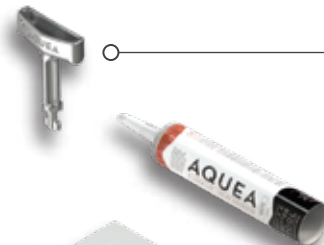

SAFE & SECURE

The V-LOCK Lid Key sets the new standard for safety and peace of mind.



SMART DESIGN

The V-LOCK Lid kit includes a spacer plate and adhesive for simple installation of all styles of tiling, paving and decking.

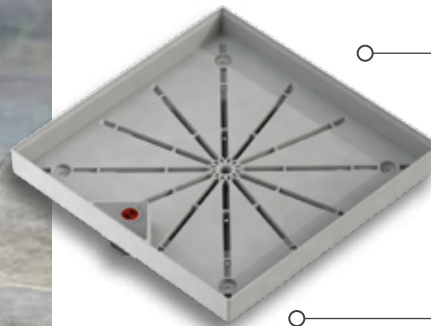

DURABLE

Reinforced polymer construction for superior rigidity, strength and weatherability.

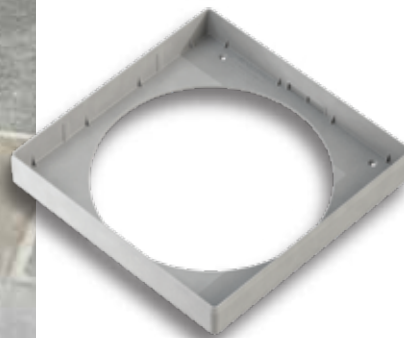

SEAMLESS FINISH

Available in a range of depths to suit tile, stone and timber inlays.

NO BONDING

V-LOCK's advanced polymer construction eliminates the need for electrical bonding.



Durable & ergonomic metal lid key



Twist & lift action for easy access to skimmer boxes



Suitable for use with tile, stone and timber decks



Polymer construction & superior lockable design

THE V-LOCK RANGE HAS THE PERFECT SOLUTION FOR YOUR POOL

THE V-LOCK RANGE



S-SERIES

S-SERIES lids are perfect for safe, concealed access in smaller applications.

Lockable with the V-LOCK Lid Key, S-SERIES lids comply with AS1926.3 for ultimate safety and peace of mind.

Possible applications include:

- ▶ Hydrostatic stand pipes (up to 165mm)
- ▶ Earthing hubs
- ▶ Plumbing inspection points
- ▶ Small skimmer boxes
- ▶ Small pool deck equipment



V-SERIES

V-SERIES lids are the best solution for concealed access to popular skimmer boxes & pool deck equipment.

Lockable with the robust V-LOCK Lid Key, V-SERIES lids are fully compliant with AS1926.3, providing unmatched safety and peace of mind.

Possible applications include:

- ▶ Standard Australian skimmers
- ▶ Auto levellers / fillers
- ▶ In-floor system leaf canisters
- ▶ Large diameter stand pipes
- ▶ Large plumbing inspection points



VS COMBO KITS

VS Combo Kits combine a V-SERIES and S-SERIES lid in one convenient package, complete with V-LOCK Lid Key and Adhesive.

VS Combo Kits are a simple and cost-effective solution when a multiple-lid installation is required, such as fibreglass pools.

Advantages of VS Combo Kits:

- ▶ Ideal for fibreglass pools
- ▶ Compatible with all pool types
- ▶ Convenient and cost effective

NEW POOLS AND RENOVATIONS

V-LOCK is suitable for new pools and renovations. With a simple installation process and ability to be retro-fitted into existing pool decks, V-LOCK provides a superior finish for all popular decking materials.

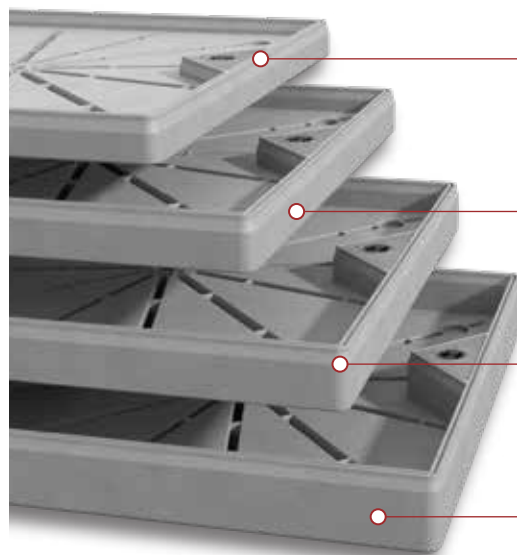

V10

For inlays 8~11mm thick

V15

For inlays 12~16mm thick

S20 V20 VS20

For inlays 15~22mm thick

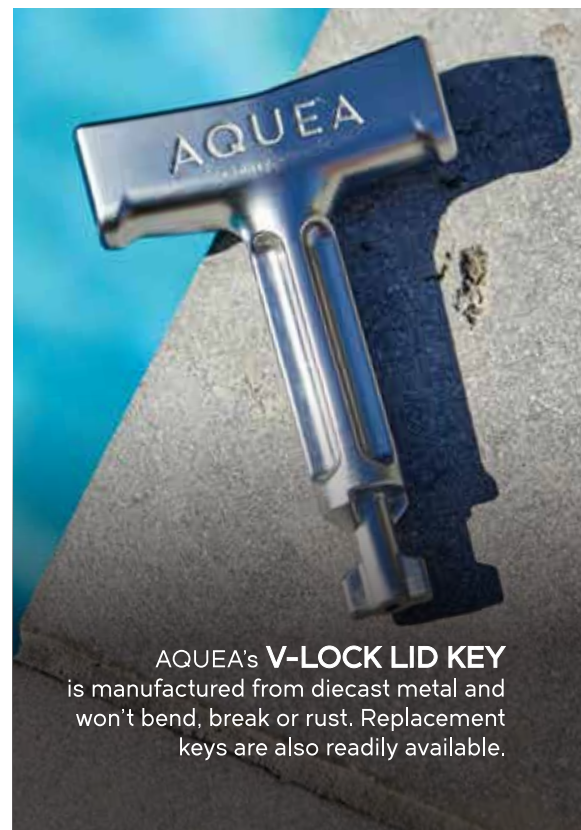

S30 V30 VS30

For inlays 25~32mm thick



AQUEA's **V-LOCK LID KEY** is manufactured from diecast metal and won't bend, break or rust. Replacement keys are also readily available.

SPECIFICATIONS

	S-SERIES	V-SERIES	VS COMBO KITS
COLOUR	 Cement Grey	 Cement Grey	 Cement Grey
POOL TYPE	Suits all pool types	Suits all pool types	Suits all pool types
WARRANTY	5 Years	5 Years	5 Years
KIT CONTENTS	<ul style="list-style-type: none"> > Outer Frame > Lid Assembly > Spacer Plate > Lid Key > Grouting Plugs 	<ul style="list-style-type: none"> > Outer Frame > Lid Assembly > Spacer Plate > Lid Key > Adhesive & Nozzle > Grouting Plugs 	<ul style="list-style-type: none"> > V-SERIES Outer Frame, Lid Assembly & Spacer Plate > S-SERIES Outer Frame, Lid Assembly & Spacer Plate > Lid Key > Adhesive & Nozzle > Grouting Plugs

INLAY THICKNESS	MODEL	PART #	MODEL	PART #	MODEL	PART #
8~11 mm	N/A	N/A	V10	475-201	N/A	N/A
12~16 mm	N/A	N/A	V15	475-203	N/A	N/A
15~22 mm	S20	475-219	V20	475-205	VS20	475-237
25~32 mm	S30	475-221	V30	475-207	VS30	475-238

KEY DIMENSIONS

All dimensions in mm | Tolerance +/- 1.0mm

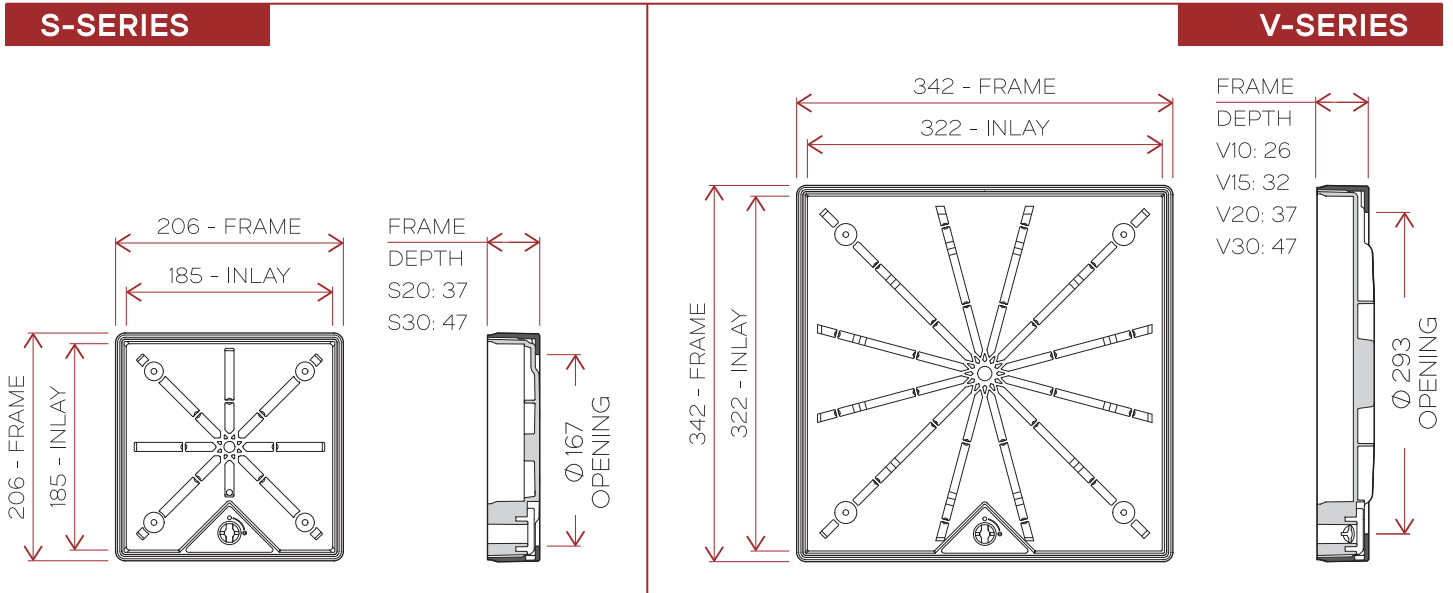

AQUEA® is a registered trademark of Vantage Products Pty. Ltd.
The contents of this document are the exclusive copyright of AQUEA® and may not be reproduced without written permission. © 2023
Whilst every care was taken in preparation of this document, AQUEA® accepts no responsibility for the accuracy of the information supplied.

Specifications subject to change without notice.

475-849-02

AQUEA

HELLO@AQUEA.COM.AU

WWW.AQUEA.COM.AU

0481 875 870



BUILD A BETTER POOL