



The MeatStick

TRUE Wireless Meat Thermometer

WHAT'S IN THE BOX:

1 x

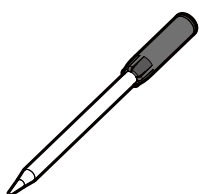

1 x



1 x



QUICK START

1. Download the app and create an account.



2. Place Stick on the charger, insert batteries, click the button to activate and charge stick for 4 hours before first use.



The light will turn off after 6 seconds.
(2 AAA batteries not included)

3. Set up Xtender (more info inside).



4. Press the button on the charger to activate the stick. Select the stick and choose your cook.



5. Remove the stick from the charger and insert completely up to the ceramic handle in the meat. The notch should be in the thickest part, away from fat and bones.



6. Get real-time data on your smartphone, we will let you know when it's ready.



**Thank you for choosing
The MeatStick!**

For more information please visit:

www.themeatstick.com

If you need help, contact support:





support@themeatstick.com

7. Enjoy your meat! Remember, the stick will be sizzling hot, be careful when removing it.



8. Allow the stick to cool down and clean to look like new.



 [thetruemeatstick](https://www.facebook.com/thetruemeatstick)  [truemeatstick](https://twitter.com/truemeatstick)
 [themeatstickig](https://www.instagram.com/themeatstickig)  [#mymeatstick](https://www.instagram.com/mymeatstick)

STICK & CHARGER

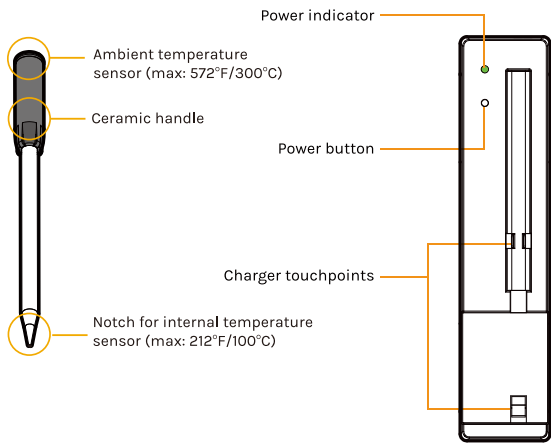

Stick lasts 24+ hours per charge.

XTENDER

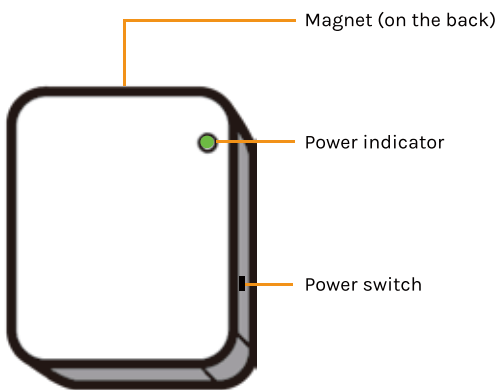

1. Insert 2 AA batteries.
2. Toggle the switch, place next to the stick and you're good to go.

CONNECTIVITY

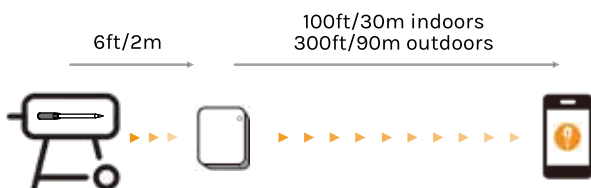

The Xtender is recommended to be within 6ft/2m from the stick.

CAUTION

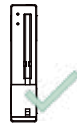

Charge the stick with the included battery-powered charger. Do not use the USB-powered version of the charger with the included stick.



If not being thrown into a heat source, the stick will turn off after 30 minutes of inactivity.



The internal and ambient sensors can measure and withstand up to 212°F/100°C and 572°F/300°C respectively. Temperatures above this may damage the stick.



Cooks over direct heat may cause fire flare-ups that can instantly exceed 900°F/500°C. Please be aware and remove the stick to avoid damaging.



Position the stick completely into the meat. This allows the stick to withstand high temperatures.



To ensure uninterrupted connectivity, we recommend the Xtender to be as close as possible to the stick (within 6ft/2m).



Do not use the stick in a microwave or pressure cooker.



The stick will be sizzling hot after each use. Do not touch with your bare hands.



The stick is waterproof, sous-vide, and dishwasher safe.

WANT TO MONITOR YOUR MEAT TEMPERATURES FROM ANYWHERE? GET THE WIFI BRIDGE!

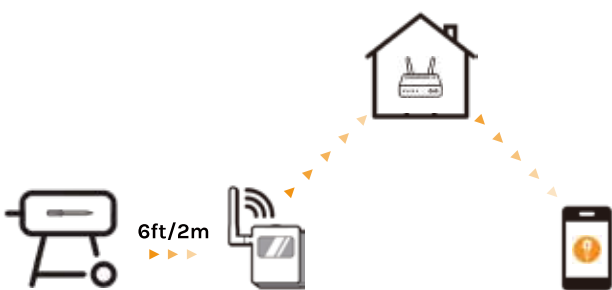

The MeatStick is modular, you create the set you want. Visit our website to add more sticks or add-ons to your collection!



All the MeatStick products are covered by a 1-year limited warranty. For more details you can visit us at: themeatstick.com/warranty.



Protect our planet by recycling packaging and electronic devices at the designated facilities.