



The MeatStick

TRUE Wireless Meat Thermometer

WHAT'S IN THE BOX:

2 x

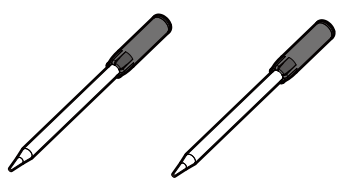

1 x



1 x

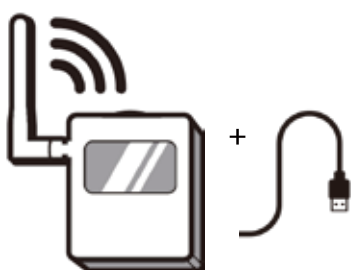

1 x

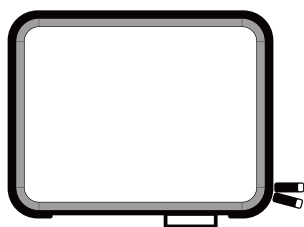

QUICK START

1. Download the app and create an account.



2. Place Stick on the charger, insert batteries, click the button to activate and charge stick for 4 hours before first use.



The light will turn off after 6 seconds.
(2 AAA batteries not included)

3. Set up WiFi Bridge (more info inside).



4. Press the button on the charger to activate the stick. Select the stick and choose your cook.



5. Remove the stick from the charger and insert completely up to the ceramic handle in the meat. The notch should be in the thickest part, away from fat and bones.



6. Get real-time data on your smartphone, we will let you know when it's ready.



**Thank you for choosing
The MeatStick!**

For more information please visit:

www.themeatstick.com

If you need help, contact support:

support@themeatstick.com

thetruemeatstick truemeatstick
 themeatstickig #mymeatstick

7. Enjoy your meat! Remember, the stick will be sizzling hot, be careful when removing it.



8. Allow the stick to cool down and clean to look like new.



STICK & CHARGER

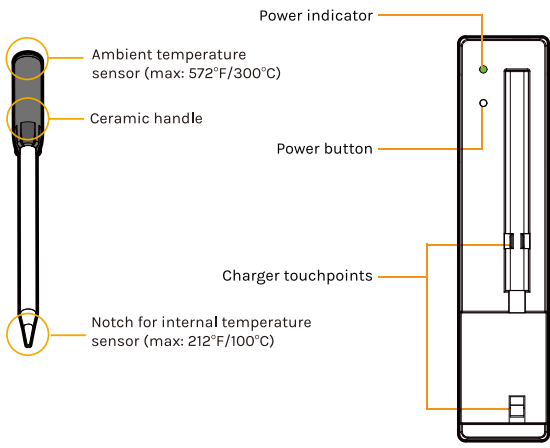

Stick lasts 24+ hours per charge.

WIFI BRIDGE SETUP

1. Plug in WiFi Bridge with included cable to a power source. For portability, use a portable USB battery pack.
2. Make sure your router is on, and follow the instructions in the app so the WiFi Bridge will connect to your home network.
3. Once set up, place the WiFi Bridge to be within 6ft/2m from the stick.

In case of no WiFi, you can use your WiFi Bridge in Xtender mode, just press the button when the LCD says "Check app" to set extended range up to 300ft/90m.

WIFI BRIDGE

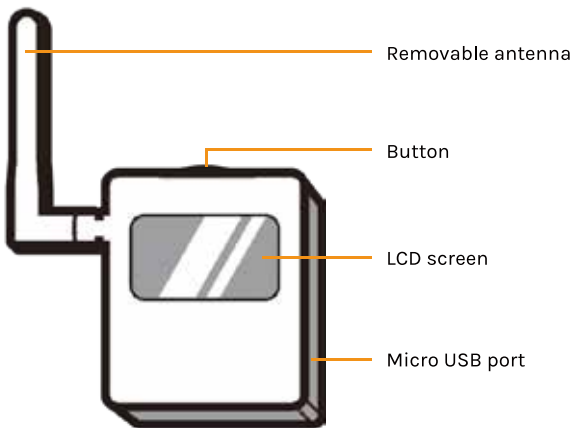

Do not use the stick in a microwave or pressure cooker.



The stick will be sizzling hot after each use. Do not touch with your bare hands.



The stick is waterproof, sous-vide, and dishwasher safe.

CONNECTIVITY

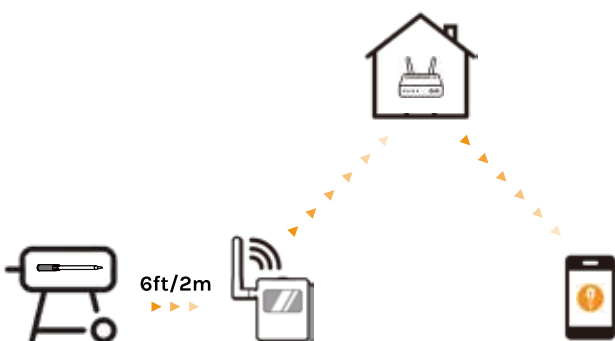

All the MeatStick products are covered by a 1-year limited warranty. Visit themeatstick.com/warranty for details.



The MeatStick is modular, you create the set you want. Visit our website to add more sticks or add-ons to your collection!



Protect our planet by recycling packaging and electronic devices at the designated facilities.

CAUTION

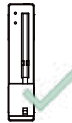

Charge the stick with the included battery-powered charger. Do not use the USB-powered version of the charger with the included stick.



If not being thrown into a heat source, the stick will turn off after 30 minutes of inactivity.



The internal and ambient sensors can measure and withstand up to 212°F/100°C and 572°F/300°C respectively. Temperatures above this may damage the stick.



Cooks over direct heat may cause fire flare-ups that can instantly exceed 900°F/500°C. Please be aware and remove the stick to avoid damaging.



Position the stick completely into the meat. This allows the stick to withstand the high temperatures.



To ensure uninterrupted connectivity, we recommend the WiFi Bridge to be as close as possible to the stick (6ft/2m).