

# CWM7.4 S2

1

1 x

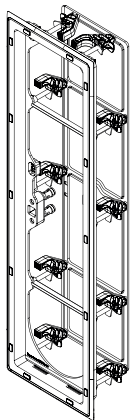

1 x

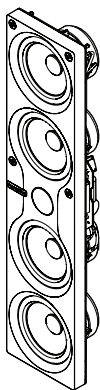

1 x



1 x

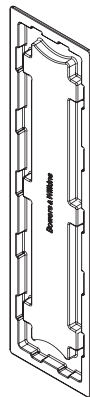

1 x

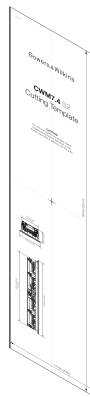

2

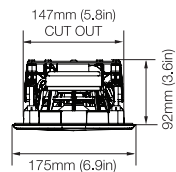
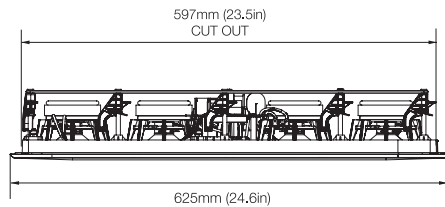
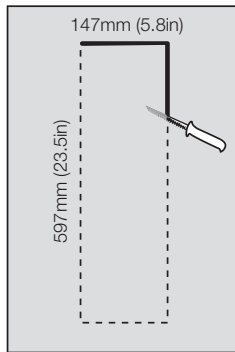
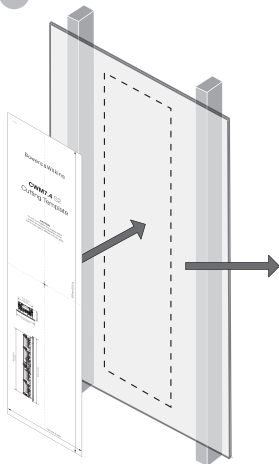

3

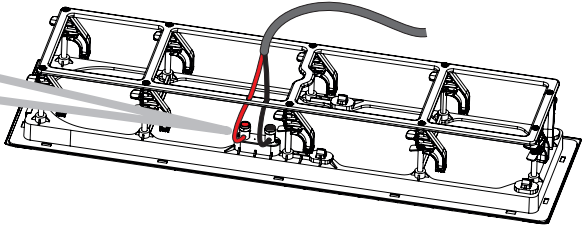
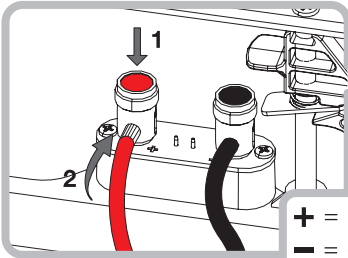

4

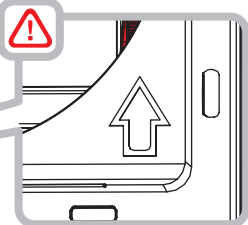
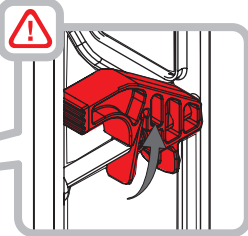
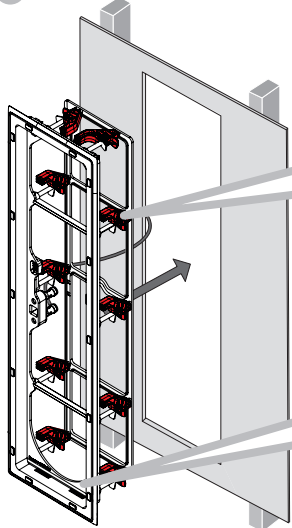

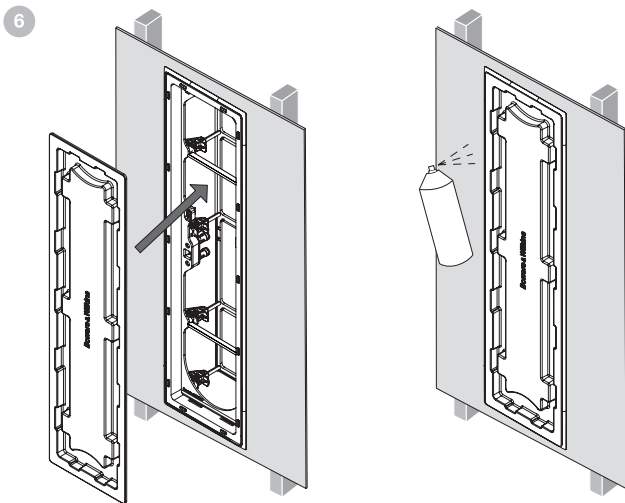
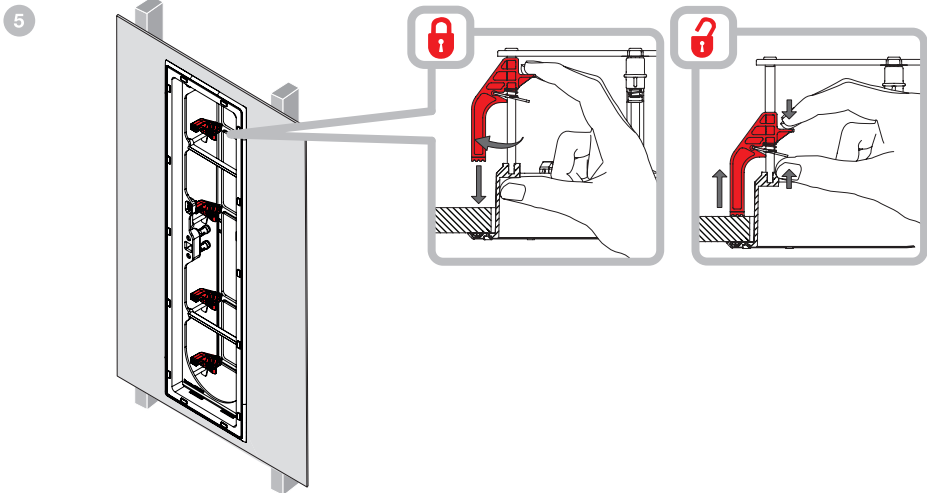

7

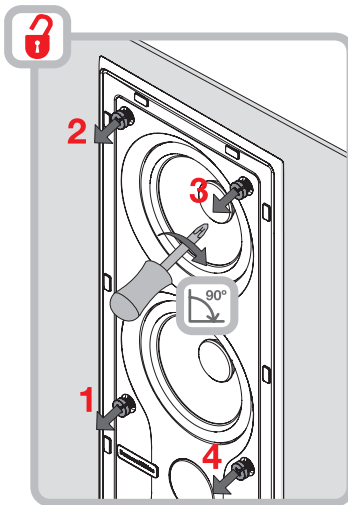
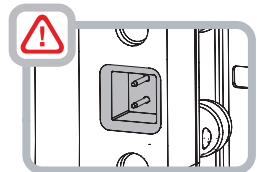
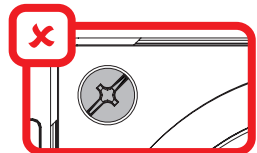
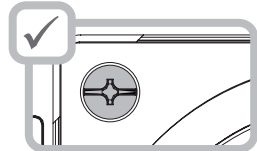
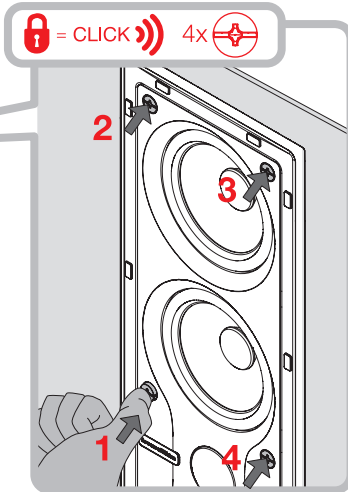
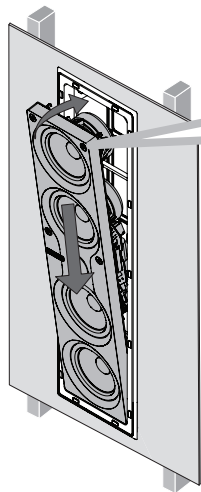

8

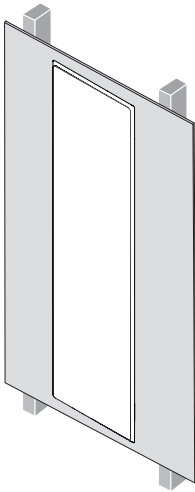
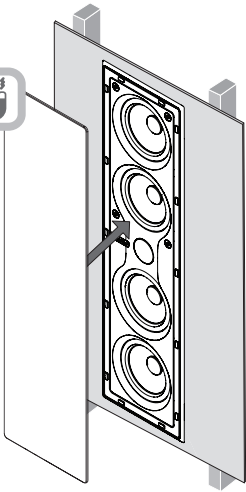



## ENGLISH

Installation must be carried out in accordance with national building and wiring regulations.

## FRAANÇAIS

L'installation doit être réalisée en conformité avec les réglementations nationales en matière de construction et de câblage.

## DEUTSCH

Bei der Installation müssen die nationalen Baubestimmungen und Verdrahtungsvorschriften eingehalten werden.

## ESPAÑOL

La instalación debe realizarse en concordancia con la normativa nacional en materia de construcción y cableado de edificios.

## PORTUGUÊS

A instalação tem de ser efectuada em conformidade com as regulamentações nacionais relativas a edifícios e respectivas instalações eléctricas.

## ITALIANO

L'installazione deve essere eseguita nel rispetto delle norme nazionali in materia di edilizia e di impianti elettrici.

## NEDERLANDS

De installatie moet in overeenstemming met de nationale bouw- en bedravingsvoorschriften worden uitgevoerd.

## ČESKY

Montáž musí být prováděna v souladu s místními stavebními a elektroinstalačními předpisy.

## SLOVENČINA

Instalácia musí byť vykonaná v súlade so zákonnými smernicami o stavbe a káblavani.

## MAGYAR

A szerelés a nemzeti építési és vezetékekre vonatkozó előírásoknak megfelelően kell elvégezni.

## POLSKI

Instalacje należy przeprowadzić zgodnie z krajowymi regulacjami budowlanymi i przepisami dotyczącymi instalacji elektrycznych.

## TÜRKÇE

Kurulum, ulusal inşaat ve elektrik şebekesi düzenlemelerine uygun olarak gerçekleştirilmelidir.

## ΕΛΛΗΝΙΚΑ

Η εγκατάσταση θα πρέπει να γίνεται με την εφαρμογή των εθνικών οικοδομικών κανονισμών, καθώς και των κανονισμών αναφορικά με τη συνδεσιμολογία και των καλωδίσεων.

## РУССКИЙ

Установка должна быть выполнена в соответствии с государственными строительными и пожарными нормами.

## 日本語

インストールは、国が定める建造物及び配線のレギュレーションに従って行わなければなりません。

## 简体中文

安装必须按照国家建筑和接线规定进行。

## 繁體中文

安裝必須按照國家建築和接線規定進行。

## 한국어

설치는 국가 건물 및 배선 규정에 따라 수행해야 합니다.

B&W Group Ltd.  
Dale Road Worthing  
West Sussex  
BN11 2BH England

