



Service Manufacturing & Supply Co.

Celebrating 60 years of service

33380 Groesbeck Hwy. Fraser, Michigan 48026

(P) 586.415.0455 (F) 586.415.0459

servicemanufacturing.com

Mission

Service Manufacturing & Supply Co. is a wholesale distributor of hydraulic and pneumatic components and accessories serving the fluid power industry.

Core Values

Customer Service ■ Communication ■ Respect ■ Teamwork ■ Quality ■ Accountability

As we are regularly adding to our product line to fit customers' needs we have not included everything that is offered. This condensed catalog showcases our more popular stock and other frequently used items.

Dimensions may change without notice.

Please contact a Customer Service representative if they are critical.

No Minimum Order

\$25.00 and up – No Service Charge
Under \$25.00 - \$2.00 Service Charge
Under \$15.00 - \$4.00 Service Charge

Need help identifying a fitting?

Let a Service Manufacturing Customer Service representative assist you in identifying fittings by determining material, thread type/size, part number, or with a photo.

Shipping Guarantee

We ship same day for all orders placed before 3:30 PM at our distribution center via UPS. Contact customer service to have your order shipped with another carrier.

Damage/ Shortage Claims

Open packages and verify count of all items immediately upon receiving. If damaged, the original carton should be kept for possible carrier inspection. Contact a Customer Service representative within 48 hours of receiving your order to file a claim.

Returns

Returns will be accepted within 30 days of the purchase date. Ask a customer service representative for a Returned Goods Authorization (RGA) and send the items back to our distribution center. A credit will be issued within two weeks of receiving items minus a 25% processing and restocking fee. If an item was a non stock item it may be subjected to additional restocking fees.

(P) 586.415.0455 (F) 586.415.0459

Sales/Identifying Fittings>Returns/Damages/Shortages:
sales@servicemanufacturing.com

accounting@servicemanufacturing.com



Table of Contents

❖ Brass

- **Push-On Hose Barbs.....1**
- **Industrial Hose Barbs.....2-4**
- **Union Type Industrial Hose Barbs.....4**
- **Tube Fittings.....5-7**
- **Brass Pipe Fittings.....8-11**
- **Ball Valves.....11**
- **Compression Fittings.....11**

❖ Steel

- **Pipe Fittings.....12**
- **Suction Hose Barbs.....13**
- **Steel Hydraulic Fitting Cross Reference.....14**
- **Size Chart.....15**
- **Hydraulic Tube Fittings.....16**
- **Hydraulic Pipe Fittings.....17**
- **Hydraulic O-Ring Fittings.....18**

❖ Push-To-Connect

- **Nickel Plated.....19**
- **Plastic.....20**

❖ Lube Block.....21

❖ Manifolds

- **Block Style.....22-25**

- **Hexagon & Octagon Style & Clamps.....26**
- ❖ **Hydro-Craft.....27-30**
- ❖ **Tubing**
 - **Hydraulic.....31-33**
 - **Bundy.....33**
 - **Pneumatic.....34**
- ❖ **Pipe.....35**
- ❖ **Malleable Pipe Fittings.....36**
- ❖ **Hose.....37**
- ❖ **Miscellaneous**
 - **Breather Vents, Exhaust Mufflers.....38**
 - **Grease Fittings.....39**
 - **Tube T-Clips.....39**
 - **Tube Clips.....40**
 - **Oetiker Clamp/Tool.....41**
 - **Hose Cutting Tool.....41**
 - **U-Bolts.....42**
 - **Gauges, Quick Disconnects, Valves.....42**
 - **Thread Sealants.....43**
 - **Product Index.....44-48**



JIC 37° Swivel (PO)



Parker 30682

| Part Number | 37 JIC Swivel Thread | Hose ID |
|-------------|----------------------|---------|
| P0-142 | 7/16-20 | 1/8 |
| P0-144 | 7/16-20 | 1/4 |
| P0-156 | 1/2-20 | 3/8 |
| P0-164 | 9/16-18 | 1/4 |
| P0-166 | 9/16-18 | 3/8 |
| P0-186 | 3/4-16 | 3/8 |
| P0-188 | 3/4-16 | 1/2 |
| P0-1108 | 7/8-14 | 1/2 |
| P0-11010 | 7/8-14 | 5/8 |
| P0-11212 | 1-1/16-12 | 3/4 |
| P0-11616 | 1-5/16-12 | 1" |

Male Pipe (POM)



Parker 30182



*For Female Pipe use part #POF Parker 30282

| Part Number | Hose I.D. | Pipe Thread |
|-------------|-----------|-------------|
| POM-142 | 1/4 | 1/8 |
| POM-144 | 1/4 | 1/4 |
| POM-146 | 1/4 | 3/8 |
| POM-162 | 3/8 | 1/8 |
| POM-164 | 3/8 | 1/4 |
| POM-166 | 3/8 | 3/8 |
| POM-168 | 3/8 | 1/2 |
| POM-186 | 1/2 | 3/8 |
| POM-188 | 1/2 | 1/2 |
| POM-1108 | 5/8 | 1/2 |
| POM-11212 | 3/4 | 3/4 |



Don't forget to order **Continental Push-On** hose which can be found on Pg. 37 or let us build a custom hose for you.

Male 37° JIC (POT)



Parker 30382

| Part Number | Male Thread | Hose I.D. |
|-------------|-------------|-----------|
| POT-142 | 7/16-20 | 1/8 |
| POT-144 | 7/16-20 | 1/4 |
| POT-166 | 9/16-18 | 3/8 |
| POT-188 | 3/4-16 | 1/2 |

Buy Online at www.ServiceManufacturing.com
Customer Service 586.415.0455



Male Pipe Straight (1XX)

| Part Number | Hose I.D. | Pipe | O/A Length |
|-------------|-----------|------|------------|
| 121 | 1/8 | 1/16 | 1-3/16 |
| 142 | 1/4 | 1/8 | 1-9/16 |
| 144 | 1/4 | 1/4 | 1-3/4 |
| 162 | 3/8 | 1/8 | 1-9/16 |
| 164 | 3/8 | 1/4 | 1-3/4 |
| 166 | 3/8 | 3/8 | 1-3/4 |
| 186 | 1/2 | 3/8 | 1-11/16 |
| 188 | 1/2 | 1/2 | 1-7/8 |
| 1108 | 5/8 | 1/2 | 1-13/15 |
| 1128 | 3/4 | 1/2 | 1-25/32 |
| 11212 | 3/4 | 3/4 | 1-13/16 |
| 11616 | 1" | 1" | 2-1/4 |



Parker 125HBL



Remember to order **Oetiker clamps** with industrial hose barbs!

| Oetiker Clamp Number | Hose I.D. |
|----------------------|-----------|
| 1315 | 1/4 |
| 1518 | 3/8 |
| 2023 | 1/2 |
| 2731 | 3/4 |
| 3740 | 1 |

Male Pipe 45° Elbow (4XX)

| Part Number | Hose I.D. | Pipe |
|-------------|-----------|------|
| 432 | 3/16 | 1/8 |
| 442 | 1/4 | 1/8 |
| 444 | 1/4 | 1/4 |
| 452 | 5/16 | 1/8 |
| 454 | 5/16 | 1/4 |
| 462 | 3/8 | 1/8 |
| 464 | 3/8 | 1/4 |
| 466 | 3/8 | 3/8 |
| 486 | 1/2 | 3/8 |
| 488 | 1/2 | 1/2 |



Parker 139HB

Male Pipe 90° Elbow (9XX)

| Part Number | Hose I.D. | Pipe |
|-------------|-----------|------|
| 932 | 3/16 | 1/8 |
| 942 | 1/4 | 1/8 |
| 944 | 1/4 | 1/4 |
| 952 | 5/16 | 1/8 |
| 954 | 5/16 | 1/4 |
| 962 | 3/8 | 1/8 |
| 964 | 3/8 | 1/4 |
| 966 | 3/8 | 3/8 |
| 986 | 1/2 | 3/8 |
| 988 | 1/2 | 1/2 |



Parker 129HB



Buy Online at www.ServiceManufacturing.com

Customer Service 586.415.0455

JIC 37° Swivel (NSBA)



| Part Number | Hose I.D. | Thread Size |
|-------------|-----------|-------------|
| 4-NSBA | 1/4 | 7/16-20 |
| 5-NSBA | 5/16 | 1/2-20 |
| 6-NSBA | 3/8 | 9/16-18 |
| 8-NSBA | 1/2 | 3/4-16 |
| 12-NSBA | 3/4 | 1-1/16-12 |
| 16-NSBA | 1" | 1-5/16-12 |
| 20-NSBA | 1-1/4 | 1-5/8-12 |
| 24-NSBA | 1-1/2 | 1-7/8-12 |

Male JIC 37° (T-1XX)



| Part Number | Thread | Hose I.D. |
|-------------|---------|-----------|
| T-144 | 7/16-20 | 1/4 |
| T-166 | 9/16-18 | 3/8 |

Hose Splicer (HS)



| Part Number | Hose I.D. | O/A Length |
|-------------|-----------|------------|
| HS-4 | 1/4 | 1-5/8 |
| HS-5 | 5/16 | 1-7/8 |
| HS-6 | 3/8 | 2" |
| HS-8 | 1/2 | 2" |

Parker 122 HBL

Buy Online at www.ServiceManufacturing.com
Customer Service 586.415.0455



Male Pipe Straight (U1XX)

| Part Number | Hose I.D. | Pipe |
|-------------|-----------|------|
| U142 | 1/4 | 1/8 |
| U144 | 1/4 | 1/4 |
| U152 | 5/16 | 1/8 |
| U154 | 5/16 | 1/4 |
| U162 | 3/8 | 1/8 |
| U164 | 3/8 | 1/4 |
| U166 | 3/8 | 3/8 |
| U168 | 3/8 | 1/2 |
| U186 | 1/2 | 3/8 |
| U188 | 1/2 | 1/2 |
| U11212 | 3/4 | 3/4 |
| U11616 | 1" | 1" |



Remember to order **Oetiker Clamps** with industrial hose barbs!

| Oetiker Clamp Number | Hose I.D. |
|----------------------|-----------|
| 1315 | 1/4 |
| 1518 | 3/8 |
| 2023 | 1/2 |
| 2731 | 3/4 |
| 3740 | 1 |

Male Pipe 45° (U4XX)

| Part Number | Hose I.D. | Pipe |
|-------------|-----------|------|
| U442 | 1/4 | 1/8 |
| U444 | 1/4 | 1/4 |
| U452 | 5/16 | 1/8 |
| U454 | 5/16 | 1/4 |
| U462 | 3/8 | 1/8 |
| U464 | 3/8 | 1/4 |
| U466 | 3/8 | 3/8 |
| U486 | 1/2 | 3/8 |
| U488 | 1/2 | 1/2 |
| U41212 | 3/4 | 3/4 |
| U41616 | 1" | 1" |



Male Pipe 90° (U9XX)

| Part Number | Hose I.D. | Pipe |
|-------------|-----------|------|
| U942 | 1/4 | 1/8 |
| U944 | 1/4 | 1/4 |
| U952 | 5/16 | 1/8 |
| U954 | 5/16 | 1/4 |
| U962 | 3/8 | 1/8 |
| U964 | 3/8 | 1/4 |
| U966 | 3/8 | 3/8 |
| U986 | 1/2 | 3/8 |
| U988 | 1/2 | 1/2 |
| U91212 | 3/4 | 3/4 |
| U91616 | 1" | 1" |



Buy Online at www.ServiceManufacturing.com

Customer Service 586.415.0455

Male Pipe 45° Elbow (ETM45B)



Parker VTX-B

| Part Number | Thread Size | Pipe Size |
|-------------|-------------|-----------|
| 42-ETM45B | 7/16-20 | 1/8 |
| 44-ETM45B | 7/16-20 | 1/4 |
| 52-ETM45B | 1/2-20 | 1/8 |
| 54-ETM45B | 1/2-20 | 1/4 |
| 62-ETM45B | 9/16-18 | 1/8 |
| 64-ETM45B | 9/16-18 | 1/4 |
| 66-ETM45B | 9/16-18 | 3/8 |
| 86-ETM45B | 3/4-16 | 3/8 |
| 88-ETM45B | 3/4-16 | 1/2 |
| 108-ETM45B | 7/8-14 | 1/2 |
| 1212-ETM45B | 1-1/16-12 | 3/4 |

Male Pipe 90° Elbow Long (LETMB)



Parker CCTX-B

| Part Number | Thread Size | Pipe Size |
|-------------|-------------|-----------|
| 44-LETMB | 7/16-20 | 1/4 |
| 64-LETMB | 9/16-18 | 1/4 |
| 66-LETMB | 9/16-18 | 3/8 |

Male Pipe 90° Elbow (ETMB)



Parker CTX-B

| Part Number | Thread Size | Pipe Size |
|-------------|-------------|-----------|
| 42-ETMB | 7/16-20 | 1/8 |
| 44-ETMB | 7/16-20 | 1/4 |
| 52-ETMB | 1/2-20 | 1/8 |
| 54-ETMB | 1/2-20 | 1/4 |
| 62-ETMB | 9/16-18 | 1/8 |
| 64-ETMB | 9/16-18 | 1/4 |
| 66-ETMB | 9/16-18 | 3/8 |
| 68-ETMB | 9/16-18 | 1/2 |
| 86-ETMB | 3/4-16 | 3/8 |
| 88-ETMB | 3/4-16 | 1/2 |
| 8-12-ETMB | 3/4-16 | 3/4 |
| 108-ETMB | 7/8-14 | 1/2 |
| 12-8-ETMB | 1-1/16-12 | 1/2 |
| 1212-ETMB | 1-1/16-12 | 3/4 |
| 1616-ETMB | 1-5/16-12 | 1" |

Buy Online at www.ServiceManufacturing.com
 Customer Service 586.415.0455



Male Pipe Straight (STMB)

| Part Number | Thread Size | Pipe Size |
|-------------|-------------|-----------|
| 42-STMB | 7/16-20 | 1/8 |
| 44-STMB | 7/16-20 | 1/4 |
| 46-STMB | 7/16-20 | 3/8 |
| 52-STMB | 1/2-20 | 1/8 |
| 54-STMB | 1/2-20 | 1/4 |
| 62-STMB | 9/16-18 | 1/8 |
| 64-STMB | 9/16-18 | 1/4 |
| 66-STMB | 9/16-18 | 3/8 |
| 68-STMB | 9/16-18 | 1/2 |
| 84-STMB | 3/4-16 | 1/4 |
| 86-STMB | 3/4-16 | 3/8 |
| 88-STMB | 3/4-16 | 1/2 |
| 8-12-STMB | 3/4-16 | 3/4 |
| 108-STMB | 7/8-14 | 1/2 |
| 12-8-STMB | 1-1/16-12 | 1/2 |
| 1212-STMB | 1-1/16-12 | 3/4 |
| 1616-STMB | 1-5/16-12 | 1" |



Parker FTX-B

Female Pipe (2405-X-X-Brass)

| Part Number | Thread Size | Pipe Size |
|------------------|-------------|-----------|
| 2405-8-8-BRASS | 3/4-16 | 1/2 |
| 2405-12-12-BRASS | 1-1/16-12 | 3/4 |
| 2405-16-16-BRASS | 1-5/16-12 | 1 |



Parker GTX-B

Straight Union Tube Swivel (UTS-1XX)



Parker F6X-B

| Part Number | Swivel Thread | Pipe Size | O/A Length |
|-------------|---------------|-----------|------------|
| UTS-142 | 7/16-20 | 1/8 | 1-1/8 |
| UTS-144 | 7/16-20 | 1/4 | 1-5/16 |
| UTS-162 | 9/16-18 | 1/8 | 1-3/8 |
| UTS-164 | 9/16-18 | 1/4 | 1-3/8 |
| UTS-166 | 9/16-18 | 3/8 | 1-3/8 |
| UTS-188 | 3/4-16 | 1/2 | 1-13/16 |

45° Elbow Union Tube Swivel (UTS-4XX)



| Part Number | Swivel Thread | Pipe Size |
|-------------|---------------|-----------|
| UTS-444 | 7/16-20 | 1/4 |
| UTS-462 | 9/16-18 | 1/8 |
| UTS-464 | 9/16-18 | 1/4 |
| UTS-466 | 9/16-18 | 3/8 |

90° Union Tube Swivel (UTS-9XX)



Parker X6EF-B

| Part Number | Swivel Thread | Pipe Size |
|-------------|---------------|-----------|
| UTS-942 | 7/16-20 | 1/8 |
| UTS-944 | 7/16-20 | 1/4 |
| UTS-962 | 9/16-18 | 1/8 |
| UTS-964 | 9/16-18 | 1/4 |
| UTS-966 | 9/16-18 | 3/8 |

Buy Online at www.ServiceManufacturing.com
Customer Service 586.415.0455



90° Pipe Elbow (9XX-PE)

| Part Number | Female Pipe | Male Pipe | Center Length |
|------------------------------|-------------|-----------|---------------|
| 922-PE | 1/8 | 1/8 | 1/2 |
| 922 PEL-1 | 1/8 | 1/8 | 1-3/16 |
| 922 PEL-2 | 1/8 | 1/8 | 1-7/16 |
| 922 PEL-3 | 1/8 | 1/8 | 1-11/16 |
| 922 PEL-4 | 1/8 | 1/8 | 1-7/8 |
| 942-PE | 1/4 | 1/8 | 27/32 |
| 944-PE | 1/4 | 1/4 | 27/32 |
| 944 PEL-1 | 1/4 | 1/4 | 1-3/16 |
| 944 PEL-2 | 1/4 | 1/4 | 1-7/16 |
| 944 PEL-3 | 1/4 | 1/4 | 1-11/16 |
| 944 PEL-4 | 1/4 | 1/4 | 1-7/8 |
| 944 PEL-5 | 1/4 | 1/4 | 2-1/4 |
| 966-PE | 3/8 | 3/8 | 31/32 |
| 966 PEL-1 | 3/8 | 3/8 | 1-3/4 |
| 966 PEL-2 | 3/8 | 3/8 | 2-1/4 |
| 988-PE | 1/2 | 1/2 | 1-1/8 |
| Metric Brass Dot El's | | | |
| 92-M6 PE | 1/8 | M6 x .75 | .782 |
| 92-M6-PEL | 1/8 | M6 x .75 | 1.25 |
| 92-M6-PEx1 | 1/8 | M6 x 1.0 | .943 |



Parker 2202P

45° Pipe Elbow (4XX-PE)

| Part Number | Female Pipe | Male Pipe |
|-------------|-------------|-----------|
| 422-PE | 1/8 | 1/8 |
| 422-PEL | 1/8 | 1/8 |
| 444-PE | 1/4 | 1/4 |
| 466-PE | 3/8 | 3/8 |
| 488-PE | 1/2 | 1/2 |



Parker 2214P

Extension Adapter



Parker 222P

| Part Number | Female Pipe | Male Pipe | O/A Length |
|------------------------------|-------------|-----------|------------|
| 12-1032 PA | 1/8 | 10/32 | .940 |
| 122-PA | 1/8 | 1/8 | 13/16 |
| 122-PAL-1 | 1/8 | 1/8 | 1-1/4 |
| 122-PAL-2 | 1/8 | 1/8 | 1-3/4 |
| 122-PAL-3 | 1/8 | 1/8 | 2-11/16" |
| 142-PA | 1/4 | 1/8 | 7/8 |
| 144-PA | 1/4 | 1/4 | 1" |
| 144-PAL | 1/4 | 1/4 | 1-1/4 |
| 144-PAL-1 | 1/4 | 1/4 | 1-9/16 |
| 144-PAL-2 | 1/4 | 1/4 | 1-13/16 |
| 144-PAL-3 | 1/4 | 1/4 | 2-1/16 |
| 144-PAL-4 | 1/4 | 1/4 | 2-1/2 |
| 164-PA | 3/8 | 1/4 | 1-3/16 |
| 166-PA | 3/8 | 3/8 | 1-1/8 |
| 186-PA | 1/2 | 3/8 | 1-11/32 |
| 188-PA | 1/2 | 1/2 | 1-19/64 |
| Metric Brass Adapters | | | |
| 12-M6 PA | 1/8 | M6 x .75 | .710 |
| 12-M6 PAx1 | 1/8 | M6 x 1.0 | .712 |

Restrictor



| Part Number | Male Pipe | Female Pipe | Orifice | O/A Length |
|-------------|-----------|-------------|---------|------------|
| 144-PAR | 1/4 | 1/4 | 1/16 | 1-3/16 |
| 144-PAR-0 | 1/4 | 1/4 | NONE | 1-3/16 |
| 166-PAR-0 | 3/8 | 3/8 | NONE | 1-5/14 |

Buy Online at www.ServiceManufacturing.com
 Customer Service 586.415.0455



Pipe Plugs & Fittings



**Square Head
BPPSQ-Size
Parker 211P**



**Flush Plug
BFCH-Size**



**Hex Head
BPPHH-Size
Parker 218P**



**Counter Sunk
BPPCH-Size
Parker 219P**



**Slotted Plug
BPPSL-Size
Parker 220P**

90° Elbow



**BPE-Size
Parker 2200P**

Hex Reducer Bushing



**BRB-Size
Parker 209P**

Tee



**BPT-Size
Parker 2203P**

Cross



**BPCR-Size
Parker 2205P**

Union



**BPU-Size
Parker 212P**

Male Branch Tee



**MBPT-Size
Parker 2224P**

Coupling



**BPC-Size
Parker 207P/208P**

Hex Nipple



**BHN-Size
Parker 216P**

Bulkhead Coupling



**207ACBH-Size
Parker 207ACBH**

Street Tee



**BPST-Size
Parker 2225P**

Brass Pipe Nipples

Standard sizes are Close through 6 inches

*Other sizes available upon request



Parker 215PN(L)

| Size | Part Number |
|------|-------------|
| 1/8 | 2BN x Size |
| 1/4 | 4BN x Size |
| 3/8 | 6BN x Size |
| 1/2 | 8BN x Size |
| 3/4 | 12BN x Size |
| 1" | 16BN x Size |

Full Port Forged Ball Valves



Stock valve sizes: 1/4" to 3"

Part Number: Size-Ball-Valve

*Other types available upon request

Brass Compression Fittings

Sleeve



60F-Size

Nut



61F-Size

Union



62F-Size

Union Tee



64F-Size

Union Elbow



65F-Size

Female Coupling



66F-Size

Male Coupling



68F-Size

Male Elbow



69F-Size

Female Elbow



70F-Size

Run Tee



71F-Size

Drop Tee



72F-Size

Buy Online at www.ServiceManufacturing.com

Customer Service **586.415.0455**



90° Dot Elbows

| Part Number | Female Pipe | Male Pipe | Center Line | Body Size | O/A Length |
|-------------|-------------|-----------|-------------|-----------|------------|
| 92-428 PE-S | 1/8 | 1/4-28 | 1/2 | 1/2 | 3/4 |
| 92-121 PE-S | 1/8 | 1/16 | 19/32 | 1/2 | 1" |
| 922 PES-S | 1/8 | 1/8 | 9/16 | 1/2 | 7/8 |
| 922 PE-S | 1/8 | 1/8 | 3/4 | 1/2 | 1" |
| 922-PEL-S | 1/8 | 1/8 | 7/8 | 1/2 | 1-1/8 |
| 924 PE-S | 1/8 | 1/4 | 1" | 11/16 | 1-3/8 |
| 944 PE-S | 1/4 | 1/4 | 1" | 11/16 | 1-3/8 |
| 966 PE-S | 3/8 | 3/8 | 1-1/4 | 3/4 | 1-1/2 |
| 988 PE-S | 1/2 | 1/2 | 1-3/8 | 1" | 1-3/4 |



922-PE-S

45° Dot Elbows

| Part Number | Female Pipe | Male Pipe | Center Line | Body Size | O/A Length |
|-------------|-------------|-----------|-------------|-----------|------------|
| 42-428 PE-S | 1/8 | 1/4-28 | 21/32 | 1/2 | 13/16 |
| 422 PE-S | 1/8 | 1/8 | 7/8 | 1/2 | 1" |
| 444 PE-S | 1/4 | 1/4 | 1-1/8 | 11/16 | 1-3/8 |



422-PE-S

Extension Adapters

| Part Number | Female Pipe | Male Pipe | O/A Length |
|--|-------------|-----------|------------|
| 12-1032 PA-S | 1/8 | 10/32 | 5/8 |
| 12-428 PA-S | 1/8 | 1/4-28 | 7/8 |
| 121 PA-S | 1/8 | 1/16 | 7/8 |
| 122 PA-S | 1/8 | 1/8 | 3/4 |
| 122 PAL-S | 1/8 | 1/8 | 1-1/4 |
| 142 PA-S | 1/4 | 1/8 | 1-1/4 |
| 144 PA-S | 1/4 | 1/4 | 1-3/8 |
| 166 PA-S | 3/8 | 3/8 | 1-1/2 |
| Metric Steel Extension Adapters | | | |
| 12-M5-PA-S | 1/8 | M5 | 5/8 |



12-428-PA-S

Parker FG



Buy Online at www.ServiceManufacturing.com

Customer Service 586.415.0455

Male Pipe Barb



| Part Number | Size |
|-------------|-------|
| SM-11212 | 3/4 |
| SM-11616 | 1" |
| SM-12020 | 1-1/4 |
| SM-12424 | 1-1/2 |
| SM-13232 | 2" |

Combination Nipple



| Part Number | Size |
|-------------|-------|
| HAS-3 | 3/4 |
| HAS-4 | 1" |
| HAS-5 | 1-1/4 |
| HAS-6 | 1-1/2 |
| HAS-8 | 2" |
| HAS-10 | 2-1/2 |

37° JIC Swivel Barb

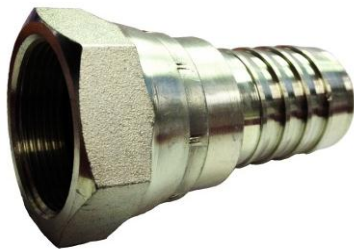

| Part Number | Size |
|-------------|-------|
| SJS-11212 | 3/4 |
| SJS-11616 | 1" |
| SJS-12020 | 1-1/4 |
| SJS-12424 | 1-1/2 |
| SJS-13232 | 2" |

Heavy Duty Clamp



| Part Number | Size |
|-------------|-------|
| HDC-12 | 3/4 |
| HDC-16 | 1" |
| HDC-20 | 1-1/4 |
| HDC-24 | 1-1/2 |
| HDC-32 | 2" |

Buy Online at www.ServiceManufacturing.com
Customer Service 586.415.0455



Steel Fitting Cross Reference

| SMS Steel | Parker Steel | Weather-head | Cross Ref -4 | SMS Steel | Parker Steel | Weather-head | Cross Ref -4 | SMS Steel | Parker Steel | Weather-head | Cross Ref -4 |
|-----------|--------------|--------------|--------------|-----------|--------------|--------------|--------------|-----------------|--------------|--------------|-----------------|
| 304-C | FNTX | 5129 | 820 | 2701 | WETX | 5525 | 833 | 6500 | C6X | 5506 | 622 |
| 306 | WLN | 5924 | 924 | 2702 | WNTX | 5375 | 837 | 6501 | X6EF | 5406 | 627 |
| 318 | BTX | 5105 | 818 | 2703 | WJTX | 55725 | 834 | 6502 | V6X | 5356 | 623 |
| 319 | TX | 5165 | 819 | 2704 | WJTX | 5276 | 835 | 6505 | F60X | 9100 | 618 |
| 1404 | 0107 | 9205 | 604 | 2705 | WGTX | 5275 | 831 | 6506 | G6X | - | 621 |
| 1405 | 0207 | 9255 | 605 | 2706 | WFTX | - | 840 | 6600 | S6X | 5707 | 625 |
| 1501 | 2107 | 9405 | 601 | 5000 | GG | 3309 | 910 | 6602 | R6X | 5706 | 626 |
| 1502 | 2207 | 9455 | 602 | 5404 | FF | 3069 | 911 | 6801 | C50X | 5515 | 522 |
| 1503 | 3107 | 9355 | 606 | 5405 | FG | 3209 | 909 | 6801L | CC50X | 5515L | 522L |
| 1504 | 3207 | 9385 | 607 | 5406 | PTR | 3109 | 912 | 6801LL | CCC50X | 5515LL | 522LL |
| 1601 | 217T | 9406 | 608 | 5406P | HP | 3159 | 932P | 6802 | V50X | 5365 | 523 |
| 1602 | 227T | 9456 | 609 | 5500 | CR | 3529 | 920 | 6803 | S50X | 5715 | 525 |
| 1603 | 077T | 9705 | 603 | 5501 | - | - | 5501 | 6804 | R50X | 5716 | 526 |
| 2403 | HTX | 5305 | 815 | 5502 | CD | 3409 | 914 | 6805 | AEOG | 3459 | 528 |
| 2403LH | LHTX | 5306 | 815LH | 5503 | CD45 | 3359 | 915 | 6806 | - | 3569 | 527 |
| 2404 | FTX | 5205 | 816 | 5504 | DD | 3509 | 916 | 6807 | - | - | C50C50 S |
| 2405 | GTX | 5255 | 854 | 5505 | DD45 | 3559 | 925 | 6809 | AOEX6 | - | 620 |
| 2406 | TRTX | 5015 | 860 | 5602 | MRO | 3759 | 921 | 6900 | 0507 | 9315 | 619 |
| 2408 | PNTX | 5229 | 806 | 5603 | - | 3805 | 923 | 6901 | 2507 | 9515 | 620P |
| 2500 | ETX | 5505 | 821 | 5604 | MMS | 3609 | 922 | 6902 | 3507 | 9365 | 612 |
| 2501 | CTX | 5405 | 822 | 5605 | MMO | 3709 | 917 | SPPCH | HHP/01H P | C3169 | 932 |
| 2501L | CCTX | 5425 | 877 | 5652 | KMMO O | 3959 | 918 | FPSCH | - | - | - |
| 2501LL | CCCTX | 5435 | 878 | 6400 | F50X | 5315 | 516 | SPPSQ | SHP | C3179 | - |
| 2502 | DTX | 5455 | 855 | 6400L | FF50X | 5316 | 516-L | 122-PAS | FG-(R) | C3209 | 909DSS |
| 2503 | VTX | 5355 | 823 | 6401 | F50F | 3249 | 617 | 122-PAL-S | - | - | 909DS |
| 2601 | STX | 5605 | 825 | 6402 | F65X | 5216 | 500 | 122-PAL- 1-S | - | - | 909DL |
| 2602 | OTX | 5655 | 856 | 6404 | FHG5 | 3239 | 509 | 922-PES-S | - | - | 914DSS |
| 2603 | JTX | 5705 | 824 | 6405 | F50G | 3269 | 507 | 9--PE-S | - | - | 914DS |
| 2605 | RTX | 5755 | 826 | 6407 | F50HA0 | 5314 | F50F50S | 9--PEL-S | - | - | 914DL |
| 2606 | MTX | 5805 | 857 | 6408 | P50N | 7237 | 506 | 92-428- PE-S | - | - | 914- 4282-DS |
| 2650 | KTX | 5955 | 827 | 6409 | HP50N | 7238 | 506S | 4--PE-S | - | - | 915DS |
| 2700 | WTX | 5325 | 832 | 6410 | F50G5 | 8033 | 508 | - | - | - | - |

Buy Online at www.ServiceManufacturing.com

Customer Service 586.415.0455

Size Chart

| Nominal Size | Dash Size | National Pipe Thread (NPT) | SAE 37° Flare (JIC) | SAE 45° Flare | O-Ring Boss (ORB) |
|--------------|-----------|----------------------------|---------------------|---------------|-------------------|
|--------------|-----------|----------------------------|---------------------|---------------|-------------------|











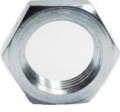























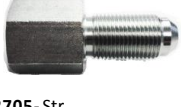

Nominal size usually refers to inside pipe diameter or outside tube diameter.



| | | | | | |
|--------|-----|--------------|-----------|-----------|-----------|
| 1/8" | -02 | 1/8-27 | 5/16-24 | 5/16-24 | 5/16-24 |
| 3/16" | -03 | | 3/8-24 | 3/8-24 | 3/8-24 |
| 1/4" | -04 | 1/4-18 | 7/16-20 | 7/16-20 | 7/16-20 |
| 5/16" | -05 | | 1/2-20 | 1/2-20 | 1/2-20 |
| 3/8" | -06 | 3/8-18 | 9/16-18 | 5/8-18 | 9/16-18 |
| 7/16" | -07 | | | 11/16-16 | |
| 1/2" | -08 | 1/2-14 | 3/4-16 | 3/4-16 | 3/4-16 |
| 5/8" | -10 | | 7/8-14 | 7/8-14 | 7/8-14 |
| 3/4" | -12 | 3/4-14 | 1-1/16-12 | 1-1/16-14 | 1-1/16-12 |
| 7/8" | -14 | | 1-3/16-12 | 1-1/4-12 | 1-3/16-12 |
| 1" | -16 | 1-11-1/2 | 1-5/16-12 | 1-3/8-12 | 1-5/16-12 |
| 1-1/4" | -20 | 1-1/4-11-1/2 | 1-5/8-12 | | 1-5/8-12 |
| 1-1/2" | -24 | 1-1/2-11-1/2 | 1-7/8-12 | | 1-7/8-12 |
| 2" | -32 | 2-11-1/2 | 2-1/2-12 | | 2-1/2-12 |

Buy Online at www.ServiceManufacturing.com
Customer Service 586.415.0455



























| | | | | | |
|--|---|---|---|--|--|
| <p>Nuts, Sleeves, Locknuts</p> |  <p>304-C- Cap Nut</p> |  <p>306- Bulkhead Locknut</p> |  <p>318- Tube Nut</p> |  <p>319- Tube Sleeve</p> |  |
| <p>Straights</p> |  <p>2403- (1&2) Male Tube Union</p> |  <p>2403-LH- (Large Hex) (1&2) Male Tube Union</p> |  <p>2404- (1) Male Tube (2) Male Pipe</p> |  <p>2404-L- (Long) (1) Male Tube (2) Male Pipe</p> |  <p>2404-LL- (Ex-Long) (1) Male Tube (2) Male Pipe</p> |
|  <p>2405- (1) Male Tube (2) Female Pipe</p> |  <p>2406-Reducer (1) 37° Female (2) Male Tube</p> |  <p>2408-Plug (1) Male Tube</p> | <p>Elbows</p> |  <p>2500-90° (1&2) Male Tube</p> |  <p>2501-90° (1) Male Tube (2) Male Pipe</p> |
|  <p>2501-L 90° (Long) (1) Male Tube (2) Male Pipe</p> |  <p>2501-LL 90° (Ex-Long) (1) Male Tube (2) Male Pipe</p> |  <p>2502-90° (1) Male Tube (2) Female Pipe</p> |  <p>2503-45° (1) Male Tube (2) Male Pipe</p> | <p>Tees, Crosses</p> |  <p>2601-Tee (1 & 2) Male Tube (3) Male Pipe</p> |
|  <p>2602-Tee (1 & 2) Male Tube (3) Female Pipe</p> |  <p>2603-Tee (1, 2, & 3) Male Tube</p> |  <p>2605-Tee (1&3) Male Tube (2) Male Pipe</p> |  <p>2606-Tee (1 & 3) Male Tube (2) Female Pipe</p> |  <p>2650-Cross (1, 2, 3, & 4) Male Tube</p> | |
| <p>Bulkheads</p> |  <p>2700-Str. (1) Male Tube (2) Bulkhead</p> |  <p>2701-90° (1) Male Tube (2) Bulkhead</p> |  <p>2702-45° (1) Male Tube (2) Bulkhead</p> |  <p>2705-Str. (1) Female Pipe (2) Bulkhead</p> |  <p>2706-Str. (1) Male Pipe (2) Bulkhead</p> |
| <p>Swivels</p> |  <p>6500-90° (1) Male Tube (2) 37° Female Swivel</p> |  <p>6501-90° (1) Male Pipe (2) 37° Female Swivel</p> |  <p>6502-45° (1) Male Tube (2) 37° Female Swivel</p> |  <p>6504-Str. (1) Male Tube (2) 37° Female Swivel</p> |  <p>6505-Str. (1) Male Pipe (2) 37° Female Swivel</p> |
|  <p>6506-Str. (1) Female Pipe (2) 37° Female Swivel</p> |  <p>6600-Tee (1 & 2) Male Tube (3) 37° Female Swivel</p> |  <p>6602-Tee (1 & 3) Male Tube (2) 37° Female Swivel</p> | | | |



| | | | | | |
|--|---|--|---|---|---|
| <p>Adapter Unions</p> |  <p>1404- Str. (1) Male Pipe (2) Female Pipe Swivel</p> |  <p>1405- Str. (1) Female Pipe (2) Female Pipe Swivel</p> |  <p>1501- 90° (1) Male Pipe (2) Female Pipe Swivel</p> |  <p>1502- 90° (1) Female Pipe (2) Female Pipe Swivel</p> |  |
|  <p>1503- 45° (1) Male Pipe (2) Female Pipe Swivel</p> |  <p>1601- Tee (1) Male Pipe (2 & 3) Female Pipe Swivel</p> | <p>Straights</p> |  <p>5000- Str. (1 & 2) Female Pipe</p> |  <p>5404- Str. (1 & 2) Male Pipe</p> |  <p>5405- Str. Reducer (1) Male Pipe (2) Female Pipe</p> |
|  <p>5406- Bushing (1) Male Pipe (2) Female Pipe</p> | <p>Plugs</p> |  <p>5406-P- Ext. Hex Plug (1) Male Pipe</p> |  <p>SPPCH- Hex Socket (1) Male Pipe</p> |  <p>FPSCH- Flush Plug (1) Male Pipe</p> |  <p>SPPSQ- Square Head (1) Male Pipe</p> |
| <p>Elbows</p> |  <p>5500- 90° (1 & 2) Male Pipe</p> |  <p>5502- 90° (1) Male Pipe (2) Female Pipe</p> |  <p>5503- 45° (1) Male Pipe (2) Female Pipe</p> |  <p>5504- 90° (1 & 2) Female Pipe</p> |  <p>5505- 45° (1 & 2) Female Pipe</p> |
| <p>Tees, Crosses</p> |  <p>5602- Tee (1) Male Pipe (2 & 3) Female Pipe</p> |  <p>5603- Tee (1 & 3) Male Pipe (2) Female Pipe</p> |  <p>5604- Tee (1 & 2) Female Pipe (3) Male Pipe</p> |  <p>5605- Tee (1, 2, & 3) Female Pipe</p> |  <p>5652- Cross (1, 2, 3, & 4) Female Pipe</p> |

Buy Online at www.ServiceManufacturing.com
Customer Service 586.415.0455



| | | | | | |
|---|--|--|---|---|---|
|  |  <p>6400-Str. (1) Male Tube (2) Male O-Ring</p> |  <p>6401-Str. (1) Male O-Ring (2) Male Pipe</p> |  <p>6402-Str. (1) Male O-Ring (2) 37° Female Swivel</p> |  <p>6404-Str. (1) Female O-Ring (2) Male Pipe</p> | |
| |  <p>6405-Str. (1) Male O-Ring (2) Female Pipe</p> |  <p>6407-Str. (1) Male O-Ring (2) Adjustable O-Ring</p> |  <p>6408-Plug (1) Male O-Ring-Ext. Hex</p> |  <p>6409-Plug (1) Male O-Ring-Int. Hex</p> |  <p>6410-90° (1) Male O-Ring (2) Female O-Ring</p> |
|  |  <p>6801-90° (1) Male Tube (2) Adjustable O-Ring</p> |  <p>6801-L-90° (Long) (1) Male Tube (2) Adjustable O-Ring</p> |  <p>6801-LL-90° (Ex-Long) (1) Male Tube (2) Adjustable O-Ring</p> |  <p>6802-45° (1) Male Tube (2) Adjustable O-Ring</p> |  <p>6805-90° (1) Adjustable O-Ring (2) Female Pipe</p> |
| |  <p>6806-90° (1) Adjustable O-Ring (2) Male Pipe</p> |  <p>6807-90° (1 & 2) Adjustable O-Ring</p> |  <p>6808-45° (1 & 2) Adjustable O-Ring</p> |  <p>6809-90° (1) Adjustable O-Ring (2) 37° Female Swivel</p> |  <p>6901-90° (1) Adjustable O-Ring (2) Female Pipe Swivel</p> |
|  |  <p>6803-Tee (1 & 2) Male Tube (3) Adjustable O-Ring</p> |  <p>6804-Tee (1 & 3) Male Tube (2) Adjustable O-Ring</p> | | | |

Nickel Plated Brass Straights

Straight Union



562-X1-X1

Female Connector



566-X1-X2

Bulkhead Union



582-X1-X1

Male Connector



P568-X1-X2

Nickel Plated Brass 90°

Union Elbow



565-X1-X1

Male Elbow



569-X1-X2

Male Swivel Elbow



579-X1-X2

- X1= Tube Size
- X2= Pipe Thread

Nickel Plated Brass Tee

Union Tee



564-X1-X1

Male Swivel Run Tee



571-X1-X2

Male Swivel Branch Tee



572-X1-X2

Buy Online at www.ServiceManufacturing.com
Customer Service 586.415.0455



Plastic Male Swivel

Male Swivel Run Tee



P571-X1-X2

Male Swivel Elbow



P579-X1-X2

Union Y Male Swivel



P543-X1-X2

Male Swivel Branch Tee



P572-X1-X2

- X1= Tube Size
- X2= Pipe Thread

Plastic Union

Straight Union



P562-X1-X1

Y Union



P541-X1-X1

Union Tee



P564-X1-X1



Buy Online at www.ServiceManufacturing.com
Customer Service 586.415.0455

25 Hole 90° Header Block

| Material | Part Number | Thread Size |
|----------|-------------|-------------|
| Aluminum | J21613A | 1/8 NPTF |
| Aluminum | J21113A | 1/4 NPTF |
| Steel | J21613 | 1/8 NPTF |
| Steel | J21113 | 1/4 NPTF |

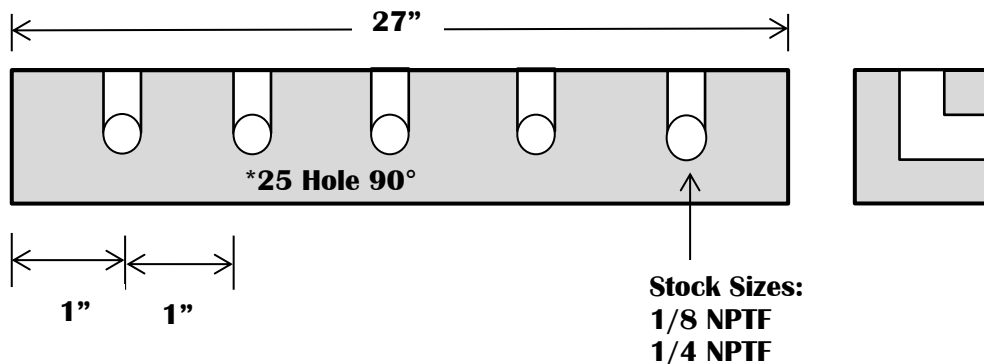

25 Hole 180° Header Block

| Material | Part Number | Thread Size |
|----------|-------------|-------------|
| Aluminum | J21612A | 1/8 NPTF |
| Aluminum | J21112A | 1/4 NPTF |
| Steel | J21612 | 1/8 NPTF |
| Steel | J21112 | 1/4 NPTF |

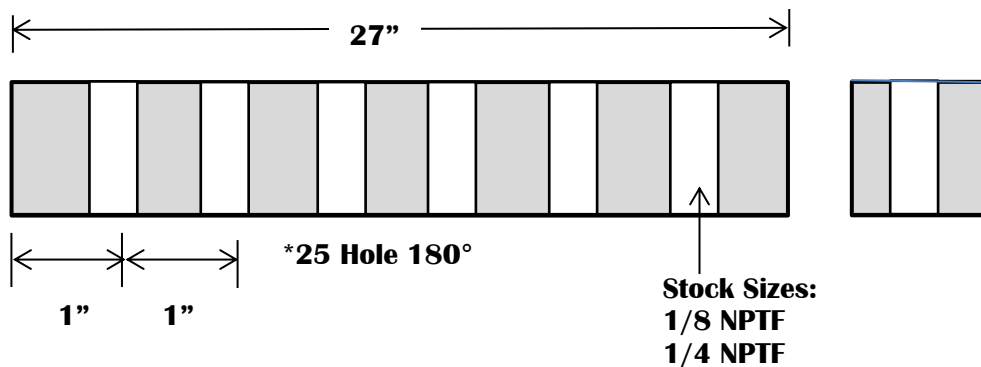

Header Blocks can be manufactured to your specifications including number & size of ports, tee shape ports, SAE, BSPP, and BSPT ports, for immediate delivery.

Buy Online at www.ServiceManufacturing.com
Customer Service 586.415.0455



2 & 3 Port Aluminum

Multi-feed, tee shape ports, SAE, BSPP, BSPT, and other custom manifolds available upon request.

*For a 90° add a -90 to the end of the part number

| Part Number | Inlet Size (NPT) | Number of Ports | Port Size (NPT) | Overall Length |
|-------------|------------------|-----------------|-----------------|----------------|
| SM4-2-2 | 1/4 | 2 | 1/8 | 1.75 |
| SM6-2-2 | 3/8 | 2 | 1/8 | 2.37 |
| SM6-2-4 | 3/8 | 2 | 1/4 | 2.37 |
| SMS-2-4 | 1/2 | 2 | 1/4 | 2.75 |
| SMS-2-6 | 1/2 | 2 | 3/8 | 2.75 |
| SAM4-2-2 | 1/4 | 2 | 1/8 | 3.25 |
| SAM6-2-2 | 3/8 | 2 | 1/8 | 3.25 |
| SAM6-2-4 | 3/8 | 2 | 1/4 | 3.25 |
| SAMS-2-4 | 1/2 | 2 | 1/4 | 3.25 |
| SAMS-2-6 | 1/2 | 2 | 3/8 | 3.25 |
| SM16-2-4 | 1" | 2 | 1/4 | 5.25 |
| SM16-2-6 | 1" | 2 | 3/8 | 5.25 |
| SM16-2-8 | 1" | 2 | 1/2 | 5.25 |
| SM16-2-12 | 1" | 2 | 3/4 | 6.00 |
| SM20-2-4 | 1-1/4" | 2 | 1/4 | 5.25 |
| SM20-2-6 | 1-1/4" | 2 | 3/8 | 5.25 |
| SM20-2-8 | 1-1/4" | 2 | 1/2 | 5.25 |
| SM20-2-12 | 1-1/4" | 2 | 3/4 | 6.00 |
| | | | | |
| SM4-3-2 | 1/4 | 3 | 1/8 | 2.50 |
| SM6-3-2 | 3/8 | 3 | 1/8 | 3.25 |
| SM6-3-4 | 3/8 | 3 | 1/4 | 3.25 |
| SMS-3-4 | 1/2 | 3 | 1/4 | 3.75 |
| SMS-3-6 | 1/2 | 3 | 3/8 | 3.75 |
| SAM4-3-2 | 1/4 | 3 | 1/8 | 4.75 |
| SAM6-3-2 | 3/8 | 3 | 1/8 | 4.75 |
| SAM6-3-4 | 3/8 | 3 | 1/4 | 4.75 |
| SAMS-3-4 | 1/2 | 3 | 1/4 | 4.75 |
| SAMS-3-6 | 1/2 | 3 | 3/8 | 4.75 |
| SM16-3-4 | 1" | 3 | 1/4 | 7.50 |
| SM16-3-6 | 1" | 3 | 3/8 | 7.50 |
| SM16-3-8 | 1" | 3 | 1/2 | 7.50 |
| SM16-3-12 | 1" | 3 | 3/4 | 9.00 |
| SM20-3-4 | 1-1/4" | 3 | 1/4 | 7.50 |
| SM20-3-6 | 1-1/4" | 3 | 3/8 | 7.50 |
| SM20-3-8 | 1-1/4" | 3 | 1/2 | 7.50 |
| SM20-3-12 | 1-1/4" | 3 | 3/4 | 9.00 |



Buy Online at www.ServiceManufacturing.com

Customer Service 586.415.0455

4 & 5 Port Aluminum

| Part Number | Inlet Size (NPT) | Number of Ports | Port Size (NPT) | Overall Length |
|-------------|------------------|-----------------|-----------------|----------------|
| SM4-4-2 | 1/4 | 4 | 1/8 | 3.25 |
| SM6-4-2 | 3/8 | 4 | 1/8 | 4.12 |
| SM6-4-4 | 3/8 | 4 | 1/4 | 4.12 |
| SMS-4-4 | 1/2 | 4 | 1/4 | 4.75 |
| SMS-4-6 | 1/2 | 4 | 3/8 | 4.75 |
| SAM4-4-2 | 1/4 | 4 | 1/8 | 6.25 |
| SAM6-4-2 | 3/8 | 4 | 1/8 | 6.25 |
| SAM6-4-4 | 3/8 | 4 | 1/4 | 6.25 |
| SAMS-4-4 | 1/2 | 4 | 1/4 | 6.25 |
| SAMS-4-6 | 1/2 | 4 | 3/8 | 6.25 |
| SM16-4-4 | 1" | 4 | 1/4 | 9.75 |
| SM16-4-6 | 1" | 4 | 3/8 | 9.75 |
| SM16-4-8 | 1" | 4 | 1/2 | 9.75 |
| SM16-4-12 | 1" | 4 | 3/4 | 12.00 |
| SM20-4-4 | 1-1/4" | 4 | 1/4 | 9.75 |
| SM20-4-6 | 1-1/4" | 4 | 3/8 | 9.75 |
| SM20-4-8 | 1-1/4" | 4 | 1/2 | 9.75 |
| SM20-4-12 | 1-1/4" | 4 | 3/4 | 12.00 |
| | | | | |
| SM4-5-2 | 1/4 | 5 | 1/8 | 4.00 |
| SM6-5-2 | 3/8 | 5 | 1/8 | 5.00 |
| SM6-5-4 | 3/8 | 5 | 1/4 | 5.00 |
| SMS-5-4 | 1/2 | 5 | 1/4 | 5.75 |
| SMS-5-6 | 1/2 | 5 | 3/8 | 5.75 |
| SAM4-5-2 | 1/4 | 5 | 1/8 | 7.50 |
| SAM6-5-2 | 3/8 | 5 | 1/8 | 7.50 |
| SAM6-5-4 | 3/8 | 5 | 1/4 | 7.75 |
| SAMS-5-4 | 1/2 | 5 | 1/4 | 7.75 |
| SAMS-5-6 | 1/2 | 5 | 3/8 | 7.75 |
| SM16-5-4 | 1" | 5 | 1/4 | 12.00 |
| SM16-5-6 | 1" | 5 | 3/8 | 12.00 |
| SM16-5-8 | 1" | 5 | 1/2 | 12.00 |
| SM16-5-12 | 1" | 5 | 3/4 | 15.00 |
| SM20-5-4 | 1-1/4" | 5 | 1/4 | 12.00 |
| SM20-5-6 | 1-1/4" | 5 | 3/8 | 12.00 |
| SM20-5-8 | 1-1/4" | 5 | 1/2 | 12.00 |
| SM20-5-12 | 1-1/4" | 5 | 3/4 | 15.00 |

Buy Online at www.ServiceManufacturing.com
 Customer Service 586.415.0455



6 & 7 Port Aluminum

| Part Number | Inlet Size (NPT) | Number of Ports | Port Size (NPT) | Overall Length |
|-------------|------------------|-----------------|-----------------|----------------|
| SM4-6-2 | 1/4 | 6 | 1/8 | 4.75 |
| SM6-6-2 | 3/8 | 6 | 1/8 | 5.88 |
| SM6-6-4 | 3/8 | 6 | 1/4 | 5.88 |
| SMS-6-4 | 1/2 | 6 | 1/4 | 6.75 |
| SMS-6-6 | 1/2 | 6 | 3/8 | 6.75 |
| SAM4-6-2 | 1/4 | 6 | 1/8 | 9.25 |
| SAM6-6-2 | 3/8 | 6 | 1/8 | 9.25 |
| SAM6-6-4 | 3/8 | 6 | 1/4 | 9.25 |
| SAMS-6-4 | 1/2 | 6 | 1/4 | 9.25 |
| SAMS-6-6 | 1/2 | 6 | 3/8 | 9.25 |
| SM16-6-4 | 1" | 6 | 1/4 | 14.25 |
| SM16-6-6 | 1" | 6 | 3/8 | 14.25 |
| SM16-6-8 | 1" | 6 | 1/2 | 14.25 |
| SM16-6-12 | 1" | 6 | 3/4 | 18.00 |
| SM20-6-4 | 1-1/4" | 6 | 1/4 | 14.25 |
| SM20-6-6 | 1-1/4" | 6 | 3/8 | 14.25 |
| SM20-6-8 | 1-1/4" | 6 | 1/2 | 14.25 |
| SM20-6-12 | 1-1/4" | 6 | 3/4 | 18.00 |
| <hr/> | | | | |
| SM4-7-2 | 1/4 | 7 | 1/8 | 5.50 |
| SM6-7-2 | 3/8 | 7 | 1/8 | 6.75 |
| SM6-7-4 | 3/8 | 7 | 1/4 | 6.75 |
| SMS-7-4 | 1/2 | 7 | 1/4 | 7.75 |
| SMS-7-6 | 1/2 | 7 | 3/8 | 7.75 |
| SAM4-7-2 | 1/4 | 7 | 1/8 | 10.75 |
| SAM6-7-2 | 3/8 | 7 | 1/8 | 10.75 |
| SAM6-7-4 | 3/8 | 7 | 1/4 | 10.75 |
| SAMS-7-4 | 1/2 | 7 | 1/4 | 10.75 |
| SAMS-7-6 | 1/2 | 7 | 3/8 | 10.75 |
| SM16-7-4 | 1" | 7 | 1/4 | 10.75 |
| SM16-7-6 | 1" | 7 | 3/8 | 16.50 |
| SM16-7-8 | 1" | 7 | 1/2 | 16.50 |
| SM16-7-12 | 1" | 7 | 3/4 | 21.00 |
| SM20-7-4 | 1-1/4" | 7 | 1/4 | 16.50 |
| SM20-7-6 | 1-1/4" | 7 | 3/8 | 16.50 |
| SM20-7-8 | 1-1/4" | 7 | 1/2 | 16.50 |
| SM20-7-12 | 1-1/4" | 7 | 3/4 | 21.00 |

Buy Online at www.ServiceManufacturing.com

Customer Service 586.415.0455

8, 9, & 10 Port Manifolds

| Part Number | Inlet Size (NPT) | Number of Ports | Port Size (NPT) | Overall Length |
|-------------|------------------|-----------------|-----------------|----------------|
| SM4-8-2 | 1/4 | 8 | 1/8 | 6.25 |
| SM6-8-2 | 3/8 | 8 | 1/8 | 7.62 |
| SM6-8-4 | 3/8 | 8 | 1/4 | 7.62 |
| SMS-8-4 | 1/2 | 8 | 1/4 | 8.75 |
| SMS-8-6 | 1/2 | 8 | 3/8 | 8.75 |
| SAM4-8-2 | 1/4 | 8 | 1/8 | 12.25 |
| SAM6-8-2 | 3/8 | 8 | 1/8 | 12.25 |
| SAM6-8-4 | 3/8 | 8 | 1/4 | 12.25 |
| SAMS-8-4 | 1/2 | 8 | 1/4 | 12.25 |
| SAMS-8-6 | 1/2 | 8 | 3/8 | 12.25 |
| SM16-8-4 | 1" | 8 | 1/4 | 18.75 |
| SM16-8-6 | 1" | 8 | 3/8 | 18.75 |
| SM16-8-8 | 1" | 8 | 1/2 | 18.75 |
| SM16-8-12 | 1" | 8 | 3/4 | 24.00 |
| SM20-8-4 | 1-1/4" | 8 | 1/4 | 18.75 |
| SM20-8-6 | 1-1/4" | 8 | 3/8 | 18.75 |
| SM20-8-8 | 1-1/4" | 8 | 1/2 | 18.75 |
| SM20-8-12 | 1-1/4" | 8 | 3/4 | 24.00 |
| <hr/> | | | | |
| SM4-9-2 | 1/4 | 9 | 1/8 | 7.00 |
| SM6-9-2 | 3/8 | 9 | 1/8 | 8.50 |
| SM6-9-4 | 3/8 | 9 | 1/4 | 8.50 |
| SMS-9-4 | 1/2 | 9 | 1/4 | 9.75 |
| SMS-9-6 | 1/2 | 9 | 3/8 | 9.75 |
| SAM4-9-2 | 1/4 | 9 | 1/8 | 13.75 |
| SAM6-9-2 | 3/8 | 9 | 1/8 | 13.75 |
| SAM6-9-4 | 3/8 | 9 | 1/4 | 13.75 |
| SAMS-9-4 | 1/2 | 9 | 1/4 | 13.75 |
| SAMS-9-6 | 1/2 | 9 | 3/8 | 13.75 |
| <hr/> | | | | |
| SM4-10-2 | 1/4 | 10 | 1/8 | 7.75 |
| SM6-10-2 | 3/8 | 10 | 1/8 | 9.38 |
| SM6-10-4 | 3/8 | 10 | 1/4 | 9.38 |
| SMS-10-4 | 1/2 | 10 | 1/4 | 10.75 |
| SMS-10-6 | 1/2 | 10 | 3/8 | 10.75 |
| SAM4-10-2 | 1/4 | 10 | 1/8 | 15.25 |
| SAM6-10-2 | 3/8 | 10 | 1/8 | 15.25 |
| SAM6-10-4 | 3/8 | 10 | 1/4 | 15.25 |
| SAMS-10-4 | 1/2 | 10 | 1/4 | 15.25 |
| SAMS-10-6 | 1/2 | 10 | 3/8 | 15.25 |

Buy Online at www.ServiceManufacturing.com
 Customer Service 586.415.0455



Hexagon & Octagon Manifolds & Clams

| Part Number | Inlet Size (NPT) | Number of Ports | Port Size (NPT) | Overall Length |
|-----------------------------|------------------------------------|-----------------|-----------------|----------------|
| OFFSET PORT | | | | |
| SMA13-84 | 3/4 | 8 | 1/4 | 10.50 |
| SMA13-86 | 3/4 | 8 | 3/8 | 10.50 |
| SMB12-84 * | 1 | 8 | 1/4 | 10.50 |
| SMB12-86 * | 1 | 8 | 3/8 | 10.50 |
| SMC13-84 | 1-1/4 | 8 | 1/4 | 11.00 |
| SMC13-86 | 1-1/4 | 8 | 3/8 | 11.00 |
| SMD12-86 * | 1-1/2 | 8 | 3/8 | 11.00 |
| SMD12-88 * | 1-1/2 | 8 | 1/2 | 11.00 |
| SMA13-164 | 3/4 | 16 | 1/4 | 18.50 |
| SMA13-166 | 3/4 | 16 | 3/8 | 18.50 |
| SMB12-164 * | 1 | 16 | 1/4 | 18.50 |
| SMB12-166 * | 1 | 16 | 3/8 | 18.50 |
| SMC13-164 | 1-1/4 | 16 | 1/4 | 19.00 |
| SMC13-166 | 1-1/4 | 16 | 3/8 | 19.00 |
| SMD12-166 * | 1-1/2 | 16 | 3/8 | 19.00 |
| SMD12-168 * | 1-1/2 | 16 | 1/2 | 19.00 |
| STRAIGHT INLINE PORT | | | | |
| SMA1-44 | 3/4 | 4 | 1/4 | 10.50 |
| SMA1-46 | 3/4 | 4 | 3/8 | 10.50 |
| SMB1-44 * | 1 | 4 | 1/4 | 10.50 |
| SMB1-46 * | 1 | 4 | 3/8 | 10.50 |
| SMC1-44 | 1-1/4 | 4 | 1/4 | 11.00 |
| SMC1-46 | 1-1/4 | 4 | 3/8 | 11.00 |
| SMD1-46 * | 1-1/2 | 4 | 3/8 | 11.00 |
| SMD1-48 * | 1-1/2 | 4 | 1/2 | 11.00 |
| SMA1-84 | 3/4 | 8 | 1/4 | 18.50 |
| SMA1-86 | 3/4 | 8 | 3/8 | 18.50 |
| SMB1-84 * | 1 | 8 | 1/4 | 18.50 |
| SMB1-86 * | 1 | 8 | 3/8 | 18.50 |
| SMC1-84 | 1-1/4 | 8 | 1/4 | 19.00 |
| SMC1-86 | 1-1/4 | 8 | 3/8 | 19.00 |
| SMD1-86 * | 1-1/2 | 8 | 3/8 | 19.00 |
| SMD1-88 * | 1-1/2 | 8 | 1/2 | 19.00 |
| CLAMPS | | | | |
| SMA-C * | Use on manifolds with 3/4" inlet | | | |
| SMB-C * | Use on manifolds with 1" inlet | | | |
| SMC-C | Use on manifolds with 1-1/4" inlet | | | |
| SMD-C | Use on manifolds with 1-1/2" inlet | | | |

*Hexagon Manifolds are indicated with an asterisk. All others are the Octagon Style. Some styles may no longer be available. Call a customer service representative for information on current offerings.



Buy Online at www.ServiceManufacturing.com

Customer Service 586.415.0455



37° Male Junction Adapter



| Part Number | Tube Size |
|-------------|-----------|
| B-10-4 | 1/4 |
| B-10-6 | 3/8 |
| B-10-8 | 1/2 |
| B-10-10 | 5/8 |
| B-16-4 | 1/4 |
| B-16-6 | 3/8 |
| B-16-8 | 1/2 |
| B-16-10 | 5/8 |
| B-16-12 | 3/4 |
| B-16-14 | 7/8 |
| B-16-16 | 1 |

The B-10 is used with the HC-10 series clamp and the B-16 is used with the HC-16 series or HC-32 if using the Multi-Clamp Bulkhead spacer.
*Part # HC-32-BS-16

Female Junction Adapter



| Part Number | Thread Size |
|-------------|---------------|
| BSAE-10-8 | 3/4-16 SAE |
| BSAE-16-12 | 1-1/16-12 SAE |
| BSAE-32-20 | 1-5/8-12 SAE |



Clamping Unit



| Part Number | Overall Length | Number of Holes |
|-------------|----------------|-----------------|
| HC-10-2 | 2-15/16 | 2 |
| HC-10-3 | 4-13/32 | 3 |
| HC-10-4 | 5-15/16 | 4 |
| HC-10-5 | 7-9/64 | 5 |
| HC-10-6 | 8-15/16 | 6 |
| HC-10-7 | 10-3/16 | 7 |
| HC-10-32 | 48 | 32 |
| HC-16-2 | 3-7/8 | 2 |
| HC-16-3 | 5-41/64 | 3 |
| HC-16-4 | 7-57/64 | 4 |
| HC-16-5 | 9-43/64 | 5 |
| HC-16-6 | 11-43/64 | 6 |
| HC-16-7 | 13-5/8 | 7 |
| HC-16-24 | 48 | 24 |
| HC-32-2 | 6-49/64 | 2 |
| HC-32-3 | 8-45/64 | 3 |
| HC-32-4 | 11-45/64 | 4 |
| HC-32-5 | 14-45/64 | 5 |
| HC-32-6 | 17-45/64 | 6 |
| HC-32-16 | 48 | 16 |

Buy Online at www.ServiceManufacturing.com
Customer Service 586.415.0455





Clamping Unit With Outside Mounting Holes

| Part Number | Overall Length | Number of Holes |
|-------------|----------------|-----------------|
| HC-10-1-2 | 2-3/16 | 1 |
| HC-10-2-3 | 3-51/64 | 2 |
| HC-10-3-4 | 5-19/64 | 3 |
| HC-10-4-5 | 6-51/64 | 4 |
| HC-10-5-6 | 8-19/64 | 5 |
| HC-16-1-2 | 2-21/32 | 1 |
| HC-16-2-3 | 4-49/64 | 2 |
| HC-16-3-4 | 6-51/64 | 3 |
| HC-16-4-5 | 8-51/64 | 4 |
| HC-32-1-2 | 4 | 1 |
| HC-32-2-3 | 6-55/64 | 2 |
| HC-32-3-4 | 9-55/64 | 3 |
| HC-32-4-5 | 12-55/64 | 4 |

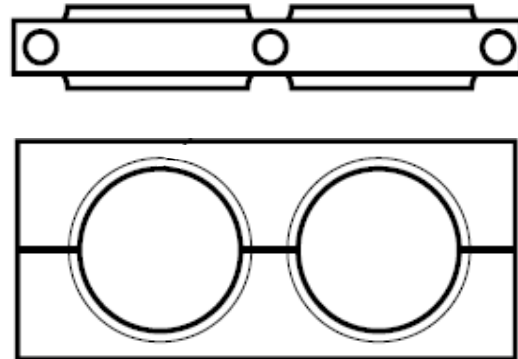

Split Bushing For Tube & Pipe

| Part Number | Tube Size | Clamp series | Pieces Per Bag |
|-------------|-----------|--------------|----------------|
| G-10-3 | 3/16 | HC-10 | 35 |
| G-10-4 | 1/4 | HC-10 | 35 |
| G-10-5 | 5/16 | HC-10 | 35 |
| G-10-6 | 3/8 | HC-10 | 35 |
| G-10-8 | 1/2 | HC-10 | 35 |
| G-10-10 | 5/8 | HC-10 | 35 |
| G-10-12 | 3/4 | HC-10 | 35 |
| G-16-4* | 1/4 | HC-16 | 25 |
| G-16-5 | 5/16 | HC-16 | 25 |
| G-16-6* | 3/8 | HC-16 | 25 |
| G-16-8* | 1/2 | HC-16 | 25 |
| G-16-10 | 5/8 | HC-16 | 25 |
| G-16-12* | 3/4 | HC-16 | 25 |
| G-16-14 | 7/8 | HC-16 | 25 |
| G-16-16 | 1 | HC-16 | 25 |

Part numbers with a * at the end are also available for **Pipe**. When ordering add **-P** to the part number.

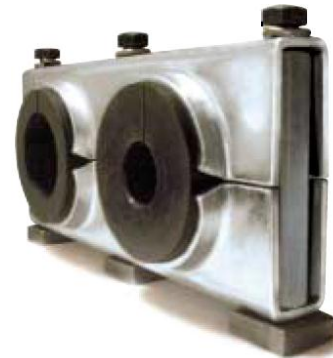

Split Bushings Sold in Bag Quantity

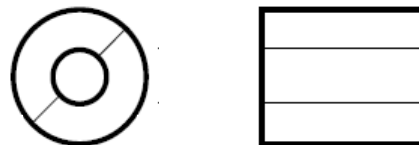

Split Bushing For Tube & Pipe



| Part Number | Tube Size | Clamp Series | Pieces Per Bag |
|-------------|-----------|--------------|----------------|
| G-32-4* | 1/4 | HC-32 | 12 |
| G-32-6* | 3/8 | HC-32 | 12 |
| G-32-8* | 1/2 | HC-32 | 12 |
| G-32-10 | 5/8 | HC-32 | 12 |
| G-32-12* | 3/4 | HC-32 | 12 |
| G-32-14 | 7/8 | HC-32 | 12 |
| G-32-16* | 1 | HC-32 | 12 |
| G-32-20* | 1-1/4 | HC-32 | 12 |
| G-32-24* | 1-1/2 | HC-32 | 12 |
| G-32-28 | 1-3/4 | HC-32 | 12 |
| G-32-32 | 2 | HC-32 | 12 |

Part numbers with a * at the end are also available for **Pipe**. When ordering add **-P** to the part number

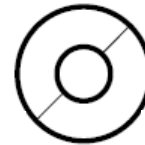

Split Bushings Sold in Bag Quantity

Socket-Head Stacking Nut, Thread & Weld Adapter



N-



T-

| Stacking Nut | Thread Adapter | Weld Adapter | Clamp Series |
|--------------|----------------|--------------|--------------|
| N-10 | T-10 | W-10 | HC-10 |
| N-16 | T-10 | W-16 | HC-16 |
| N-32 | T-32 | W-32 | HC-32 |

Stacking Nuts & Thread Adapters are sold in bag quantities. N-10, N-16, T-10, & T-32 have 50 pieces per bag. N-32 has 25 pieces per bag.

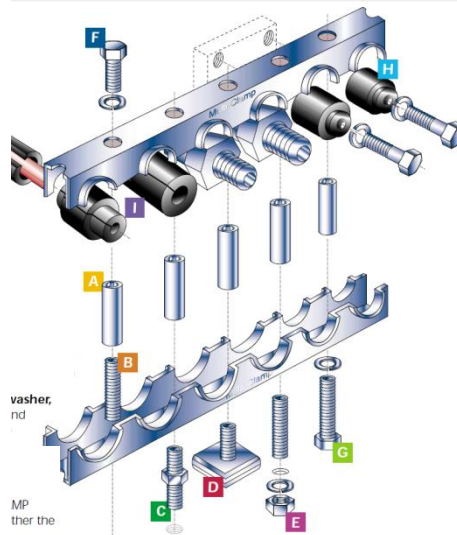

Buy Online at www.ServiceManufacturing.com
 Customer Service 586.415.0455





Walker-Strut Clamp

| Part Number | Tube Size |
|-------------|-----------|
| WS-04* | 1/4 |
| WS-06* | 3/8 |
| WS-08* | 1/2 |
| WS-10 | 5/8 |
| WS-12* | 3/4 |
| WS-14 | 7/8 |
| WS-16* | 1 |
| WS-18 | 1-1/8 |
| WS-20* | 1-1/4 |
| WS-22 | 1-3/8 |
| WS-24* | 1-1/2 |
| WS-26 | 1-5/8 |
| WS-28 | 1-3/4 |
| WS-30 | 1-7/8 |
| WS-32* | 2 |
| WS-34 | 2-1/8 |
| WS-36 | 2-1/4 |
| WS-38 | 2-3/8 |
| WS-40* | 2-1/2 |
| WS-42 | 2-5/8 |
| WS-46 | 2-7/8 |
| WS-48* | 3 |

Part numbers with a * at the end are also available for **Pipe**. When ordering add **-P** to the part number.

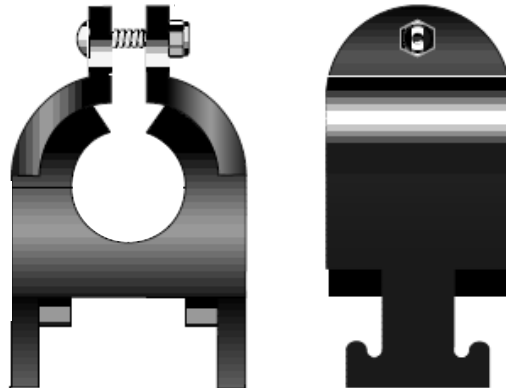

**Walker-Strut Clamps sold in bag quantities.
5 pieces per bag.**

UniStrut

For Hydro-Craft items not listed in this catalog speak with a customer service representative at **586.415.0455**.

Call Customer Service at **586-415-0455** to get information about the UniStrut products.



Hydraulic Tubing

Hydraulic tubing is sold in **20 Ft. lengths** and available in the following: Welded, Seamless, Stainless Steel, Wrot Copper, Zinc Dichromate, and Metric Sizes.

| Hydraulic Tubing | | | | |
|-----------------------|---------------|----------------------|----------------|---------------------|
| Outside Diameter (OD) | Dec. Wall-In. | Inside Diameter (ID) | Weight Lbs./Ft | Est. Burst Pressure |
| 1/8 | .028 | .069 | .0290 | 20,160 |
| | .030 | .065 | .3040 | 21,600 |
| 3/16 | .028 | .131 | .0478 | 13,404 |
| | .035 | .118 | .0572 | 16,755 |
| | .049 | .089 | .0727 | 23,457 |
| 1/4 | .028 | .194 | .0664 | 10,080 |
| | .035 | .180 | .0804 | 12,600 |
| | .049 | .152 | .1052 | 17,640 |
| | .065 | .120 | .1284 | 23,400 |
| 5/16 | .035 | .243 | .1039 | 10,096 |
| | .049 | .215 | .1382 | 14,135 |
| | .065 | .183 | .1722 | 18,750 |
| | .083 | .146 | .2039 | 23,942 |
| 3/8 | .028 | .319 | .1038 | 6,720 |
| | .035 | .305 | .1271 | 8,400 |
| | .049 | .277 | .1706 | 11,760 |
| | .058 | .259 | .1964 | 13,920 |
| | .065 | .245 | .2152 | 15,600 |
| 1/2 | .035 | .430 | .1738 | 6,300 |
| | .049 | .402 | .2360 | 8,820 |
| | .065 | .370 | .3020 | 11,700 |
| | .083 | .334 | .3696 | 14,940 |
| | .095 | .310 | .4109 | 17,100 |
| 5/8 | .035 | .555 | .2205 | 5,040 |
| | .049 | .527 | .3014 | 7,056 |
| | .065 | .495 | .3888 | 9,360 |
| | .083 | .459 | .4805 | 11,952 |
| | .095 | .435 | .5377 | 13,680 |

Buy Online at www.ServiceManufacturing.com
Customer Service 586.415.0455



Hydraulic Tubing

| Hydraulic Tubing | | | | |
|------------------------------|----------------------|-----------------------------|-----------------------|----------------------------|
| Outside Diameter (OD) | Dec. Wall-In. | Inside Diameter (ID) | Weight Lbs./Ft | Est. Burst Pressure |
| 3/4 | .035 | .680 | .2673 | 4,200 |
| | .049 | .652 | .3668 | 5,880 |
| | .065 | .620 | .4755 | 7,800 |
| | .072 | .606 | .5214 | 8,640 |
| | .083 | .584 | .5913 | 9,960 |
| | .095 | .560 | .6646 | 11,400 |
| | .109 | .532 | .7462 | 13,080 |
| | .120 | .510 | .8074 | 14,400 |
| 7/8 | .035 | .805 | .3140 | 3,600 |
| | .049 | .777 | .4323 | 5,040 |
| | .065 | .745 | .5623 | 6,686 |
| | .083 | .709 | .7021 | 8,537 |
| | .095 | .685 | .7914 | 9,771 |
| | .109 | .657 | .8917 | 11,211 |
| | .120 | .635 | .9676 | 12,343 |
| 1 | .035 | .930 | .3607 | 3,150 |
| | .049 | .902 | .4977 | 4,410 |
| | .065 | .870 | .6491 | 5,850 |
| | .083 | .834 | .8129 | 7,470 |
| | .095 | .810 | .9182 | 8,550 |
| | .109 | .782 | 1.0370 | 9,810 |
| | .120 | .760 | 1.1280 | 10,800 |
| 1-1/8 | .065 | .995 | .7359 | 5,200 |
| | .120 | .885 | 1.2880 | 9,600 |
| 1-1/4 | .049 | 1.152 | .6290 | 3,528 |
| | .065 | 1.120 | .8230 | 4,680 |
| | .083 | 1.084 | 1.034 | 5,976 |
| | .095 | 1.060 | 1.172 | 6,840 |
| | .109 | 1.032 | 1.328 | 7,848 |
| | .120 | 1.010 | 1.448 | 8,640 |



Hydraulic Tubing

| Hydraulic Tubing | | | | |
|-----------------------|---------------|----------------------|----------------|---------------------|
| Outside Diameter (OD) | Dec. Wall-In. | Inside Diameter (ID) | Weight Lbs./Ft | Est. Burst Pressure |
| 1-1/2 | .065 | 1.370 | .996 | 3,900 |
| | .083 | 1.334 | 1.256 | 4,980 |
| | .095 | 1.310 | 1.426 | 5,700 |
| | .109 | 1.282 | 1.619 | 6,540 |
| | .120 | 1.260 | 1.769 | 7,200 |
| | .134 | 1.232 | 1.955 | 8,040 |
| 2 | .065 | 1.870 | 1.343 | 2,925 |
| | .095 | 1.810 | 1.933 | 4,275 |
| | .120 | 1.760 | 2.409 | 5,400 |
| | .134 | 1.732 | 2.760 | 6,030 |



Bundy Tubing

Bundy tubing is sold in 20 Ft. lengths.

| Outside Diameter (OD) | Wall Thickness-In. |
|-----------------------|--------------------|
| 3/16 | .028 |
| 1/4 | .028 |
| 3/8 | .028 |



Buy Online at www.ServiceManufacturing.com
 Customer Service 586.415.0455



Pneumatic Tubing

Nylon and Polyethylene Tubing listed is Nycoil. Other brands are also available.

| NYLON TUBING | | | | | | | | | | | | |
|--------------|-----------|----------------|-------------|-------|-------|------------------|-------------|------------------|-----------|----------------|-------------|--|
| Tube O.D. | Tube I.D. | Wall Thickness | Part Number | | | Min. Bend Radius | Weight | Working Pressure | | Burst Pressure | Color Code | |
| | | | 100' | 500' | 1000' | | | PSI@68°F | PSI@125°F | | | |
| Inch | Inch | Inch | Reel | Reel | Reel | inch | 1000' (lbs) | | | | Suffix Key | |
| 1/8 | .080 | .023 | 6121_ | 6521_ | 6021_ | 1/4 | 3.3 | 500 | 350 | 1500 | | |
| 1/8 | .093 | .016 | 6122_ | 6522_ | 6022_ | 1/2 | 2.5 | 267 | 187 | 800 | 0 = NATURAL | |
| 5/32 | .106 | .025 | 6123_ | 6523_ | 6023_ | 5/8 | 4.8 | 333 | 233 | 1000 | 1 = BLACK | |
| 3/16 | .137 | .025 | 6133_ | 6533_ | 6033_ | 3/4 | 5.8 | 267 | 187 | 800 | 2 = RED | |
| 1/4 | .180 | .035 | 6144_ | 6544_ | 6044_ | 7/8 | 10.9 | 333 | 233 | 1000 | 3 = BLUE | |
| 1/4 | .125 | .062 | 6146_ | 6546_ | 6046_ | 1-1/4 | 16.9 | 667 | 467 | 2000 | 4 = GREEN | |
| 1/4 | .170 | .040 | 6147_ | 6547_ | 6047_ | 7/8 | 12.2 | 400 | 280 | 1200 | 5 = YELLOW | |
| 5/16 | .232 | .040 | 6155_ | 6555_ | 6055_ | 1 | 15.7 | 333 | 233 | 1000 | 6 = ORANGE | |
| 3/8 | .275 | .050 | 6166_ | 6566_ | 6066_ | 1-1/4 | 23.3 | 333 | 233 | 1000 | 7 = GRAY | |
| 1/2 | .375 | .062 | 6188_ | 6888_ | 6088_ | 2-1/4 | 39 | 267 | 187 | 800 | | |

| Polyethylene Fractional Inch Tubing | | | | | | | | | | | | |
|-------------------------------------|-----------|----------------|-------------|--------|-------|------------------|-------------|------------------|-----------|----------------|-------------|--|
| Tube O.D. | Tube I.D. | Wall Thickness | Part Number | | | Min. Bend Radius | Weight | Working Pressure | | Burst Pressure | Color Code | |
| | | | 100' | 500' | 1000' | | | PSI@68°F | PSI@125°F | | | |
| Inch | Inch | Inch | Reel | Reel | Reel | inch | 1000' (lbs) | | | | Suffix key | |
| 1/4 | 0.170 | 0.040 | 6244_ | 6444_ | 6644_ | 3/4 | 10.9 | 167 | 107 | 500 | 0 = Natural | |
| 5/16 | 0.190 | 0.062 | 6255_ | 6455_ | 6655_ | 5/8 | 20.2 | 200 | 128 | 600 | 1 = Black | |
| 3/8 | 0.250 | 0.062 | 6266_ | 6466_ | 6666_ | 1-1/8 | 25.3 | 167 | 107 | 500 | 2 = Red | |
| 1/2 | 0.375 | 0.062 | 6288_ | 6988_* | 6688_ | 2-1/8 | 35.5 | 133 | 85 | 400 | 3 = Blue | |
| | | | | | | | | | | | 4 = Green | |
| Polyethylene Metric Tubing | | | | | | | | | | | | |
| 4 MM | 2.5 MM | 0.75 MM | 7203_ | 7503_ | 7803_ | 12 MM | 5.0 | 200 | 125 | 600 | 5 = Yellow | |
| 6 MM | 4 MM | 1.00 MM | 7206_ | 7506_ | 7806_ | 36 MM | 10.2 | 167 | 110 | 500 | 6 = Orange | |
| 8 MM | 6 MM | 1.00 MM | 7208_ | 7508_ | 7808_ | 48 MM | 14.2 | 117 | 70 | 350 | 7 = Gray | |
| 10 MM | 8 MM | 1.00 MM | 7211_ | 7511_ | 7811_ | 60 MM | 18.3 | 83 | 50 | 250 | | |
| 12 MM | 9 MM | 1.50 MM | 7213_ | 7513_ | 7813_ | 70 MM | 31.5 | 117 | 70 | 350 | | |

| Armor-Weld Spatter Resistant Fractional Size Tubing | | | | | | | | |
|---|-----------------|-----------------|----------------------|-------------|------------------|--------------------|----------------|-----------------------|
| Part Number | Inner Tube O.D. | Inner Tube I.D. | Out Jacket Thickness | Bend Radius | W.P.@ 70°F (PSI) | 3:1 Burst Pressure | Package Length | Package Weight (Lbs.) |
| LE532B_ | .156 IN | .094 IN | .039 IN | .40 IN | 200 | 600 | 250' | 6.1 |
| LE14B_ | .250 IN | .156 IN | .039 IN | .59 IN | 180 | 540 | 250' | 8.65 |
| LE516B_ | .312 IN | .187 IN | .039 IN | .79 IN | 175 | 525 | 250' | 11.59 |
| LE38B_ | .375 IN | .250 IN | .039 IN | .98 IN | 150 | 450 | 250' | 15 |
| LE12B_ | .500 IN | .328 IN | .039 IN | 1.17 IN | 150 | 450 | 250' | 23.2 |
| Armor-Weld Spatter Resistant Metric Size Tubing | | | | | | | | |
| LE04MF_ | 4 MM | 2.5 MM | 1 MM | 10 MM | 200 | 600 | 100 M | 8 |
| LE06MF_ | 6 MM | 4 MM | 1 MM | 15 MM | 180 | 540 | 100 M | 10 |
| LE08MF_ | 8 MM | 5 MM | 1 MM | 20 MM | 175 | 525 | 100 M | 15.2 |
| LE10MF_ | 10 MM | 6.5 MM | 1 MM | 25 MM | 150 | 450 | 100 M | 21.6 |
| LE12MF_ | 12 MM | 8 MM | 1 MM | 30 MM | 150 | 450 | 100 M | 28 |

| Spatter Resistant Stock Color Chart: • = Stock, X = Non Stock | | | | | | | |
|---|-----------|----------|----------------|--------|-----------|----------|---|
| LE | BK= Black | G= Green | LB= Light Blue | R= Red | Y= Yellow | W= White | |
| 4MM/5/32 | • | X | • | X | • | • | X |
| 1/4 | • | X | • | • | X | • | X |
| 5MM/5/16 | • | • | • | • | • | • | • |
| 3/8 | • | X | • | • | X | • | X |
| 1/2 | • | • | • | X | X | • | • |
| 6MM | • | • | • | • | • | • | • |
| 10MM | • | • | • | • | • | • | • |
| 12MM | • | • | • | • | • | • | • |



Black & Galvanized Pipe

Pipe comes in **21 Ft. lengths** and is available plain end (PE) or threaded with couplings. Also available in PVC.



| Black & Galvanized Pipe | | |
|-------------------------|-----------------------------|-----------------------------|
| Nominal Pipe Size | Sch 40 Wall Thickness (In.) | Sch 80 Wall Thickness (In.) |
| 1/8 | .068 | .095 |
| 1/4 | .088 | .119 |
| 3/8 | .091 | .126 |
| 1/2 | .109 | .147 |
| 3/4 | .113 | .154 |
| 1 | .133 | .179 |
| 1-1/4 | .140 | .191 |
| 1-1/2 | .145 | .200 |
| 2 | .154 | .218 |
| 2-1/2 | .203 | .276 |
| 3 | .216 | .300 |
| 3-1/2 | .226 | .318 |
| 4 | .237 | .337 |
| 5 | .258 | .375 |



*U-Bolts for pipe can be found on Pg. 42.

Buy Online at www.ServiceManufacturing.com
Customer Service 586.415.0455



Malleable Pipe Fittings & Nipples

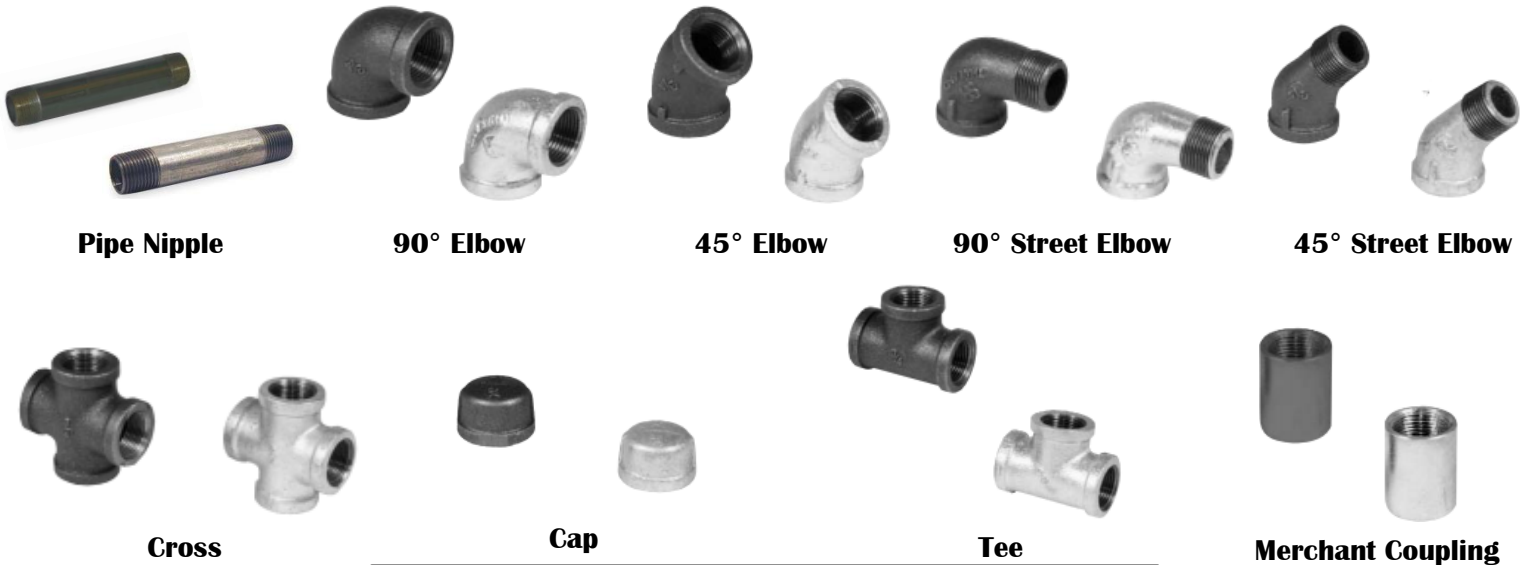

Fittings available in standard pipe thread, BSPP, & BSPT

| Description | Black Part No. | Galvanized Part No. |
|-------------------|--------------------------|---------------------------|
| Sch 40 Nipple | Size x Size - BSN | Size x Size - GSN |
| Sch 80 Nipple | Size x Size - EHN | N/A |
| 90° Elbow | Size - MAL - 90 | Size - GALV - 90 |
| 45° Elbow | Size - MAL - 45 | Size - GALV - 45 |
| 90° Street Elbow | Size - STREET - 90 | Size - GALV - STREET - 90 |
| 45° Street Elbow | Size - STREET - 45 | Size - GALV - STREET - 45 |
| Cross | Size - MAL - CROSS | Size - GALV - CROSS |
| Cap | Size - MAL - CAP | Size - GALV - CAP |
| Tee | Size - MAL - TEE | Size - GALV - TEE |
| Merchant Coupling | Size - MAL - COUPLING | Size - GALV - COUPLING |
| Bell Reducer | Size x Size - MAL - BELL | Size x Size - GALV - BELL |
| Union | Size - MAL - UNION | Size - GALV - UNION |
| Reducer Bushing | Size x Size - MAL - RED | Size x Size - GALV - RED |
| Square Head Plug | Size - MAL - PLUG | Size - GALV - PLUG |

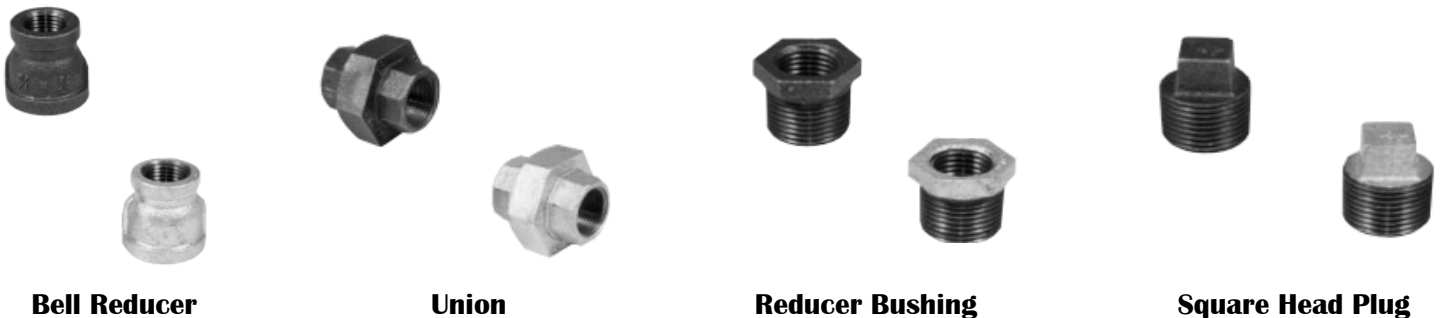

CONTINENTAL Push-On Hose

Other Push-On hose is available upon request.

| Continental FLEXAGrip | | | |
|-----------------------|-------|-------|-----|
| PART # | Color | Sizes | PSI |
| 9272 - Size | Black | 3/16 | 400 |
| 9273 - Size | Blue | 1/4 | 400 |
| 9274 - Size | Gray | 3/8 | 400 |
| 9275 - Size | Green | 1/2 | 400 |
| 9276 - Size | Red | 5/8 | 400 |
| 9277 - Size | Brown | 3/4 | 400 |
| 9248 - Size | White | 1 | 300 |



ContiTech

CONTINENTAL FLEXAGrip can be used with any of the fittings found on pages 1-4.

CONTINENTAL Hydraulic Hose

| Part Number | Hose I.D. | Max. Working Pressure P.S.I. | Min. Burst Pressure P.S.I. | Min. Bend Radius |
|--|-----------|------------------------------|----------------------------|------------------|
| Medium Pressure CONTINENTAL 1 Wire Braid Hose | | | | |
| 1/4-100R1 | 1/4 | 3270 | 13080 | 4" |
| 3/8-100R1 | 3/8 | 2615 | 10460 | 5" |
| 1/2-100R1 | 1/2 | 2320 | 9280 | 7" |
| 3/4-100R1 | 3/4 | 1530 | 6120 | 9-1/2" |
| 1-100R1 | 1 | 1280 | 5120 | 12" |
| 1-1/4-100R1 | 1-1/4 | 920 | 3680 | 16-1/2" |
| High Pressure CONTINENTAL 2 Wire Braid Hose | | | | |
| 1/4-100R2 | 1/4 | 5800 | 23200 | 4" |
| 3/8-100R2 | 3/8 | 4800 | 19200 | 5" |
| 1/2-100R2 | 1/2 | 4000 | 16000 | 7" |
| 3/4-100R2 | 3/4 | 3120 | 12480 | 9-1/2" |
| 1-100R2 | 1 | 2400 | 9600 | 12" |
| 1-1/4-100R2 | 1-1/4 | 1820 | 7280 | 16-1/2" |

100R1



100R2



| CONTINENTAL Crimp-On Hose | |
|---------------------------|--------------------------------|
| PART NO. Ends | DESCRIPTION |
| 93136 - Size - Size | Female JIC Swivel Hose End |
| 93138 - Size - Size | Female JIC Swivel Hose End 90° |
| 93110 - Size - Size | Male Pipe Hose End |
| 93111 - Size - Size | Male Pipe Swivel Hose End |

*Hose assemblies made to order.

For other types of **Continental** hose contact a customer service representative at **586.415.0455**.

Buy Online at www.ServiceManufacturing.com
Customer Service **586.415.0455**



Breather Vent

| Part Number | Description |
|-------------|-------------------------|
| F-18 | 1/8 Brass Breather Vent |
| F-28 | 1/4 Brass Breather Vent |
| F-38 | 3/8 Brass Breather Vent |
| F-48 | 1/2 Brass Breather Vent |
| F-68 | 3/4 Brass Breather Vent |

*For Nickel-Plated Iron use BVS-Size



F-Size



BVS-Size

Pneumatic Exhaust Muffler

| Part Number | Description |
|-------------|---------------------------|
| P-18 | 1/8 EXHAUST MUFFLER BRASS |
| P-28 | 1/4 EXHAUST MUFFLER BRASS |
| P-38 | 3/8 EXHAUST MUFFLER BRASS |
| P-48 | 1/2 EXHAUST MUFFLER BRASS |
| P-68 | 3/4 EXHAUST MUFFLER BRASS |



Pneumatic Exhaust Muffler Nickel Plated

| Part Number | Description |
|-------------|--|
| BMS-18 | 1/8 EXHAUST MUFFLER NICKEL PLATED IRON |
| BMS-28 | 1/4 EXHAUST MUFFLER NICKEL PLATED IRON |
| BMS-38 | 3/8 EXHAUST MUFFLER NICKEL PLATED IRON |
| BMS-48 | 1/2 EXHAUST MUFFLER NICKEL PLATED IRON |
| BMS-68 | 3/4 EXHAUST MUFFLER NICKEL PLATED IRON |



Grease Fittings

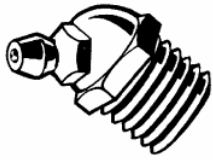

| Part No. | Size | Degree |
|----------|----------------------------------|----------|
| 5000 | 1/8 Male Pipe Thread | Straight |
| 5003 | 1/8 Male Pipe Thread 1-1/14 Long | Straight |
| 5100 | 1/8 Male Pipe Thread | 38° |
| 5200 | 1/8 Male Pipe Thread | 45° |
| 5300 | 1/8 Male Pipe Thread | 67° |
| 5400 | 1/8 Male Pipe Thread | 90° |
| 5010 | 1/4-28 Thread- 17/32 Long | Straight |
| 5014 | 1/4-28 Thread- 15/16 Long | Straight |
| 5210 | 1/4-28 Thread | 45° |
| 5410 | 1/4-28 Thread | 90° |
| 5050 | 1/4 Male Pipe Thread | Straight |
| 5350 | 1/4 Male Pipe Thread | 67.5° |
| 5033 | 3/16 Drive Type | Straight |
| 5029 | 1/4 Drive Type | Straight |
| 5030 | 5/16 Drive Type | Straight |
| 5061 | 5/16-24 Thread | Straight |
| 5062 | 3/8-24 Thread | Straight |

Tube T-Clips



| PART# | TUBE SIZE | DESCRIPTION |
|----------|-----------|-------------|
| PCT-4-2 | 5/32 | TUBE T-CLIP |
| PCT-6-2 | 1/4 | TUBE T-CLIP |
| PCT-8-2 | 5/16 | TUBE T-CLIP |
| PCT-10-2 | 3/8 | TUBE T-CLIP |
| PCT-12-2 | 1/2 | TUBE T-CLIP |
| PCT-15-2 | 5/8 | TUBE T-CLIP |
| PCT-18-2 | 3/4 | TUBE T-CLIP |

Buy Online at www.ServiceManufacturing.com
 Customer Service 586.415.0455



Standard Tube Clips

| TUBE CLIP SIZES | | | | | | | |
|-----------------|----------|---------|---------|----------|---------|---------|---------|
| 1/8 | 3/16 | 1/4 | 3/8 | 5/16 | 1/2 | 5/8 | 3/4 |
| 1/8 x 1 | 3/16 x 1 | 1/4 x 1 | 3/8 x 1 | 5/16 x 1 | 1/2 x 1 | 5/8 x 1 | 3/4 x 1 |
| 1/8 x 2 | 3/16 x 2 | 1/4 x 2 | 3/8 x 2 | 5/16 x 2 | 1/2 x 2 | 5/8 x 2 | 3/4 x 2 |
| 1/8 x 3 | 3/16 x 3 | 1/4 x 3 | 3/8 x 3 | 5/16 x 3 | 1/2 x 3 | 5/8 x 3 | 3/4 x 3 |
| 1/8 x 4 | 3/16 x 4 | 1/4 x 4 | 3/8 x 4 | 5/16 x 4 | 1/2 x 4 | 5/8 x 4 | 3/4 x 4 |
| 1/8 x 5 | 3/16 x 5 | 1/4 x 5 | 3/8 x 5 | 5/16 x 5 | 1/2 x 5 | 5/8 x 5 | |
| 1/8 x 6 | 3/16 x 6 | 1/4 x 6 | 3/8 x 6 | | 1/2 x 6 | 5/8 x 6 | |
| 1/8 x 7 | 3/16 x 7 | 1/4 x 7 | 3/8 x 7 | | 1/2 x 7 | 5/8 x 7 | |
| 1/8 x 8 | 3/16 x 8 | 1/4 x 8 | 3/8 x 8 | | 1/2 x 8 | 5/8 x 8 | |



Don't forget to order self-tapping screws with tube clips!

Hydraulic Tube Clips are Manufactured from **16 gauge material** they have **9/32" Holes** with **3/4" Wings** with the **exception of 1/8" tube clips**, which have **7/32" holes**



Metric Tube Clips

| Metric Tube Clip Sizes | | | | | |
|------------------------|---------|---------|----------|----------|----------|
| 4MM | 6MM | 8MM | 10MM | 12MM | 16MM |
| 4MM X 1 | 6MM X 1 | 8MM X 1 | 10MM X 1 | 12MM X 1 | 16MM X 1 |
| 4MM X 2 | 6MM X 2 | 8MM X 2 | 10MM X 2 | 12MM X 2 | |
| 4MM X 3 | 6MM X 3 | 8MM X 3 | 10MM X 3 | | |
| 4MM X 4 | 6MM X 4 | 8MM X 4 | 10MM X 4 | | |
| 4MM X 5 | 6MM X 5 | 8MM X 5 | 10MM X 5 | | |
| 4MM X 6 | | | | | |



Buy Online at www.ServiceManufacturing.com

Customer Service 586.415.0455

Oetiker Clamp



| Part Number | Size In. | Size Ref. MM | Description |
|-------------|----------|--------------|------------------|
| 1315 | 9/16 | 15 | Double Ear Clamp |
| 1517 | 19/32 | 17 | Double Ear Clamp |
| 1518 | 5/8 | 18 | Double Ear Clamp |
| 1720 | 3/4 | 20 | Double Ear Clamp |
| 1922 | 13/16 | 22 | Double Ear Clamp |
| 2023 | 7/8 | 23 | Double Ear Clamp |
| 2225 | 15/16 | 25 | Double Ear Clamp |
| 2327 | 1 | 27 | Double Ear Clamp |
| 2731 | 1-1/16 | 31 | Double Ear Clamp |
| 3134 | 1-5/16 | 34 | Double Ear Clamp |
| 3437 | 1-7/16 | 37 | Double Ear Clamp |
| 3740 | 1-1/2 | 40 | Double Ear Clamp |

Oetiker Pincher Tool



| Part Number | Description |
|-------------|------------------------------|
| 1098 | STANDARD OETIKER JAW PINCERS |
| 1099 | OETIKER SIDE JAW PINCERS |

Hose Cutting Tool

| Part Number | Description |
|-------------------|--|
| MULTI-CUTTER | HOSE CUTTING TOOL |
| REPLACEMENT BLADE | REPLACEMENT BLADES FOR MULTI-CUTTER TOOL |



Buy Online at www.ServiceManufacturing.com
 Customer Service 586.415.0455



U-Bolts

| |
|--------------------------|
| Part Number |
| 1/4-U-BOLT |
| 3/8-U-BOLT |
| 1/2-U-BOLT |
| 1/2-U-BOLT-LONG |
| 3/4-U-BOLT |
| 1-U-BOLT |
| 1-1/4-U-BOLT |
| 1-1/4-U-BOLT-LONG |
| 1-1/2-U-BOLT |
| 1-1/2-U-BOLT-LONG |
| 2-U-BOLT |
| 2-1/2-U-BOLT |
| 2-1/2-U-BOLT-LONG |
| 3-U-BOLT |
| 4-U-BOLT |



Gauges, Quick Disconnects, Valves & Tools

Service Manufacturing offers a wide range of gauges, quick disconnects, valves, and hand tools. Call **Customer Service** for information about these products.



Buy Online at www.ServiceManufacturing.com
Customer Service 586.415.0455

Miscellaneous Accessories

Teflon Tape



| Part Number |
|-----------------|
| 1/4-Teflon-Tape |
| 1/2-Teflon-Tape |
| 3/4-Teflon-Tape |
| 1-Teflon-Tape |

Jomar Thread Sealant



| Part Number | Description | Size |
|------------------|-----------------------|----------|
| Green Stuff-Pint | Gimme The Green Stuff | 16oz Can |
| White Stuff-Pint | Gimme The White Stuff | 16oz Can |

Laco-Loc Anaerobic Pipe Thread Sealant



| Part Number | Size |
|-------------|-------------|
| LG-LACO-LOC | 8.45oz Tube |
| SM-LACO-LOC | 1.69oz Tube |

Buy Online at www.ServiceManufacturing.com
 Customer Service 586.415.0455



Product Index

| Part Number | Page | Part Number | Page | Part Number | Page |
|--------------------|-------------|--------------------|-------------|--------------------|-------------|
| 306 | 14, 16 | 806 (2408) | 14, 16 | 921 (5602) | 14, 17 |
| 318 | 14, 16 | 815 (2403) | 14, 16 | 922 (5604) | 14, 17 |
| 319 | 14, 16 | 816 (2404) | 14, 16 | 923 (5603) | 14, 17 |
| 500 (6402) | 14, 18 | 818 (318) | 14, 16 | 924 (306) | 14, 16 |
| 506 (6408) | 14, 18 | 819 (319) | 14, 16 | 932 (SPPCH) | 14, 17 |
| 506S (6409) | 14, 18 | 820 (304-C) | 14, 16 | 0107 (1404) | 14, 17 |
| 507 (6405) | 14, 18 | 821 (2500) | 14, 16 | 0207 (1405) | 14, 17 |
| 508 (6410) | 14, 18 | 822 (2501) | 14, 16 | 0507 (6900) | 14, 18 |
| 509 (6404) | 14, 18 | 823 (2503) | 14, 16 | 1404 | 14, 17 |
| 516 (6400) | 14, 18 | 824 (2603) | 14, 16 | 1405 | 14, 17 |
| 522 (6801) | 14, 18 | 825 (2601) | 14, 16 | 1501 | 14, 17 |
| 525 (6803) | 14, 18 | 826 (2605) | 14, 16 | 1502 | 14, 17 |
| 526 (6804) | 14, 18 | 827 (2650) | 14, 16 | 1503 | 14, 17 |
| 527 (6806) | 14, 18 | 831 (2705) | 14, 16 | 1504 | 14 |
| 528 (6805) | 14, 18 | 832 (2700) | 14, 16 | 1601 | 14, 17 |
| 601 (1501) | 14, 17 | 833 (2701) | 14, 16 | 1602 | 14 |
| 602 (1502) | 14, 17 | 834 (2703) | 14 | 1603 | 14 |
| 603 (1603) | 14 | 835 (2704) | 14 | 2107 (1501) | 14, 17 |
| 604 (1404) | 14, 17 | 837 (2702) | 14, 16 | 2207 (1502) | 14, 17 |
| 605 (1405) | 14, 17 | 854 (2405) | 14, 16 | 2403 | 14, 16 |
| 606 (1503) | 14, 17 | 855 (2502) | 14, 16 | 2404 | 14, 16 |
| 607 (1504) | 14 | 856 (2602) | 14, 16 | 2405 | 14, 16 |
| 608 (1601) | 14, 17 | 857 (2606) | 14, 16 | 2406 | 14, 16 |
| 609 (1602) | 14 | 860 (2406) | 14, 16 | 2408 | 14, 16 |
| 612 (6902) | 14, 18 | 877 (2501L) | 14, 16 | 2500 | 14, 16 |
| 617 (6401) | 14, 18 | 878 (2501LL) | 14, 16 | 2501 | 14, 16 |
| 618 (6505) | 14, 16 | 909 (5405) | 14, 17 | 2502 | 14, 16 |
| 619 (6900) | 14, 18 | 910 (5000) | 14, 17 | 2503 | 14, 16 |
| 620 (6809) | 14, 18 | 911 (5404) | 14, 17 | 2507 (6901) | 14, 18 |
| 620P (6901) | 14, 18 | 912 (5406) | 14, 17 | 2601 | 14, 16 |
| 621 (6506) | 14, 16 | 914 (5502) | 14, 17 | 2602 | 14, 16 |
| 622 (6500) | 14, 16 | 915 (5503) | 14, 17 | 2603 | 14, 16 |
| 623 (6502) | 14, 16 | 916 (5504) | 14, 17 | 2605 | 14, 16 |
| 625 (6600) | 14, 16 | 917 (5605) | 14, 17 | 2606 | 14, 16 |
| 626 (6602) | 14, 16 | 918 (5652) | 14, 17 | 2650 | 14, 16 |
| 627 (6501) | 14, 16 | 920 (5500) | 14, 17 | 2700 | 14, 16 |



Buy Online at www.ServiceManufacturing.com

Customer Service **586.415.0455**

Service Manufacturing & Supply Co.

| Part Number | Page | Part Number | Page | Part Number | Page |
|--------------|--------|----------------------|--------|-------------------|--------|
| 2701 | 14, 16 | 6500 | 14, 16 | 1203P/2203P (BPT) | 10 |
| 2702 | 14, 16 | 6501 | 14, 16 | 122HBL (HS) | 3 |
| 2703 | 14 | 6502 | 14, 16 | 125HBL (1XX) | 2 |
| 2704 | 14 | 6504 | 14, 16 | 129HB (9XX) | 2 |
| 2705 | 14, 16 | 6505 | 14, 16 | 139HB (4XX) | 2 |
| 2706 | 14, 16 | 6506 | 14, 16 | 145SBB (4XX) | 2 |
| 3107 (1503) | 14, 17 | 6600 | 14, 16 | 170C (70F) | 11 |
| 3152 (BPPHH) | 10 | 6602 | 14, 16 | 171C (71F) | 11 |
| 3200 (PA) | 9 | 6801 | 14, 18 | 180B (1XX) | 2 |
| 3220 (BRB) | 10 | 6802 | 14, 18 | 190SBB (9XX) | 2 |
| 3300 (BPC) | 10 | 6803 | 14, 18 | 1XX | 2 |
| 3325 (BHN) | 10 | 6804 | 14, 18 | 207ACBH | 10 |
| 3507 (6902) | 14, 18 | 6805 | 14, 18 | 207P/208P (BPC) | 10 |
| 3950 (BPCR) | 10 | 6806 | 14, 18 | 209P (BRB) | 10 |
| 5000 | 14, 17 | 6807 | 14, 18 | 211P (BPPSQ) | 10 |
| 5404 | 14, 17 | 6808 | 14, 18 | 212P (BPU) | 10 |
| 5405 | 14, 17 | 6809 | 14, 18 | 215PN (BN) | 11 |
| 5406 | 14, 17 | 6900 | 14, 18 | 218P (BPPHH) | 10 |
| 5500 | 14, 17 | 6901 | 14, 18 | 219P (BPPCH) | 10 |
| 5501 | 14 | 6902 | 14, 18 | 2205P (BPCR) | 10 |
| 5502 | 14, 17 | 30182 (POM) | 1 | 220P (BPPSL) | 10 |
| 5503 | 14, 17 | 30382 (POT) | 1 | 2214P (4XX-PE) | 8 |
| 5504 | 14, 17 | 30682 (PO) | 1 | 2224P (MBPT) | 10 |
| 5505 | 14, 17 | 93110 | 37 | 2225P (BPST) | 10 |
| 5602 | 14, 17 | 93111 | 37 | 222P (PA) | 9 |
| 5603 | 14, 17 | 93136 | 37 | 2403LH | 14, 16 |
| 5604 | 14, 17 | 93138 | 37 | 2405B | 6 |
| 5605 | 14, 17 | 100R1 | 37 | 2501L | 14, 16 |
| 5652 | 14, 17 | 100R2 | 37 | 2501LL | 14, 16 |
| 6400 | 14, 18 | 105B (POM) | 1 | 265C (65F) | 11 |
| 6401 | 14, 18 | 106B (POT) | 1 | 269C (69F) | 11 |
| 6402 | 14, 18 | 115SB (HS) | 3 | 304-C | 14, 16 |
| 6404 | 14, 18 | 119B (PO) | 1 | 3500 (BPE) | 10 |
| 6405 | 14, 18 | 119SBB (NSBA) | 3 | 3600 (MBPT) | 10 |
| 6408 | 14, 18 | 1200P/2200P (BPE) | 10 | 3700 (BPT) | 10 |
| 6410 | 14, 18 | 1202P/2202P (9XX-PE) | 8 | 3750 (BPST) | 10 |
| | | | | 4XX | 2 |

Buy Online at www.ServiceManufacturing.com

Customer Service **586.415.0455**



Service Manufacturing & Supply Co.

| Part Number | Page | Part Number | Page | Part Number | Page |
|----------------|--------|----------------------------|--------|------------------------------|----------|
| 4XX-PE | 8 | 70F | 11 | 9XXPEL-S | 12 |
| 4XX-PE-S | 12 | 71F | 11 | 9XXPE-S | 12 |
| 506S (6409) | 14, 18 | 72F | 11 | 9XX-PES-S | 12 |
| 516-L (6400L) | 14 | 815CB (62F) | 11 | AEOG (6805) | 14, 18 |
| 522L (6801L) | 14, 18 | 815LH (2403LH) | 14, 16 | AOEX6 (6809) | 14, 18 |
| 522LL (6801LL) | 14, 18 | 816CB (68F) | 11 | B- | 27 |
| 5406P | 14, 17 | 818CB (61F) | 11 | BALL VALVE | 11 |
| 562XX | 19 | 819CB (60F) | 11 | BFCH | 10 |
| 564XX | 19 | 821CB (65F) | 11 | BHN | 10 |
| 565XX | 19 | 822CB (69F) | 11 | BMS- | 38 |
| 566XX | 19 | 826CB (71F) | 11 | BN | 11 |
| 569XX | 19 | 854CB (66F) | 11 | BPC | 10 |
| 571XX | 19 | 855CB (70F) | 11 | BPCR | 10 |
| 572XX | 19 | 909B (PA) | 9 | BPE | 10 |
| 579XX | 19 | 909DL (1XX-PAL-1-S) | 12 | BPPCH | 10 |
| 582XX | 19 | 909DSS (PAS) | 12 | BPPHH | 10 |
| 60C (60F) | 11 | 909DS (PAL-S) | | BPPSL | 10 |
| 60F | 11 | 910B (BPC) | 10 | BPPSQ | 10 |
| 618B (UTS-1) | 7 | 912B (BRB) | 10 | BPST | 10 |
| 61C (61F) | 11 | 914B (9XX-PE) | 8 | BPT | 10 |
| 61F | 11 | 914-4-28-2DS (92-428-PE-S) | 12 | BPU | 10 |
| 627B (UTS-9) | 7 | 914DL (9XX-PEL-S) | 12 | BRB | 10 |
| 62C (62F) | 11 | 914DS (9XX-PE-S) | 12 | BSAE- | 27 |
| 62F | 11 | 914-XXDSS (9XX-PES-S) | | BTX (318) | 14, 16 |
| 64F | 11 | 915B (4XX-PE) | 8 | Bundy Tubing | 33 |
| 6400L | 14 | 915DS (4XX-PE-S) | 12 | BVS- | 38 |
| 6407 /3474 | 14, 18 | 916B (BPE) | 10 | C50X (6801) | 14, 18 |
| 6409 | 14, 18 | 917B (BPT) | 10 | C6X (6500) | 14, 16 |
| 645B (UTS-4) | 7 | 918B (BPCR) | 10 | CC50X (6801L) | 14, 18 |
| 65F | 11 | 921B (BPST) | 10 | CCC50X (6801LL) | 14, 18 |
| 66C (66F) | 11 | 922B (MBPT) | 10 | CCCTX (2501LL) | 14, 16 |
| 66F | 11 | 92-428-PE-S | 12 | CCTX (2501L) | 14, 16 |
| 6801L | 14, 18 | 932B (BPPCH) | 10 | CD/1202P, 2202P(5502/9XX-PE) | 14, 17/8 |
| 6801LL | 14, 18 | 932BSH (BPPSQ) | 10 | CD45 (5503) | 14, 17 |
| 68C (68F) | 11 | 932PB (BPPHH) | 10 | CR (5500) | 14, 17 |
| 68F | 11 | 9XX | 2 | Crimp-On Fittings | 37 |
| 69F | 11 | 9XX-PE | 8 | CTX/CTX-B (2501/ETMB) | 14, 16/5 |



Buy Online at www.ServiceManufacturing.com

Customer Service **586.415.0455**

Service Manufacturing & Supply Co.

| Part Number | Page | Part Number | Page | Part Number | Page |
|----------------------------|-----------|-------------------------|----------------|--------------------------|-----------|
| DD/1200P/2200P (5504/ BPE) | 14, 17/10 | Hose | 37 | P50N (6408) | 14, 18 |
| DD45 (5505) | 14, 17 | Hose Cutter | 41 | P541XX | 20 |
| DTX/DTX-B (2502/2502B) | 14, 16 | HP/211P (5406P/BPPHH) | 14, 17/10 | P543XX | 20 |
| EBC (ETMB) | 5 | HP50N(6409) | 14, 18 | P562XX | 20 |
| ETM45B | 5 | HS | 3 | P564XX | 20 |
| ETMB | 5 | HTX (2403) | 14, 16 | P568XX | 19 |
| ETX (2500) | 14, 16 | HU (HS) | 3 | P571XX | 20 |
| F- | 38 | Hydraulic Hose | 37 | P572XX | 20 |
| F50F (6401) | 14, 18 | Hydraulic Tubing | 31, 32, 33 | P579XX | 20 |
| F50G (6405) | 14, 18 | Hydro-Craft | 27, 28, 29, 30 | PA | 9 |
| F50G5 (6410) | 14, 18 | Industrial Barb | 2, 3, 4 | PAL-1-S | 12 |
| F50HAO (6407) | 14, 18 | Jomar | 43 | PAL-S | 12 |
| F50X (6400) | 14, 18 | JS (UTS-1) | 7 | PAR | 9 |
| F60X (6505) | 14, 16 | JSE (UTS-9) | 7 | PAS | 12 |
| F65X (6402) | 14, 18 | JSF (UTS-4) | 7 | PCT- | 39 |
| FB (1XX) | 2 | JTX (2603) | 14, 16 | Pipe | 35 |
| FBC (ETM45B) | 5 | KMMOO/2205P (5652/BPCR) | 14, 17/10 | PLJ (POT) | 1 |
| FBE (9XX) | 2 | KTX (2650) | 14, 16 | PLM (POM) | 1 |
| FBF (4XX) | 2 | Laco-Loc | 43 | PLS (PO) | 1 |
| FF/216P (5404/BHN) | 14, 17/10 | LETMB | 5 | PNTX/PNTX-B (2408/2408B) | 14, 16 |
| FF50X (6400L) | 14 | LHTX (2403LH) | 14, 16 | PO | 1 |
| FG/222P (5405/PA) | 14, 17/9 | Lube Block | 21 | POF | 1 |
| FHG5 (6404) | 14, 18 | Malleable Fittings | 36 | POM | 1 |
| FJS (NSBA) | 3 | | 22,23,24,25, | POT | 1 |
| FMB (2405B) | 6 | Manifold | 26 | PTR/209P (5406/BRB) | 14, 17/10 |
| FNTX/213P (304-C/304-C-B) | 14, 16 | MBPT | 10 | Push-On Hose | 37 |
| FPSCH | 17 | MMO/2203P (5605/BPT) | 14, 17/10 | R50X (6804) | 14, 18 |
| FTX/FTX-B (2404/STMB) | 14, 16/6 | MMS/2224P (5604/MBPT) | 14, 17/10 | R6X (6602) | 14, 16 |
| G- | 28, 29 | MM-TC | 40 | RTX/RTX-B (2605/2605B) | 14, 16 |
| GG/207P,208P (5000/BPC) | 14, 17/10 | MRO/2225P (5602/BPST) | 14, 17/10 | S50X (6803) | 14, 18 |
| GoodYear | 37 | MTX/MTX-B (2606/2606B) | 14, 16 | S6X (6600) | 14, 16 |
| Grease Fittings | 39 | N- | 29 | SBC (STMB) | 6 |
| Green Stuff | 43 | NSBA | 3 | SJS | 13 |
| GTX/GTX-B (2405/2405B) | 14, 16/6 | Nylon Tubing | 34 | SM | 13 |
| HAS | 13 | Oetiker | 2, 4, 41 | SPPCH | 14, 17 |
| HC- | 27, 28 | OTX/OTX-B 2602/2602B) | 14, 16 | SPPSQ | 17 |
| HDC | 13 | P- | 38 | STMB | 6 |

Buy Online at www.ServiceManufacturing.com

Customer Service **586.415.0455**



Service Manufacturing & Supply Co.

| Part Number | Page | Part Number | Page |
|--------------------------|----------|-------------------|----------|
| STX/STX-B (2601/2601B) | 14, 16 | White Stuff | 43 |
| T- | 29 | WJTX (2704) | 14 |
| T-1XX | 3 | WJTX (2703) | 14 |
| TC | 40 | WLN (306) | 14, 16 |
| Teflon | 43 | WNTX (2702) | 14, 16 |
| TRTX/TRTX-B (2406/2406B) | 14, 16 | WS- | 30 |
| TX (319) | 14, 16 | WTX (2700) | 14, 16 |
| U1XX | 4 | X6EF (6501/UTS-9) | 14, 16/7 |
| U4XX | 4 | | |
| U9XX | 4 | | |
| U-Bolt | 35, 42 | | |
| UnionB (BPU) | 10 | | |
| UTS-1 | 7 | | |
| UTS-4 | 7 | | |
| UTS-9 | 7 | | |
| V6X (6502) | 14, 16 | | |
| VTX/VTX-B (2503/ETM45B) | 14, 16/5 | | |
| W- | 29 | | |
| WETX (2701) | 14, 16 | | |
| WFTX (2706) | 14, 16 | | |
| WGTX/WGTX-B (2705/2705B) | 14, 16 | | |

DISTRIBUTORS OF THE FOLLOWING PRODUCTS:

Anchor Flange
Bundy Tubing
Campbell
Fittings
Dixon Valve
Dropsa
Dot Els
Continental Hose

Hydro-Craft
Jomar Products
Lexair
Lube Devices
Markal (Laco-
Loc)
Nycoil
Oetiker

Olsen
SMC
SMS Brass
Fitting
SMS Steel
Fittings



Buy Online at www.ServiceManufacturing.com

Customer Service 586.415.0455

Don't forget to check out our new website at www.servicemanufacturing.com

We've updated our website to make the ordering process easier than ever. After you set up an account you can choose to have orders picked up in-store or shipped to you. You can also choose to pay in-store, by invoice (with and approved account), or by credit card. Please contact a customer service representative if you need any assistance with our new website.

SERVICE MANUFACTURING
& SUPPLY COMPANY

[Home](#) [Products](#) [Resources](#) [Deals of the Day](#) [Get In Touch](#)



FEATURED PRODUCTS



STMB
\$7.00 \$2.58 Sale



ETMB
\$7.00 \$3.27 Sale



ETM45B
\$7.00 \$4.29 Sale



2405-BRASS
\$7.00 \$5.34 Sale



STTB
\$7.00 \$3.54 Sale



UTS-1XX
\$7.00 \$3.52 Sale



UTS-4XX
\$7.00 \$6.68 Sale



UTS-9XX
\$7.00 \$4.34 Sale

Stay up to date be checking the Resources page for updated Charts, Catalogs, and Certificates.

Buy Online at www.ServiceManufacturing.com
Customer Service 586.415.0455



1.586.415.0455
Fax 1.586.415.0459



www.servicemanufacturing.com
sales@servicemanufacturing.com

Service Mfg. & Supply Co.
33380 Groesbeck Hwy
Fraser, MI 48026

