



# INSTALLATION INSTRUCTIONS: THE EXISTING FENCE CONVERSION SYSTEM

Scan to review our  
installation video:



## INCLUDED PARTS:

(12) Arm Mounting Plates

(12) Spring-Loaded Arms

(1) 4ft x 100ft Heavy Duty Poly Mesh Fence Roll

(12) Set Screws

(1) Bag (100) Zip Ties

(2) Arm to Wall Straps

(1) Hex Wrench (for set screws)

**Please note:** Fasteners to attach the mounting plates to your fence or wall are not included. The appropriate fasteners needed for different fence types are addressed within the instructions. In addition, the components listed above are for a 100ft kit. If you ordered more or less than 100ft, your components may vary.

### IMPORTANT:



It is strongly recommended that you review the installation video by scanning the QR code in the upper right or visiting our website before starting your installation for the best results!

## 1 SECURE THE MOUNTING PLATES TO YOUR FENCE

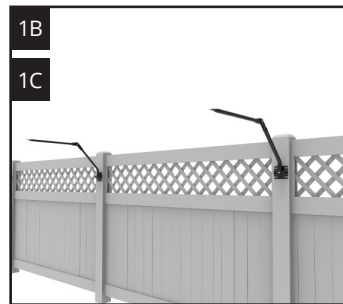

### Determine Desired Fence Height

- 1A.** Each Arm is secured with one mounting plate on each of your fence posts.
- 1B.** The mounting plates can be spaced up to 14 ft apart (though 8-10 ft is preferred) which may mean you can skip posts in some fence layouts.
- 1C.** For maximum effectiveness, it is important that the finished height of your Purrfect Fence extensions (measured from the ground to the tip of the arm) be tall enough so your cat cannot leap on top or over it. For most domestic cats the minimum height we recommend is 6 ft, though taller is better and possibly necessary for some larger and more capable jumpers.

### FOR WOOD FENCES

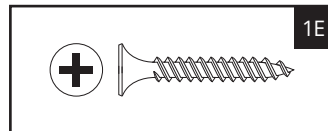
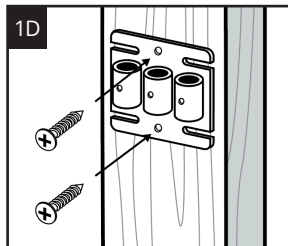

### Secure Mounting Plate To The Fence Post

**1D.** Use 2 bugle-head screws ( **1E** ) per mounting plate.

**Note:** Wood fasteners not included with kit.

### FOR VINYL / PVC FENCES

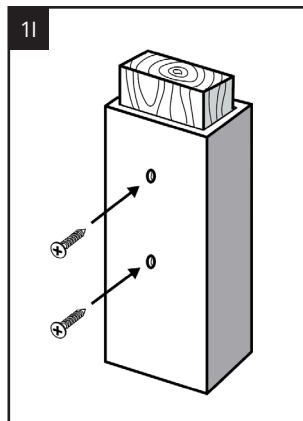
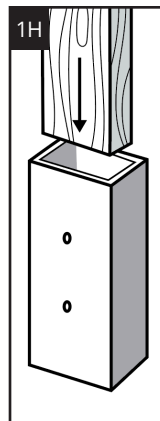
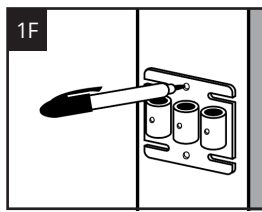

### Secure Mounting Plate To The Fence Post

**1F.** Use a marker to mark the fence post where the mounting plate will be secured.

**1G.** Drill pilot holes where you marked the fence post.

**1H.** If securing to a hollow fence post, remove post cap and insert a 12"- 18" long pressure treated wood.

**1I.** Drive a 1-1/2" long wood screw (*not included*) through the mounting plate and post into the wood.

**Note:** If you cannot secure to a fence post or have questions about installing on a vinyl or PVC fence, please contact Purrfect Fence for more information.



**1 SECURE THE MOUNTING PLATES TO YOUR FENCE (CONTINUED)**

**FOR METAL FENCES (WITH ROUND OR SQUARE POSTS)**

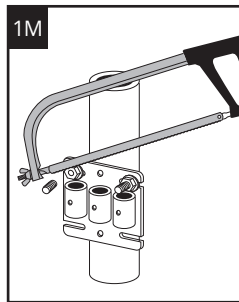
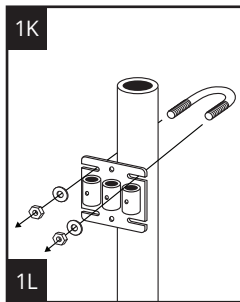
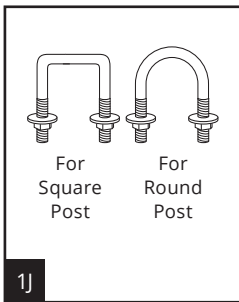

**Secure Mounting Plates To The Fence Post**

- 1J.** Use appropriate size U-bolt to attach the mounting plate to your fence post (*sold separately*).
- 1K.** Two U-bolts are needed per mounting plate (top and bottom).
- 1L.** Use one mounting plate per post.
- 1M.** Use a metal hacksaw, bolt cutters, or similar to remove the excess U-bolt threading and ensure that the arms will fit in the outer mounting plate rings when necessary.

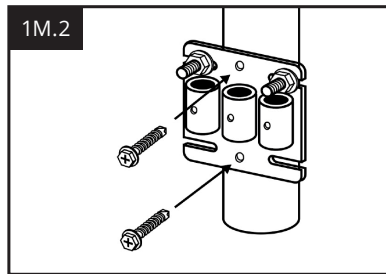
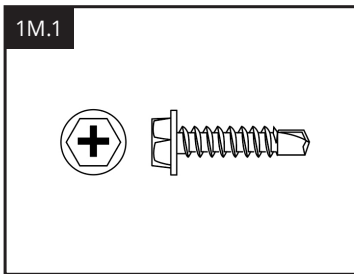

**Alternative Fastener Option**

- 1M.1** An alternative option to securing with U-bolts and cutting excess threading at gates and endpoints is to secure the mounting plate with self-tapping metal screws (*not included*).
- 1M.2** Use a U-bolt to hold the mounting plate in place temporarily and secure with two self-tapping metal screws. Once the self-tapping screws are installed, remove the U-bolt.

**FOR MASONRY WALLS / BRICK**

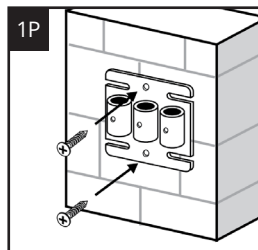
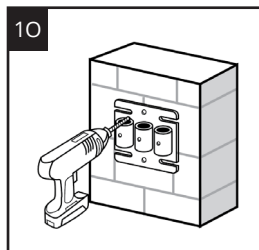
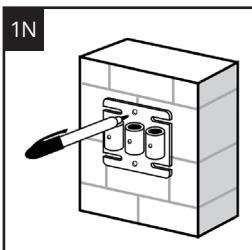

**Secure Mounting Plates To The Wall**

- 1N.** Use a marker to mark the wall where the mounting plate will be secured.
- 1O.** Use a masonry bit to drill pilot holes where you marked the fence post or wall.
- 1P.** Drive a concrete or masonry screw (*not included*) through the mounting plate and into the wall.

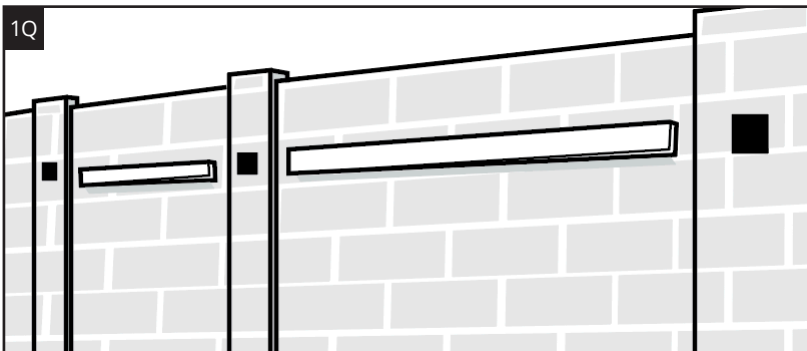

**Note:** If possible, align the holes of the mounting plate along a mortar joint. This will make repair easier if the Purrfect Fence is removed.

- 1Q. Optional:** Secure wood strips (*not included*) between mounting plates. The wood strip will be utilized in step 5.



## 2 INSERT ARMS INTO THE MOUNTING PLATES

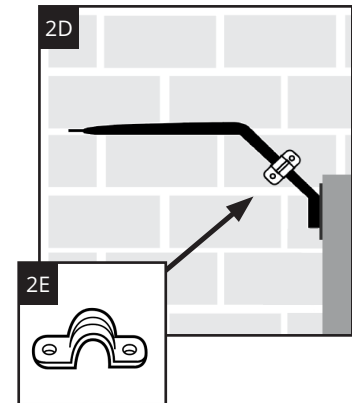
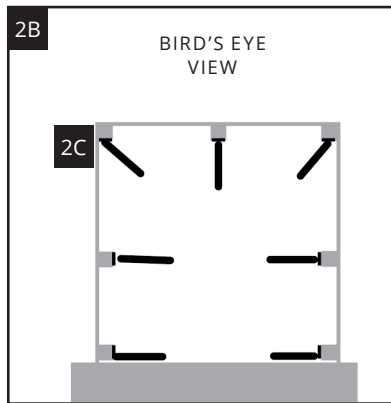
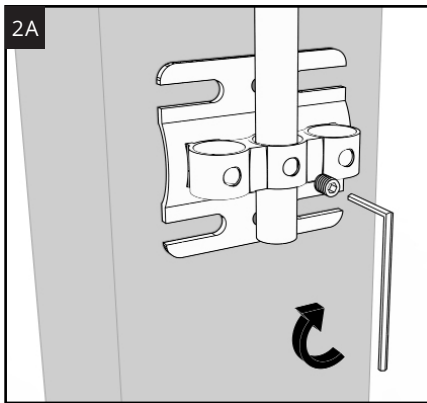

**2A.** To secure arms into mounting plates, slide the base of the arm through the appropriate ring (The center ring is used in most cases; Left or right ring in corners, end points, and gate areas). Using the provided hex wrench, thread set screw into hole on front of ring.

**2B.** Arms should point perpendicular to the fence line except for where the fence turns.

**2C.** Arms in corners that are between 90-degrees and 180 degrees should be angled to split the corner into two equal halves using the ring that is closest to the center of the angle and extends farthest into the enclosure.

**2D.** Where the fence ends at a building or structure, the arm should be secured to the building by strapping the non-pivoting part of the arm just below the spring joint to the building using appropriate screws and the included arm-to-wall straps ( **2E** ).

**Note:** Any of the 3 rings on the mounting plate can be used when necessary. Multiple arms can be used on the same mounting plate when needed for outside corners, gates, and more complex situations. Please contact Purrfect Fence for more information.

## 3 FOR OPENING GATES

### FOR INWARD SWINGING GATES

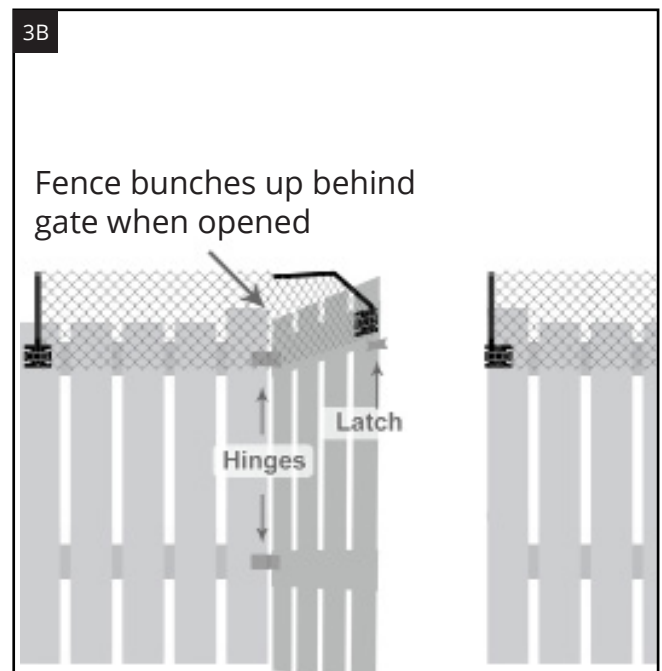
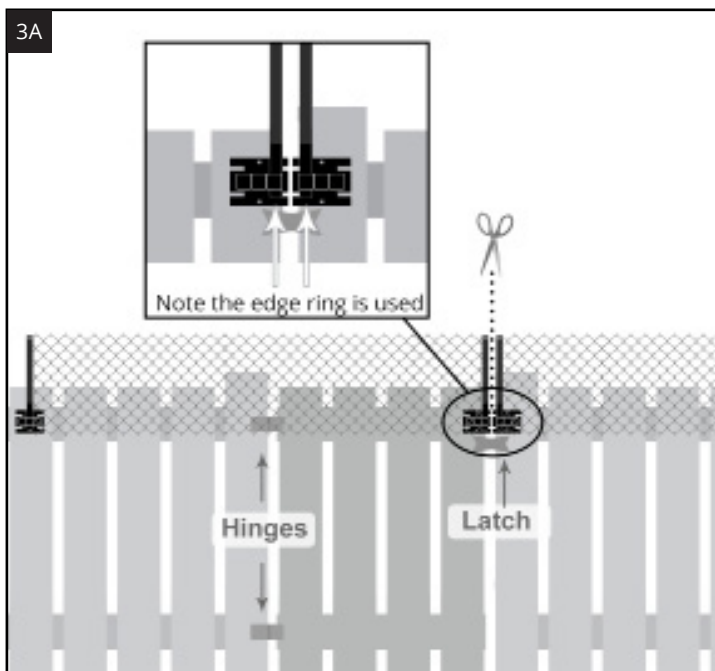



**3 FOR OPENING GATES (CONTINUED)**

**FOR OUTWARD SWINGING GATES**

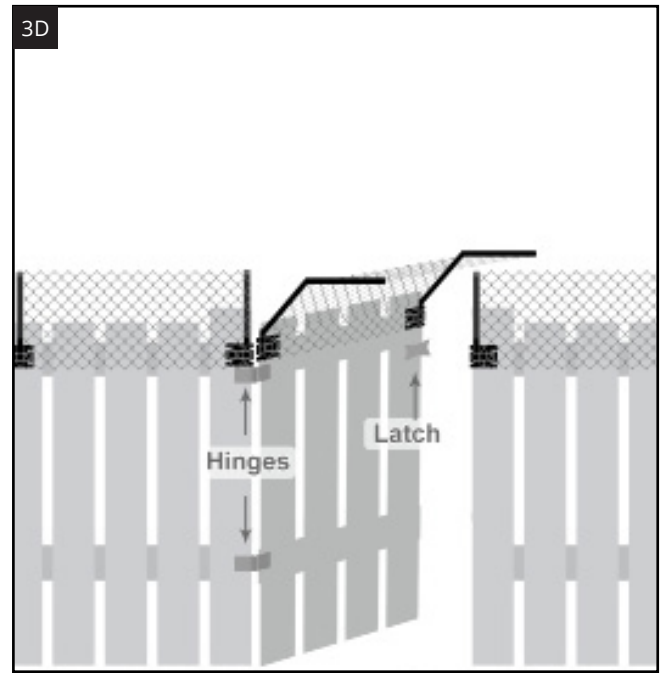
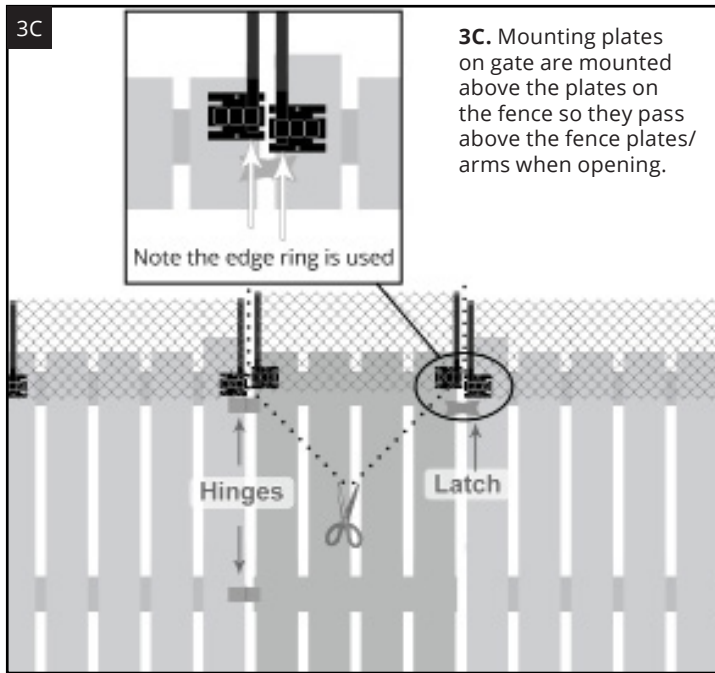

**4 ATTACH MESH FENCE MATERIAL**

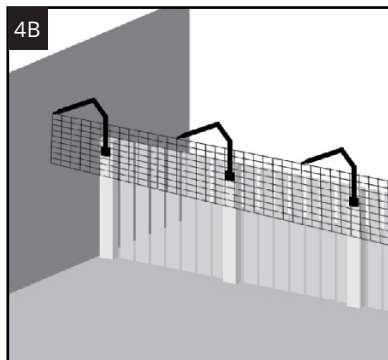
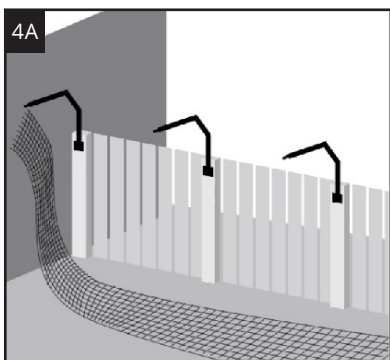

**Install Mesh Fence One Side at a Time**

**4A.** Unroll the mesh fence then lift the top edge up to the tip of the arm. Using the included zip ties, secure the top edge of the mesh to the tip of the arm. Tighten the zip tie and cut off the excess tab. Repeat for each arm along the side. Do not try to pull the mesh overly tight between arms.

**4B.** Now the fence should be hanging from the tips of all the arms on a side.

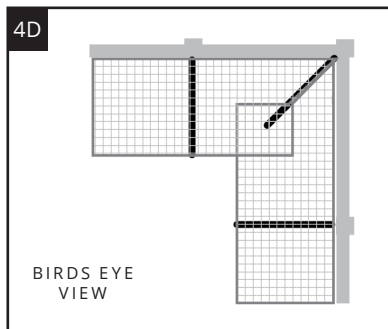
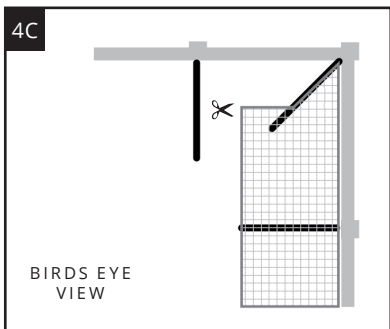

**Inside Corners**

**4C.** At corners the arms are angled relative to the rest of the arms in the sections which makes them "shorter." To adjust for this, attach the mesh fence 4 squares in from the edge at the tip of the arm.

**4D.** Run the fence slightly past the existing fence corner and cut the fence off the roll.



## 4 ATTACH MESH FENCE MATERIAL (CONTINUED)

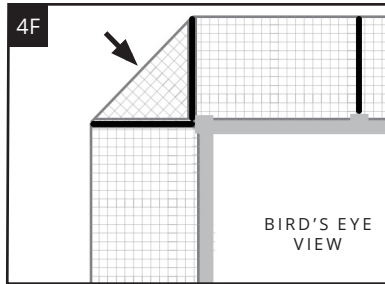
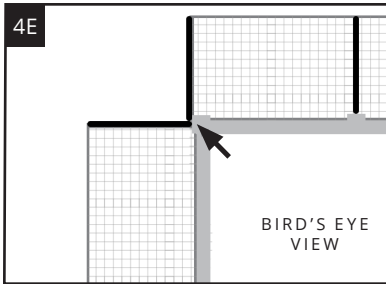

### Outside Corners

- 4E.** Outside corners require 1 (optionally 2) mounting plates and 2 arms.
- 4F.** Cut fence on turns. A separate piece of mesh fence is required for the outside corner between the arms.

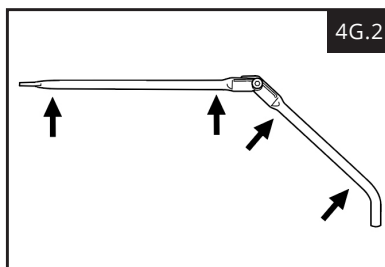
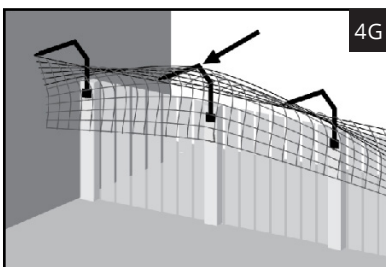

### Install Mesh Fence One Side at a Time

- 4G.** Lift the middle of the hanging mesh fence up and secure to the arm where shown ( **4G.2** ) with included zip ties.
- 4H.** Continue lifting the mesh fence and securing it to the arms with zip ties until all arms are secured to the mesh fence on a side.

**Optional:** Remove excess tab of zip ties with snips or Zip Tie Tool (sold separately).

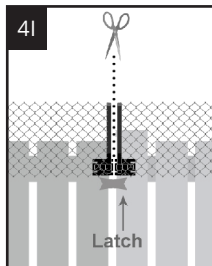

- 4I.** At gates, cut the mesh fence between the arms to allow the gate to open.

**Note:** Refer to diagrams **4C** and **4D** for cut pattern of excess mesh fence at corners.

## 5 SECURING BOTTOM OF MESH FENCE

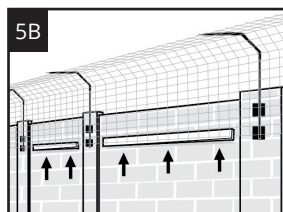
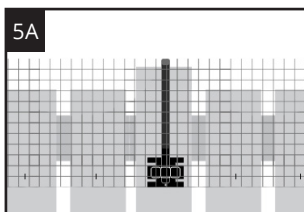
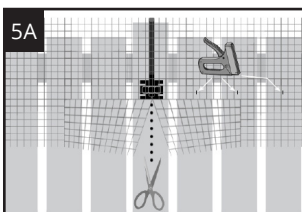

- 5A. Wood Fence** - When the mounting plate is secured to the post, cut the fence vertically at the post below the mounting plate. Staple the mesh fence to the fence (staple gun sold separately) and cut off the excess fence.

- 5B. Masonry Wall** - Staple the bottom edge of mesh fence to the wood strip installed in "Step 1Q". Or, use "PVC/Wall kit" ( **5D** ).

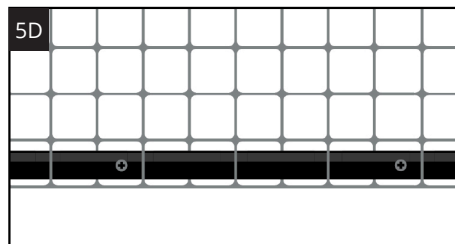
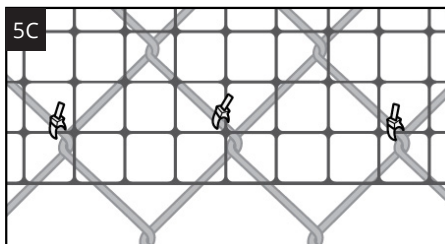

- 5C. Metal Fence** - Secure the bottom of mesh fence to the chainlink or metal fence with zip ties or hogrings (sold separately).

<https://www.purrfectfence.com/products/hog-ringer-2-500-hog-rings>

- 5D. Vinyl / PVC Fence** - Use "PVC/Wall kit" (sold separately).

<https://www.purrfectfence.com/products/pvc-fence-wall-kit>