



INCLUDED PARTS:

(24) Arm Mounting Plates
(24) Set Screws
(1) Hex Wrench (for set screws)

(12) Spring-Loaded Arms
(12) Arm Extension Tubes
(3) Single-Use Epoxy Packs

(2) Bag (100) Zip Ties
(1) 6ft x 100ft Heavy Duty Poly Mesh Fence Roll
(2) Arm to Wall Straps

Please note:

Fasteners to attach the mounting plates to your fence or wall are not included. The appropriate fasteners needed for different fence types are addressed within the instructions. In addition, the components listed above are for a 100ft kit. If you ordered more or less than 100ft, your components may vary.

1 ASSEMBLE THE ARMS AND ARM EXTENSION TUBES

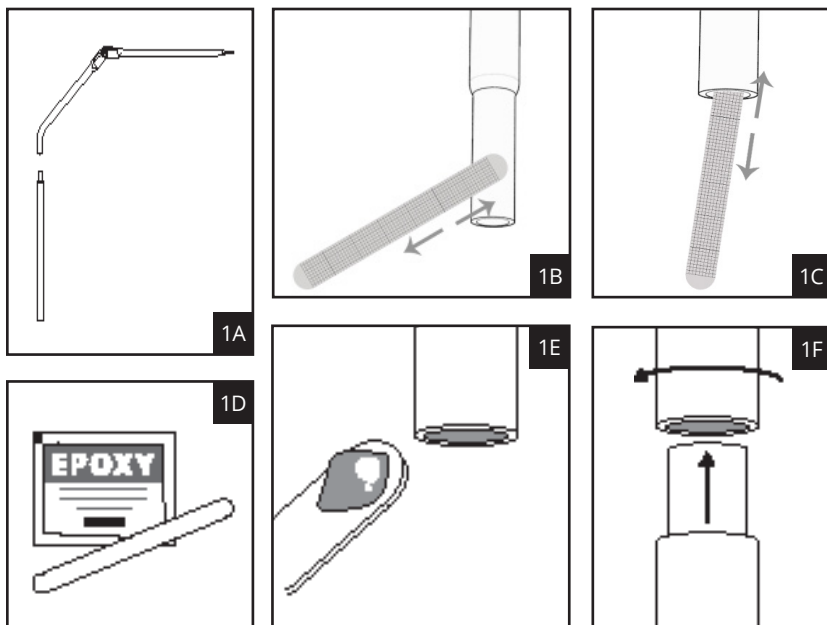

Permanent Connection Using Epoxy

1A. Lay the pieces out that require a permanent secure connection as shown.

Note: Each epoxy pack is good for 3-4 tube connections.

1B. Use included sanding file to score (scuff up) the outer surface of the *male* end (crimped end of extension tube). Visibly light scratches are sufficient.

1C. Use included sanding file to score (scuff up) the inner surface of the *female* end (base of arm). Visibly light scratches are sufficient.

1D. Mix a pack of the two-part epoxy to create the adhesive effect. Each epoxy packet has two agents that must be mixed and stirred to create a glue outcome.

Use the mixing stick as a squeegee to remove all epoxy from both packets (epoxy must be mixed with equal parts of both packets). After mixing, you will have 5-minutes of working time to apply the epoxy before it dries.

1E. Use the epoxy mixing stick to place a pea-sized amount of epoxy inside the *female* end of tubing.

1F. Slide the male end into female end. Rotate the tube (1 full turn) to spread the epoxy then gently wipe off any excess epoxy. Set aside for at least 15 minutes to dry before installation.

PLEASE NOTE: Your order may have included an epoxy syringe.

This epoxy syringe is a substitute for single-use epoxy packs and is good for approximately 32-36 tube connections. Please read the instructions on the back side of the epoxy syringe packaging as the set time varies slightly.

When you reach **step 1D**, mix a small amount epoxy from the syringe at a time working in batches to be sure you are able to utilize the glue before it hardens.

2 SECURE THE MOUNTING PLATES TO YOUR FENCE

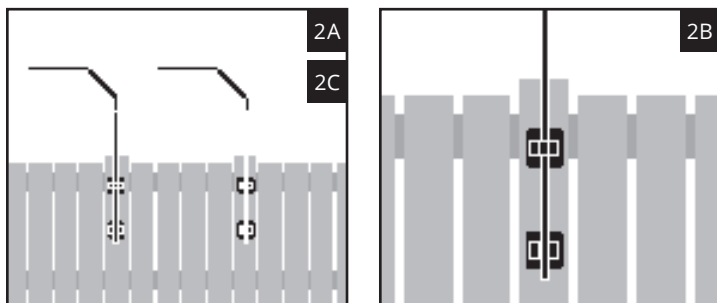

Determine Desired Fence Height

2A. Each Arm / Extension assembly is secured with two mounting plates on each of your fence posts. Assemblies can be spaced up to 14 ft apart (though 8-10 ft is preferred).

2B. The mounting plates should be at least 3" apart vertically. They can be farther if you are not trying to maximize overall Purrfect Fence height.

2C. For maximum effectiveness, it is important that the finished height of your Purrfect Fence extensions (measured from the ground to the tip of the arm) be tall enough so your cat cannot leap on top or over it. For most domestic cats the minimum height we recommend is 6 ft, though taller is better and possibly necessary for some larger and more capable jumpers.

2 SECURE THE MOUNTING PLATES TO YOUR FENCE (CONTINUED)

FOR WOOD FENCES

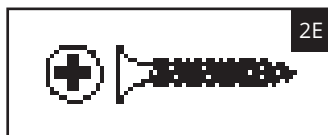
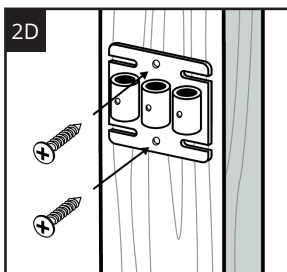

Secure Mounting Plates To The Fence

2D. Use 2 bugle-head screws (**2E**) per mounting plate.

Note: Wood fasteners not included with kit.

FOR METAL FENCES (WITH ROUND OR SQUARE POSTS)

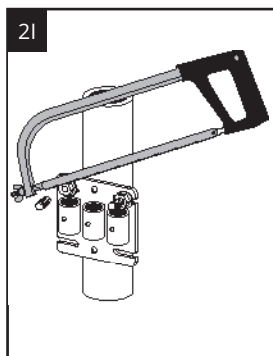
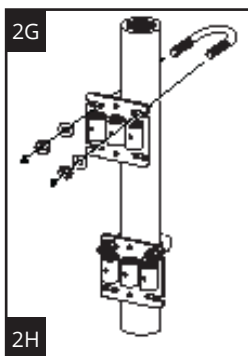
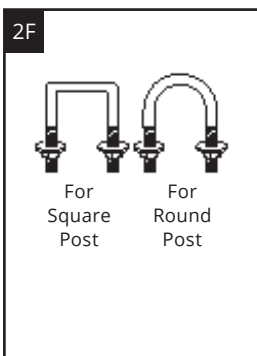

Secure Mounting Plates To The Fence Post

2F. Use appropriate size U-bolt to attach the mounting plate to your fence post (*sold separately*).

2G. Only one U-bolt is needed per mounting plate.

2H. Use two mounting plates per post.

2I. Use a metal hacksaw, bolt cutters, or similar to remove the excess U-bolt threading and ensure that the arms will fit in the outer mounting plate rings when necessary.

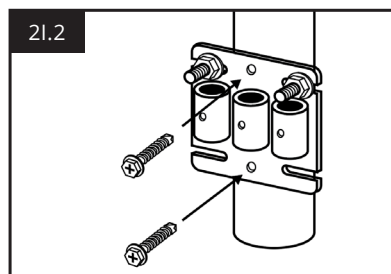
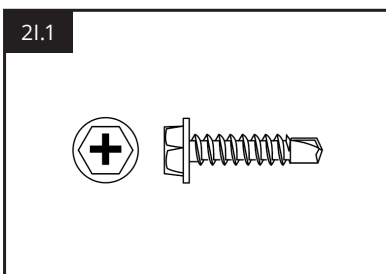

Alternative Fastener Option

2I.1 An alternative option to securing with U-bolts and cutting excess threading at gates and endpoints is to secure the mounting plate with self-tapping metal screws (*not included*).

2I.2 Use a U-bolt to hold the mounting plate in place temporarily and secure with two self-tapping metal screws. Once the self-tapping screws are installed, remove the U-bolt.

FOR VINYL / PVC FENCES

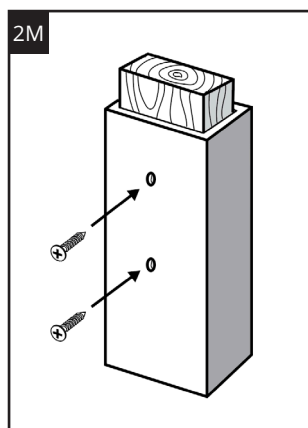
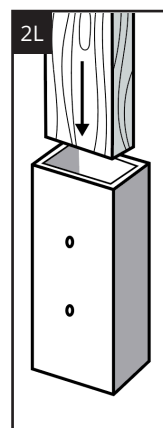
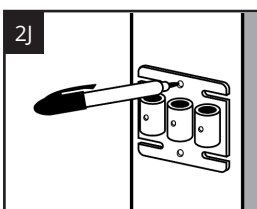

Secure Mounting Plates To The Fence Post

2J. Use a marker to mark the fence post where the mounting plate will be secured.

2K. Drill pilot holes where you marked the fence post.

2L. If securing to a hollow fence post, remove post cap and insert a 12" - 18" long pressure treated wood.

2M. Drive a 1-½" long wood screw (*not included*) through the mounting plate and post into the wood.

Note: If you cannot secure to a fence post or have questions about installing on a vinyl or PVC fence, please contact Purrfect Fence for more information.

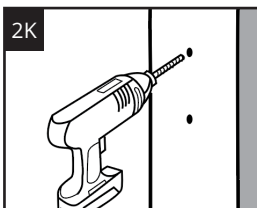

2 SECURE THE MOUNTING PLATES TO YOUR FENCE (CONTINUED)

FOR MASONRY WALLS / BRICK

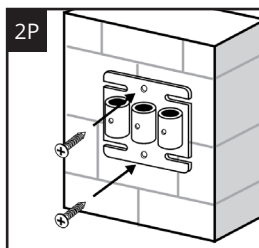
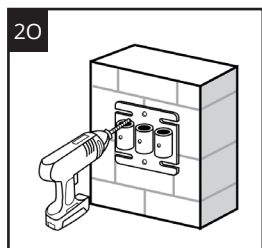
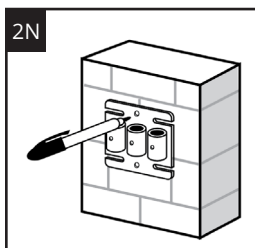

Secure Mounting Plates To The Wall

2N. Use a marker to mark the wall where the mounting plate will be secured.

2O. Use a masonry bit to drill pilot holes where you marked the fence post or wall.

2P. Drive a concrete or masonry screw (*not included*) through the mounting plate and into the wall.

Note: *If possible, align the holes of the mounting plate along a mortar joint. This will make repair easier if the Purrfect Fence is removed.*

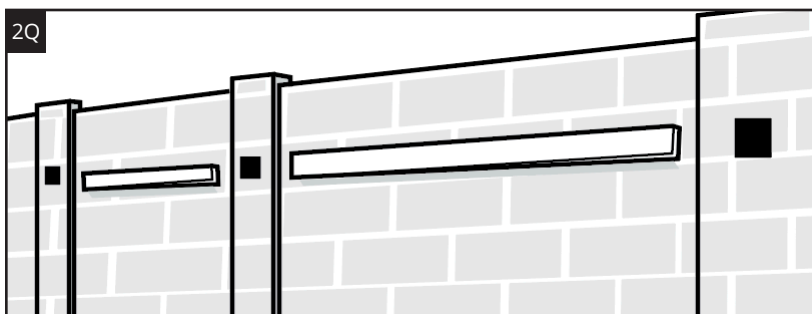

2Q. Optional: Secure wood strips (*not included*) between mounting plates. The wood strip will be utilized in step 6.

3 INSERT ARMS / EXTENSION TUBES INTO THE MOUNTING PLATES

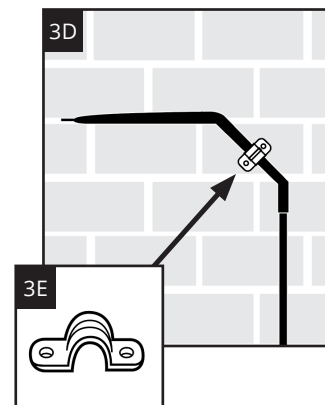
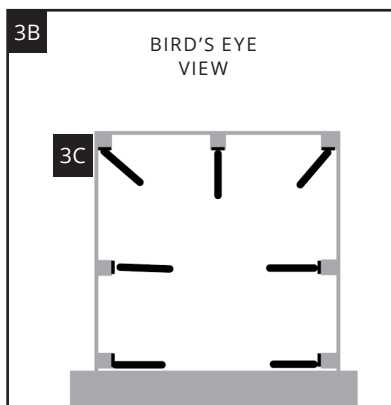
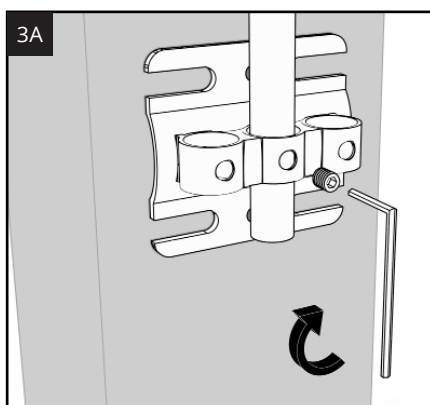

3A. To secure arm extensions into mounting plates, slide extension tubing through the appropriate ring (The center ring is used in most cases; Left or right ring in corners, end points, and gate areas). Using the provided hex wrench, thread set screw into hole on front of ring.

3B. Arms should point perpendicular to the fence line except where the fence turns.

3C. Arms in corners that are between 90-degrees and 180 degrees should be angled to split the corner into two equal halves using the ring that is closest to the center of the angle and extends farthest into the enclosure.

3D. Where the fence ends at a building or structure, the arm should be secured to the building by strapping the non-pivoting part of the arm just below the spring joint to the building using appropriate screws and the included arm-to-wall straps (**3E**).

Note: *Any of the 3 rings on the mounting plate can be used when necessary. Multiple arms can be used on the same mounting plate when needed for outside corners, gates, and more complex situations. Please contact Purrfect Fence for more information.*

4 FOR OPENING GATES

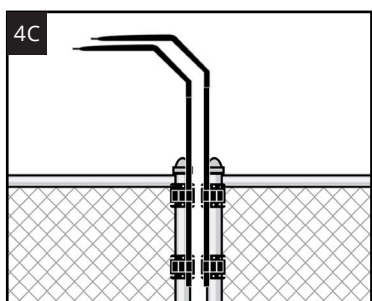
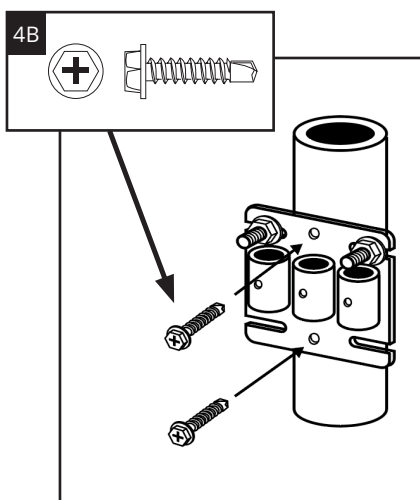
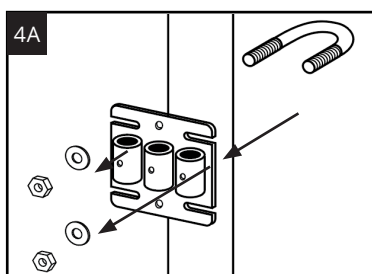

Secure Mounting Plates To The Gate

Gates and/or gate posts may not allow plates to be secured with U-bolts. In these areas, use the alternative fastener option below:

- 4A.** Use appropriate size U-bolt to attach the mounting plate to your gate post temporarily (*sold separately*).
- 4B.** Use self-tapping metal screws (*not included*) to secure the mounting plate to the gate post. Remove the U-bolt and insert the extension arm into the inner most ring of the mounting plate (**diagram 4C**).
- 4C.** For outward opening gates, stagger the heights of the arms by 2 inches so that they swing open freely.

5 ATTACH MESH FENCE MATERIAL

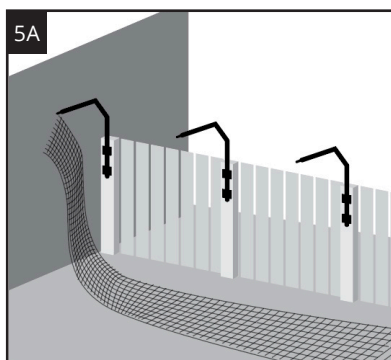

Install Mesh Fence One Side at a Time

- 5A.** Unroll the mesh fence then lift the top edge up to the tip of the arm. Using the included zip ties, secure the top edge of the mesh to the tip of the arm. Tighten the zip tie and cut off the excess tab. Repeat for each arm along the side. Do not try to pull the mesh overly tight between arms.
- 5B.** Now the fence should be hanging from the tips of all the arms on a side.

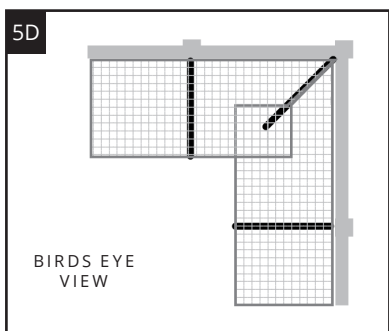
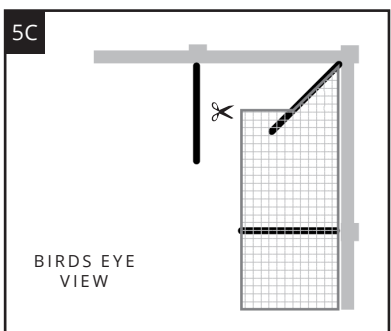

Inside Corners

- 5C.** At corners the arms are angled relative to the rest of the arms in the sections which makes them "shorter." To adjust for this, attach the mesh fence 4 squares in from the edge at the tip of the arm.
- 5D.** Run the fence slightly past the existing fence corner and cut the fence off the roll.

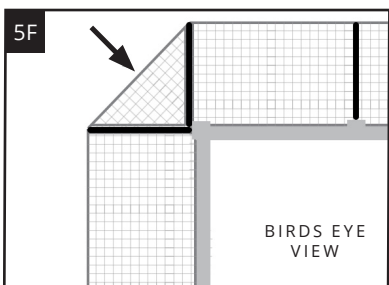
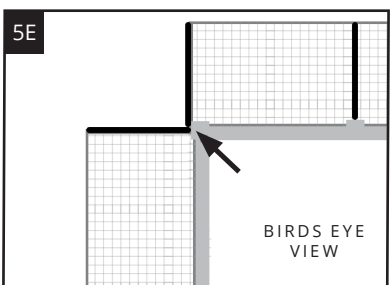

Outside Corners

- 5E.** Outside corners require 1 (optionally 2) mounting plate sets and 2 arms.
- 5F.** Cut fence on turns. A separate piece of mesh fence is required for the outside corner between the arms.

5 ATTACH MESH FENCE MATERIAL (CONTINUED)

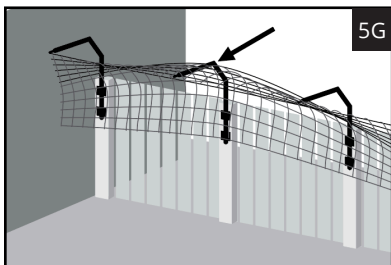

5G

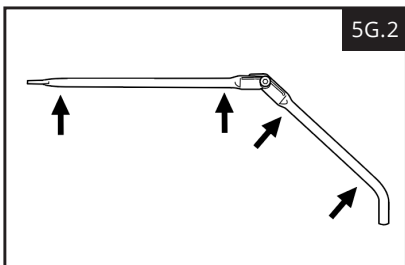

5G.2

Secure Mesh Fence to Arms

5G. Lift the middle of the hanging mesh fence up and secure to the arm where shown (**5G.2**) with included zip ties. 2-3 additional zip ties can be added down the extension tube.

5H. Continue lifting the mesh fence and securing it to the arms with zip ties until all arms are secured to the mesh fence on a side.

Optional: Remove excess tab of zip ties with snips or Zip Tie Tool (sold separately).

5I. At gates, cut the mesh fence between the arms to allow the gate to open.

Note: Refer to diagrams **5C** and **5D** for cut pattern of excess mesh fence at corners.

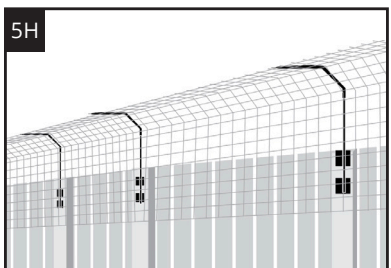

5H

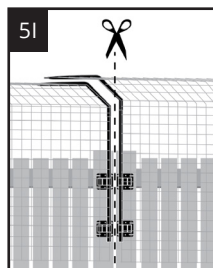

5I

6 SECURING BOTTOM OF MESH FENCE

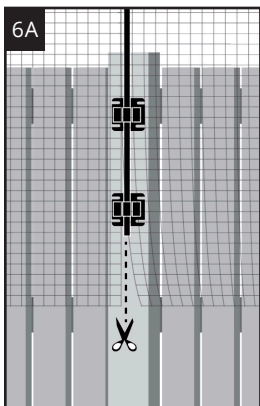

6A

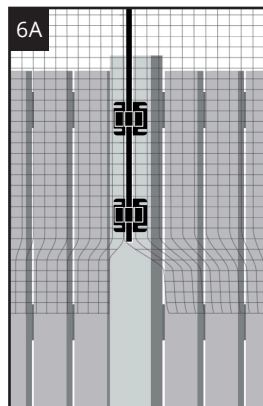

6A

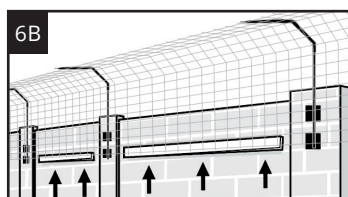

6B

6A. Wood Fence - When the mounting plate is secured to the post, cut the fence vertically at the post below the mounting plate. Staple the mesh fence to the fence (staple gun sold separately) and cut off the excess fence.

6B. Masonry Wall - Staple the bottom edge of mesh fence to the wood strip installed in "Step 2D".

Or, use "PVC/Wall kit" (**6D**).

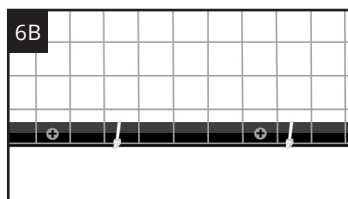

6B

6C. Metal Fence - Secure the bottom of mesh fence to the chainlink or metal fence with zip ties or hogrings (hogringer & rings sold separately).

<http://store.purrfectfence.com/product-p/hogringer-rings.htm>

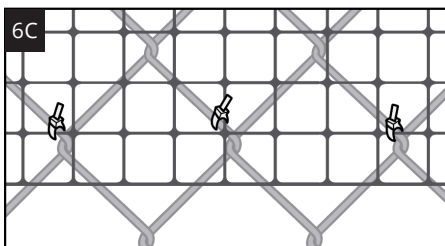

6C

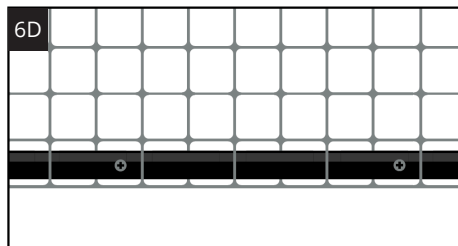

6D

6D. Vinyl / PVC Fence - Use "PVC/Wall kit" (sold separately).

<http://store.purrfectfence.com/product-p/pvc-wallkit.htm>