

# ALUMINUM PROFILE

廠家

ALUMINUM PROFILE

# 铝型材套件



## 铝型材套件

专业铝型材套件供应商

主营：I 铝材外壳（硬灯条、线条灯、办公照明、磁吸灯）  
II 铝材折弯/异型定制 III（光源/电源）配套

专业铝型材套件供应商

主营：I 铝材外壳（硬灯条、线条灯、办公照明、磁吸灯）  
II 铝材折弯/异型定制 III（光源/电源）配套

2022产品目录

## 办公灯 凤铝高端系列

P01-P09

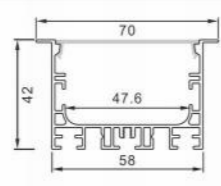

型号: 5842A/03页

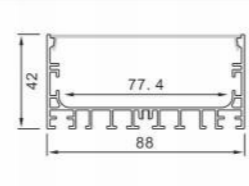

型号: 8842M/06页

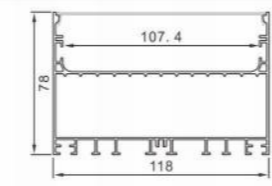

型号: 11878M/08页

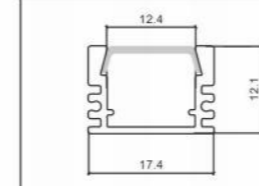

型号: 505/11页

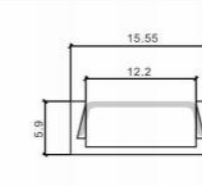

型号: 610/13页

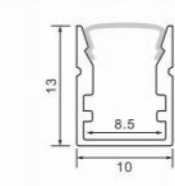

型号: 624/15页

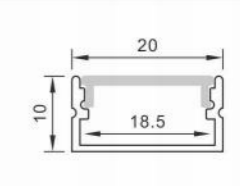

型号: 2010M/17页

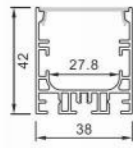

型号: 3842M/02页

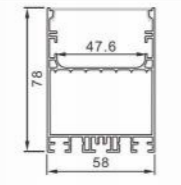

型号: 5878M/04页

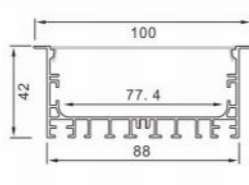

型号: 8842A/06页

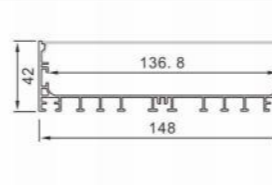

型号: 14842M/08页

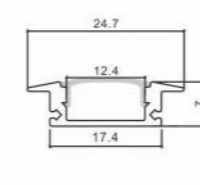

型号: 508/11页

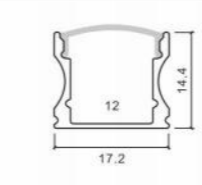

型号: 613/13页

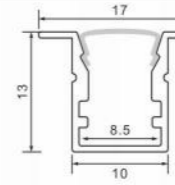

型号: 624A/15页

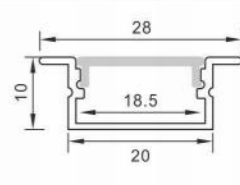

型号: 2010A/17页

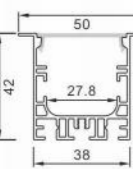

型号: 3842A/02页

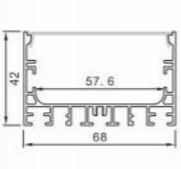

型号: 6842M/04页

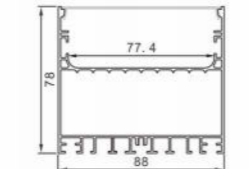

型号: 8878M/06页

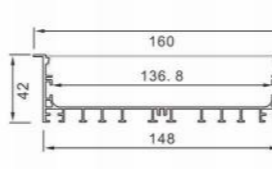

型号: 14842A/08页

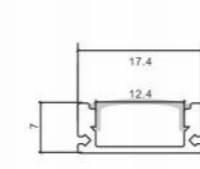

型号: 509/11页

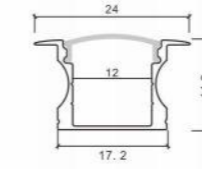

型号: 613B/13页

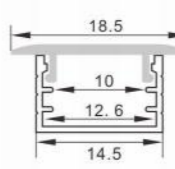

型号: MA-1/15页

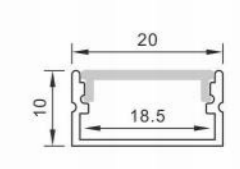

型号: 2010M加厚款/17页

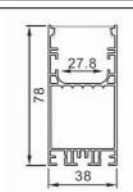

型号: 3878M/02页

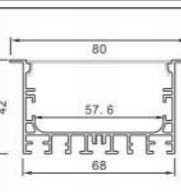

型号: 6842A/04页

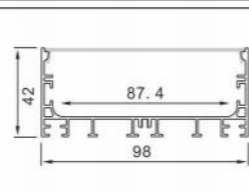

型号: 9842M/06页

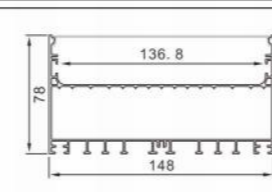

型号: 14878M/09页

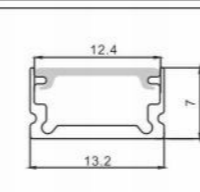

型号: 510/11页

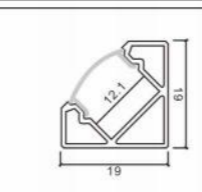

型号: 614/13页

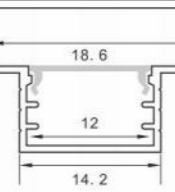

型号: 1409A/15页

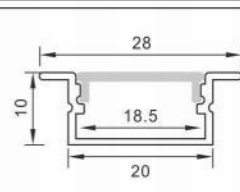

型号: 2010A加厚款/18页

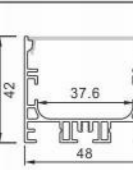

型号: 4842M/02页

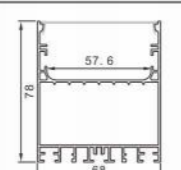

型号: 6878M/04页

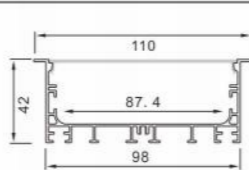

型号: 9842A/07页

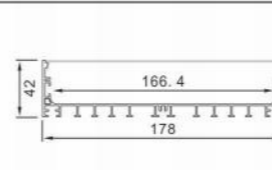

型号: 17842M/09页

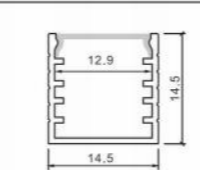

型号: 524/12页

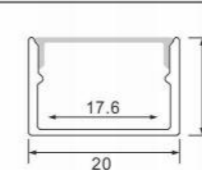

型号: 616/14页

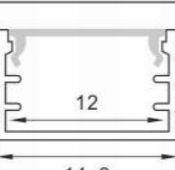

型号: 1409M/16页

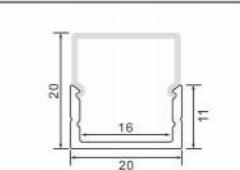

型号: 2011/18页

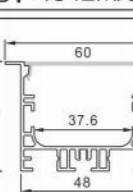

型号: 4842A/03页

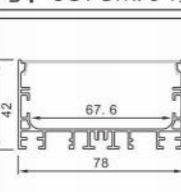

型号: 7842M/05页

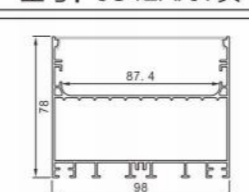

型号: 9878M/07页

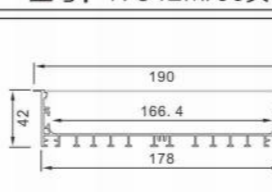

型号: 17842A/09页

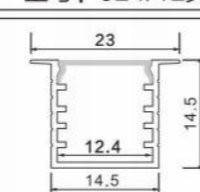

型号: 524A/12页

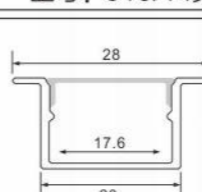

型号: 616A/14页

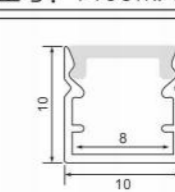

型号: 1010M/16页

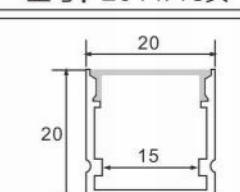

型号: 2020M/18页

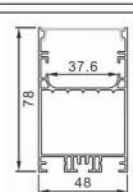

型号: 4878M/03页

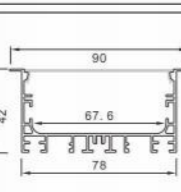

型号: 7842A/05页

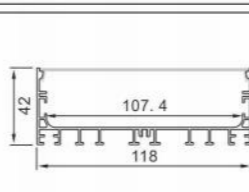

型号: 11842M/07页

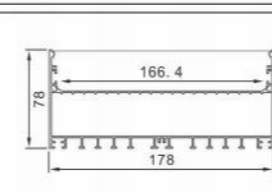

型号: 17878M/09页

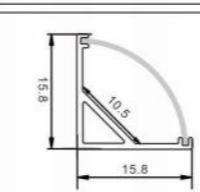

型号: 601/12页

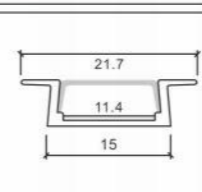

型号: 618/14页

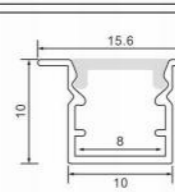

型号: 1010A/16页

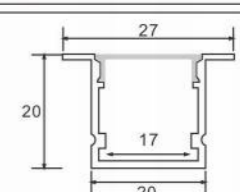

型号: 2020A/18页

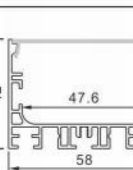

型号: 5842M/03页

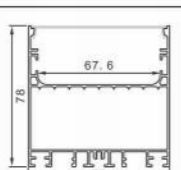

型号: 7878M/05页

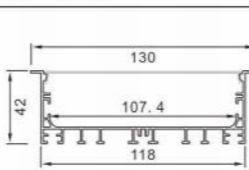

型号: 11842A/08页

## 硬灯条 铝型材套件

P10-P20

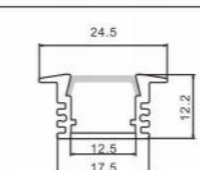

型号: 605/12页

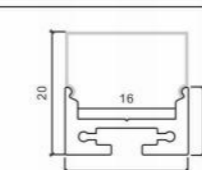

型号: 623/14页

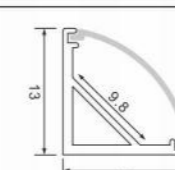

型号: 1313/16页

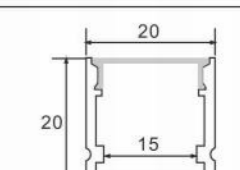

型号: 2020M厚款/19页

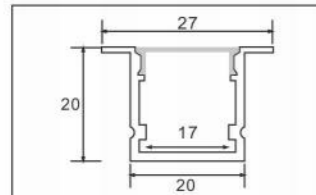

型号: 2020A厚款/19页

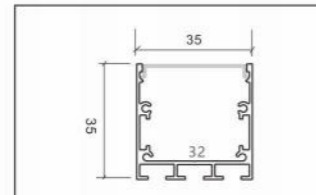

型号: 3535M/22页

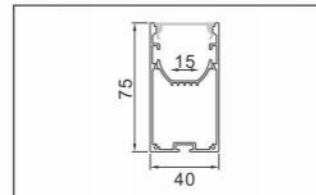

型号: 4075M/24页

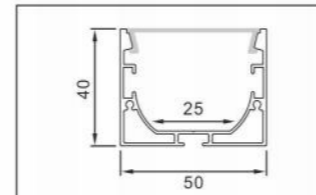

型号: 5040M/26页

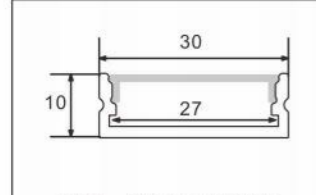

型号: 3010M/19页

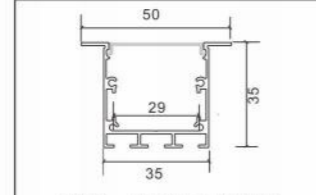

型号: 3535A/22页

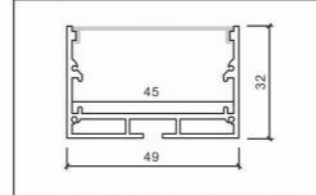

型号: 706/24页

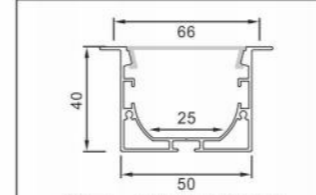

型号: 5040A/26页

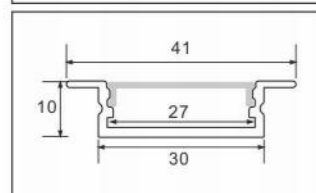

型号: 3010A/19页

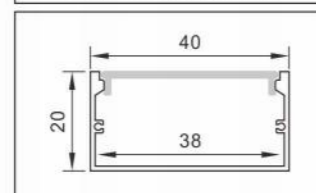

型号: 4020M/22页

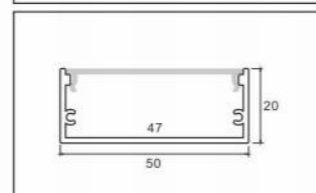

型号: 5020M/24页

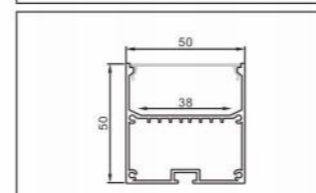

型号: 5050M/26页

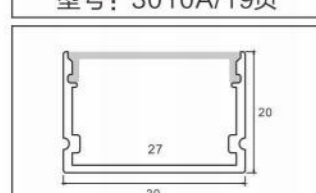

型号: 3020M/20页

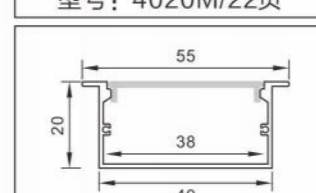

型号: 4020A/22页

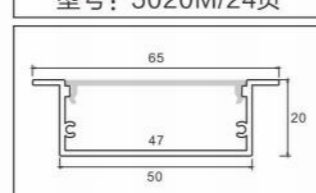

型号: 5020A/24页

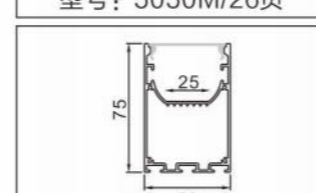

型号: 5075M/27页

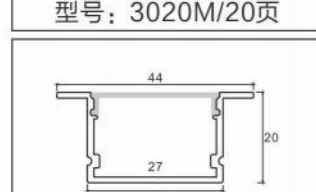

型号: 3020A/20页



型号: 4035M/23页



型号: 5035M/25页

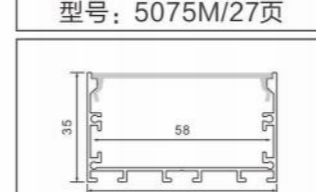

型号: 6035M/27页



型号: 3030M/20页



型号: 4035A/23页



型号: 5035A/25页



型号: 6035A/27页



型号: 3030A/20页



型号: 4040M/23页



型号: 5035M厚款/25页

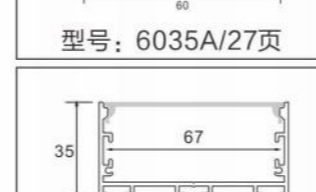

型号: 7035M/28页



型号: 4040A/23页



型号: 5035A厚款/26页

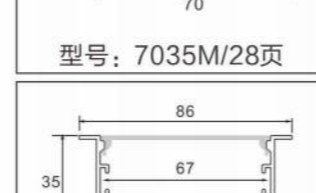

型号: 7035A/28页

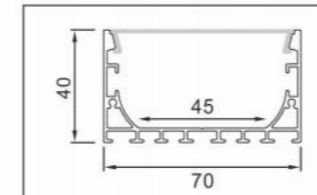

型号: 7040M/28页

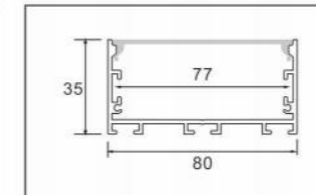

型号: 8035M/30页

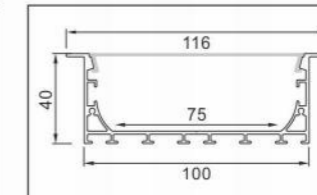

型号: 10040A/32页

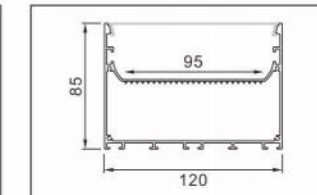

型号: 12085M/34页

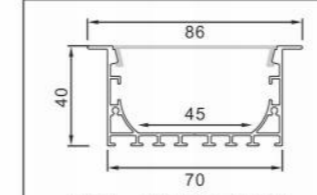

型号: 7040A/28页

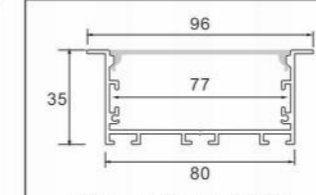

型号: 8035A/30页

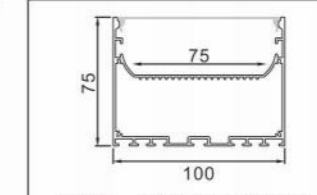

型号: 10075M/32页

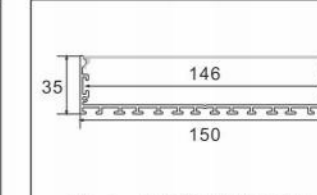

型号: 15035M/35页

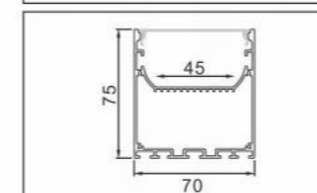

型号: 7075M/29页

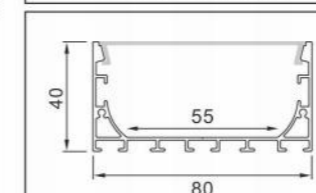

型号: 8040M/31页

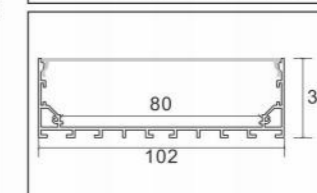

型号: 10235M/33页

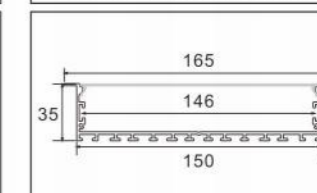

型号: 15035A/35页

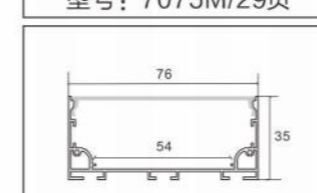

型号: 7635M/29页

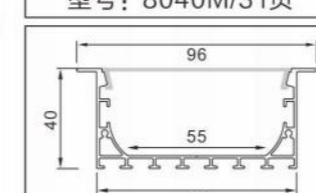

型号: 8040A/31页

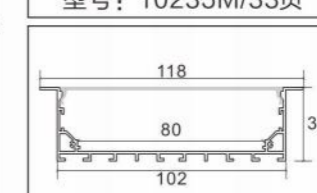

型号: 10235A/33页

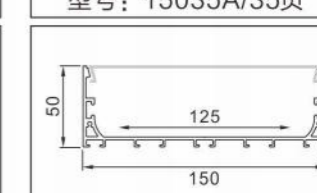

型号: 15050M35页

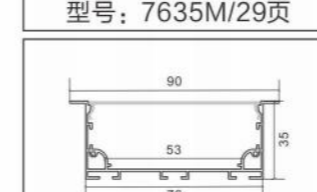

型号: 7635A/29页

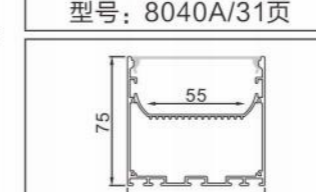

型号: 8075M/31页

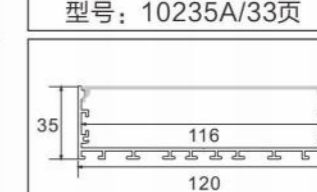

型号: 12035M/33页

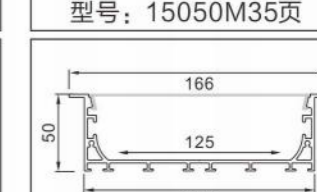

型号: 15050A/35页



型号: 7635M厚款/29页



型号: 10035M厚款/31页

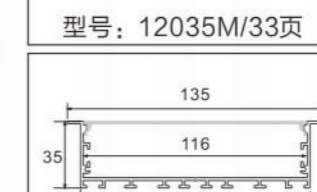

型号: 12035A/34页



型号: 15085M/36页



型号: 7635A厚款/30页

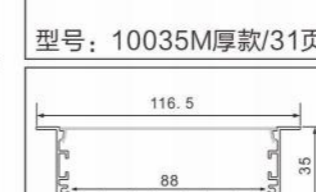

型号: 10035A厚款/32页

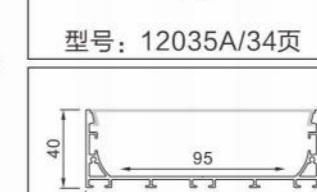

型号: 12040M/34页



型号: 20050M/36页



型号: 7676M/30页



型号: 10040M/32页

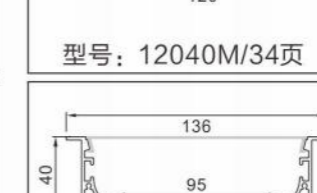

型号: 12040A/34页



型号: 20050A/36页

线条灯 (办公灯系列)

铝型材套件

P21-P36

## 夹层灯 铝型材套件

P37-P38

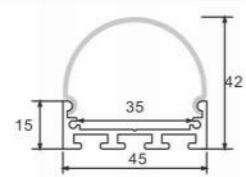

型号: 4542圆/40页

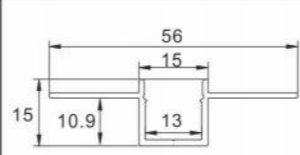

型号: 639米字/43页

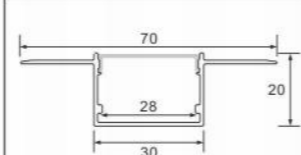

型号: 3020上花边/46页

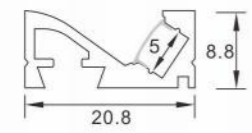

型号: 层板-明/38页

## 阴阳角线条灯 铝型材套件

P41-P46

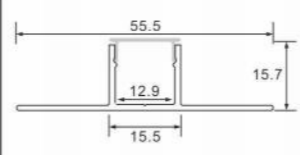

型号: 639米字下花边/44页

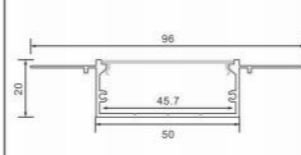

型号: 9620/46页

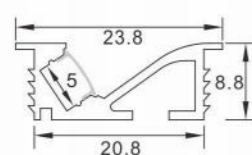

型号: 层板-暗/38页

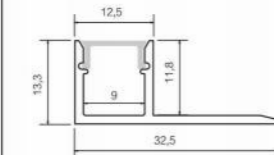

型号: 702/42页

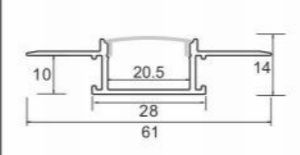

型号: 6114/44页

## 踩地线条灯 铝型材套件

P47-49

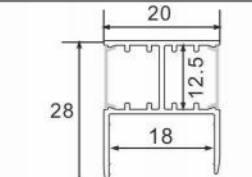

型号: 2028/38页

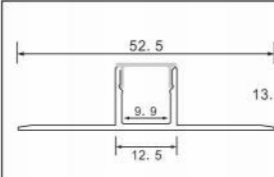

型号: 703/42页

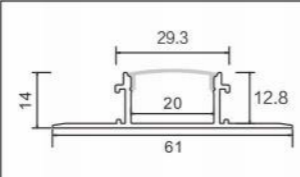

型号: 6114A/44页

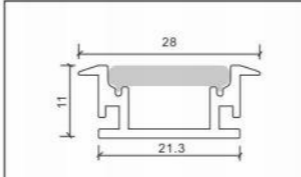

型号: 632-1/48页

## 多面发光线条灯 铝型材套件

P39-P40

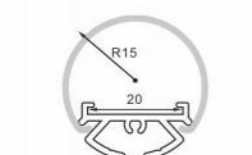

型号: Ø30/40页

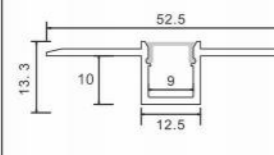

型号: 639新款/42页

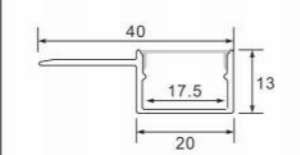

型号: 2013单花边/45页

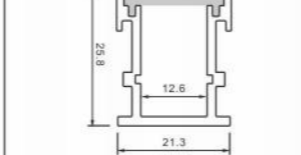

型号: 632/48页

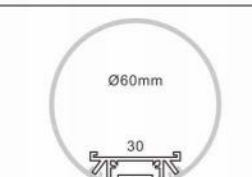

型号: Ø60/40页

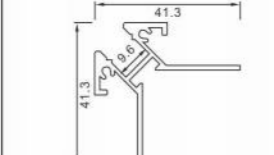

型号: 707阳角/42页

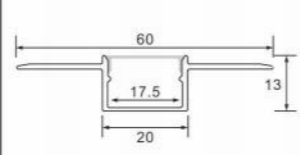

型号: 2013上花边/45页

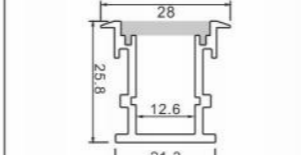

型号: 632A/48页

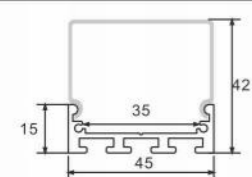

型号: 4542方/40页

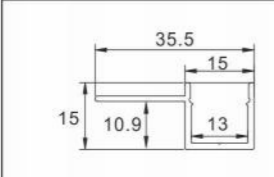

型号: 707阳角/43页

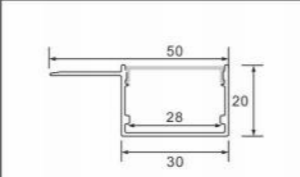

型号: 2013下花边/45页

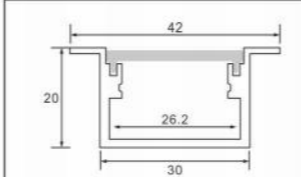

型号: 地踩3020M/49页



型号: 3020单花边/46页



型号: 地踩3020A/49页

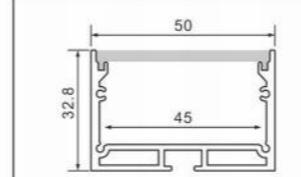

型号: 地踩5032M/49页

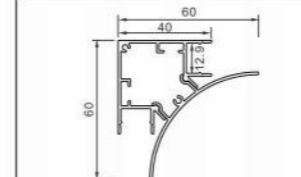

型号: 104/52页

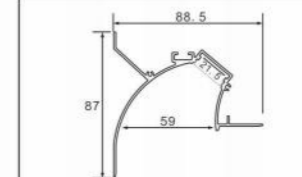

型号: 弧形花边加长款/55页

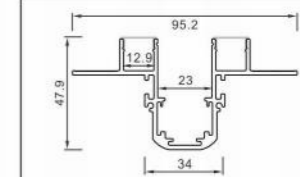

型号: 多发光轨道/58页

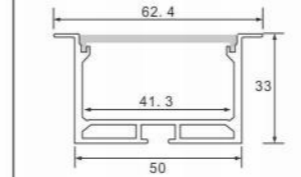

型号: 地踩5032A/49页

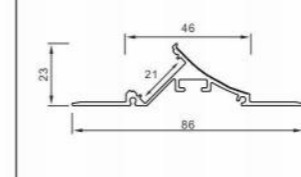

型号: 105/53页

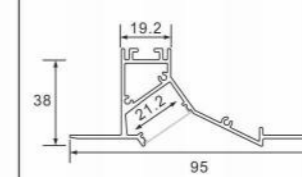

型号: 802/55页

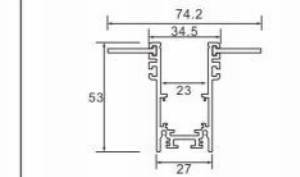

型号: 组合批灰轨道/58页

## 洗墙系列 铝型材套件

P50-P61

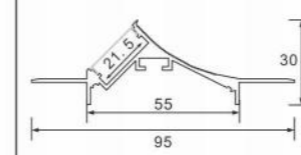

型号: 801/53页



型号: 半圆回光槽/55页

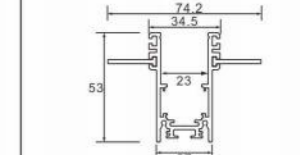

型号: 组合预埋轨道/58页

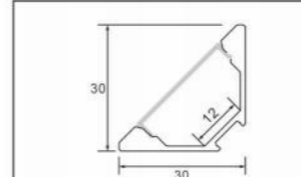

型号: 3030-L/51页

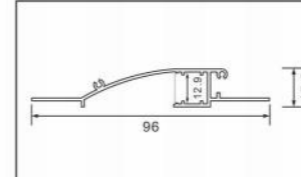

型号: 803/53页



型号: 2.0批灰轨道/57页

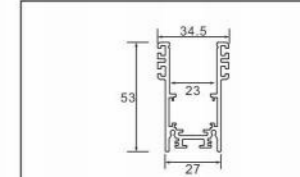

型号: 组合明装轨道/58页

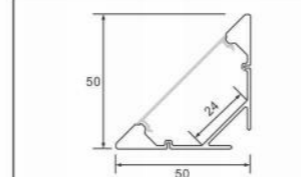

型号: 5050-L/51页

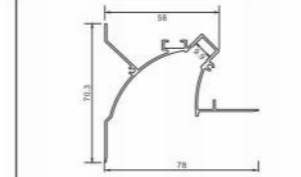

型号: 106/54页

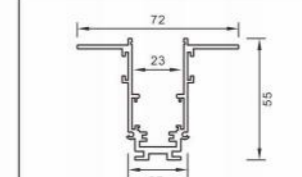

型号: 2.0暗装轨道/57页



轨道水平转角/59页

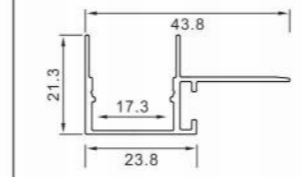

型号: 101/51页

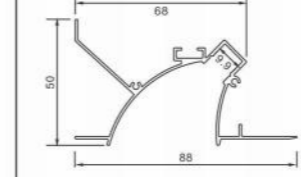

型号: 107/54页

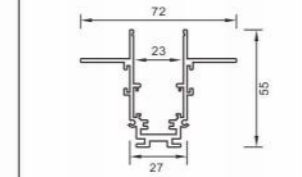

型号: 2.0明装轨道/57页



轨道垂直转角/59页



型号: 102/52页

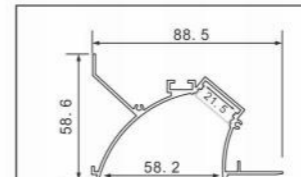

型号: 弧形花边/54页

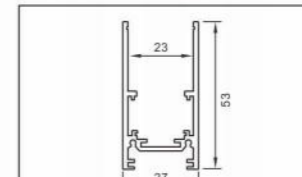

型号: 2.0明装轨道/57页



泛光灯/60页



型号: 103/52页

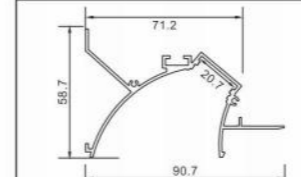

型号: 弧形预埋/54页

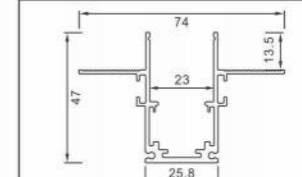

型号: CX-01/57页



格栅灯/60页

 轨道灯/60页	 磁吸灯内置电源	 宽卡扣(吸顶用)	
 折叠灯/61页	<b>转角配件</b> P63	 单边卡簧(嵌装开孔用)	
 模块/61页	 转角配件	 卡簧(嵌装开孔用)	
<b>光源</b> P62	<b>连接片配件</b> P63		
 软灯带光源	 连接片/63页		
 硬灯条光源	<b>吊线/卡扣/卡簧</b> P63		
<b>电源</b> P62	 吊线		
 台湾明纬开关电源	 王字卡扣(吸顶用)		

# 办公灯凤铝高端系列 铝型材套件

»» P01-P09



2022  
NEW STYLE

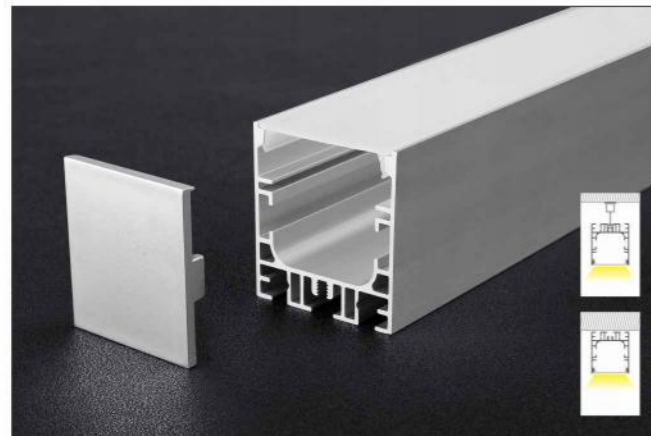

## 3842M

### 产品参数

尺寸: Lx38x42mm  
材质: 6063-T5 铝合金  
表面: 氧化铝本色/喷漆 (黑色/白色)  
PC罩: 乳白/黑色/亚克力磨砂可选  
适用: 20MM软灯带/硬灯条

### Description

size: Lx38x42mm  
Material: 6063-T5  
Surface: Silver / black / white Anodized  
PC cover: Milky white/black/acrylic matte  
Apply: LED Strips and PCB 20mm

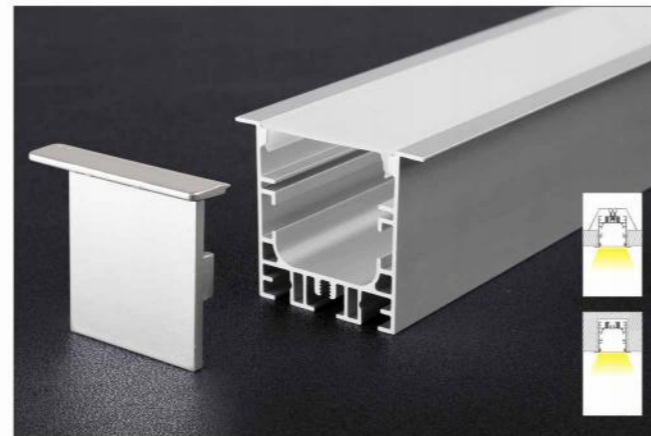
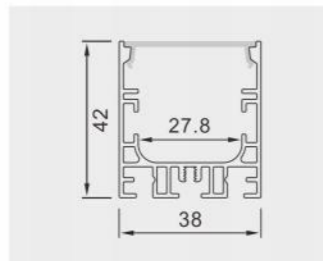

## 3842A

### 产品参数

尺寸: Lx50x42mm  
材质: 6063-T5 铝合金  
表面: 氧化铝本色/喷漆 (黑色/白色)  
PC罩: 乳白/黑色/亚克力磨砂可选  
适用: 20MM软灯带/硬灯条

### Description

size: Lx50x42mm  
Material: 6063-T5  
Surface: Silver / black / white Anodized  
PC cover: Milky white/black/acrylic matte  
Apply: LED Strips and PCB 20mm

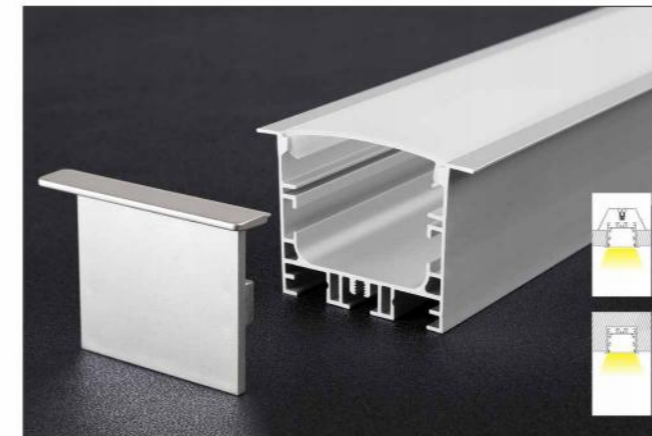
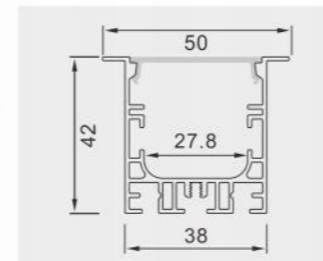

## 4842A

### 产品参数

尺寸: Lx60x42mm  
材质: 6063-T5 铝合金  
表面: 氧化铝本色/喷漆 (黑色/白色)  
PC罩: 乳白/黑色/亚克力磨砂可选  
适用: 30MM软灯带/硬灯条

### Description

size: Lx60x42mm  
Material: 6063-T5  
Surface: Silver / black / white Anodized  
PC cover: Milky white/black/acrylic matte  
Apply: LED Strips and PCB 30mm

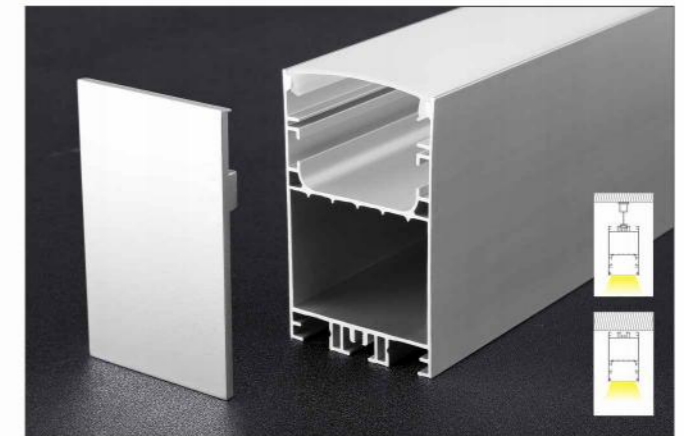
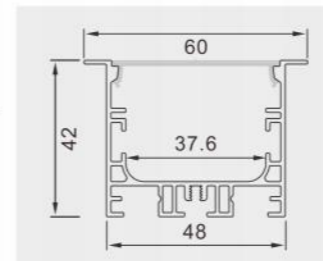

## 4878M

### 产品参数

尺寸: Lx48x78mm  
材质: 6063-T5 铝合金  
表面: 氧化铝本色/喷漆 (黑色/白色)  
PC罩: 乳白/黑色/亚克力磨砂可选  
适用: 30MM软灯带/硬灯条

### Description

size: Lx48x78mm  
Material: 6063-T5  
Surface: Silver / black / white Anodized  
PC cover: Milky white/black/acrylic matte  
Apply: LED Strips and PCB 30mm

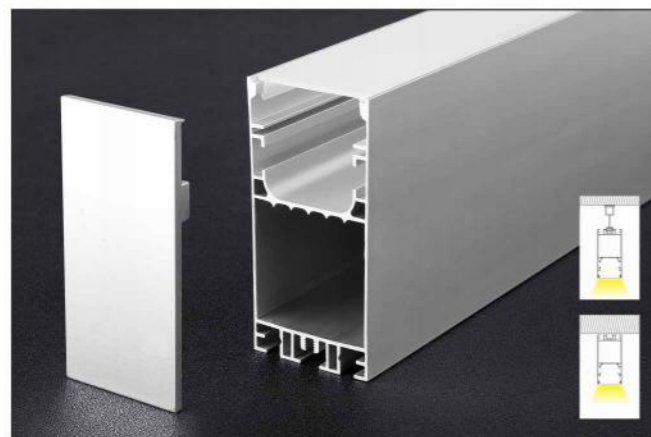
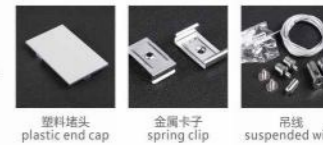
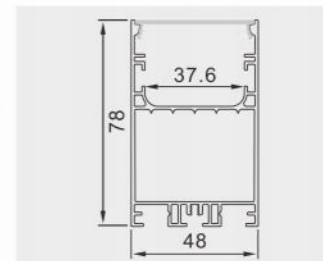

## 3878M

### 产品参数

尺寸: Lx38x78mm  
材质: 6063-T5 铝合金  
表面: 氧化铝本色/喷漆 (黑色/白色)  
PC罩: 乳白/黑色/亚克力磨砂可选  
适用: 20MM软灯带/硬灯条

### Description

size: Lx38x78mm  
Material: 6063-T5  
Surface: Silver / black / white Anodized  
PC cover: Milky white/black/acrylic matte  
Apply: LED Strips and PCB 20mm

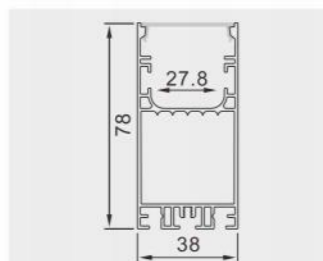

## 4842M

### 产品参数

尺寸: Lx48x42mm  
材质: 6063-T5 铝合金  
表面: 氧化铝本色/喷漆 (黑色/白色)  
PC罩: 乳白/黑色/亚克力磨砂可选  
适用: 30MM软灯带/硬灯条

### Description

size: Lx48x42mm  
Material: 6063-T5  
Surface: Silver / black / white Anodized  
PC cover: Milky white/black/acrylic matte  
Apply: LED Strips and PCB 30mm

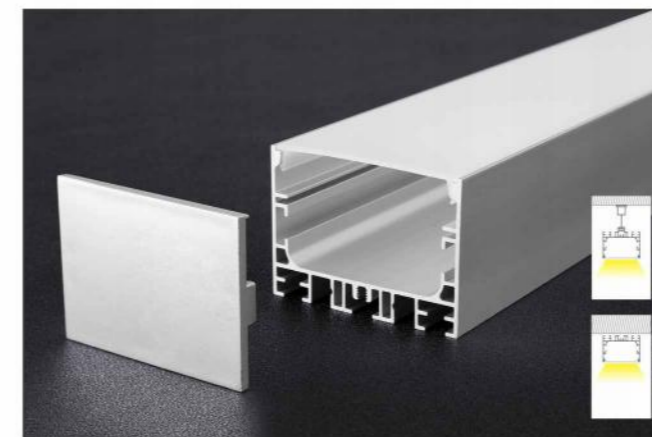
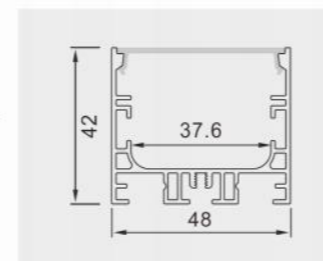

## 5842M

### 产品参数

尺寸: Lx58x42mm  
材质: 6063-T5 铝合金  
表面: 氧化铝本色/喷漆 (黑色/白色)  
PC罩: 乳白/黑色/亚克力磨砂可选  
适用: 40MM软灯带/硬灯条

### Description

size: Lx58x42mm  
Material: 6063-T5  
Surface: Silver / black / white Anodized  
PC cover: Milky white/black/acrylic matte  
Apply: LED Strips and PCB 40mm

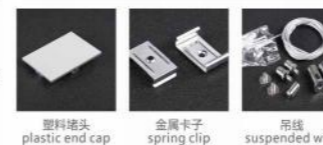
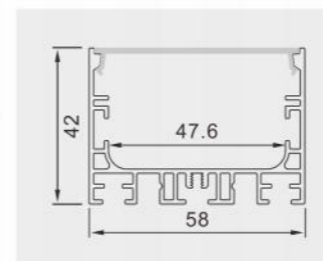

## 5842A

### 产品参数

尺寸: Lx70x42mm  
材质: 6063-T5 铝合金  
表面: 氧化铝本色/喷漆 (黑色/白色)  
PC罩: 乳白/黑色/亚克力磨砂可选  
适用: 40MM软灯带/硬灯条

### Description

size: Lx70x42mm  
Material: 6063-T5  
Surface: Silver / black / white Anodized  
PC cover: Milky white/black/acrylic matte  
Apply: LED Strips and PCB 40mm

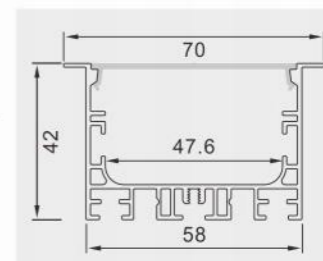

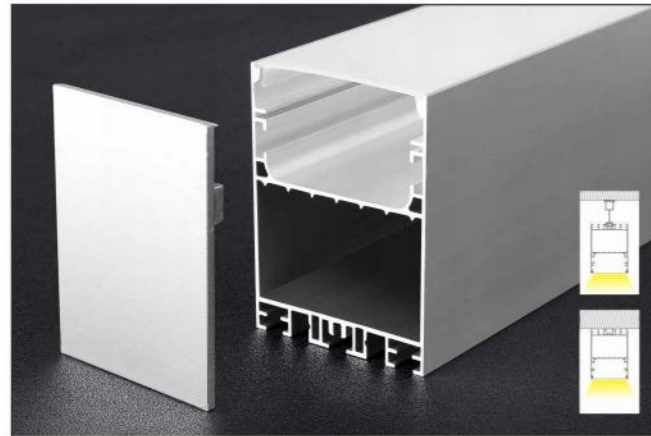

## 5878M

产品参数

尺寸: Lx58x78mm  
材质: 6063-T5 铝合金  
表面: 氧化铝本色/喷漆 (黑色/白色)  
PC罩: 乳白/黑色/亚克力磨砂可选  
适用: 40MM软灯带/硬灯条

Desciption

size: Lx58x78mm  
Material: 6063-T5  
Surface: Silver / black / white Anodized  
PC cover: Milky white/black/acrylic matte  
Apply: LED Strips and PCB 40mm

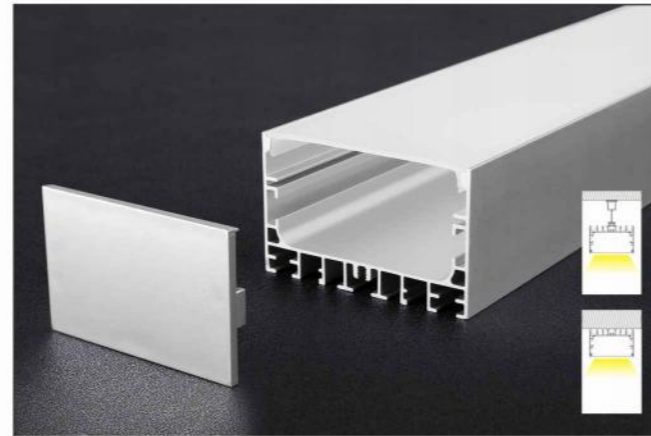
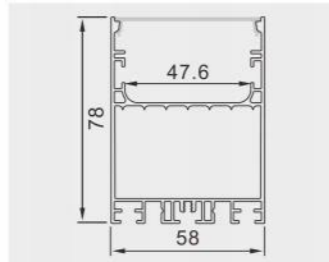

## 6842M

产品参数

尺寸: Lx68x42mm  
材质: 6063-T5 铝合金  
表面: 氧化铝本色/喷漆 (黑色/白色)  
PC罩: 乳白/黑色/亚克力磨砂可选  
适用: 50MM软灯带/硬灯条

Desciption

size: Lx68x42mm  
Material: 6063-T5  
Surface: Silver / black / white Anodized  
PC cover: Milky white/black/acrylic matte  
Apply: LED Strips and PCB 50mm

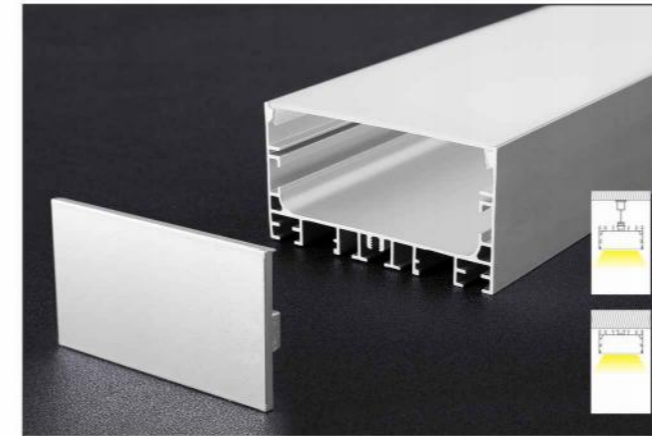
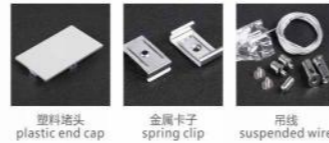
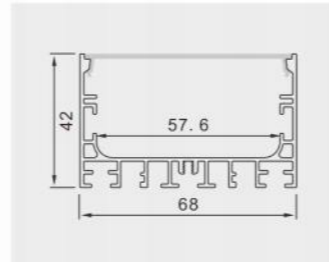

## 7842M

产品参数

尺寸: Lx78x42mm  
材质: 6063-T5 铝合金  
表面: 氧化铝本色/喷漆 (黑色/白色)  
PC罩: 乳白/黑色/亚克力磨砂可选  
适用: 60MM软灯带/硬灯条

Desciption

size: Lx78x42mm  
Material: 6063-T5  
Surface: Silver / black / white Anodized  
PC cover: Milky white/black/acrylic matte  
Apply: LED Strips and PCB 60mm

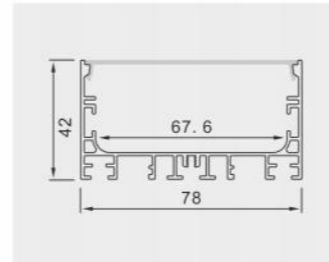

## 7842A

产品参数

尺寸: Lx90x42mm  
材质: 6063-T5 铝合金  
表面: 氧化铝本色/喷漆 (黑色/白色)  
PC罩: 乳白/黑色/亚克力磨砂可选  
适用: 60MM软灯带/硬灯条

Desciption

size: Lx90x42mm  
Material: 6063-T5  
Surface: Silver / black / white Anodized  
PC cover: Milky white/black/acrylic matte  
Apply: LED Strips and PCB 60mm

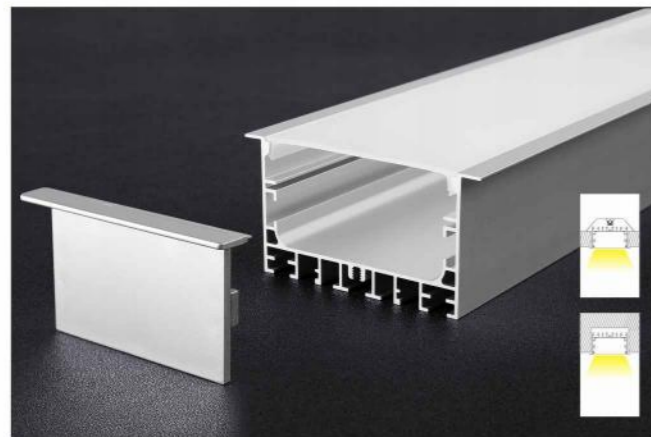
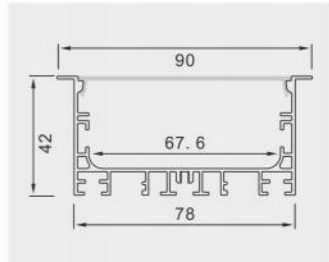

## 6842A

产品参数

尺寸: Lx80x42mm  
材质: 6063-T5 铝合金  
表面: 氧化铝本色/喷漆 (黑色/白色)  
PC罩: 乳白/黑色/亚克力磨砂可选  
适用: 50MM软灯带/硬灯条

Desciption

size: Lx80x42mm  
Material: 6063-T5  
Surface: Silver / black / white Anodized  
PC cover: Milky white/black/acrylic matte  
Apply: LED Strips and PCB 50mm

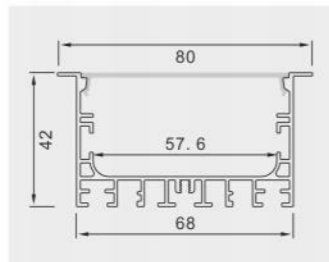

## 6878M

产品参数

尺寸: Lx68x78mm  
材质: 6063-T5 铝合金  
表面: 氧化铝本色/喷漆 (黑色/白色)  
PC罩: 乳白/黑色/亚克力磨砂可选  
适用: 50MM软灯带/硬灯条

Desciption

size: Lx68x78mm  
Material: 6063-T5  
Surface: Silver / black / white Anodized  
PC cover: Milky white/black/acrylic matte  
Apply: LED Strips and PCB 50mm

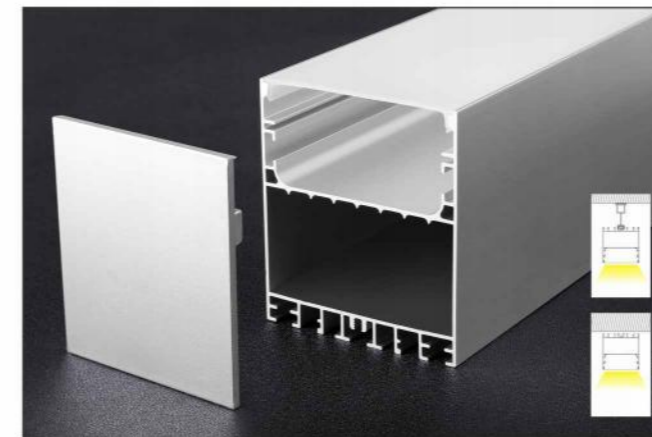
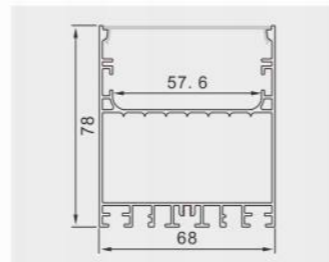

## 7878M

产品参数

尺寸: Lx78x78mm  
材质: 6063-T5 铝合金  
表面: 氧化铝本色/喷漆 (黑色/白色)  
PC罩: 乳白/黑色/亚克力磨砂可选  
适用: 60MM软灯带/硬灯条

Desciption

size: Lx78x78mm  
Material: 6063-T5  
Surface: Silver / black / white Anodized  
PC cover: Milky white/black/acrylic matte  
Apply: LED Strips and PCB 60mm

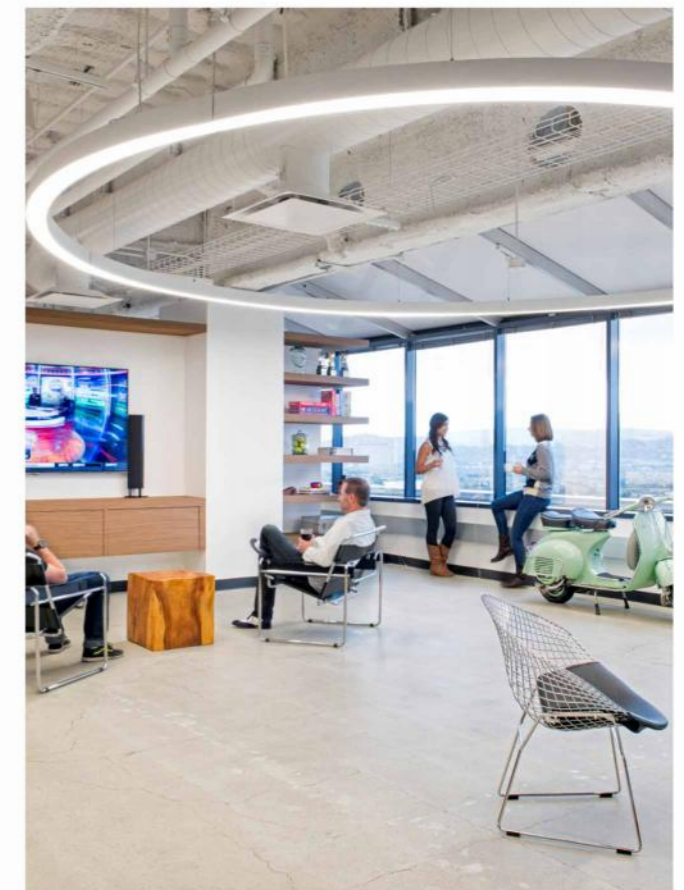
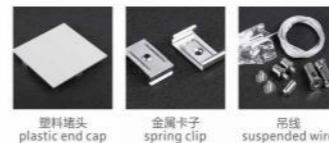
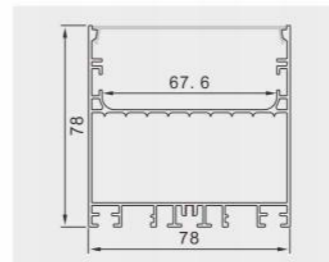



## 8842M

### 产品参数

尺寸: Lx88x42mm  
材质: 6063-T5 铝合金  
表面: 氧化铝本色/喷漆 (黑色/白色)  
PC罩: 乳白/黑色/亚克力磨砂可选  
适用: 70MM软灯带/硬灯条

### Description

size: Lx88x42mm  
Material: 6063-T5  
Surface: Silver / black / white Anodized  
PC cover: Milky white/black/acrylic matte  
Apply: LED Strips and PCB 70mm

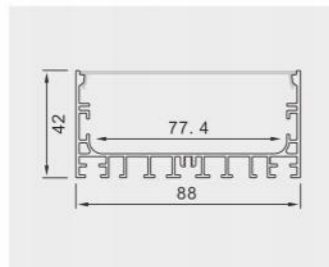

## 8842A

### 产品参数

尺寸: Lx100x42mm  
材质: 6063-T5 铝合金  
表面: 氧化铝本色/喷漆 (黑色/白色)  
PC罩: 乳白/黑色/亚克力磨砂可选  
适用: 70MM软灯带/硬灯条

### Description

size: Lx100x42mm  
Material: 6063-T5  
Surface: Silver / black / white Anodized  
PC cover: Milky white/black/acrylic matte  
Apply: LED Strips and PCB 70mm

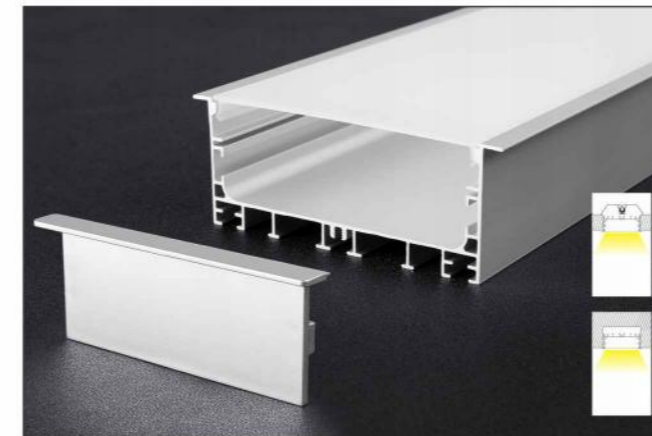
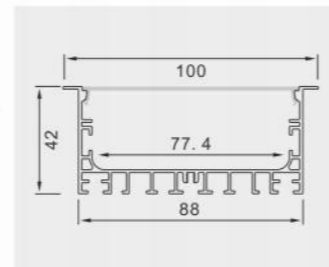

## 9842A

### 产品参数

尺寸: Lx110x42mm  
材质: 6063-T5 铝合金  
表面: 氧化铝本色/喷漆 (黑色/白色)  
PC罩: 乳白/黑色/亚克力磨砂可选  
适用: 80MM软灯带/硬灯条

### Description

size: Lx110x42mm  
Material: 6063-T5  
Surface: Silver / black / white Anodized  
PC cover: Milky white/black/acrylic matte  
Apply: LED Strips and PCB 80mm

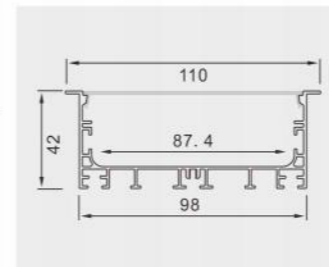

## 9878M

### 产品参数

尺寸: Lx98x78mm  
材质: 6063-T5 铝合金  
表面: 氧化铝本色/喷漆 (黑色/白色)  
PC罩: 乳白/黑色/亚克力磨砂可选  
适用: 80MM软灯带/硬灯条

### Description

size: Lx98x78mm  
Material: 6063-T5  
Surface: Silver / black / white Anodized  
PC cover: Milky white/black/acrylic matte  
Apply: LED Strips and PCB 80mm

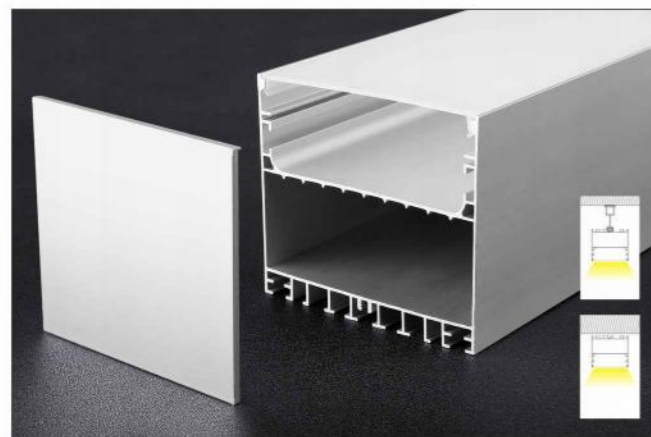
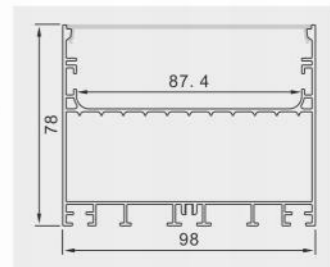

## 8878M

### 产品参数

尺寸: Lx88x78mm  
材质: 6063-T5 铝合金  
表面: 氧化铝本色/喷漆 (黑色/白色)  
PC罩: 乳白/黑色/亚克力磨砂可选  
适用: 70MM软灯带/硬灯条

### Description

size: Lx88x78mm  
Material: 6063-T5  
Surface: Silver / black / white Anodized  
PC cover: Milky white/black/acrylic matte  
Apply: LED Strips and PCB 70mm

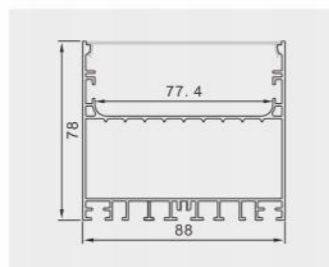

## 9842M

### 产品参数

尺寸: Lx98x42mm  
材质: 6063-T5 铝合金  
表面: 氧化铝本色/喷漆 (黑色/白色)  
PC罩: 乳白/黑色/亚克力磨砂可选  
适用: 80MM软灯带/硬灯条

### Description

size: Lx98x42mm  
Material: 6063-T5  
Surface: Silver / black / white Anodized  
PC cover: Milky white/black/acrylic matte  
Apply: LED Strips and PCB 80mm

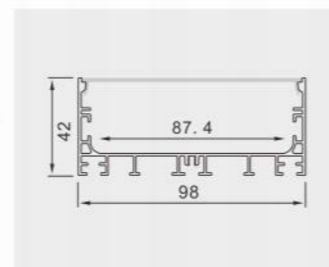

## 11842M

### 产品参数

尺寸: Lx118x42mm  
材质: 6063-T5 铝合金  
表面: 氧化铝本色/喷漆 (黑色/白色)  
PC罩: 乳白/黑色/亚克力磨砂可选  
适用: 100MM软灯带/硬灯条

### Description

size: Lx118x42mm  
Material: 6063-T5  
Surface: Silver / black / white Anodized  
PC cover: Milky white/black/acrylic matte  
Apply: LED Strips and PCB 100mm

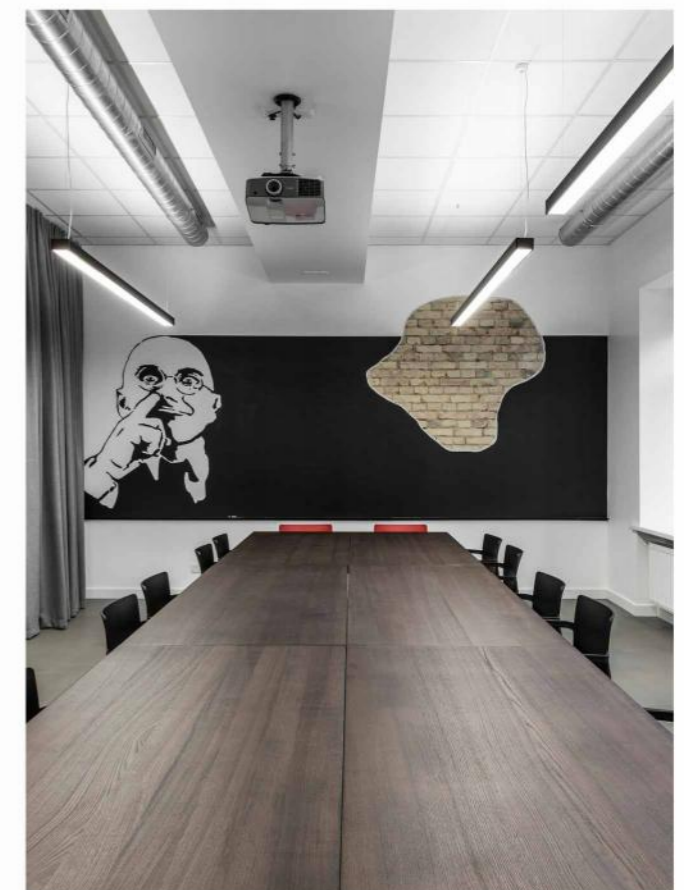
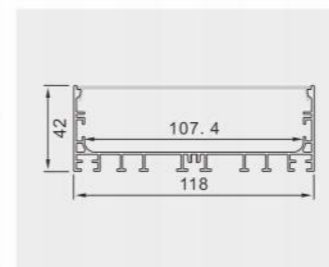





## 11842A

### 产品参数

尺寸: Lx130x42mm  
材质: 6063-T5 铝合金  
表面: 氧化铝本色/喷漆 (黑色/白色)  
PC罩: 乳白/黑色/亚克力磨砂可选  
适用: 100MM软灯带/硬灯条

### Description

size: Lx130x42mm  
Material: 6063-T5  
Surface: Silver / black / white Anodized  
PC cover: Milky white/black/acrylic matte  
Apply: LED Strips and PCB 100mm

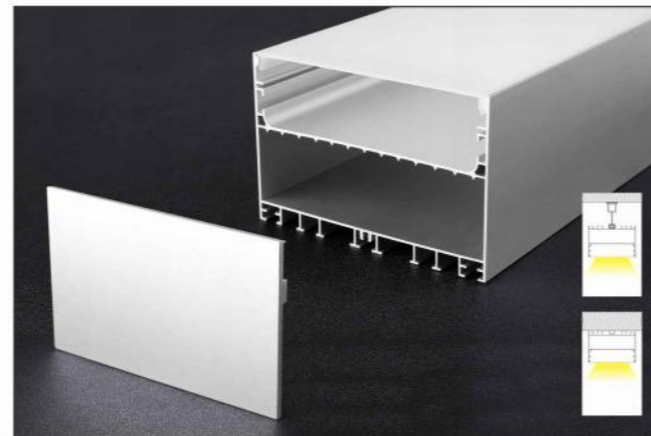
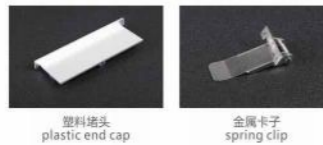
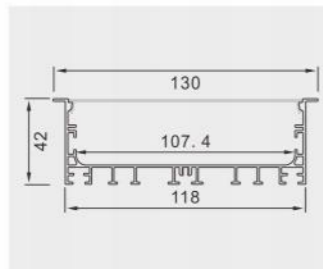

## 11878M

### 产品参数

尺寸: Lx118x78mm  
材质: 6063-T5 铝合金  
表面: 氧化铝本色/喷漆 (黑色/白色)  
PC罩: 乳白/黑色/亚克力磨砂可选  
适用: 100MM软灯带/硬灯条

### Description

size: Lx118x78mm  
Material: 6063-T5  
Surface: Silver / black / white Anodized  
PC cover: Milky white/black/acrylic matte  
Apply: LED Strips and PCB 100mm

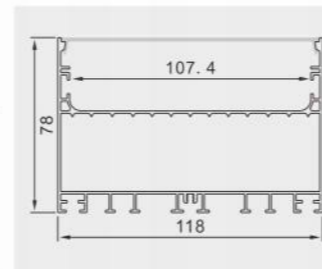

## 14878M

### 产品参数

尺寸: Lx148x78mm  
材质: 6063-T5 铝合金  
表面: 氧化铝本色/喷漆 (黑色/白色)  
PC罩: 乳白/黑色/亚克力磨砂可选  
适用: 120MM软灯带/硬灯条

### Description

size: Lx148x78mm  
Material: 6063-T5  
Surface: Silver / black / white Anodized  
PC cover: Milky white/black/acrylic matte  
Apply: LED Strips and PCB 120mm

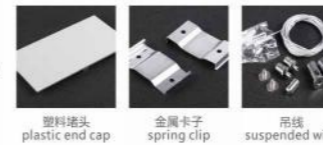
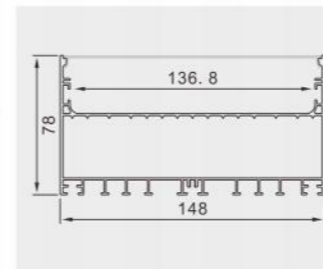

## 17842M

### 产品参数

尺寸: Lx178x42mm  
材质: 6063-T5 铝合金  
表面: 氧化铝本色/喷漆 (黑色/白色)  
PC罩: 乳白/黑色/亚克力磨砂可选  
适用: 150MM软灯带/硬灯条

### Description

size: Lx178x42mm  
Material: 6063-T5  
Surface: Silver / black / white Anodized  
PC cover: Milky white/black/acrylic matte  
Apply: LED Strips and PCB 150mm

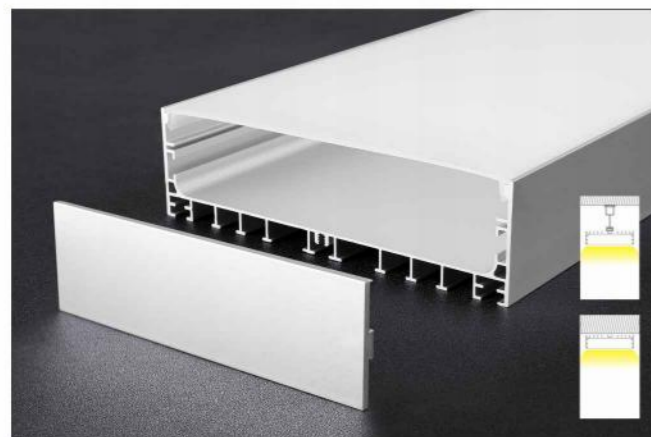
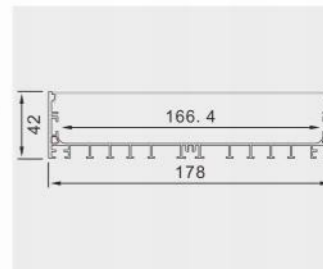

## 14842M

### 产品参数

尺寸: Lx148x42mm  
材质: 6063-T5 铝合金  
表面: 氧化铝本色/喷漆 (黑色/白色)  
PC罩: 乳白/黑色/亚克力磨砂可选  
适用: 120MM软灯带/硬灯条

### Description

size: Lx148x42mm  
Material: 6063-T5  
Surface: Silver / black / white Anodized  
PC cover: Milky white/black/acrylic matte  
Apply: LED Strips and PCB 120mm

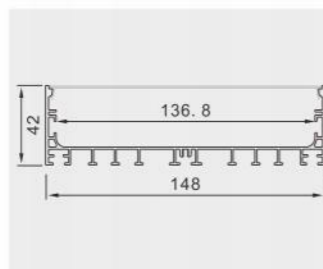

## 14842A

### 产品参数

尺寸: Lx160x42mm  
材质: 6063-T5 铝合金  
表面: 氧化铝本色/喷漆 (黑色/白色)  
PC罩: 乳白/黑色/亚克力磨砂可选  
适用: 120MM软灯带/硬灯条

### Description

size: Lx160x42mm  
Material: 6063-T5  
Surface: Silver / black / white Anodized  
PC cover: Milky white/black/acrylic matte  
Apply: LED Strips and PCB 120mm

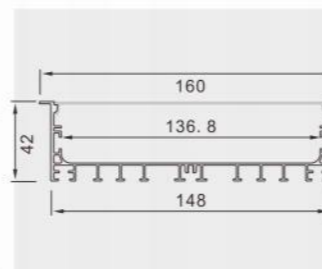

## 17842A

### 产品参数

尺寸: Lx190x42mm  
材质: 6063-T5 铝合金  
表面: 氧化铝本色/喷漆 (黑色/白色)  
PC罩: 乳白/黑色/亚克力磨砂可选  
适用: 150MM软灯带/硬灯条

### Description

size: Lx190x42mm  
Material: 6063-T5  
Surface: Silver / black / white Anodized  
PC cover: Milky white/black/acrylic matte  
Apply: LED Strips and PCB 150mm

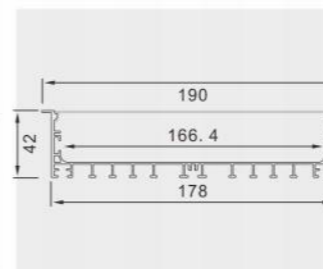

## 17878M

### 产品参数

尺寸: Lx178x78mm  
材质: 6063-T5 铝合金  
表面: 氧化铝本色/喷漆 (黑色/白色)  
PC罩: 乳白/黑色/亚克力磨砂可选  
适用: 150MM软灯带/硬灯条

### Description

size: Lx178x78mm  
Material: 6063-T5  
Surface: Silver / black / white Anodized  
PC cover: Milky white/black/acrylic matte  
Apply: LED Strips and PCB 150mm

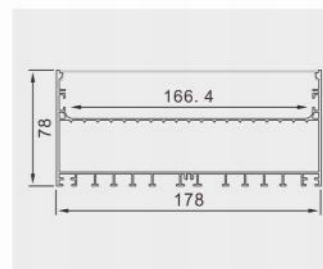

# 硬灯条 铝型材套件

»» P10-P20



2022  
NEW STYLE

**505**

产品参数  
尺寸: Lx17.4x12mm  
材质: 6063-T5 铝合金  
表面: 氧化铝本色/喷漆 (黑色/白色)  
PC罩: 乳白/黑色/亚克力磨砂可选  
适用: 12MM软灯带/硬灯条

Description  
size: Lx17.4x12mm  
Material: 6063-T5  
Surface: Silver / black / white Anodized  
PC cover: Milky white/black/acrylic matte  
Apply: LED Strips and PCB 12mm

塑料堵头 plastic end cap      金属卡子 spring clip

**508**

产品参数  
尺寸: Lx24.7x7mm  
材质: 6063-T5 铝合金  
表面: 氧化铝本色/喷漆 (黑色/白色)  
PC罩: 乳白/黑色/亚克力磨砂可选  
适用: 12MM软灯带/硬灯条

Description  
size: Lx24.7x7mm  
Material: 6063-T5  
Surface: Silver / black / white Anodized  
PC cover: Milky white/black/acrylic matte  
Apply: LED Strips and PCB 12mm

塑料堵头 plastic end cap      金属卡子 spring clip

**509**

产品参数  
尺寸: Lx17.4x7mm  
材质: 6063-T5 铝合金  
表面: 氧化铝本色/喷漆 (黑色/白色)  
PC罩: 乳白/黑色/亚克力磨砂可选  
适用: 12MM软灯带/硬灯条

Description  
size: Lx17.4x7mm  
Material: 6063-T5  
Surface: Silver / black / white Anodized  
PC cover: Milky white/black/acrylic matte  
Apply: LED Strips and PCB 12mm

塑料堵头 plastic end cap      金属卡子 spring clip

**510**

产品参数  
尺寸: Lx13.2x7mm  
材质: 6063-T5 铝合金  
表面: 氧化铝本色/喷漆 (黑色/白色)  
PC罩: 乳白/黑色/亚克力磨砂可选  
适用: 12MM软灯带/硬灯条

Description  
size: Lx13.2x7mm  
Material: 6063-T5  
Surface: Silver / black / white Anodized  
PC cover: Milky white/black/acrylic matte  
Apply: LED Strips and PCB 12mm

塑料堵头 plastic end cap      金属卡子 spring clip

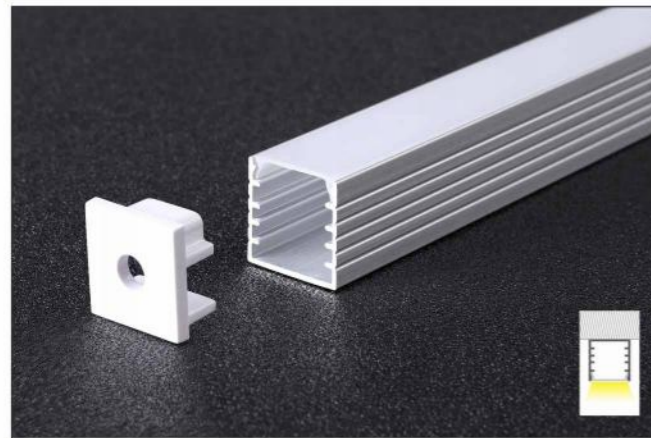

## 524

### 产品参数

尺寸: Lx14.5x14.5mm  
材质: 6063-T5 铝合金  
表面: 氧化铝本色/喷漆 (黑色/白色)  
PC罩: 乳白/黑色/亚克力磨砂可选  
适用: 12MM软灯带/硬灯条

### Description

size: Lx14.5x14.5mm  
Material: 6063-T5  
Surface: Silver / black / white Anodized  
PC cover: Milky white/black/acrylic matte  
Apply: LED Strips and PCB 12mm

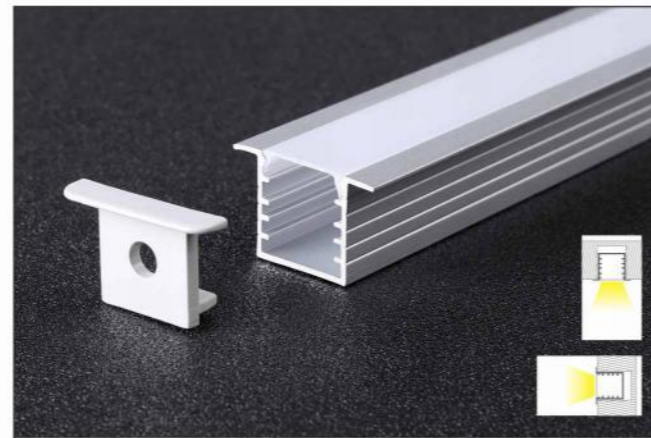
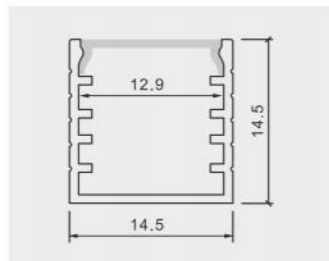

## 524A

### 产品参数

尺寸: Lx23x14.5mm  
材质: 6063-T5 铝合金  
表面: 氧化铝本色/喷漆 (黑色/白色)  
PC罩: 乳白/黑色/亚克力磨砂可选  
适用: 12MM软灯带/硬灯条

### Description

size: Lx23x14.5mm  
Material: 6063-T5  
Surface: Silver / black / white Anodized  
PC cover: Milky white/black/acrylic matte  
Apply: LED Strips and PCB 12mm

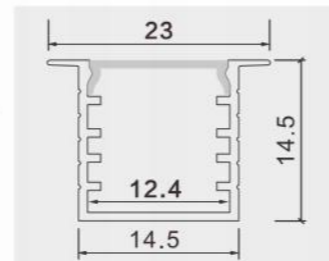

## 610

### 产品参数

尺寸: Lx15.5x5.9mm  
材质: 6063-T5 铝合金  
表面: 氧化铝本色/喷漆 (黑色/白色)  
PC罩: 乳白/黑色/亚克力磨砂可选  
适用: 12MM软灯带/硬灯条

### Description

size: Lx15.5x5.9mm  
Material: 6063-T5  
Surface: Silver / black / white Anodized  
PC cover: Milky white/black/acrylic matte  
Apply: LED Strips and PCB 12mm

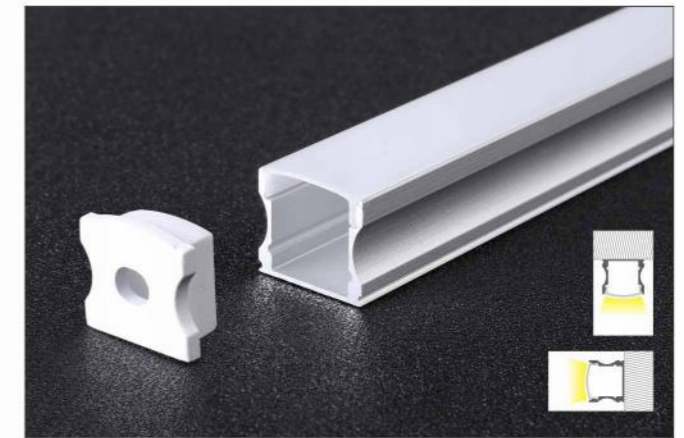
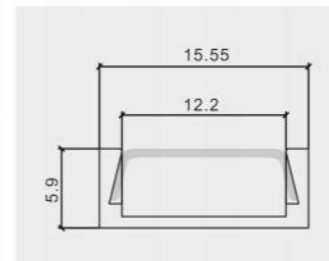

## 613

### 产品参数

尺寸: Lx17.2x14.4mm  
材质: 6063-T5 铝合金  
表面: 氧化铝本色/喷漆 (黑色/白色)  
PC罩: 乳白/黑色/亚克力磨砂可选  
适用: 12MM软灯带/硬灯条

### Description

size: Lx17.2x14.4mm  
Material: 6063-T5  
Surface: Silver / black / white Anodized  
PC cover: Milky white/black/acrylic matte  
Apply: LED Strips and PCB 12mm

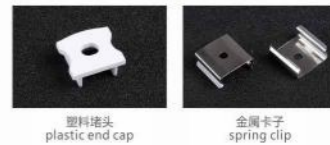
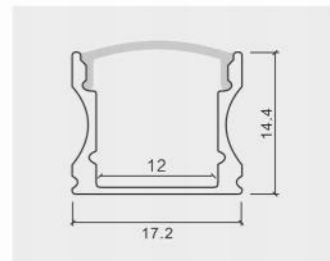

## 601

### 产品参数

尺寸: Lx15.8x15.8mm  
材质: 6063-T5 铝合金  
表面: 氧化铝本色/喷漆 (黑色/白色)  
PC罩: 乳白/黑色/亚克力磨砂可选  
适用: 10MM软灯带/硬灯条

### Description

size: Lx15.8x15.8mm  
Material: 6063-T5  
Surface: Silver / black / white Anodized  
PC cover: Milky white/black/acrylic matte  
Apply: LED Strips and PCB 10mm

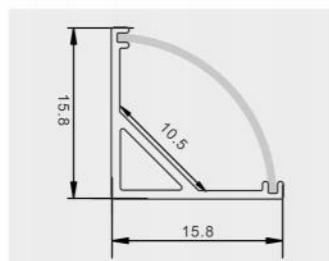

## 605

### 产品参数

尺寸: Lx24.5x12.2mm  
材质: 6063-T5 铝合金  
表面: 氧化铝本色/喷漆 (黑色/白色)  
PC罩: 乳白/黑色/亚克力磨砂可选  
适用: 12MM软灯带/硬灯条

### Description

size: Lx24.5x12.2mm  
Material: 6063-T5  
Surface: Silver / black / white Anodized  
PC cover: Milky white/black/acrylic matte  
Apply: LED Strips and PCB 12mm

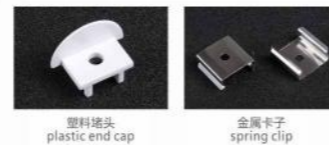
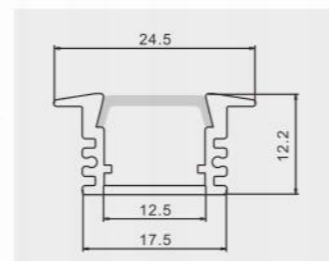

## 613B

### 产品参数

尺寸: Lx24x14.2mm  
材质: 6063-T5 铝合金  
表面: 氧化铝本色/喷漆 (黑色/白色)  
PC罩: 乳白/黑色/亚克力磨砂可选  
适用: 12MM软灯带/硬灯条

### Description

size: Lx24x14.2mm  
Material: 6063-T5  
Surface: Silver / black / white Anodized  
PC cover: Milky white/black/acrylic matte  
Apply: LED Strips and PCB 12mm

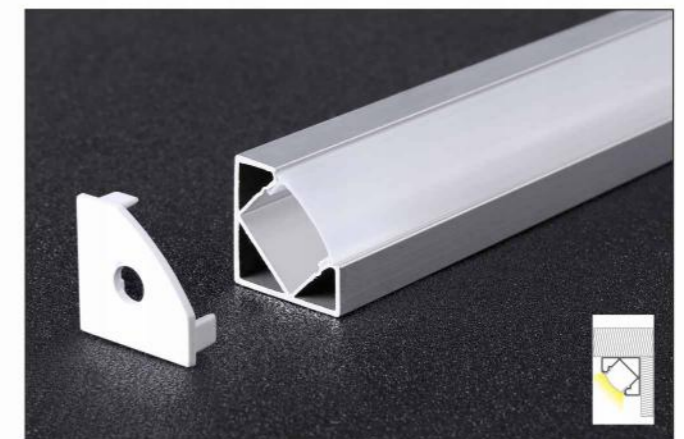
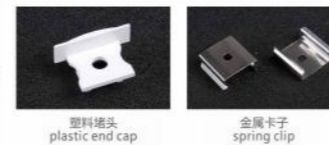
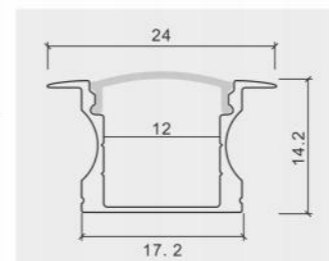

## 614

### 产品参数

尺寸: Lx19x19mm  
材质: 6063-T5 铝合金  
表面: 氧化铝本色/喷漆 (黑色/白色)  
PC罩: 乳白/黑色/亚克力磨砂可选  
适用: 12MM软灯带/硬灯条

### Description

size: Lx19x19mm  
Material: 6063-T5  
Surface: Silver / black / white Anodized  
PC cover: Milky white/black/acrylic matte  
Apply: LED Strips and PCB 12mm

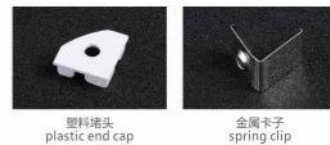
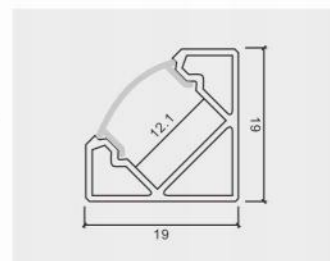

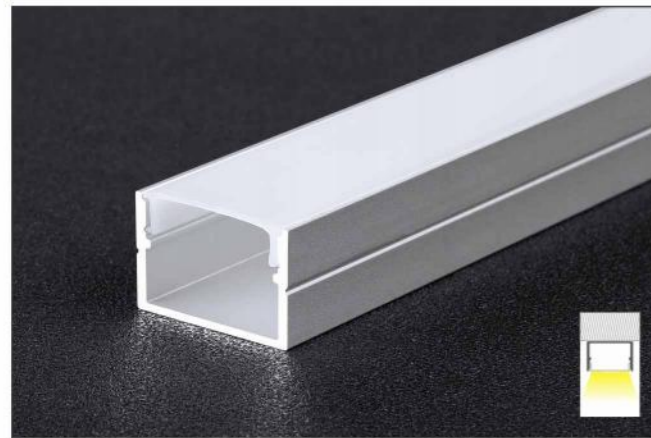

## 616

### 产品参数

尺寸: Lx20x13mm  
材质: 6063-T5 铝合金  
表面: 氧化铝本色/喷漆 (黑色/白色)  
PC罩: 乳白/黑色/亚克力磨砂可选  
适用: 17.6MM软灯带/硬灯条

### Description

size: Lx20x13mm  
Material: 6063-T5  
Surface: Silver / black / white Anodized  
PC cover: Milky white/black/acrylic matte  
Apply: LED Strips and PCB 17.6mm

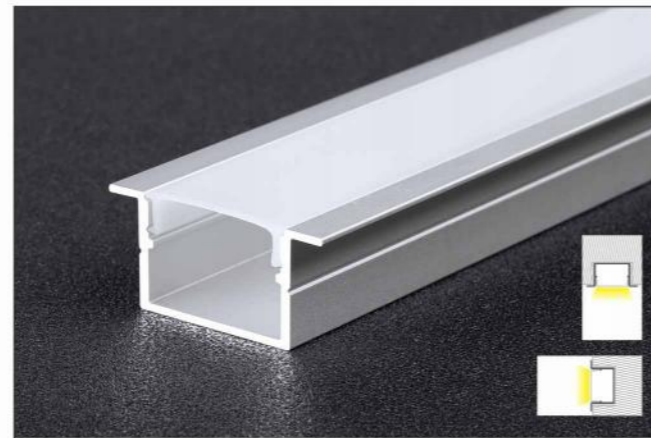
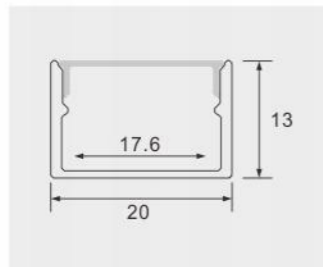

## 616A

### 产品参数

尺寸: Lx28x13mm  
材质: 6063-T5 铝合金  
表面: 氧化铝本色/喷漆 (黑色/白色)  
PC罩: 乳白/黑色/亚克力磨砂可选  
适用: 17.6MM软灯带/硬灯条

### Description

size: Lx28x13mm  
Material: 6063-T5  
Surface: Silver / black / white Anodized  
PC cover: Milky white/black/acrylic matte  
Apply: LED Strips and PCB 17.6mm

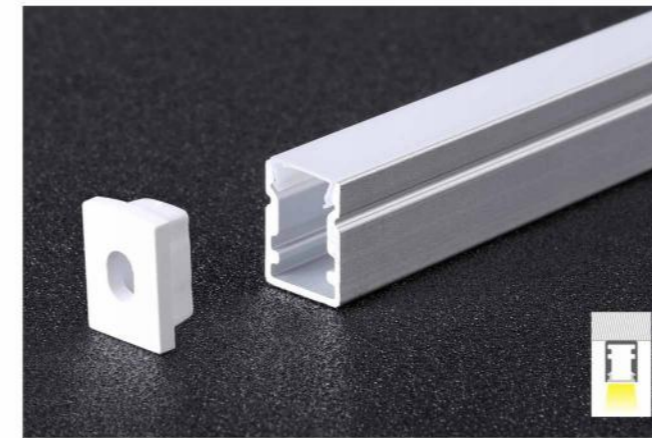
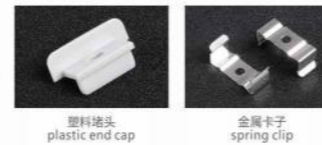
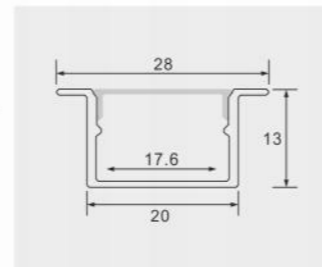

## 624

### 产品参数

尺寸: Lx10x13mm  
材质: 6063-T5 铝合金  
表面: 氧化铝本色/喷漆 (黑色/白色)  
PC罩: 乳白/黑色/亚克力磨砂可选  
适用: 8MM软灯带/硬灯条

### Description

size: Lx10x13mm  
Material: 6063-T5  
Surface: Silver / black / white Anodized  
PC cover: Milky white/black/acrylic matte  
Apply: LED Strips and PCB 8mm

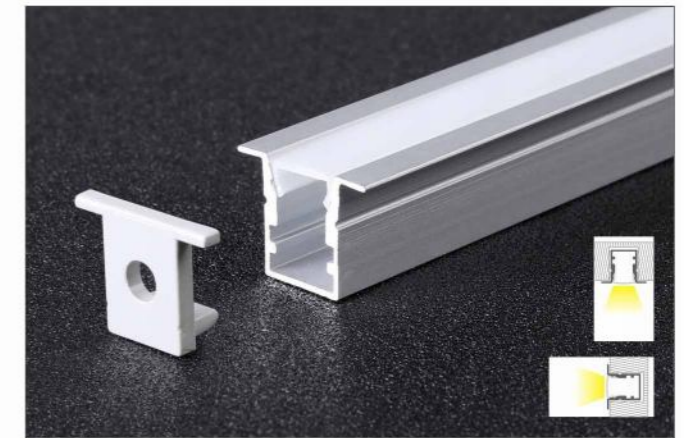
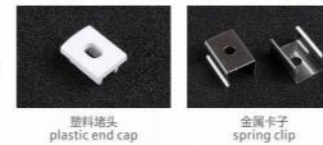
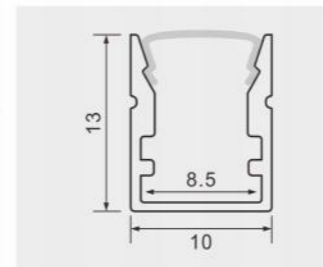

## 624A

### 产品参数

尺寸: Lx17x13mm  
材质: 6063-T5 铝合金  
表面: 氧化铝本色/喷漆 (黑色/白色)  
PC罩: 乳白/黑色/亚克力磨砂可选  
适用: 8MM软灯带/硬灯条

### Description

size: Lx17x13mm  
Material: 6063-T5  
Surface: Silver / black / white Anodized  
PC cover: Milky white/black/acrylic matte  
Apply: LED Strips and PCB 8mm

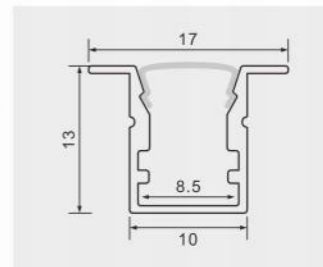

## 618

### 产品参数

尺寸: Lx21.7x5.7mm  
材质: 6063-T5 铝合金  
表面: 氧化铝本色/喷漆 (黑色/白色)  
PC罩: 乳白/黑色/亚克力磨砂可选  
适用: 11MM软灯带/硬灯条

### Description

size: Lx21.7x5.7mm  
Material: 6063-T5  
Surface: Silver / black / white Anodized  
PC cover: Milky white/black/acrylic matte  
Apply: LED Strips and PCB 11mm

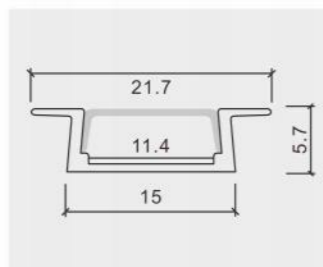

## 623

### 产品参数

尺寸: Lx20x20mm  
材质: 6063-T5 铝合金  
表面: 氧化铝本色/喷漆 (黑色/白色)  
PC罩: 乳白/黑色/亚克力磨砂可选  
适用: 16MM软灯带/硬灯条

### Description

size: Lx20x20mm  
Material: 6063-T5  
Surface: Silver / black / white Anodized  
PC cover: Milky white/black/acrylic matte  
Apply: LED Strips and PCB 16mm

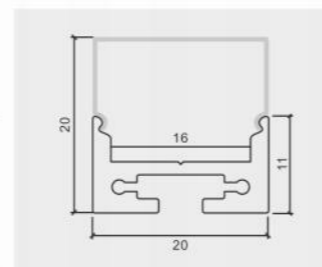

## MA-1

### 产品参数

尺寸: Lx18.5x10.5mm  
材质: 6063-T5 铝合金  
表面: 氧化铝本色/喷漆 (黑色/白色)  
PC罩: 乳白/黑色/亚克力磨砂可选  
适用: 12MM软灯带/硬灯条

### Description

size: Lx18.5x10.5mm  
Material: 6063-T5  
Surface: Silver / black / white Anodized  
PC cover: Milky white/black/acrylic matte  
Apply: LED Strips and PCB 12mm

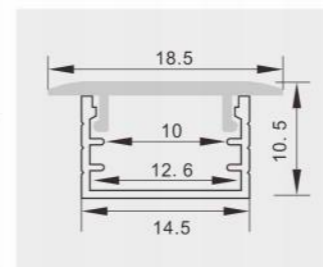

## 1409A

### 产品参数

尺寸: Lx18.6x8.5mm  
材质: 6063-T5 铝合金  
表面: 氧化铝本色/喷漆 (黑色/白色)  
PC罩: 乳白/黑色/亚克力磨砂可选  
适用: 12MM软灯带/硬灯条

### Description

size: Lx18.6x8.5mm  
Material: 6063-T5  
Surface: Silver / black / white Anodized  
PC cover: Milky white/black/acrylic matte  
Apply: LED Strips and PCB 12mm

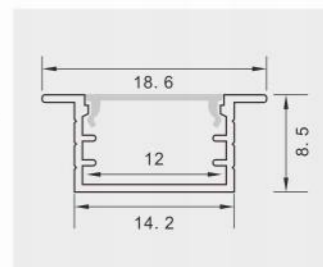



## 1409M

### 产品参数

尺寸: Lx14.2x8.5mm  
材质: 6063-T5 铝合金  
表面: 氧化铝本色/喷漆 (黑色/白色)  
PC罩: 乳白/黑色/亚克力磨砂可选  
适用: 12MM软灯带/硬灯条

### Description

size: Lx14.2x8.5mm  
Material: 6063-T5  
Surface: Silver / black / white Anodized  
PC cover: Milky white/black/acrylic matte  
Apply: LED Strips and PCB 12mm

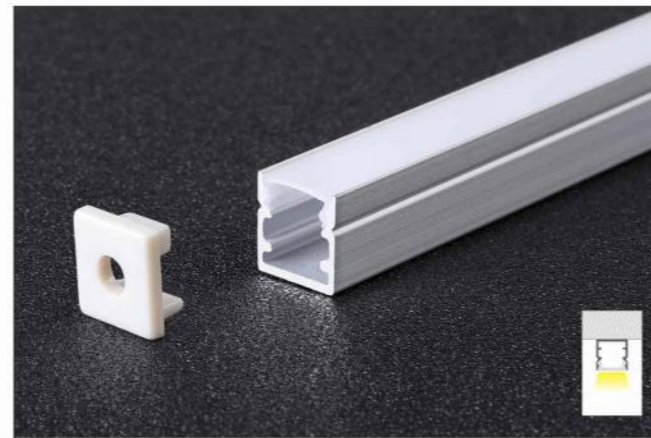
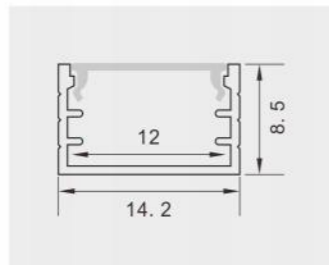

## 1010M

### 产品参数

尺寸: Lx10x10mm  
材质: 6063-T5 铝合金  
表面: 氧化铝本色/喷漆 (黑色/白色)  
PC罩: 乳白/黑色/亚克力磨砂可选  
适用: 8MM软灯带/硬灯条

### Description

size: Lx10x10mm  
Material: 6063-T5  
Surface: Silver / black / white Anodized  
PC cover: Milky white/black/acrylic matte  
Apply: LED Strips and PCB 8mm

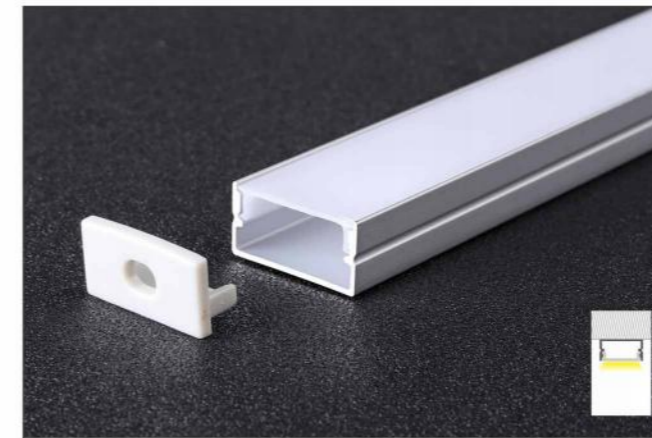
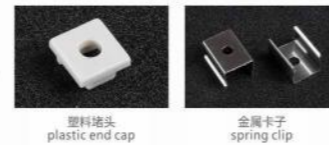
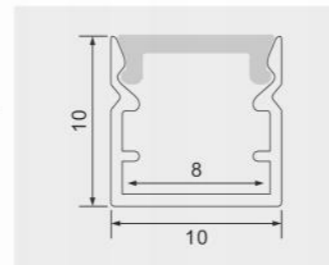

## 2010M

### 产品参数

尺寸: Lx20x10mm  
材质: 6063-T5 铝合金  
表面: 氧化铝本色/喷漆 (黑色/白色)  
PC罩: 乳白/黑色/亚克力磨砂可选  
适用: 18MM软灯带/硬灯条

### Description

size: Lx20x10mm  
Material: 6063-T5  
Surface: Silver / black / white Anodized  
PC cover: Milky white/black/acrylic matte  
Apply: LED Strips and PCB 18mm

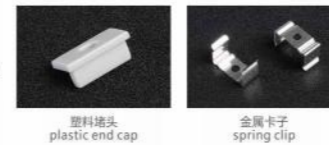
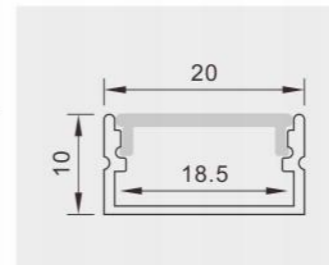

## 2010A

### 产品参数

尺寸: Lx28x10mm  
材质: 6063-T5 铝合金  
表面: 氧化铝本色/喷漆 (黑色/白色)  
PC罩: 乳白/黑色/亚克力磨砂可选  
适用: 18MM软灯带/硬灯条

### Description

size: Lx28x10mm  
Material: 6063-T5  
Surface: Silver / black / white Anodized  
PC cover: Milky white/black/acrylic matte  
Apply: LED Strips and PCB 18mm

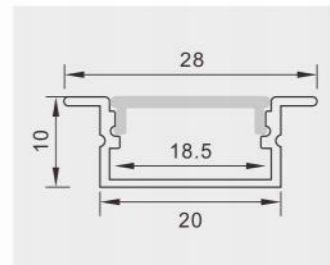

## 1010A

### 产品参数

尺寸: Lx15.6x10mm  
材质: 6063-T5 铝合金  
表面: 氧化铝本色/喷漆 (黑色/白色)  
PC罩: 乳白/黑色/亚克力磨砂可选  
适用: 8MM软灯带/硬灯条

### Description

size: Lx15.6x10mm  
Material: 6063-T5  
Surface: Silver / black / white Anodized  
PC cover: Milky white/black/acrylic matte  
Apply: LED Strips and PCB 8mm

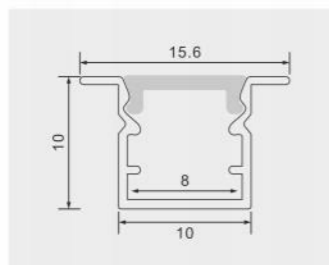

## 1313

### 产品参数

尺寸: Lx13x13mm  
材质: 6063-T5 铝合金  
表面: 氧化铝本色/喷漆 (黑色/白色)  
PC罩: 乳白/黑色/亚克力磨砂可选  
适用: 9.8MM软灯带/硬灯条

### Description

size: Lx13x13mm  
Material: 6063-T5  
Surface: Silver / black / white Anodized  
PC cover: Milky white/black/acrylic matte  
Apply: LED Strips and PCB 9.8mm

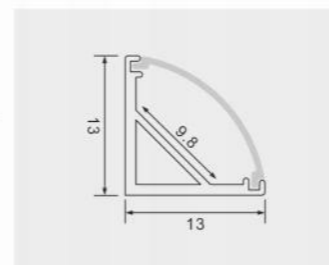

## 2010M加厚款

### 产品参数

尺寸: Lx20x10mm  
材质: 6063-T5 铝合金  
表面: 氧化铝本色/喷漆 (黑色/白色)  
PC罩: 乳白/黑色/亚克力磨砂可选  
适用: 18MM软灯带/硬灯条

### Description

size: Lx20x10mm  
Material: 6063-T5  
Surface: Silver / black / white Anodized  
PC cover: Milky white/black/acrylic matte  
Apply: LED Strips and PCB 18mm

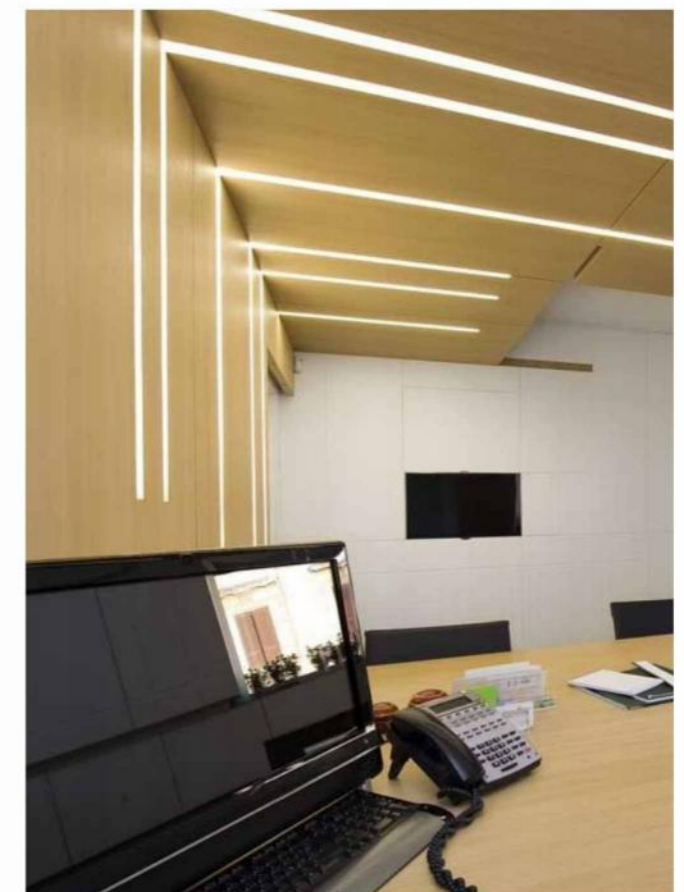
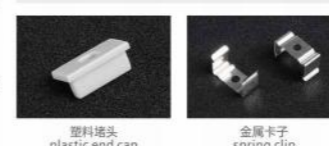
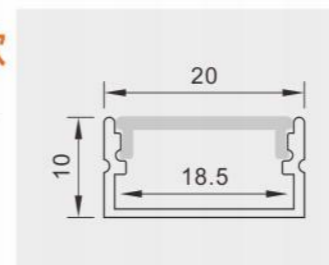



## 2010A加厚款

### 产品参数

尺寸: Lx28x10mm  
材质: 6063-T5 铝合金  
表面: 氧化铝本色/喷漆 (黑色/白色)  
PC罩: 乳白/黑色/亚克力磨砂可选  
适用: 18MM软灯带/硬灯条

### Description

size: Lx28x10mm  
Material: 6063-T5  
Surface: Silver / black / white Anodized  
PC cover: Milky white/black/acrylic matte  
Apply: LED Strips and PCB 18mm

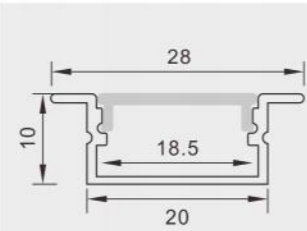

塑料堵头 plastic end cap 金属卡子 spring clip



## 2011

### 产品参数

尺寸: Lx20x20mm  
材质: 6063-T5 铝合金  
表面: 氧化铝本色/喷漆 (黑色/白色)  
PC罩: 乳白/黑色/亚克力磨砂可选  
适用: 16MM软灯带/硬灯条

### Description

size: Lx20x20mm  
Material: 6063-T5  
Surface: Silver / black / white Anodized  
PC cover: Milky white/black/acrylic matte  
Apply: LED Strips and PCB 16mm

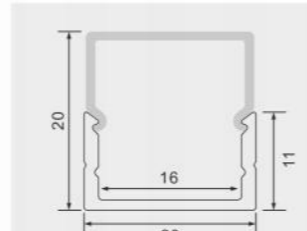

塑料堵头 plastic end cap 金属卡子 spring clip



## 2020M加厚款

### 产品参数

尺寸: Lx20x20mm  
材质: 6063-T5 铝合金  
表面: 氧化铝本色/喷漆 (黑色/白色)  
PC罩: 乳白/黑色/亚克力磨砂可选  
适用: 18MM软灯带/硬灯条

### Description

size: Lx20x20mm  
Material: 6063-T5  
Surface: Silver / black / white Anodized  
PC cover: Milky white/black/acrylic matte  
Apply: LED Strips and PCB 18mm

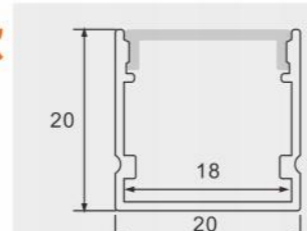

塑料堵头 plastic end cap 金属卡子 spring clip

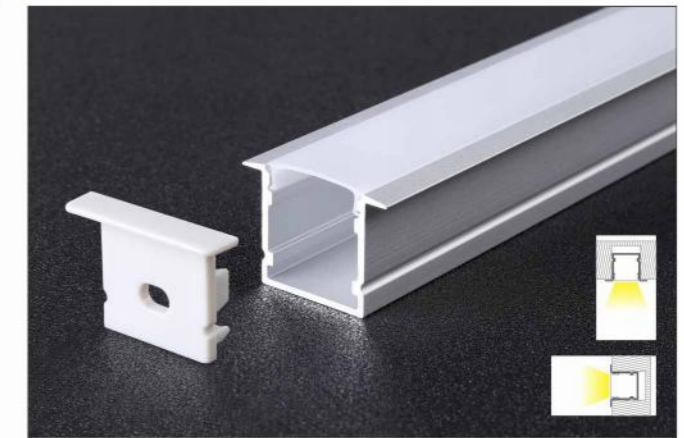

## 2020A加厚款

### 产品参数

尺寸: Lx28x20mm  
材质: 6063-T5 铝合金  
表面: 氧化铝本色/喷漆 (黑色/白色)  
PC罩: 乳白/黑色/亚克力磨砂可选  
适用: 17MM软灯带/硬灯条

### Description

size: Lx28x20mm  
Material: 6063-T5  
Surface: Silver / black / white Anodized  
PC cover: Milky white/black/acrylic matte  
Apply: LED Strips and PCB 17mm

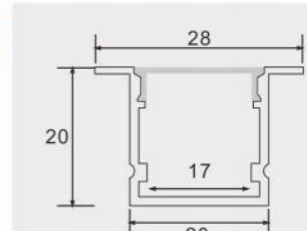

塑料堵头 plastic end cap 金属卡子 spring clip

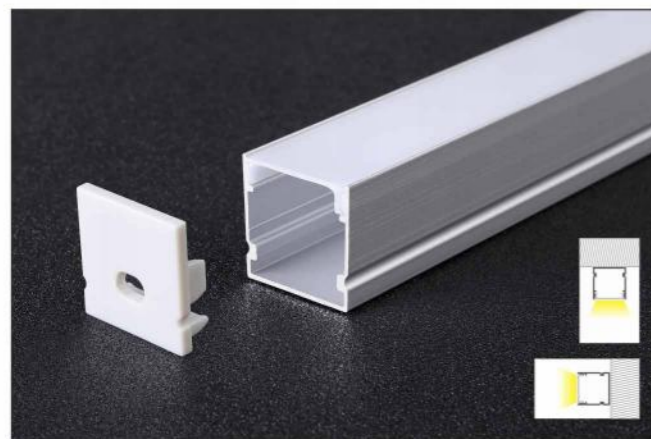

## 2020M

### 产品参数

尺寸: Lx20x20mm  
材质: 6063-T5 铝合金  
表面: 氧化铝本色/喷漆 (黑色/白色)  
PC罩: 乳白/黑色/亚克力磨砂可选  
适用: 18MM软灯带/硬灯条

### Description

size: Lx20x20mm  
Material: 6063-T5  
Surface: Silver / black / white Anodized  
PC cover: Milky white/black/acrylic matte  
Apply: LED Strips and PCB 18mm

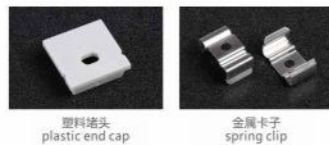
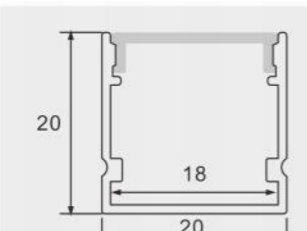

塑料堵头 plastic end cap 金属卡子 spring clip



## 2020A

### 产品参数

尺寸: Lx28x20mm  
材质: 6063-T5 铝合金  
表面: 氧化铝本色/喷漆 (黑色/白色)  
PC罩: 乳白/黑色/亚克力磨砂可选  
适用: 17MM软灯带/硬灯条

### Description

size: Lx28x20mm  
Material: 6063-T5  
Surface: Silver / black / white Anodized  
PC cover: Milky white/black/acrylic matte  
Apply: LED Strips and PCB 17mm

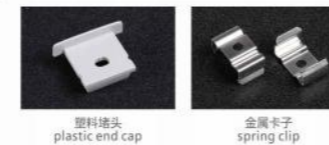
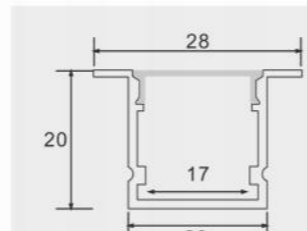

塑料堵头 plastic end cap 金属卡子 spring clip



## 3010M

### 产品参数

尺寸: Lx30x10mm  
材质: 6063-T5 铝合金  
表面: 氧化铝本色/喷漆 (黑色/白色)  
PC罩: 乳白/黑色/亚克力磨砂可选  
适用: 27MM软灯带/硬灯条

### Description

size: Lx30x10mm  
Material: 6063-T5  
Surface: Silver / black / white Anodized  
PC cover: Milky white/black/acrylic matte  
Apply: LED Strips and PCB 27mm

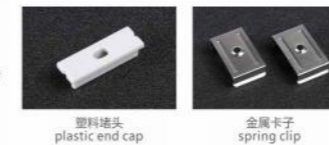
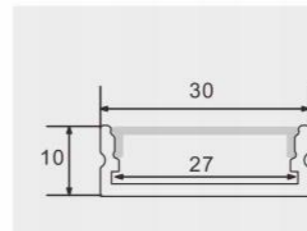

塑料堵头 plastic end cap 金属卡子 spring clip

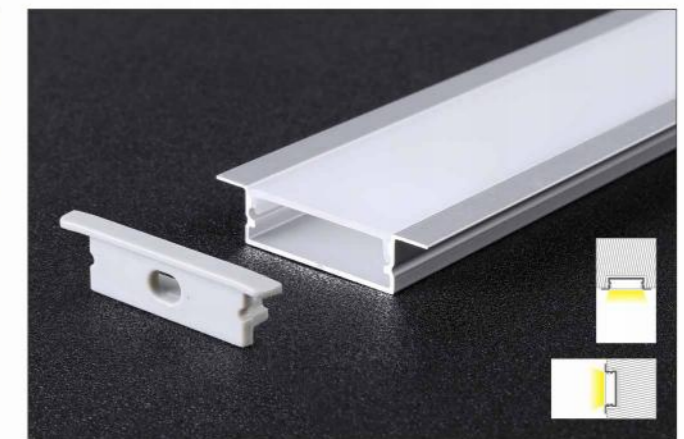

## 3010A

### 产品参数

尺寸: Lx41x10mm  
材质: 6063-T5 铝合金  
表面: 氧化铝本色/喷漆 (黑色/白色)  
PC罩: 乳白/黑色/亚克力磨砂可选  
适用: 27MM软灯带/硬灯条

### Description

size: Lx41x10mm  
Material: 6063-T5  
Surface: Silver / black / white Anodized  
PC cover: Milky white/black/acrylic matte  
Apply: LED Strips and PCB 27mm

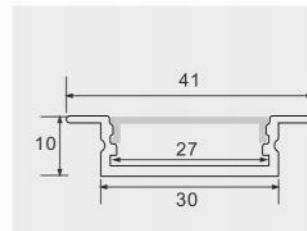

塑料堵头 plastic end cap 金属卡子 spring clip



## 3020M

### 产品参数

尺寸: Lx30x20mm  
材质: 6063-T5 铝合金  
表面: 氧化铝本色/喷漆 (黑色/白色)  
PC罩: 乳白/黑色/亚克力磨砂可选  
适用: 26MM软灯带/硬灯条

### Description

size: Lx30x20mm  
Material: 6063-T5  
Surface: Silver / black / white Anodized  
PC cover: Milky white/black/acrylic matte  
Apply: LED Strips and PCB 26mm

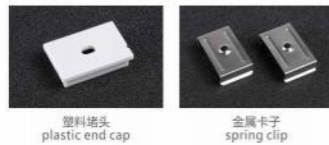
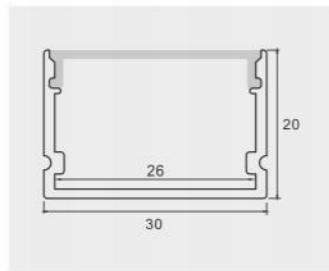

塑料堵头  
plastic end cap

金属卡子  
spring clip

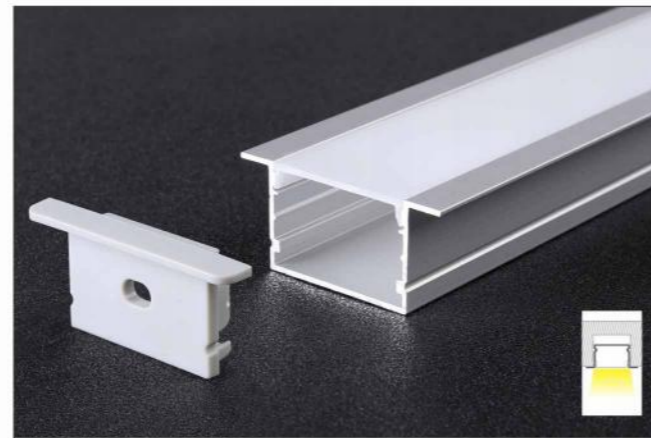

## 3020A

### 产品参数

尺寸: Lx44x20mm  
材质: 6063-T5 铝合金  
表面: 氧化铝本色/喷漆 (黑色/白色)  
PC罩: 乳白/黑色/亚克力磨砂可选  
适用: 27MM软灯带/硬灯条

### Description

size: Lx44x20mm  
Material: 6063-T5  
Surface: Silver / black / white Anodized  
PC cover: Milky white/black/acrylic matte  
Apply: LED Strips and PCB 27mm

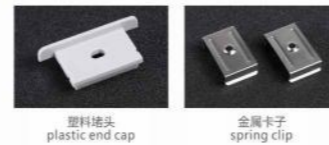
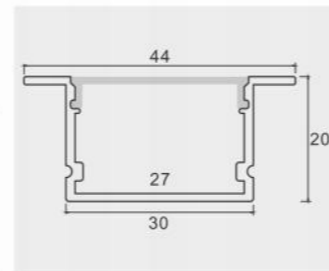

塑料堵头  
plastic end cap

金属卡子  
spring clip

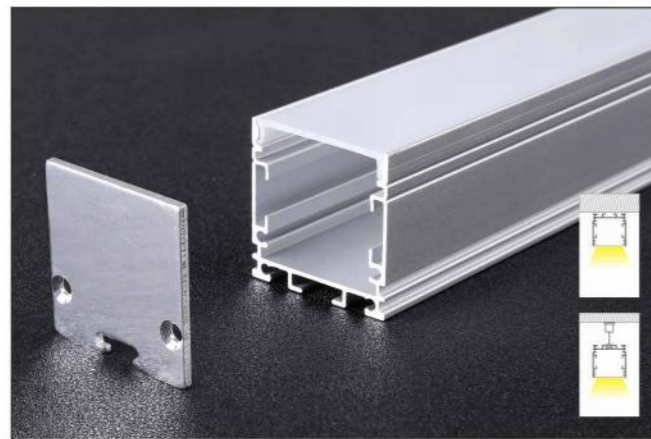

## 3030M

### 产品参数

尺寸: Lx30x30mm  
材质: 6063-T5 铝合金  
表面: 氧化铝本色/喷漆 (黑色/白色)  
PC罩: 乳白/黑色/亚克力磨砂可选  
适用: 25MM软灯带/硬灯条

### Description

size: Lx30x30mm  
Material: 6063-T5  
Surface: Silver / black / white Anodized  
PC cover: Milky white/black/acrylic matte  
Apply: LED Strips and PCB 25mm

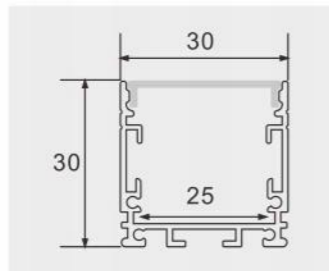

金属堵头  
metal end cap

金属卡子  
spring clip

吊线  
suspended wire

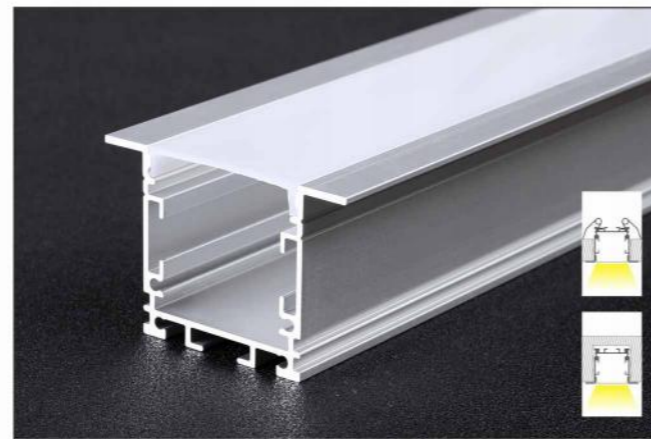

## 3030A

### 产品参数

尺寸: Lx45x30mm  
材质: 6063-T5 铝合金  
表面: 氧化铝本色/喷漆 (黑色/白色)  
PC罩: 乳白/黑色/亚克力磨砂可选  
适用: 25MM软灯带/硬灯条

### Description

size: Lx45x30mm  
Material: 6063-T5  
Surface: Silver / black / white Anodized  
PC cover: Milky white/black/acrylic matte  
Apply: LED Strips and PCB 25mm

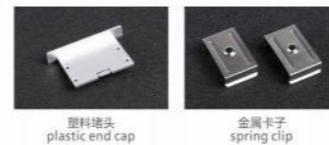
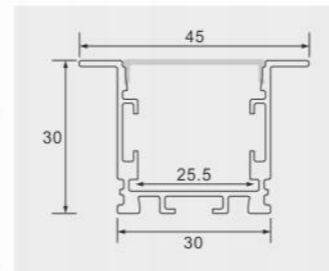

塑料堵头  
plastic end cap

金属卡子  
spring clip

# 线条灯 (办公灯系列)

## 铝型材套件

»» P21-P36



2022  
NEW STYLE



## 3535M

### 产品参数

尺寸: Lx35x35mm  
材质: 6063-T5 铝合金  
表面: 氧化铝本色/喷漆 (黑色/白色)  
PC罩: 乳白/黑色/亚克力磨砂可选  
适用: 29MM软灯带/硬灯条

### Description

size: Lx35x35mm  
Material: 6063-T5  
Surface: Silver / black / white Anodized  
PC cover: Milky white/black/acrylic matte  
Apply: LED Strips and PCB 29mm

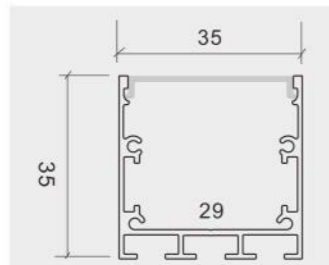

## 3535A

### 产品参数

尺寸: Lx50x35mm  
材质: 6063-T5 铝合金  
表面: 氧化铝本色/喷漆 (黑色/白色)  
PC罩: 乳白/黑色/亚克力磨砂可选  
适用: 29MM软灯带/硬灯条

### Description

size: Lx50x35mm  
Material: 6063-T5  
Surface: Silver / black / white Anodized  
PC cover: Milky white/black/acrylic matte  
Apply: LED Strips and PCB 29mm

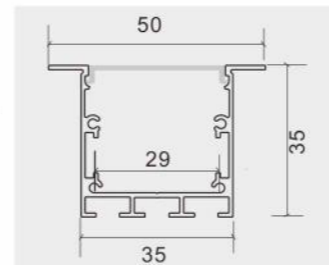

## 4035M

### 产品参数

尺寸: Lx40x35mm  
材质: 6063-T5 铝合金  
表面: 氧化铝本色/喷漆 (黑色/白色)  
PC罩: 乳白/黑色/亚克力磨砂可选  
适用: 32MM软灯带/硬灯条

### Description

size: Lx40x35mm  
Material: 6063-T5  
Surface: Silver / black / white Anodized  
PC cover: Milky white/black/acrylic matte  
Apply: LED Strips and PCB 32mm

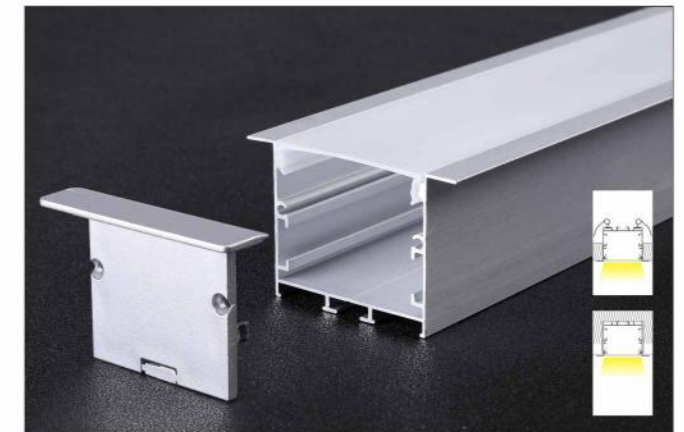
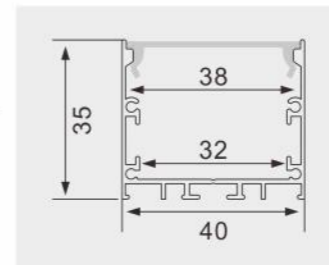

## 4035A

### 产品参数

尺寸: Lx55x35mm  
材质: 6063-T5 铝合金  
表面: 氧化铝本色/喷漆 (黑色/白色)  
PC罩: 乳白/黑色/亚克力磨砂可选  
适用: 38MM软灯带/硬灯条

### Description

size: Lx55x35mm  
Material: 6063-T5  
Surface: Silver / black / white Anodized  
PC cover: Milky white/black/acrylic matte  
Apply: LED Strips and PCB 38mm

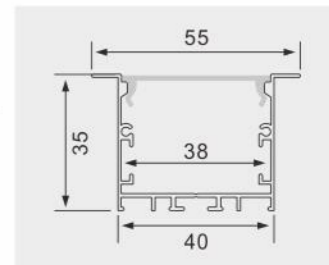

## 4020M

### 产品参数

尺寸: Lx40x20mm  
材质: 6063-T5 铝合金  
表面: 氧化铝本色/喷漆 (黑色/白色)  
PC罩: 乳白/黑色/亚克力磨砂可选  
适用: 38MM软灯带/硬灯条

### Description

size: Lx40x20mm  
Material: 6063-T5  
Surface: Silver / black / white Anodized  
PC cover: Milky white/black/acrylic matte  
Apply: LED Strips and PCB 38mm

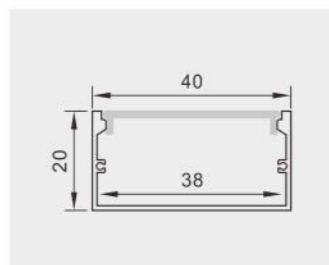

## 4020A

### 产品参数

尺寸: Lx55x20mm  
材质: 6063-T5 铝合金  
表面: 氧化铝本色/喷漆 (黑色/白色)  
PC罩: 乳白/黑色/亚克力磨砂可选  
适用: 38MM软灯带/硬灯条

### Description

size: Lx55x20mm  
Material: 6063-T5  
Surface: Silver / black / white Anodized  
PC cover: Milky white/black/acrylic matte  
Apply: LED Strips and PCB 38mm

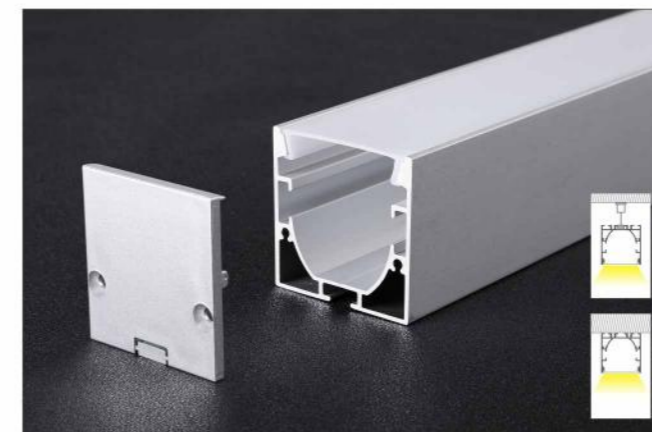
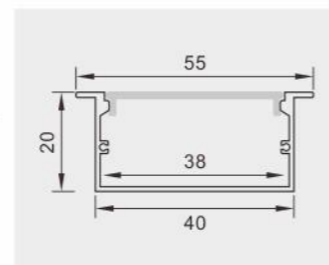

## 4040M

### 产品参数

尺寸: Lx40x40mm  
材质: 6063-T5 铝合金  
表面: 氧化铝本色/喷漆 (黑色/白色)  
PC罩: 乳白/黑色/亚克力磨砂可选  
适用: 15MM软灯带/硬灯条

### Description

size: Lx40x40mm  
Material: 6063-T5  
Surface: Silver / black / white Anodized  
PC cover: Milky white/black/acrylic matte  
Apply: LED Strips and PCB 15mm

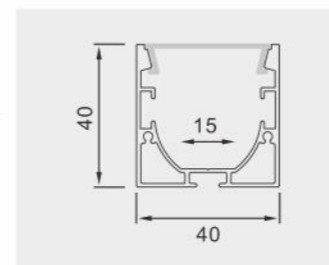

## 4040A

### 产品参数

尺寸: Lx56x40mm  
材质: 6063-T5 铝合金  
表面: 氧化铝本色/喷漆 (黑色/白色)  
PC罩: 乳白/黑色/亚克力磨砂可选  
适用: 15MM软灯带/硬灯条

### Description

size: Lx56x40mm  
Material: 6063-T5  
Surface: Silver / black / white Anodized  
PC cover: Milky white/black/acrylic matte  
Apply: LED Strips and PCB 15mm

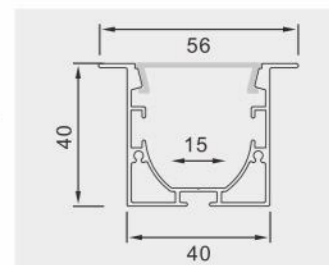





## 4075M

### 产品参数

尺寸: Lx40x75mm  
材质: 6063-T5 铝合金  
表面: 氧化铝本色/喷漆 (黑色/白色)  
PC罩: 乳白/黑色/亚克力磨砂可选  
适用: 15MM软灯带/硬灯条

### Description

size: Lx40x75mm  
Material: 6063-T5  
Surface: Silver / black / white Anodized  
PC cover: Milky white/black/acrylic matte  
Apply: LED Strips and PCB 15mm

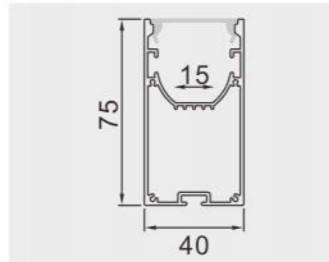

## 706

### 产品参数

尺寸: Lx49x32mm  
材质: 6063-T5 铝合金  
表面: 氧化铝本色/喷漆 (黑色/白色)  
PC罩: 乳白/黑色/亚克力磨砂可选  
适用: 45MM软灯带/硬灯条

### Description

size: Lx49x32mm  
Material: 6063-T5  
Surface: Silver / black / white Anodized  
PC cover: Milky white/black/acrylic matte  
Apply: LED Strips and PCB 45mm

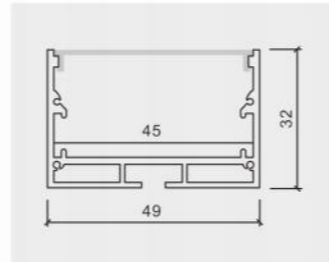

## 5035M

### 产品参数

尺寸: Lx50x35mm  
材质: 6063-T5 铝合金  
表面: 氧化铝本色/喷漆 (黑色/白色)  
PC罩: 乳白/黑色/亚克力磨砂可选  
适用: 43MM软灯带/硬灯条

### Description

size: Lx50x35mm  
Material: 6063-T5  
Surface: Silver / black / white Anodized  
PC cover: Milky white/black/acrylic matte  
Apply: LED Strips and PCB 43mm

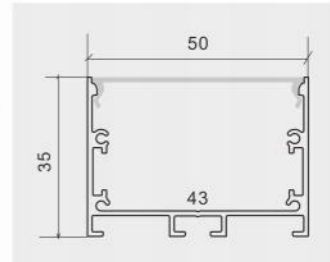

## 5020M

### 产品参数

尺寸: Lx50x20mm  
材质: 6063-T5 铝合金  
表面: 氧化铝本色/喷漆 (黑色/白色)  
PC罩: 乳白/黑色/亚克力磨砂可选  
适用: 47MM软灯带/硬灯条

### Description

size: Lx50x20mm  
Material: 6063-T5  
Surface: Silver / black / white Anodized  
PC cover: Milky white/black/acrylic matte  
Apply: LED Strips and PCB 47mm

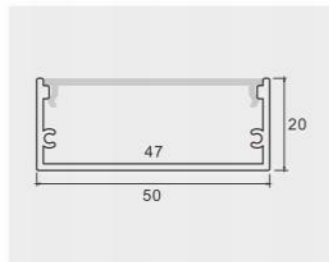

## 5020A

### 产品参数

尺寸: Lx65x20mm  
材质: 6063-T5 铝合金  
表面: 氧化铝本色/喷漆 (黑色/白色)  
PC罩: 乳白/黑色/亚克力磨砂可选  
适用: 47MM软灯带/硬灯条

### Description

size: Lx65x20mm  
Material: 6063-T5  
Surface: Silver / black / white Anodized  
PC cover: Milky white/black/acrylic matte  
Apply: LED Strips and PCB 47mm

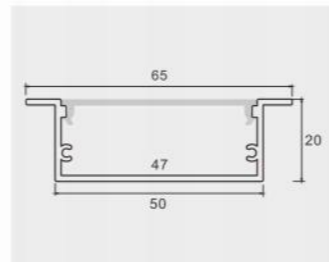

## 5035A

### 产品参数

尺寸: Lx65x35mm  
材质: 6063-T5 铝合金  
表面: 氧化铝本色/喷漆 (黑色/白色)  
PC罩: 乳白/黑色/亚克力磨砂可选  
适用: 43MM软灯带/硬灯条

### Description

size: Lx65x35mm  
Material: 6063-T5  
Surface: Silver / black / white Anodized  
PC cover: Milky white/black/acrylic matte  
Apply: LED Strips and PCB 43mm

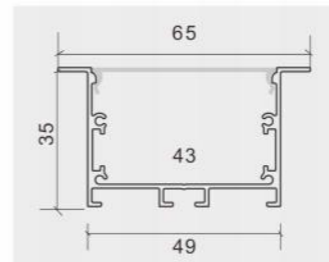

## 5035M厚款

### 产品参数

尺寸: Lx50x35mm  
材质: 6063-T5 铝合金  
表面: 氧化铝本色/喷漆 (黑色/白色)  
PC罩: 乳白/黑色/亚克力磨砂可选  
适用: 43MM软灯带/硬灯条

### Description

size: Lx50x35mm  
Material: 6063-T5  
Surface: Silver / black / white Anodized  
PC cover: Milky white/black/acrylic matte  
Apply: LED Strips and PCB 43mm

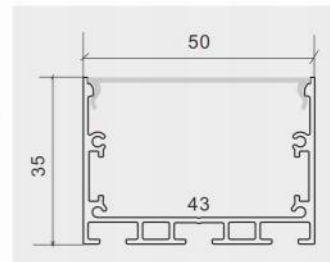



## 5035A厚款

### 产品参数

尺寸: Lx65x35mm  
材质: 6063-T5 铝合金  
表面: 氧化铝本色/喷漆 (黑色/白色)  
PC罩: 乳白/黑色/亚克力磨砂可选  
适用: 43MM软灯带/硬灯条

### Description

size: Lx65x35mm  
Material: 6063-T5  
Surface: Silver / black / white Anodized  
PC cover: Milky white/black/acrylic matte  
Apply: LED Strips and PCB 43mm

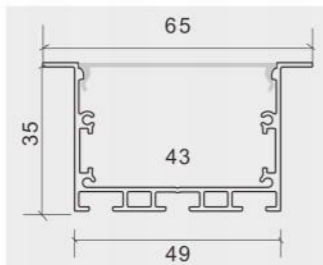

## 5040M

### 产品参数

尺寸: Lx50x40mm  
材质: 6063-T5 铝合金  
表面: 氧化铝本色/喷漆 (黑色/白色)  
PC罩: 乳白/黑色/亚克力磨砂可选  
适用: 25MM软灯带/硬灯条

### Description

size: Lx50x40mm  
Material: 6063-T5  
Surface: Silver / black / white Anodized  
PC cover: Milky white/black/acrylic matte  
Apply: LED Strips and PCB 25mm

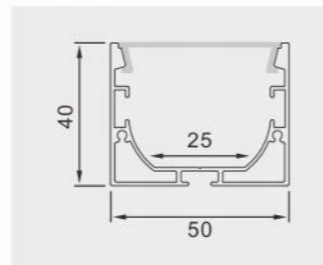

## 5075M

### 产品参数

尺寸: Lx50x75mm  
材质: 6063-T5 铝合金  
表面: 氧化铝本色/喷漆 (黑色/白色)  
PC罩: 乳白/黑色/亚克力磨砂可选  
适用: 25MM软灯带/硬灯条

### Description

size: Lx50x75mm  
Material: 6063-T5  
Surface: Silver / black / white Anodized  
PC cover: Milky white/black/acrylic matte  
Apply: LED Strips and PCB 25mm

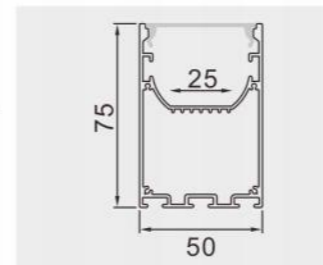

## 6035M

### 产品参数

尺寸: Lx60x35mm  
材质: 6063-T5 铝合金  
表面: 氧化铝本色/喷漆 (黑色/白色)  
PC罩: 乳白/黑色/亚克力磨砂可选  
适用: 58MM软灯带/硬灯条

### Description

size: Lx60x35mm  
Material: 6063-T5  
Surface: Silver / black / white Anodized  
PC cover: Milky white/black/acrylic matte  
Apply: LED Strips and PCB 58mm

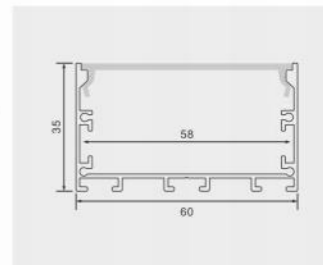

## 5040A

### 产品参数

尺寸: Lx66x40mm  
材质: 6063-T5 铝合金  
表面: 氧化铝本色/喷漆 (黑色/白色)  
PC罩: 乳白/黑色/亚克力磨砂可选  
适用: 25MM软灯带/硬灯条

### Description

size: Lx66x40mm  
Material: 6063-T5  
Surface: Silver / black / white Anodized  
PC cover: Milky white/black/acrylic matte  
Apply: LED Strips and PCB 25mm

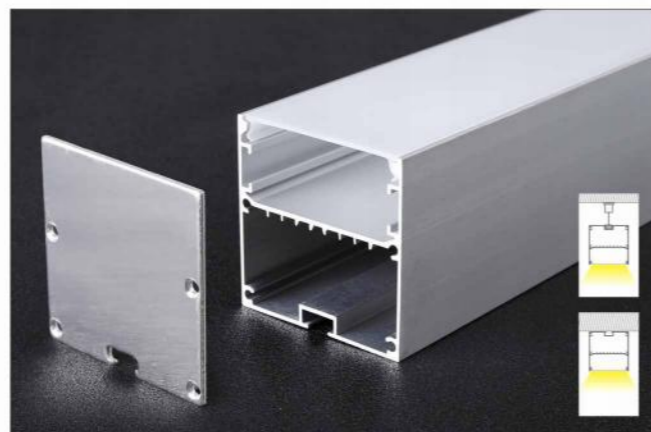
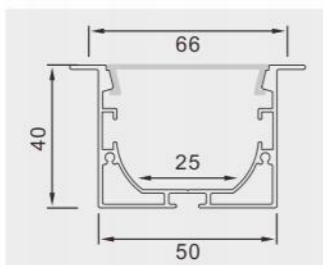

## 5050M

### 产品参数

尺寸: Lx50x50mm  
材质: 6063-T5 铝合金  
表面: 氧化铝本色/喷漆 (黑色/白色)  
PC罩: 乳白/黑色/亚克力磨砂可选  
适用: 38MM软灯带/硬灯条

### Description

size: Lx50x50mm  
Material: 6063-T5  
Surface: Silver / black / white Anodized  
PC cover: Milky white/black/acrylic matte  
Apply: LED Strips and PCB 38mm

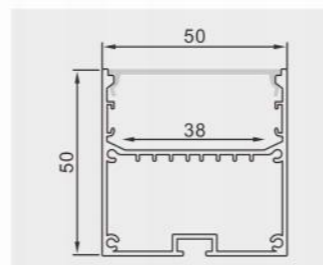

## 6035A

### 产品参数

尺寸: Lx76x35mm  
材质: 6063-T5 铝合金  
表面: 氧化铝本色/喷漆 (黑色/白色)  
PC罩: 乳白/黑色/亚克力磨砂可选  
适用: 58MM软灯带/硬灯条

### Description

size: Lx76x35mm  
Material: 6063-T5  
Surface: Silver / black / white Anodized  
PC cover: Milky white/black/acrylic matte  
Apply: LED Strips and PCB 58mm

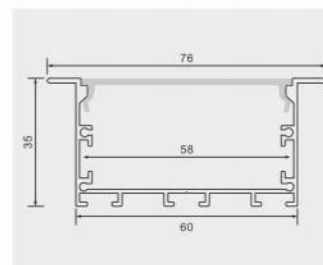



## 7035M

### 产品参数

尺寸: Lx70x35mm  
材质: 6063-T5 铝合金  
表面: 氧化铝本色/喷漆 (黑色/白色)  
PC罩: 乳白/黑色/亚克力磨砂可选  
适用: 67MM软灯带/硬灯条

### Description

size: Lx70x35mm  
Material: 6063-T5  
Surface: Silver / black / white Anodized  
PC cover: Milky white/black/acrylic matte  
Apply: LED Strips and PCB 67mm

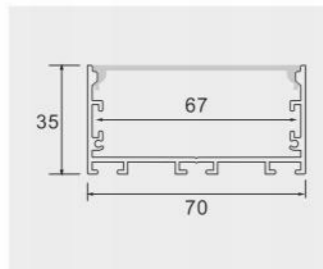

## 7035A

### 产品参数

尺寸: Lx86x35mm  
材质: 6063-T5 铝合金  
表面: 氧化铝本色/喷漆 (黑色/白色)  
PC罩: 乳白/黑色/亚克力磨砂可选  
适用: 67MM软灯带/硬灯条

### Description

size: Lx86x35mm  
Material: 6063-T5  
Surface: Silver / black / white Anodized  
PC cover: Milky white/black/acrylic matte  
Apply: LED Strips and PCB 67mm

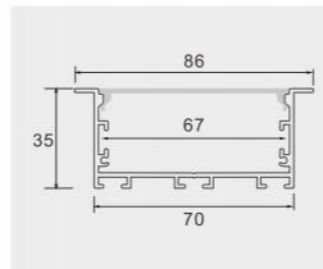

## 7075M

### 产品参数

尺寸: Lx70x75mm  
材质: 6063-T5 铝合金  
表面: 氧化铝本色/喷漆 (黑色/白色)  
PC罩: 乳白/黑色/亚克力磨砂可选  
适用: 45MM软灯带/硬灯条

### Description

size: Lx70x75mm  
Material: 6063-T5  
Surface: Silver / black / white Anodized  
PC cover: Milky white/black/acrylic matte  
Apply: LED Strips and PCB 45mm

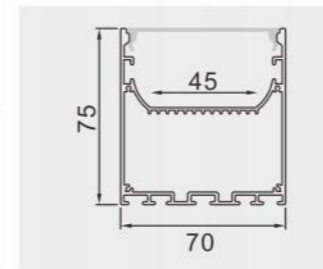

## 7635M

### 产品参数

尺寸: Lx76x35mm  
材质: 6063-T5 铝合金  
表面: 氧化铝本色/喷漆 (黑色/白色)  
PC罩: 乳白/黑色/亚克力磨砂可选  
适用: 54MM软灯带/硬灯条

### Description

size: Lx76x35mm  
Material: 6063-T5  
Surface: Silver / black / white Anodized  
PC cover: Milky white/black/acrylic matte  
Apply: LED Strips and PCB 54mm

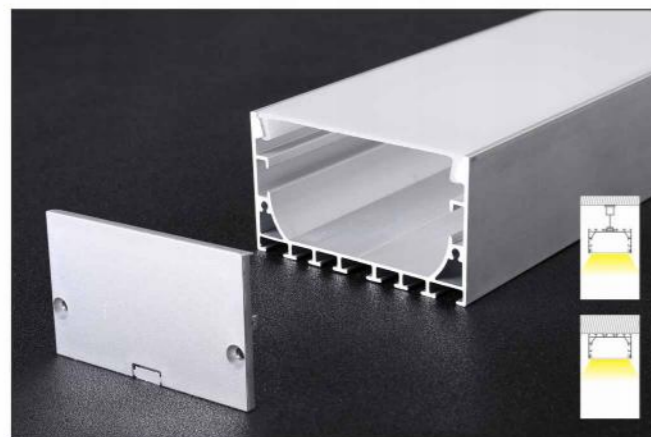
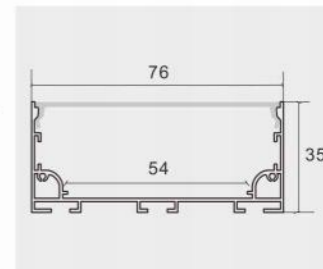

## 7040M

### 产品参数

尺寸: Lx70x40mm  
材质: 6063-T5 铝合金  
表面: 氧化铝本色/喷漆 (黑色/白色)  
PC罩: 乳白/黑色/亚克力磨砂可选  
适用: 45MM软灯带/硬灯条

### Description

size: Lx70x40mm  
Material: 6063-T5  
Surface: Silver / black / white Anodized  
PC cover: Milky white/black/acrylic matte  
Apply: LED Strips and PCB 45mm

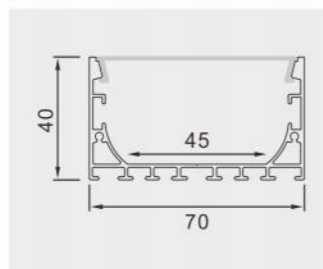

## 7040A

### 产品参数

尺寸: Lx86x40mm  
材质: 6063-T5 铝合金  
表面: 氧化铝本色/喷漆 (黑色/白色)  
PC罩: 乳白/黑色/亚克力磨砂可选  
适用: 45MM软灯带/硬灯条

### Description

size: Lx86x40mm  
Material: 6063-T5  
Surface: Silver / black / white Anodized  
PC cover: Milky white/black/acrylic matte  
Apply: LED Strips and PCB 45mm

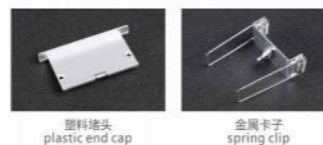
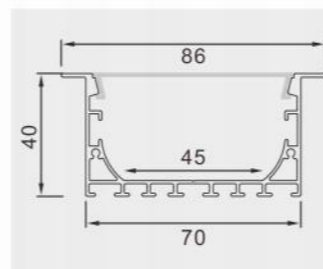

## 7635A

### 产品参数

尺寸: Lx90x35mm  
材质: 6063-T5 铝合金  
表面: 氧化铝本色/喷漆 (黑色/白色)  
PC罩: 乳白/黑色/亚克力磨砂可选  
适用: 53MM软灯带/硬灯条

### Description

size: Lx90x35mm  
Material: 6063-T5  
Surface: Silver / black / white Anodized  
PC cover: Milky white/black/acrylic matte  
Apply: LED Strips and PCB 53mm

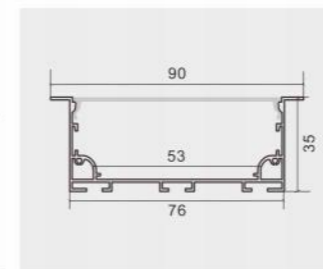

## 7635M厚款

### 产品参数

尺寸: Lx76x35mm  
材质: 6063-T5 铝合金  
表面: 氧化铝本色/喷漆 (黑色/白色)  
PC罩: 乳白/黑色/亚克力磨砂可选  
适用: 67MM软灯带/硬灯条

### Description

size: Lx76x35mm  
Material: 6063-T5  
Surface: Silver / black / white Anodized  
PC cover: Milky white/black/acrylic matte  
Apply: LED Strips and PCB 67mm

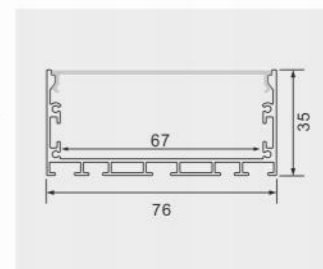

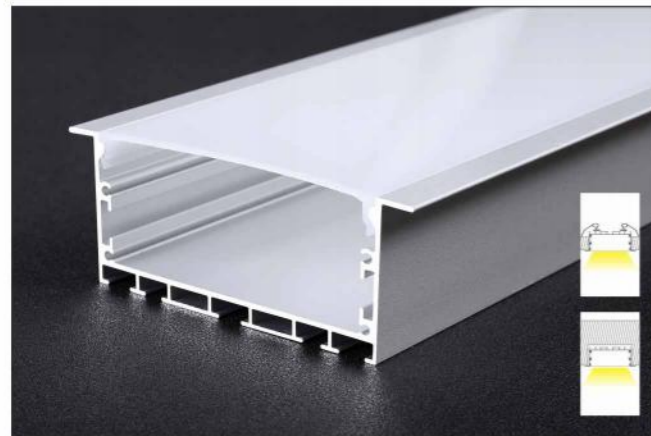

## 7635A厚款

**产品参数**  
尺寸: Lx92.5x35mm  
材质: 6063-T5 铝合金  
表面: 氧化铝本色/喷漆 (黑色/白色)  
PC罩: 乳白/黑色/亚克力磨砂可选  
适用: 67MM软灯带/硬灯条

**Description**  
size: Lx92.5x35mm  
Material: 6063-T5  
Surface: Silver / black / white Anodized  
PC cover: Milky white/black/acrylic matte  
Apply: LED Strips and PCB 67mm

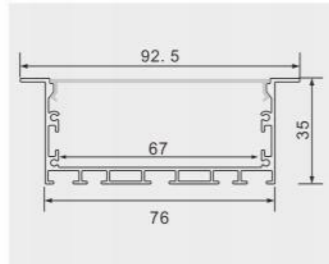

## 7676M

**产品参数**  
尺寸: Lx76x76mm  
材质: 6063-T5 铝合金  
表面: 氧化铝本色/喷漆 (黑色/白色)  
PC罩: 乳白/黑色/亚克力磨砂可选  
适用: 54MM软灯带/硬灯条

**Description**  
size: Lx76x76mm  
Material: 6063-T5  
Surface: Silver / black / white Anodized  
PC cover: Milky white/black/acrylic matte  
Apply: LED Strips and PCB 54mm

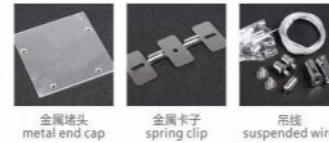
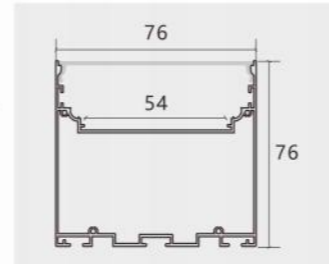

## 8040M

**产品参数**  
尺寸: Lx80x40mm  
材质: 6063-T5 铝合金  
表面: 氧化铝本色/喷漆 (黑色/白色)  
PC罩: 乳白/黑色/亚克力磨砂可选  
适用: 55MM软灯带/硬灯条

**Description**  
size: Lx80x40mm  
Material: 6063-T5  
Surface: Silver / black / white Anodized  
PC cover: Milky white/black/acrylic matte  
Apply: LED Strips and PCB 55mm

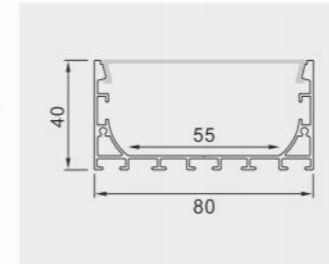

## 8040A

**产品参数**  
尺寸: Lx96x40mm  
材质: 6063-T5 铝合金  
表面: 氧化铝本色/喷漆 (黑色/白色)  
PC罩: 乳白/黑色/亚克力磨砂可选  
适用: 55MM软灯带/硬灯条

**Description**  
size: Lx96x40mm  
Material: 6063-T5  
Surface: Silver / black / white Anodized  
PC cover: Milky white/black/acrylic matte  
Apply: LED Strips and PCB 55mm

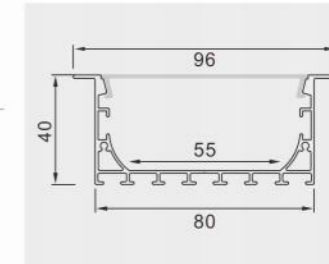

## 8035M

**产品参数**  
尺寸: Lx80x35mm  
材质: 6063-T5 铝合金  
表面: 氧化铝本色/喷漆 (黑色/白色)  
PC罩: 乳白/黑色/亚克力磨砂可选  
适用: 77MM软灯带/硬灯条

**Description**  
size: Lx80x35mm  
Material: 6063-T5  
Surface: Silver / black / white Anodized  
PC cover: Milky white/black/acrylic matte  
Apply: LED Strips and PCB 77mm

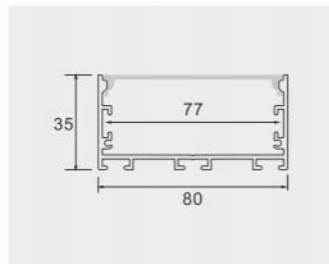

## 8035A

**产品参数**  
尺寸: Lx96x35mm  
材质: 6063-T5 铝合金  
表面: 氧化铝本色/喷漆 (黑色/白色)  
PC罩: 乳白/黑色/亚克力磨砂可选  
适用: 77MM软灯带/硬灯条

**Description**  
size: Lx96x35mm  
Material: 6063-T5  
Surface: Silver / black / white Anodized  
PC cover: Milky white/black/acrylic matte  
Apply: LED Strips and PCB 77mm

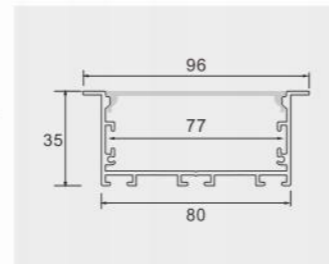

## 8075M

**产品参数**  
尺寸: Lx80x75mm  
材质: 6063-T5 铝合金  
表面: 氧化铝本色/喷漆 (黑色/白色)  
PC罩: 乳白/黑色/亚克力磨砂可选  
适用: 55MM软灯带/硬灯条

**Description**  
size: Lx80x75mm  
Material: 6063-T5  
Surface: Silver / black / white Anodized  
PC cover: Milky white/black/acrylic matte  
Apply: LED Strips and PCB 55mm

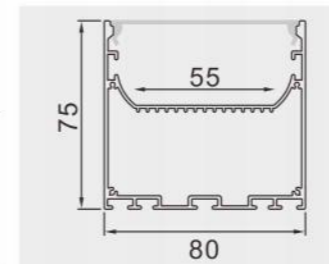

## 10035M厚款

**产品参数**  
尺寸: Lx98.5x35mm  
材质: 6063-T5 铝合金  
表面: 氧化铝本色/喷漆 (黑色/白色)  
PC罩: 乳白/黑色/亚克力磨砂可选  
适用: 88MM软灯带/硬灯条

**Description**  
size: Lx98.5x35mm  
Material: 6063-T5  
Surface: Silver / black / white Anodized  
PC cover: Milky white/black/acrylic matte  
Apply: LED Strips and PCB 88mm

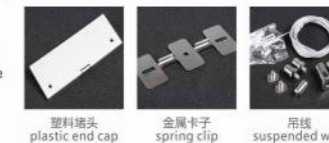
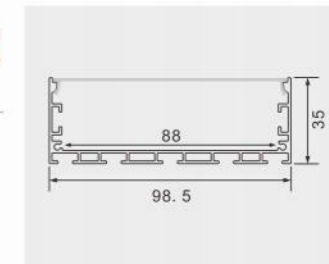

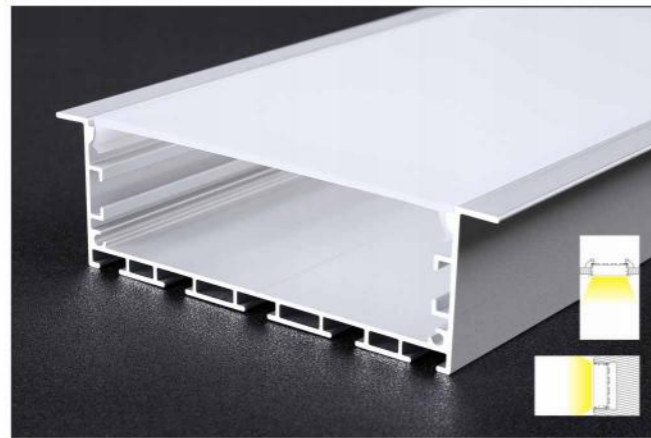

## 10035A厚款

产品参数

尺寸: Lx116.5x35mm  
材质: 6063-T5 铝合金  
表面: 氧化铝本色/喷漆 (黑色/白色)  
PC罩: 乳白/黑色/亚克力磨砂可选  
适用: 88MM软灯带/硬灯条

Description

size: Lx116.5x35mm  
Material: 6063-T5  
Surface: Silver / black / white Anodized  
PC cover: Milky white/black/acrylic matte  
Apply: LED Strips and PCB 88mm

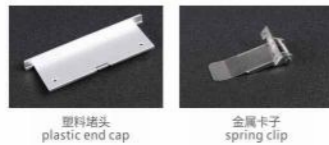
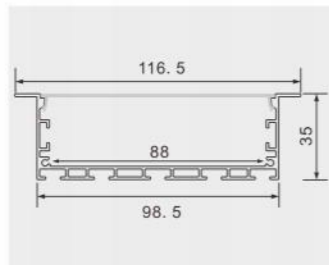

## 10040M

产品参数

尺寸: Lx100x40mm  
材质: 6063-T5 铝合金  
表面: 氧化铝本色/喷漆 (黑色/白色)  
PC罩: 乳白/黑色/亚克力磨砂可选  
适用: 75MM软灯带/硬灯条

Description

size: Lx100x40mm  
Material: 6063-T5  
Surface: Silver / black / white Anodized  
PC cover: Milky white/black/acrylic matte  
Apply: LED Strips and PCB 75mm

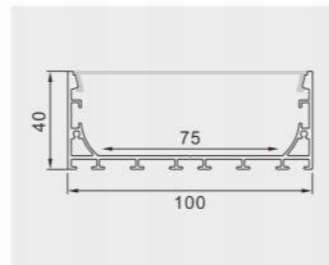

## 10235M

产品参数

尺寸: Lx102x35mm  
材质: 6063-T5 铝合金  
表面: 氧化铝本色/喷漆 (黑色/白色)  
PC罩: 乳白/黑色/亚克力磨砂可选  
适用: 80MM软灯带/硬灯条

Description

size: Lx102x35mm  
Material: 6063-T5  
Surface: Silver / black / white Anodized  
PC cover: Milky white/black/acrylic matte  
Apply: LED Strips and PCB 80mm

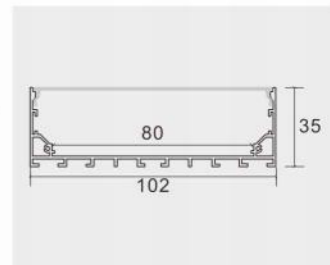

## 10040A

产品参数

尺寸: Lx116x40mm  
材质: 6063-T5 铝合金  
表面: 氧化铝本色/喷漆 (黑色/白色)  
PC罩: 乳白/黑色/亚克力磨砂可选  
适用: 75MM软灯带/硬灯条

Description

size: Lx116x40mm  
Material: 6063-T5  
Surface: Silver / black / white Anodized  
PC cover: Milky white/black/acrylic matte  
Apply: LED Strips and PCB 75mm

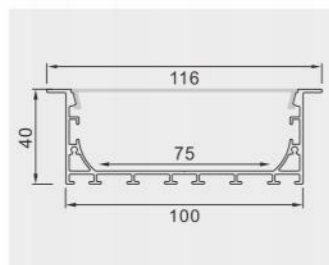

## 10075M

产品参数

尺寸: Lx100x75mm  
材质: 6063-T5 铝合金  
表面: 氧化铝本色/喷漆 (黑色/白色)  
PC罩: 乳白/黑色/亚克力磨砂可选  
适用: 75MM软灯带/硬灯条

Description

size: Lx100x75mm  
Material: 6063-T5  
Surface: Silver / black / white Anodized  
PC cover: Milky white/black/acrylic matte  
Apply: LED Strips and PCB 75mm

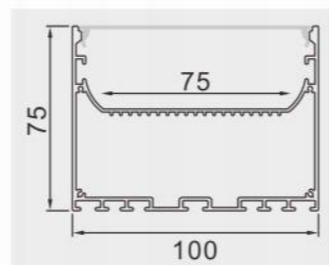

## 10235A

产品参数

尺寸: Lx118x35mm  
材质: 6063-T5 铝合金  
表面: 氧化铝本色/喷漆 (黑色/白色)  
PC罩: 乳白/黑色/亚克力磨砂可选  
适用: 80MM软灯带/硬灯条

Description

size: Lx118x35mm  
Material: 6063-T5  
Surface: Silver / black / white Anodized  
PC cover: Milky white/black/acrylic matte  
Apply: LED Strips and PCB 80mm

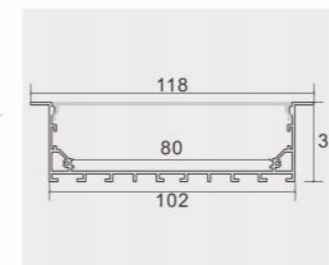

## 12035M

产品参数

尺寸: Lx120x35mm  
材质: 6063-T5 铝合金  
表面: 氧化铝本色/喷漆 (黑色/白色)  
PC罩: 乳白/黑色/亚克力磨砂可选  
适用: 116MM软灯带/硬灯条

Description

size: Lx120x35mm  
Material: 6063-T5  
Surface: Silver / black / white Anodized  
PC cover: Milky white/black/acrylic matte  
Apply: LED Strips and PCB 116mm

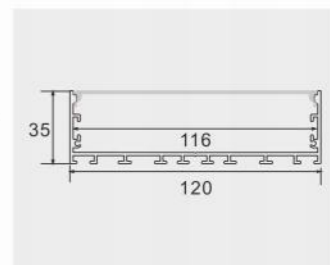



## 12035A

产品参数

尺寸: Lx135x35mm  
材质: 6063-T5 铝合金  
表面: 氧化铝本色/喷漆 (黑色/白色)  
PC罩: 乳白/黑色/亚克力磨砂可选  
适用: 116MM软灯带/硬灯条

Description

size: Lx135x35mm  
Material: 6063-T5  
Surface: Silver / black / white Anodized  
PC cover: Milky white/black/acrylic matte  
Apply: LED Strips and PCB 116mm

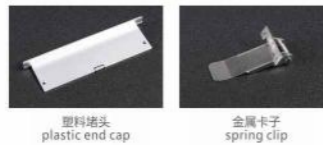
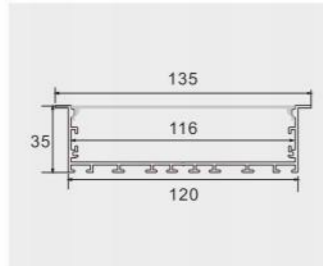

## 12040M

产品参数

尺寸: Lx120x40mm  
材质: 6063-T5 铝合金  
表面: 氧化铝本色/喷漆 (黑色/白色)  
PC罩: 乳白/黑色/亚克力磨砂可选  
适用: 95MM软灯带/硬灯条

Description

size: Lx120x40mm  
Material: 6063-T5  
Surface: Silver / black / white Anodized  
PC cover: Milky white/black/acrylic matte  
Apply: LED Strips and PCB 95mm

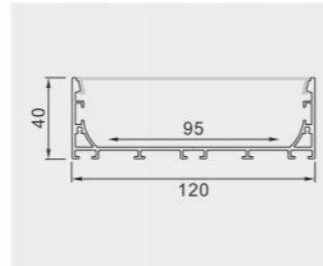

## 15035M

产品参数

尺寸: Lx150x35mm  
材质: 6063-T5 铝合金  
表面: 氧化铝本色/喷漆 (黑色/白色)  
PC罩: 乳白/黑色/亚克力磨砂可选  
适用: 146MM软灯带/硬灯条

Description

size: Lx150x35mm  
Material: 6063-T5  
Surface: Silver / black / white Anodized  
PC cover: Milky white/black/acrylic matte  
Apply: LED Strips and PCB 146mm

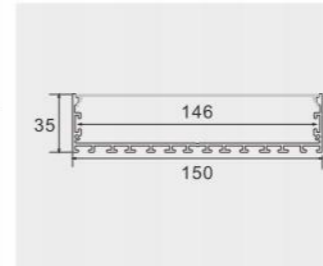

## 15035A

产品参数

尺寸: Lx165x35mm  
材质: 6063-T5 铝合金  
表面: 氧化铝本色/喷漆 (黑色/白色)  
PC罩: 乳白/黑色/亚克力磨砂可选  
适用: 146MM软灯带/硬灯条

Description

size: Lx165x35mm  
Material: 6063-T5  
Surface: Silver / black / white Anodized  
PC cover: Milky white/black/acrylic matte  
Apply: LED Strips and PCB 146mm

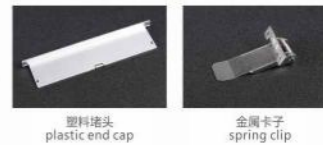
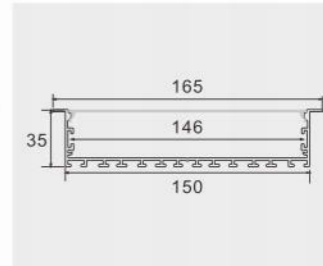

## 12040A

产品参数

尺寸: Lx136x40mm  
材质: 6063-T5 铝合金  
表面: 氧化铝本色/喷漆 (黑色/白色)  
PC罩: 乳白/黑色/亚克力磨砂可选  
适用: 95MM软灯带/硬灯条

Description

size: Lx136x40mm  
Material: 6063-T5  
Surface: Silver / black / white Anodized  
PC cover: Milky white/black/acrylic matte  
Apply: LED Strips and PCB 95mm

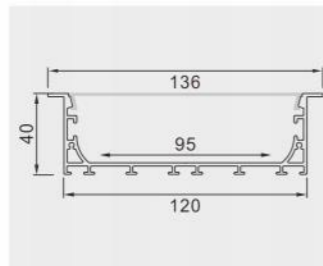

## 12085M

产品参数

尺寸: Lx120x85mm  
材质: 6063-T5 铝合金  
表面: 氧化铝本色/喷漆 (黑色/白色)  
PC罩: 乳白/黑色/亚克力磨砂可选  
适用: 95MM软灯带/硬灯条

Description

size: Lx120x85mm  
Material: 6063-T5  
Surface: Silver / black / white Anodized  
PC cover: Milky white/black/acrylic matte  
Apply: LED Strips and PCB 95mm

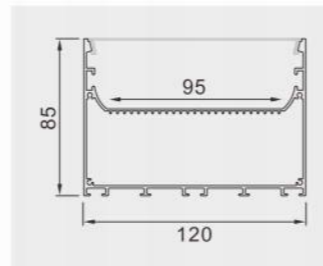

## 15050M

产品参数

尺寸: Lx150x50mm  
材质: 6063-T5 铝合金  
表面: 氧化铝本色/喷漆 (黑色/白色)  
PC罩: 乳白/黑色/亚克力磨砂可选  
适用: 125MM软灯带/硬灯条

Description

size: Lx150x50mm  
Material: 6063-T5  
Surface: Silver / black / white Anodized  
PC cover: Milky white/black/acrylic matte  
Apply: LED Strips and PCB 125mm

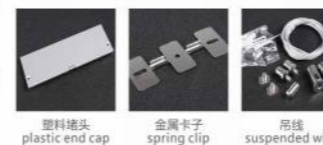
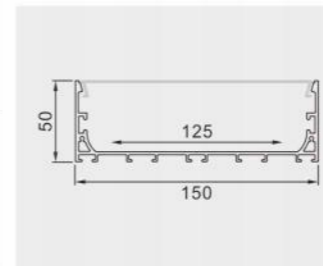

## 15050A

产品参数

尺寸: Lx166x50mm  
材质: 6063-T5 铝合金  
表面: 氧化铝本色/喷漆 (黑色/白色)  
PC罩: 乳白/黑色/亚克力磨砂可选  
适用: 125MM软灯带/硬灯条

Description

size: Lx166x50mm  
Material: 6063-T5  
Surface: Silver / black / white Anodized  
PC cover: Milky white/black/acrylic matte  
Apply: LED Strips and PCB 125mm

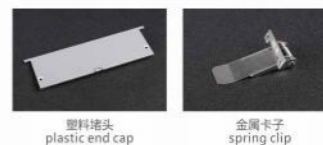
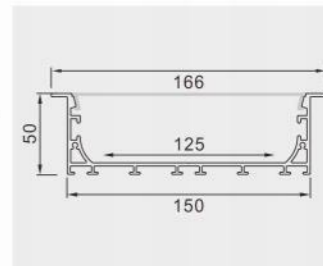

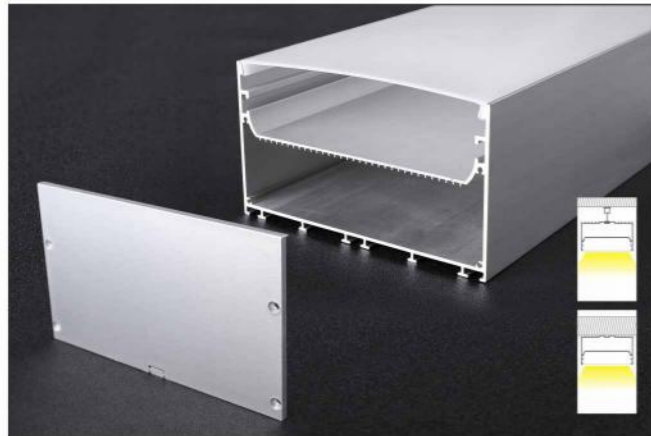

## 15085M

产品参数

尺寸: Lx150x85mm  
材质: 6063-T5 铝合金  
表面: 氧化铝本色/喷漆 (黑色/白色)  
PC罩: 乳白/黑色/亚克力磨砂可选  
适用: 125MM软灯带/硬灯条

Description

size: Lx150x85mm  
Material: 6063-T5  
Surface: Silver / black / white Anodized  
PC cover: Milky white/black/acrylic matte  
Apply: LED Strips and PCB 125mm

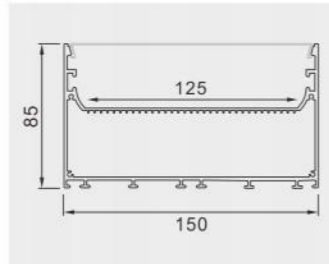

## 20050M

产品参数

尺寸: Lx200x50mm  
材质: 6063-T5 铝合金  
表面: 氧化铝本色/喷漆 (黑色/白色)  
PC罩: 乳白/黑色/亚克力磨砂可选  
适用: 173MM软灯带/硬灯条

Description

size: Lx200x50mm  
Material: 6063-T5  
Surface: Silver / black / white Anodized  
PC cover: Milky white/black/acrylic matte  
Apply: LED Strips and PCB 173mm

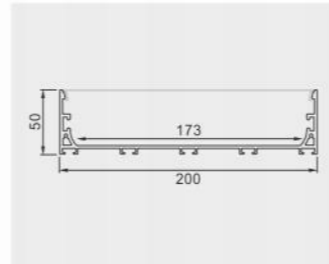

## 20050A

产品参数

尺寸: Lx216x50mm  
材质: 6063-T5 铝合金  
表面: 氧化铝本色/喷漆 (黑色/白色)  
PC罩: 乳白/黑色/亚克力磨砂可选  
适用: 173MM软灯带/硬灯条

Description

size: Lx216x50mm  
Material: 6063-T5  
Surface: Silver / black / white Anodized  
PC cover: Milky white/black/acrylic matte  
Apply: LED Strips and PCB 173mm

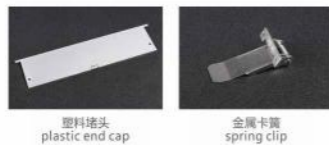
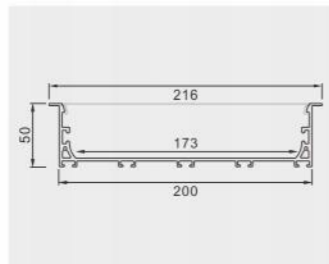

# 夹层灯 铝型材套件

»» P37-P38

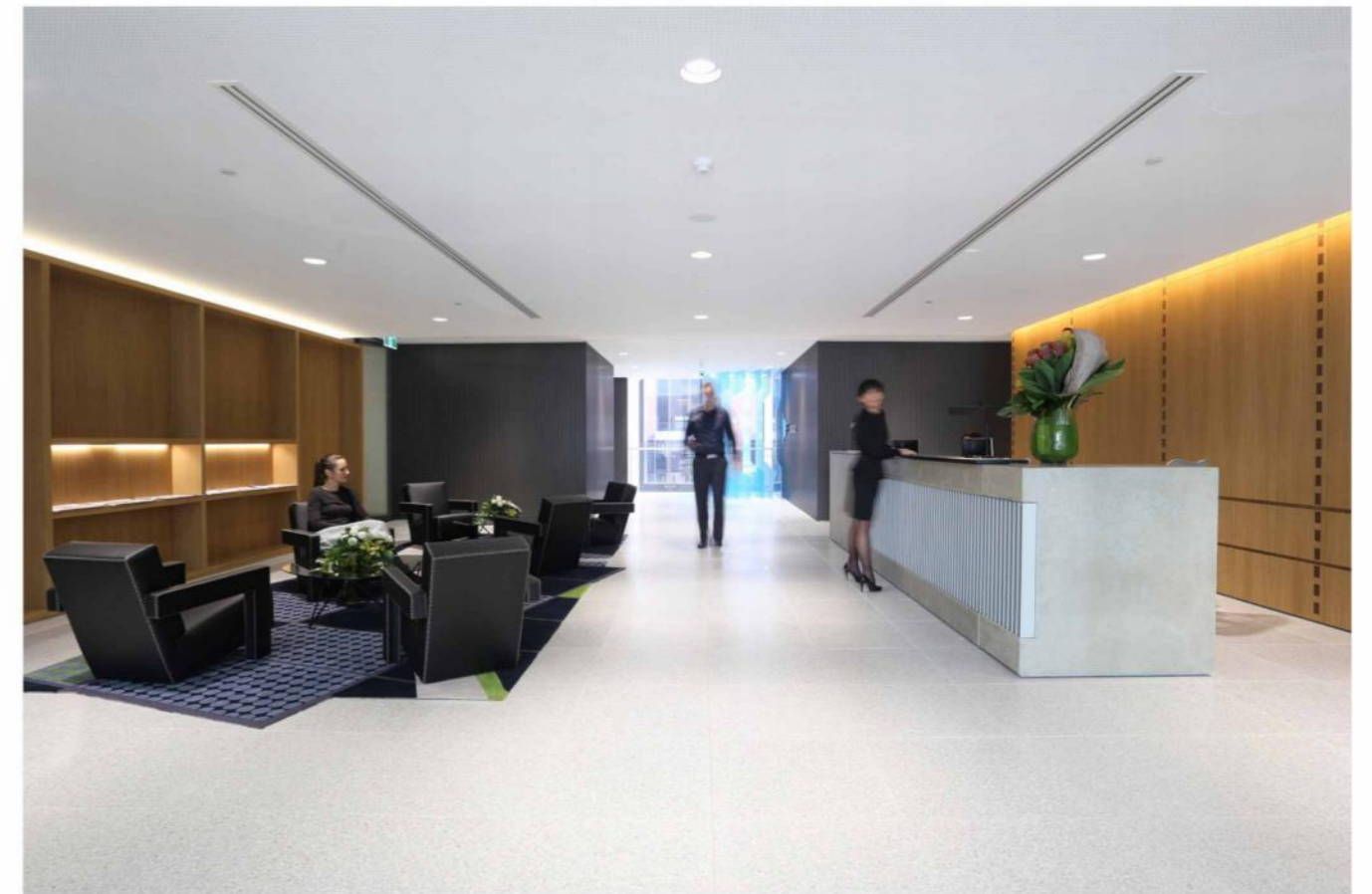

2022  
NEW STYLE



## 层板-明

### 产品参数

尺寸: Lx20.8x8.8mm  
材质: 6063-T5 铝合金  
表面: 氧化铝本色/喷漆 (黑色/白色)  
PC罩: 乳白/黑色/亚克力磨砂可选  
适用: 5MM软灯带/硬灯条

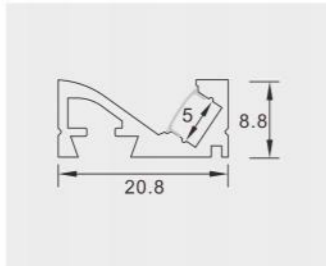

### Description

size: Lx20.8x8.8mm  
Material: 6063-T5  
Surface: Silver / black / white Anodized  
PC cover: Milky white/black/acrylic matte  
Apply: LED Strips and PCB 5mm



塑料堵头  
plastic end cap

金属卡子  
spring clip



## 层板-暗

### 产品参数

尺寸: Lx23.8x8.8mm  
材质: 6063-T5 铝合金  
表面: 氧化铝本色/喷漆 (黑色/白色)  
PC罩: 乳白/黑色/亚克力磨砂可选  
适用: 5MM软灯带/硬灯条

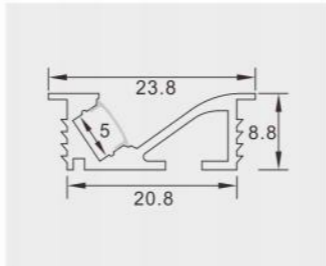

### Description

size: Lx23.8x8.8mm  
Material: 6063-T5  
Surface: Silver / black / white Anodized  
PC cover: Milky white/black/acrylic matte  
Apply: LED Strips and PCB 5mm

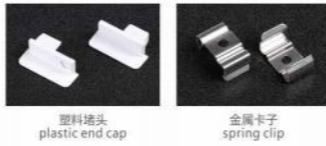

塑料堵头  
plastic end cap

金属卡子  
spring clip

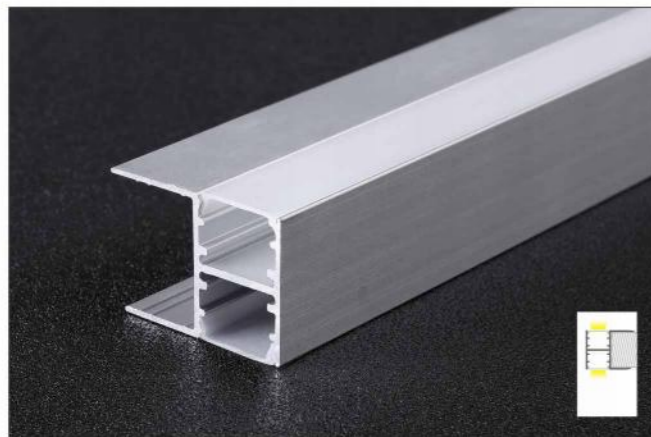

## 2028

### 产品参数

尺寸: Lx20x28mm  
材质: 6063-T5 铝合金  
表面: 氧化铝本色/喷漆 (黑色/白色)  
PC罩: 乳白/黑色/亚克力磨砂可选  
适用: 12MM软灯带/硬灯条

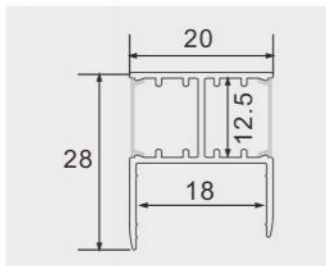

### Description

size: Lx20x28mm  
Material: 6063-T5  
Surface: Silver / black / white Anodized  
PC cover: Milky white/black/acrylic matte  
Apply: LED Strips and PCB 12mm



# 多面发光线条灯

## 铝型材套件

»» P39-P40

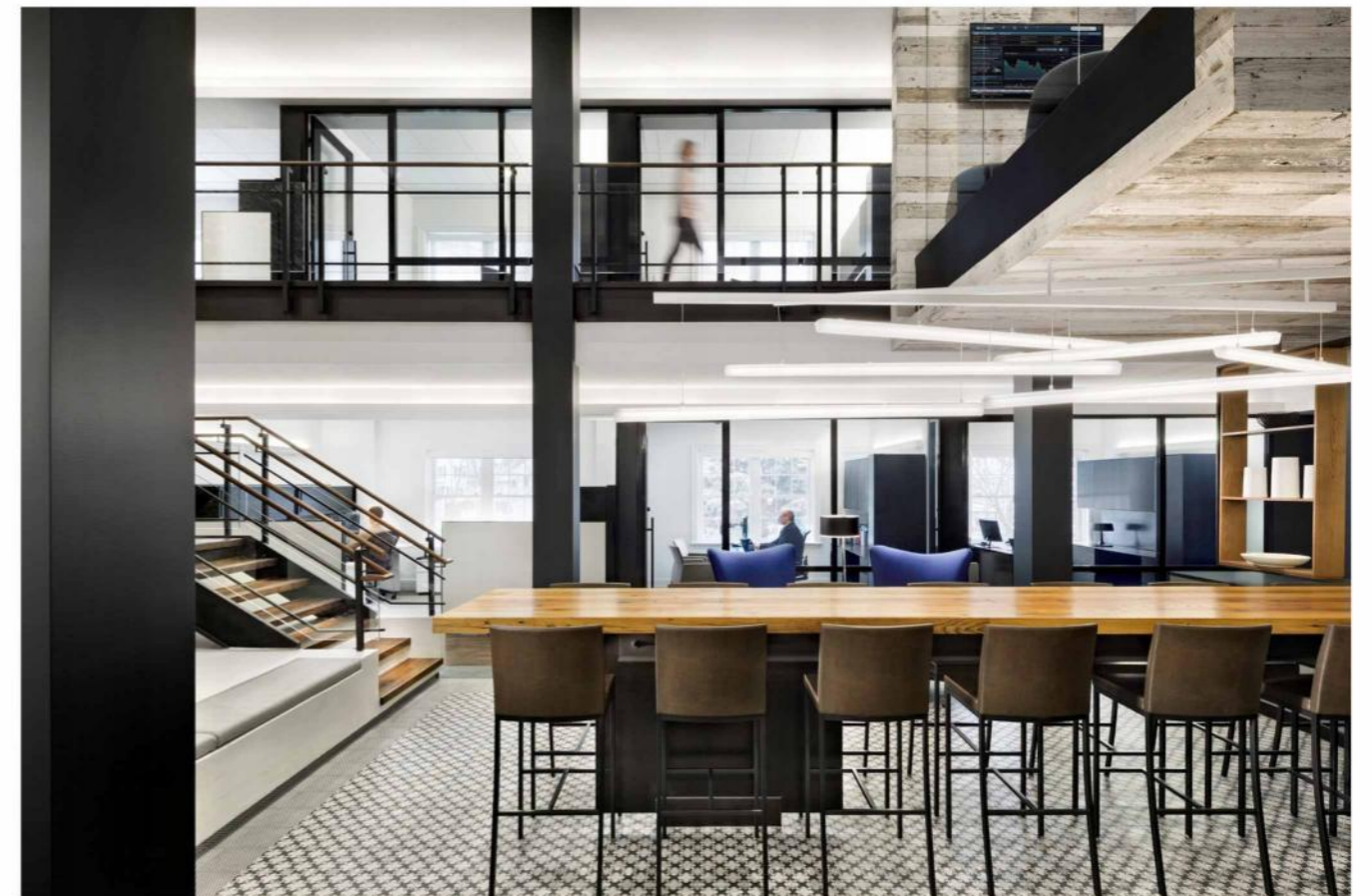

2022  
NEW STYLE





**Ø30**

产品参数  
尺寸: LxØ30mm  
材质: 6063-T5 铝合金  
表面: 氧化铝本色/喷漆 (黑色/白色)  
PC罩: 乳白/黑色/亚克力磨砂可选  
适用: 20MM软灯带/硬灯条

Description  
size: LxØ30mm  
Material: 6063-T5  
Surface: Silver / black / white Anodized  
PC cover: Milky white/black/acrylic matte  
Apply: LED Strips and PCB 20mm

塑料堵头 plastic end cap      金属卡子 spring clip



**Ø60**

产品参数  
尺寸: LxØ60mm  
材质: 6063-T5 铝合金  
表面: 氧化铝本色/喷漆 (黑色/白色)  
PC罩: 乳白/黑色/亚克力磨砂可选  
适用: 30MM软灯带/硬灯条

Description  
size: LxØ60mm  
Material: 6063-T5  
Surface: Silver / black / white Anodized  
PC cover: Milky white/black/acrylic matte  
Apply: LED Strips and PCB 30mm

塑料堵头 plastic end cap      金属卡子 spring clip      吊线 suspended wire



**4542方**

产品参数  
尺寸: Lx45x42mm  
材质: 6063-T5 铝合金  
表面: 氧化铝本色/喷漆 (黑色/白色)  
PC罩: 乳白/黑色/亚克力磨砂可选  
适用: 35MM软灯带/硬灯条

Description  
size: Lx45x42mm  
Material: 6063-T5  
Surface: Silver / black / white Anodized  
PC cover: Milky white/black/acrylic matte  
Apply: LED Strips and PCB 35mm

金属堵头 metal end cap      金属卡子 spring clip      吊线 suspended wire



**4542圆**

产品参数  
尺寸: Lx45x42mm  
材质: 6063-T5 铝合金  
表面: 氧化铝本色/喷漆 (黑色/白色)  
PC罩: 乳白/黑色/亚克力磨砂可选  
适用: 35MM软灯带/硬灯条

Description  
size: Lx45x42mm  
Material: 6063-T5  
Surface: Silver / black / white Anodized  
PC cover: Milky white/black/acrylic matte  
Apply: LED Strips and PCB 35mm

金属堵头 metal end cap      金属卡子 spring clip      吊线 suspended wire

## 阴阳角线条灯

### 铝型材套件

»» P41-P46

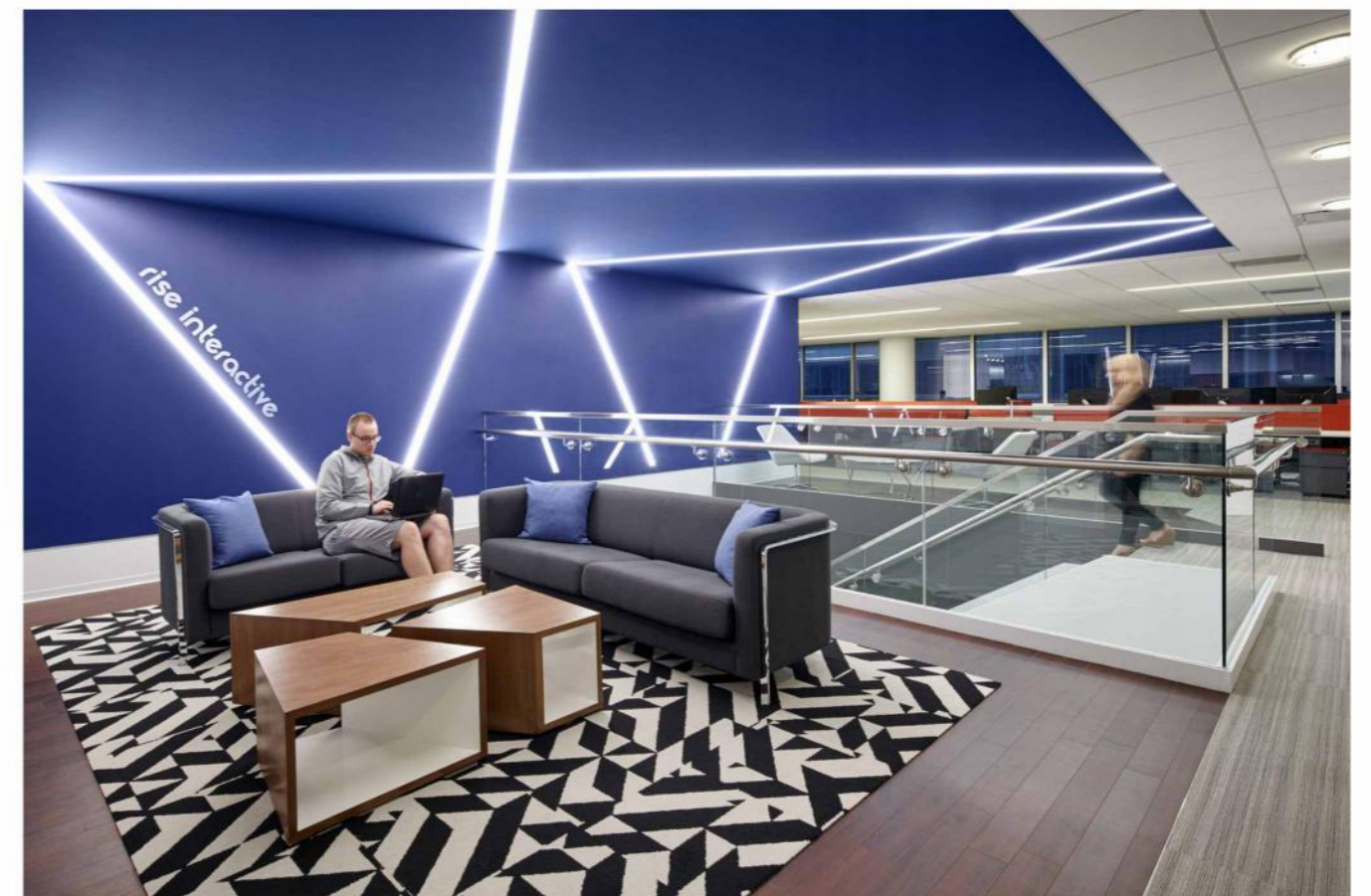

2022  
NEW STYLE



## 702

### 产品参数

尺寸: Lx32.5x13.3mm  
材质: 6063-T5 铝合金  
表面: 氧化铝本色/喷漆 (黑色/白色)  
PC罩: 乳白/黑色/亚克力磨砂可选  
适用: 9MM软灯带/硬灯条

### Description

size: Lx32.5x13.3mm  
Material: 6063-T5  
Surface: Silver / black / white Anodized  
PC cover: Milky white/black/acrylic matte  
Apply: LED Strips and PCB 9mm

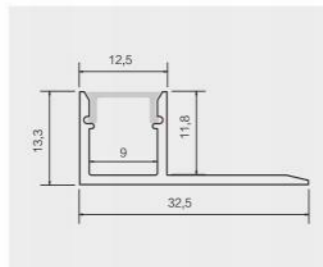

塑料堵头  
plastic end cap

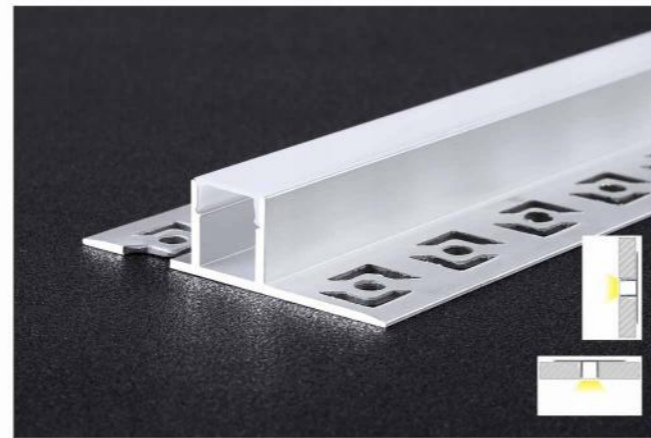

## 703

### 产品参数

尺寸: Lx52.5x13.7mm  
材质: 6063-T5 铝合金  
表面: 氧化铝本色/喷漆 (黑色/白色)  
PC罩: 乳白/黑色/亚克力磨砂可选  
适用: 9.9MM软灯带/硬灯条

### Description

size: Lx52.5x13.7mm  
Material: 6063-T5  
Surface: Silver / black / white Anodized  
PC cover: Milky white/black/acrylic matte  
Apply: LED Strips and PCB 9.9mm

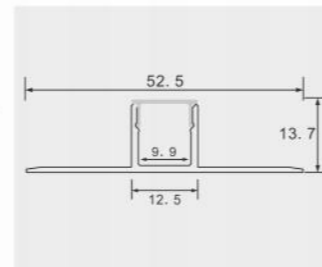

塑料堵头  
plastic end cap



## 707阴角

### 产品参数

尺寸: Lx41.3x41.3mm  
材质: 6063-T5 铝合金  
表面: 氧化铝本色/喷漆 (黑色/白色)  
PC罩: 乳白/黑色/亚克力磨砂可选  
适用: 9MM软灯带/硬灯条

### Description

size: Lx48x27mm  
Material: 6063-T5  
Surface: Silver / black / white Anodized  
PC cover: Milky white/black/acrylic matte  
Apply: LED Strips and PCB 9mm

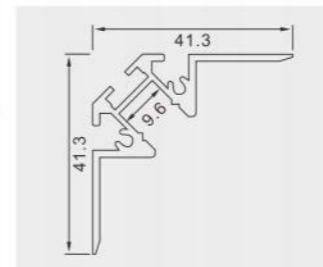

塑料堵头  
plastic end cap

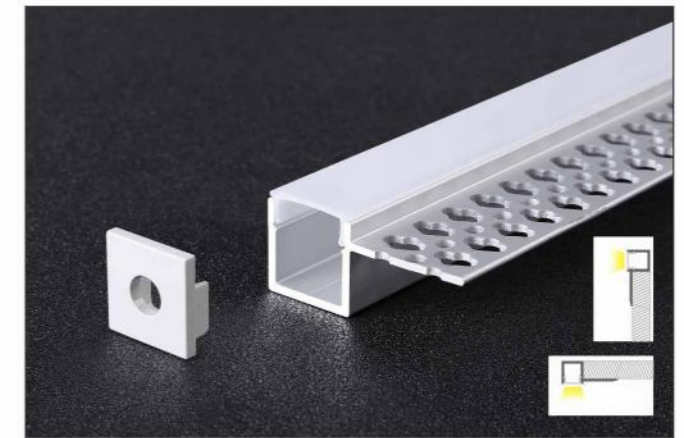

## 701米字

### 产品参数

尺寸: Lx35.5x15mm  
材质: 6063-T5 铝合金  
表面: 氧化铝本色/喷漆 (黑色/白色)  
PC罩: 乳白/黑色/亚克力磨砂可选  
适用: 12MM软灯带/硬灯条

### Description

size: Lx35.5x15mm  
Material: 6063-T5  
Surface: Silver / black / white Anodized  
PC cover: Milky white/black/acrylic matte  
Apply: LED Strips and PCB 12mm

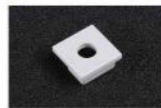
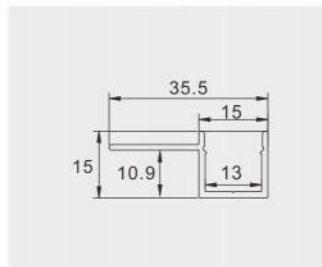

塑料堵头  
plastic end cap



## 639新款

### 产品参数

尺寸: Lx52.5x13.3mm  
材质: 6063-T5 铝合金  
表面: 氧化铝本色/喷漆 (黑色/白色)  
PC罩: 乳白/黑色/亚克力磨砂可选  
适用: 9MM软灯带/硬灯条

### Description

size: Lx52.5x13.3mm  
Material: 6063-T5  
Surface: Silver / black / white Anodized  
PC cover: Milky white/black/acrylic matte  
Apply: LED Strips and PCB 9mm

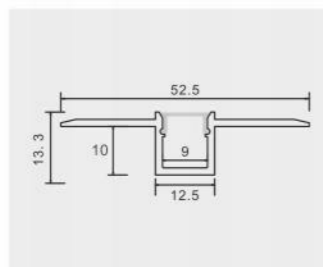

塑料堵头  
plastic end cap



## 707阳角

### 产品参数

尺寸: Lx41.3x41.3mm  
材质: 6063-T5 铝合金  
表面: 氧化铝本色/喷漆 (黑色/白色)  
PC罩: 乳白/黑色/亚克力磨砂可选  
适用: 9MM软灯带/硬灯条

### Description

size: Lx41.3x41.3mm  
Material: 6063-T5  
Surface: Silver / black / white Anodized  
PC cover: Milky white/black/acrylic matte  
Apply: LED Strips and PCB 9mm

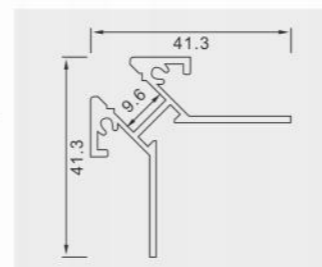

塑料堵头  
plastic end cap

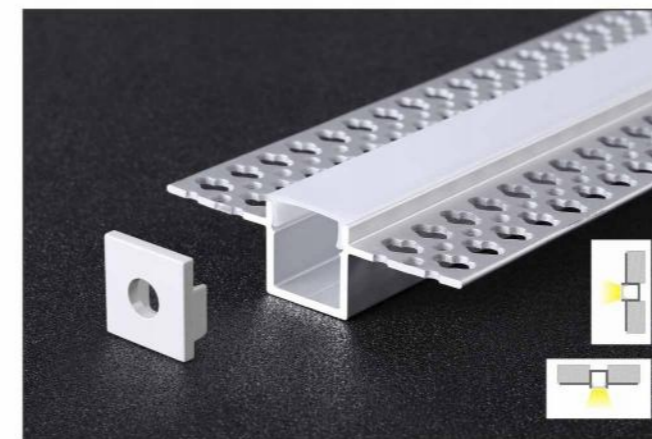

## 639米字

### 产品参数

尺寸: Lx56x15mm  
材质: 6063-T5 铝合金  
表面: 氧化铝本色/喷漆 (黑色/白色)  
PC罩: 乳白/黑色/亚克力磨砂可选  
适用: 12MM软灯带/硬灯条

### Description

size: Lx56x15mm  
Material: 6063-T5  
Surface: Silver / black / white Anodized  
PC cover: Milky white/black/acrylic matte  
Apply: LED Strips and PCB 12mm

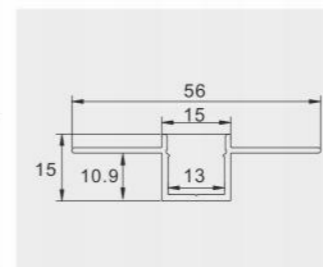

塑料堵头  
plastic end cap

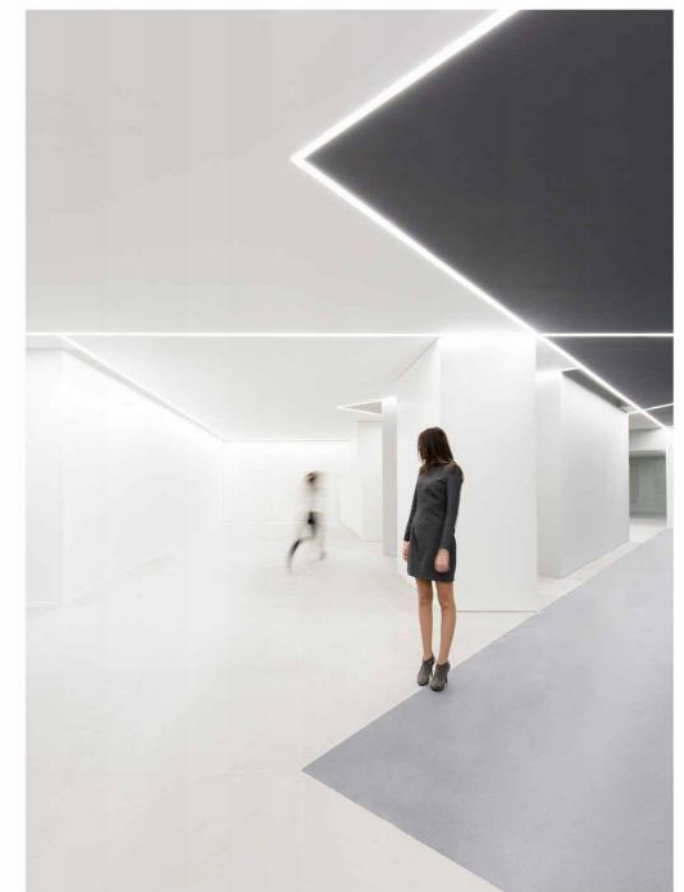

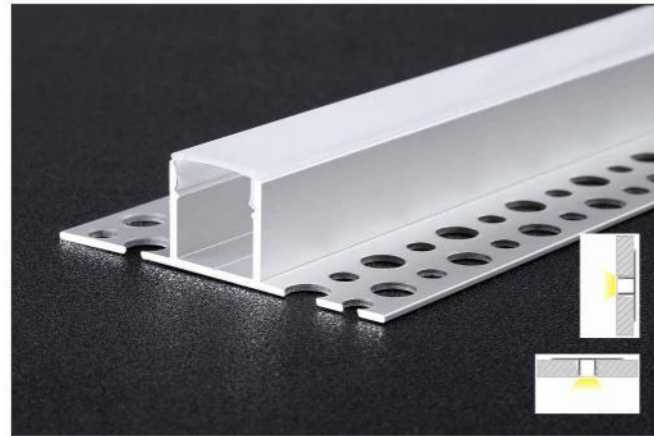

## 639米字下花边

产品参数

尺寸: Lx55.5x15.7mm  
材质: 6063-T5 铝合金  
表面: 氧化铝本色/喷漆 (黑色/白色)  
PC罩: 乳白/黑色/亚克力磨砂可选  
适用: 12MM软灯带/硬灯条

Description

size: Lx55.5x15.7mm  
Material: 6063-T5  
Surface: Silver / black / white Anodized  
PC cover: Milky white/black/acrylic matte  
Apply: LED Strips and PCB 12mm

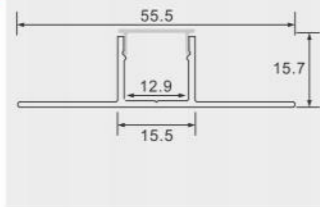

塑料堵头  
plastic end cap

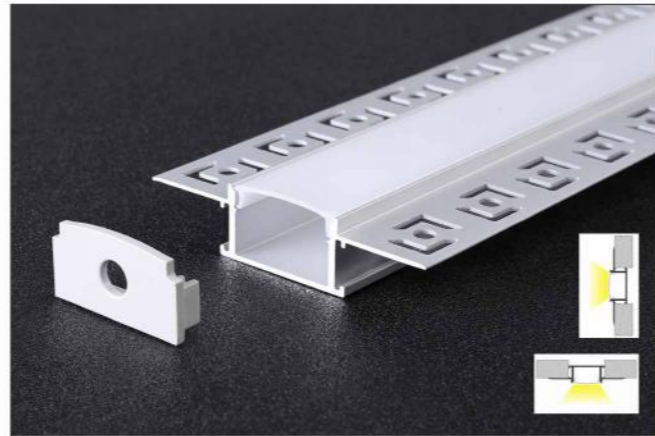

## 6114

产品参数

尺寸: Lx61x14mm  
材质: 6063-T5 铝合金  
表面: 氧化铝本色/喷漆 (黑色/白色)  
PC罩: 乳白/黑色/亚克力磨砂可选  
适用: 20MM软灯带/硬灯条

Description

size: Lx61x14mm  
Material: 6063-T5  
Surface: Silver / black / white Anodized  
PC cover: Milky white/black/acrylic matte  
Apply: LED Strips and PCB 20mm

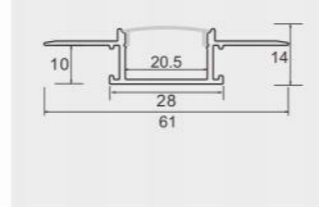

塑料堵头  
plastic end cap



## 2013单花边

产品参数

尺寸: Lx40x13mm  
材质: 6063-T5 铝合金  
表面: 氧化铝本色/喷漆 (黑色/白色)  
PC罩: 乳白/黑色/亚克力磨砂可选  
适用: 17.5MM软灯带/硬灯条

Description

size: Lx40x13mm  
Material: 6063-T5  
Surface: Silver / black / white Anodized  
PC cover: Milky white/black/acrylic matte  
Apply: LED Strips and PCB 17.5mm

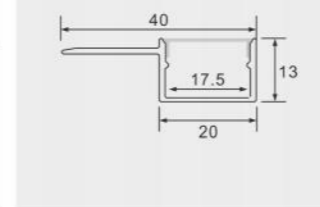

塑料堵头  
plastic end cap



## 2013上花边

产品参数

尺寸: Lx60x13mm  
材质: 6063-T5 铝合金  
表面: 氧化铝本色/喷漆 (黑色/白色)  
PC罩: 乳白/黑色/亚克力磨砂可选  
适用: 17.5MM软灯带/硬灯条

Description

size: Lx60x13mm  
Material: 6063-T5  
Surface: Silver / black / white Anodized  
PC cover: Milky white/black/acrylic matte  
Apply: LED Strips and PCB 17.5mm

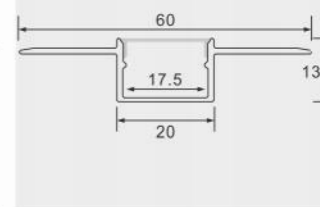

塑料堵头  
plastic end cap

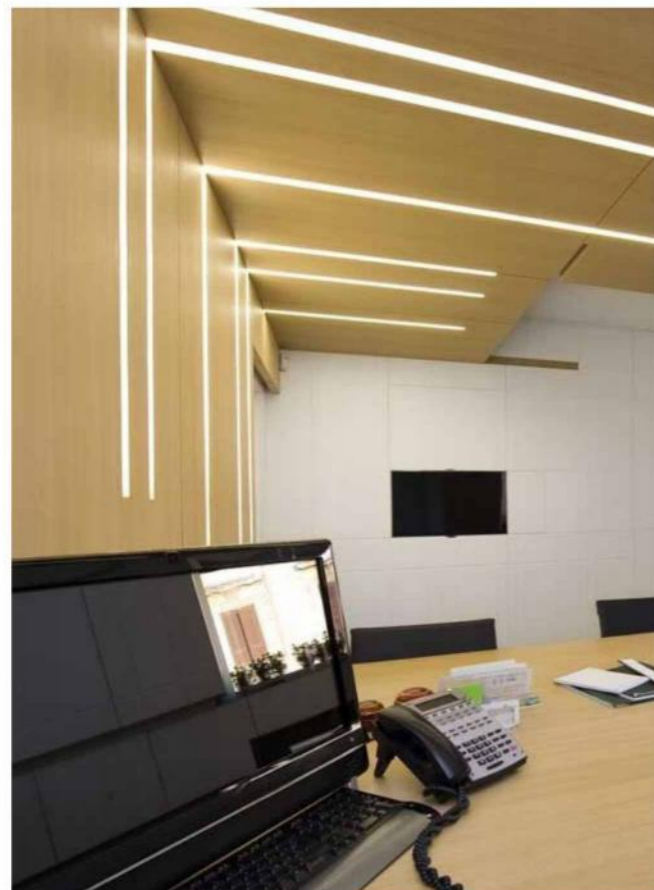

## 6114A

产品参数

尺寸: Lx61x14mm  
材质: 6063-T5 铝合金  
表面: 氧化铝本色/喷漆 (黑色/白色)  
PC罩: 乳白/黑色/亚克力磨砂可选  
适用: 20MM软灯带/硬灯条

Description

size: Lx61x14mm  
Material: 6063-T5  
Surface: Silver / black / white Anodized  
PC cover: Milky white/black/acrylic matte  
Apply: LED Strips and PCB 20mm

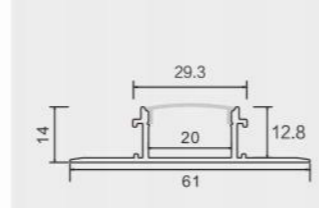

塑料堵头  
plastic end cap

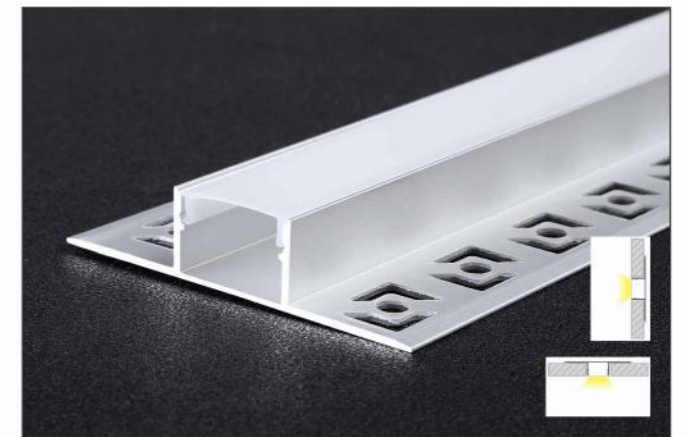

## 2013下花边

产品参数

尺寸: Lx60x13mm  
材质: 6063-T5 铝合金  
表面: 氧化铝本色/喷漆 (黑色/白色)  
PC罩: 乳白/黑色/亚克力磨砂可选  
适用: 17.5MM软灯带/硬灯条

Description

size: Lx60x13mm  
Material: 6063-T5  
Surface: Silver / black / white Anodized  
PC cover: Milky white/black/acrylic matte  
Apply: LED Strips and PCB 17.5mm

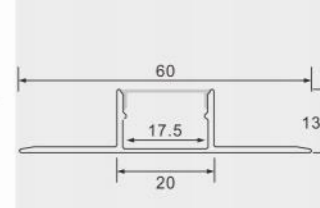

塑料堵头  
plastic end cap



## 3020单花边

**产品参数**  
尺寸: Lx50x20mm  
材质: 6063-T5 铝合金  
表面: 氧化铝本色/喷漆 (黑色/白色)  
PC罩: 乳白/黑色/亚克力磨砂可选  
适用: 28MM软灯带/硬灯条

**Description**  
size: Lx50x20mm  
Material: 6063-T5  
Surface: Silver / black / white Anodized  
PC cover: Milky white/black/acrylic matte  
Apply: LED Strips and PCB 28mm

塑料堵头  
plastic end cap

## 3020上花边

**产品参数**  
尺寸: Lx70x20mm  
材质: 6063-T5 铝合金  
表面: 氧化铝本色/喷漆 (黑色/白色)  
PC罩: 乳白/黑色/亚克力磨砂可选  
适用: 28MM软灯带/硬灯条

**Description**  
size: Lx70x20mm  
Material: 6063-T5  
Surface: Silver / black / white Anodized  
PC cover: Milky white/black/acrylic matte  
Apply: LED Strips and PCB 28mm

塑料堵头  
plastic end cap

## 9620

**产品参数**  
尺寸: Lx96x20mm  
材质: 6063-T5 铝合金  
表面: 氧化铝本色/喷漆 (黑色/白色)  
PC罩: 乳白/黑色/亚克力磨砂可选  
适用: 45MM软灯带/硬灯条

**Description**  
size: Lx96x20mm  
Material: 6063-T5  
Surface: Silver / black / white Anodized  
PC cover: Milky white/black/acrylic matte  
Apply: LED Strips and PCB 45mm

塑料堵头  
plastic end cap

# 踩地线条灯

## 铝型材套件

»»» P47-P49



2022  
NEW STYLE



## 632-1

### 产品参数

尺寸: Lx28x11mm  
材质: 6063-T5 铝合金  
表面: 氧化铝本色/喷漆 (黑色/白色)  
PC罩: 乳白/黑色/亚克力磨砂可选  
适用: 12MM软灯带/硬灯条

### Description

size: Lx28x11mm  
Material: 6063-T5  
Surface: Silver / black / white Anodized  
PC cover: Milky white/black/acrylic matte  
Apply: LED Strips and PCB 12mm

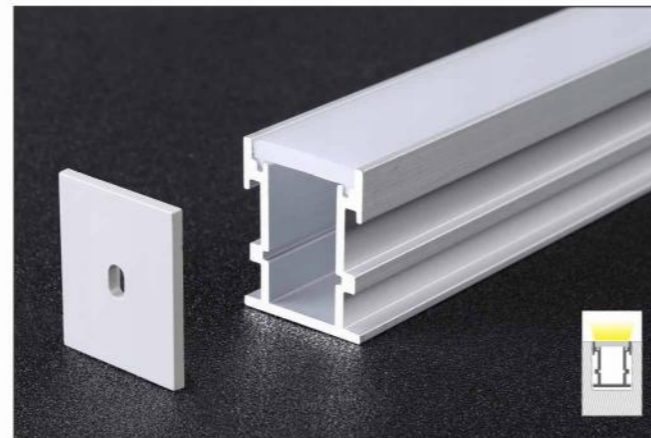
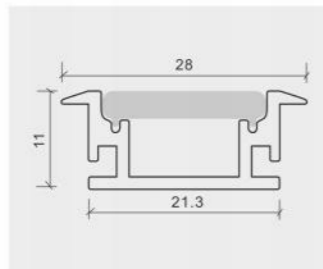

## 632

### 产品参数

尺寸: Lx21.3x25.8mm  
材质: 6063-T5 铝合金  
表面: 氧化铝本色/喷漆 (黑色/白色)  
PC罩: 乳白/黑色/亚克力磨砂可选  
适用: 12MM软灯带/硬灯条

### Description

size: Lx21.3x25.8mm  
Material: 6063-T5  
Surface: Silver / black / white Anodized  
PC cover: Milky white/black/acrylic matte  
Apply: LED Strips and PCB 12mm

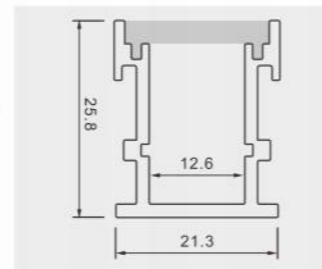

## 632A

### 产品参数

尺寸: Lx28x25.8mm  
材质: 6063-T5 铝合金  
表面: 氧化铝本色/喷漆 (黑色/白色)  
PC罩: 乳白/黑色/亚克力磨砂可选  
适用: 12MM软灯带/硬灯条

### Description

size: Lx28x25.8mm  
Material: 6063-T5  
Surface: Silver / black / white Anodized  
PC cover: Milky white/black/acrylic matte  
Apply: LED Strips and PCB 12mm

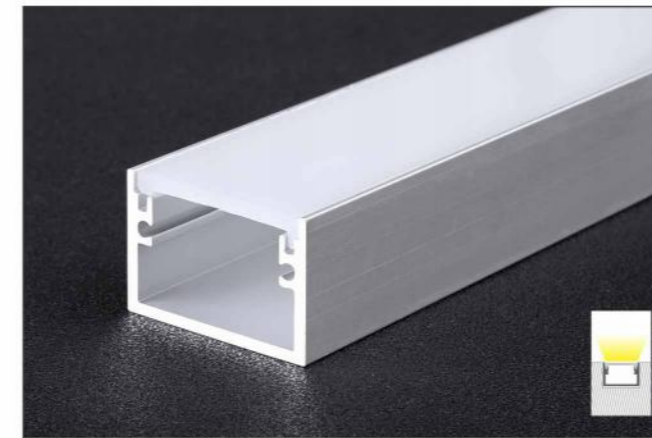
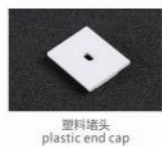
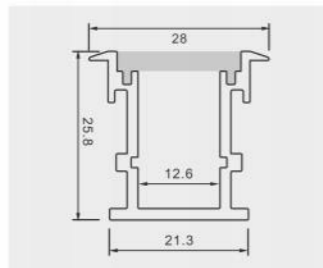

## 地踩3020M

### 产品参数

尺寸: Lx30x20mm  
材质: 6063-T5 铝合金  
表面: 氧化铝本色/喷漆 (黑色/白色)  
PC罩: 乳白/黑色/亚克力磨砂可选  
适用: 26MM软灯带/硬灯条

### Description

size: Lx30x20mm  
Material: 6063-T5  
Surface: Silver / black / white Anodized  
PC cover: Milky white/black/acrylic matte  
Apply: LED Strips and PCB 26mm

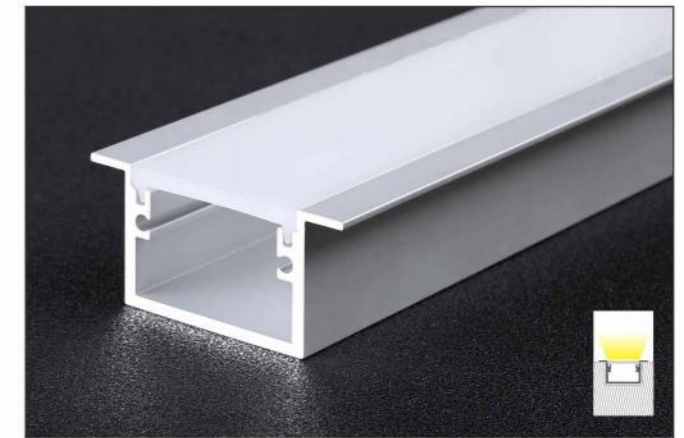
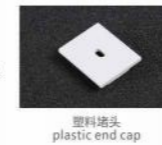
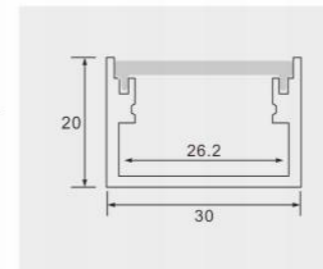

## 地踩3020A

### 产品参数

尺寸: Lx42x20mm  
材质: 6063-T5 铝合金  
表面: 氧化铝本色/喷漆 (黑色/白色)  
PC罩: 乳白/黑色/亚克力磨砂可选  
适用: 26MM软灯带/硬灯条

### Description

size: Lx42x20mm  
Material: 6063-T5  
Surface: Silver / black / white Anodized  
PC cover: Milky white/black/acrylic matte  
Apply: LED Strips and PCB 26mm

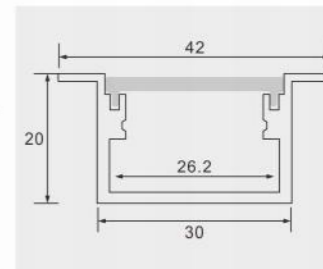

## 地踩5032M

### 产品参数

尺寸: Lx50x32.8mm  
材质: 6063-T5 铝合金  
表面: 氧化铝本色/喷漆 (黑色/白色)  
PC罩: 乳白/黑色/亚克力磨砂可选  
适用: 45MM软灯带/硬灯条

### Description

size: Lx50x32.8mm  
Material: 6063-T5  
Surface: Silver / black / white Anodized  
PC cover: Milky white/black/acrylic matte  
Apply: LED Strips and PCB 45mm

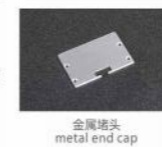
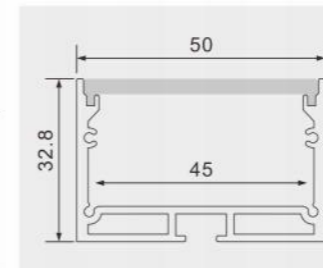

## 地踩5032A

### 产品参数

尺寸: Lx62.4x33mm  
材质: 6063-T5 铝合金  
表面: 氧化铝本色/喷漆 (黑色/白色)  
PC罩: 乳白/黑色/亚克力磨砂可选  
适用: 41MM软灯带/硬灯条

### Description

size: Lx62.4x33mm  
Material: 6063-T5  
Surface: Silver / black / white Anodized  
PC cover: Milky white/black/acrylic matte  
Apply: LED Strips and PCB 41mm

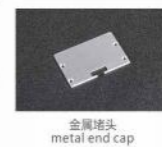
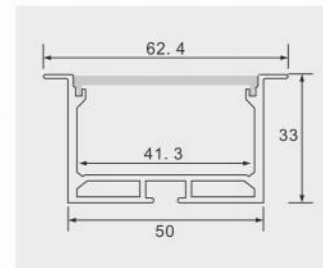

## 洗墙系列 铝型材套件

»» P50-P55



2022  
NEW STYLE

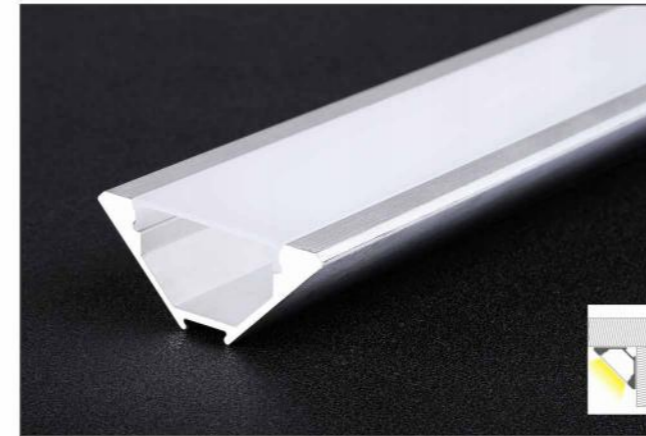

### 3030-L

产品参数

尺寸: Lx30x30mm  
材质: 6063-T5 铝合金  
表面: 氧化铝本色/喷漆 (黑色/白色)  
PC罩: 乳白/黑色/亚克力磨砂可选  
适用: 12MM软灯带/硬灯条

Description

size: Lx30x30mm  
Material: 6063-T5  
Surface: Silver / black / white Anodized  
PC cover: Milky white/black/acrylic matte  
Apply: LED Strips and PCB 12mm

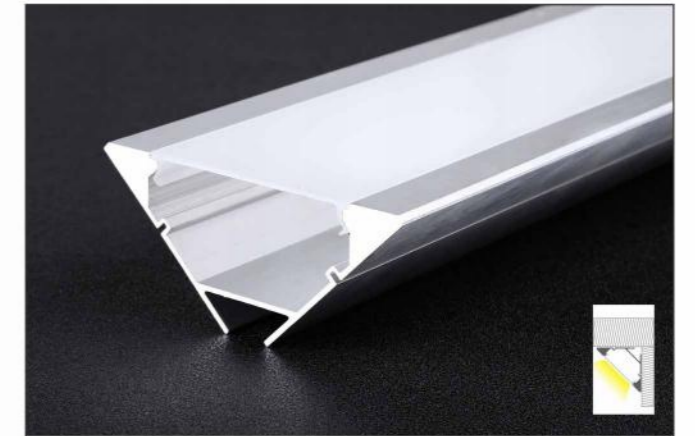
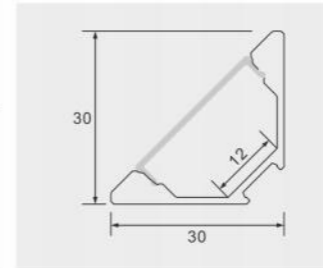

### 5050-L

产品参数

尺寸: Lx50x50mm  
材质: 6063-T5 铝合金  
表面: 氧化铝本色/喷漆 (黑色/白色)  
PC罩: 乳白/黑色/亚克力磨砂可选  
适用: 24MM软灯带/硬灯条

Description

size: Lx50x50mm  
Material: 6063-T5  
Surface: Silver / black / white Anodized  
PC cover: Milky white/black/acrylic matte  
Apply: LED Strips and PCB 24mm

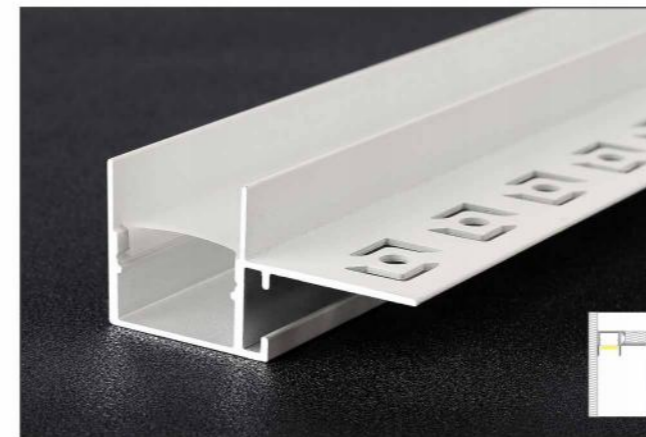
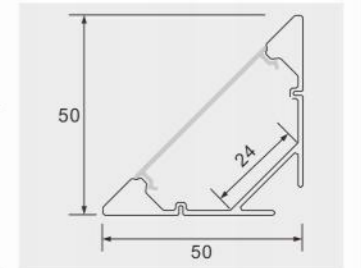

### 101

产品参数

尺寸: Lx43.8x21.3mm  
材质: 6063-T5 铝合金  
表面: 氧化铝本色/喷漆 (黑色/白色)  
PC罩: 乳白/黑色/亚克力磨砂可选  
适用: 17MM软灯带/硬灯条

Description

size: Lx43.8x21.3mm  
Material: 6063-T5  
Surface: Silver / black / white Anodized  
PC cover: Milky white/black/acrylic matte  
Apply: LED Strips and PCB 17mm

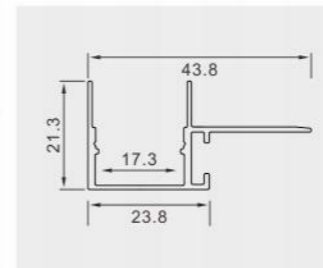

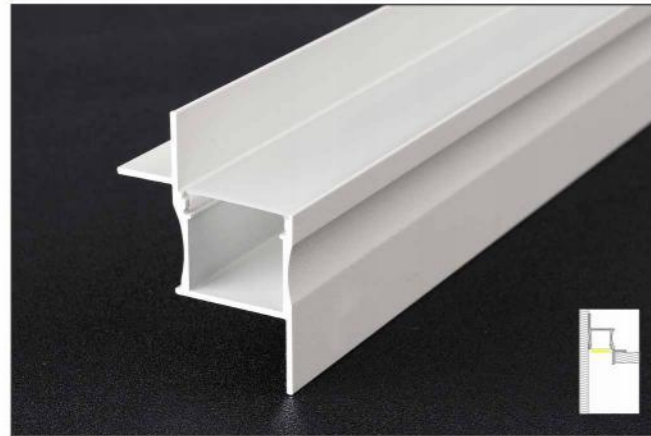

## 102

### 产品参数

尺寸: Lx37x50mm  
材质: 6063-T5 铝合金  
表面: 氧化铝本色/喷漆 (黑色/白色)  
PC罩: 乳白/黑色/亚克力磨砂可选  
适用: 20MM软灯带/硬灯条

### Description

size: Lx37x50mm  
Material: 6063-T5  
Surface: Silver / black / white Anodized  
PC cover: Milky white/black/acrylic matte  
Apply: LED Strips and PCB 20mm

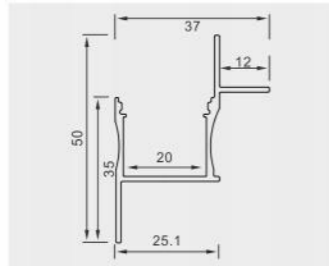

## 103

### 产品参数

尺寸: Lx45.2x50mm  
材质: 6063-T5 铝合金  
表面: 氧化铝本色/喷漆 (黑色/白色)  
PC罩: 乳白/黑色/亚克力磨砂可选  
适用: 20MM软灯带/硬灯条

### Description

size: Lx45.2x50mm  
Material: 6063-T5  
Surface: Silver / black / white Anodized  
PC cover: Milky white/black/acrylic matte  
Apply: LED Strips and PCB 20mm

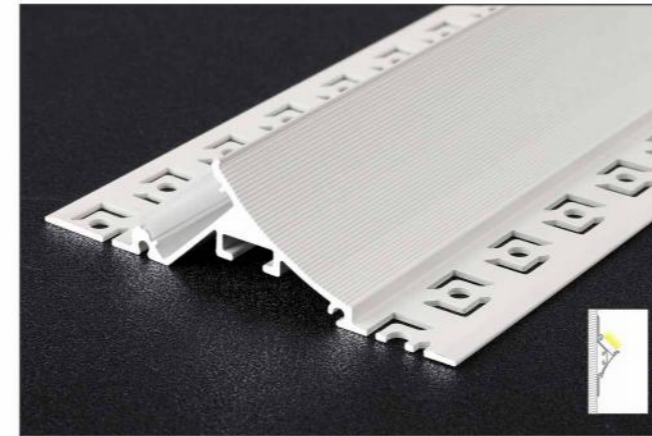
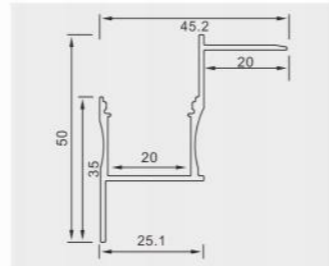

## 105

### 产品参数

尺寸: Lx86x23mm  
材质: 6063-T5 铝合金  
表面: 氧化铝本色/喷漆 (黑色/白色)  
PC罩: 乳白/黑色/亚克力磨砂可选  
适用: 21MM软灯带/硬灯条

### Description

size: Lx86x23mm  
Material: 6063-T5  
Surface: Silver / black / white Anodized  
PC cover: Milky white/black/acrylic matte  
Apply: LED Strips and PCB 21mm

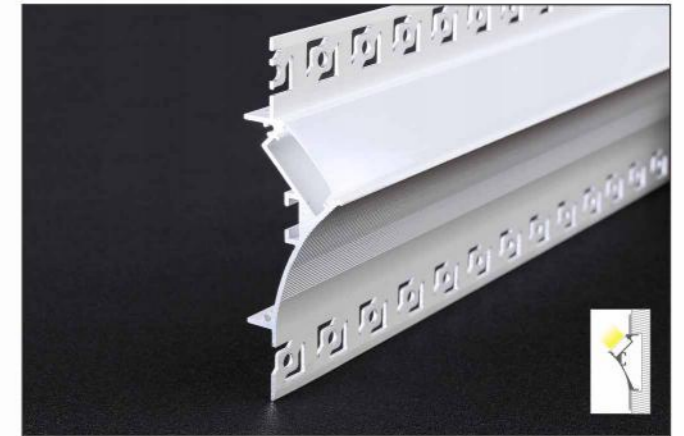
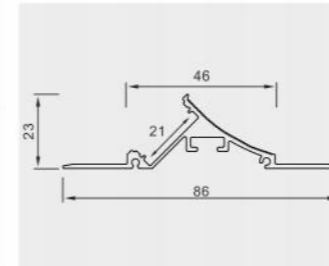

## 801

### 产品参数

尺寸: Lx95x30mm  
材质: 6063-T5 铝合金  
表面: 氧化铝本色/喷漆 (黑色/白色)  
PC罩: 乳白/黑色/亚克力磨砂可选  
适用: 21MM软灯带/硬灯条

### Description

size: Lx95x30mm  
Material: 6063-T5  
Surface: Silver / black / white Anodized  
PC cover: Milky white/black/acrylic matte  
Apply: LED Strips and PCB 21mm

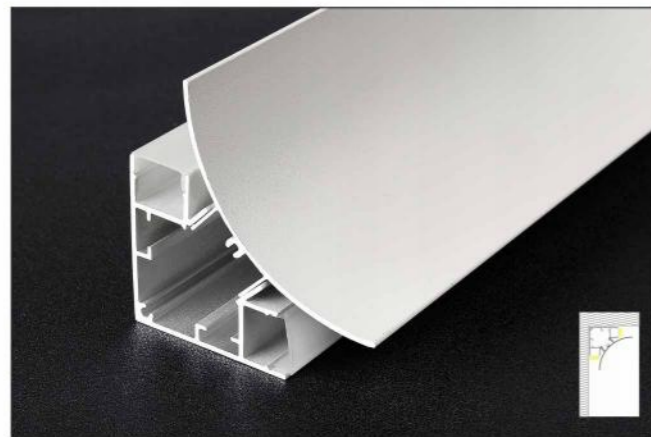
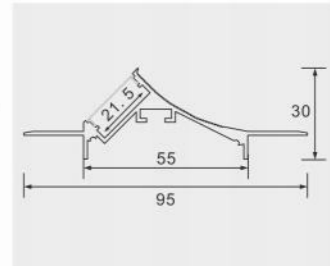

## 104

### 产品参数

尺寸: Lx60x60mm  
材质: 6063-T5 铝合金  
表面: 氧化铝本色/喷漆 (黑色/白色)  
PC罩: 乳白/黑色/亚克力磨砂可选  
适用: 12MM软灯带/硬灯条

### Description

size: Lx60x60mm  
Material: 6063-T5  
Surface: Silver / black / white Anodized  
PC cover: Milky white/black/acrylic matte  
Apply: LED Strips and PCB 12mm

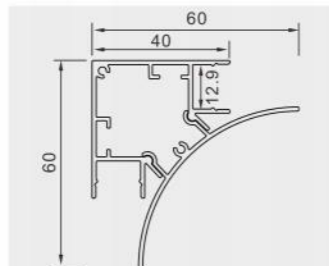

## 803

### 产品参数

尺寸: Lx96x15.3mm  
材质: 6063-T5 铝合金  
表面: 氧化铝本色/喷漆 (黑色/白色)  
PC罩: 乳白/黑色/亚克力磨砂可选  
适用: 12MM软灯带/硬灯条

### Description

size: Lx96x15.3mm  
Material: 6063-T5  
Surface: Silver / black / white Anodized  
PC cover: Milky white/black/acrylic matte  
Apply: LED Strips and PCB 12mm

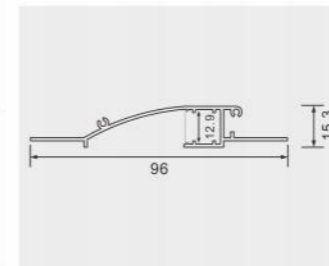



## 106

### 产品参数

尺寸: Lx78x70.3mm  
材质: 6063-T5 铝合金  
表面: 氧化铝本色/喷漆 (黑色/白色)  
PC罩: 乳白/黑色/亚克力磨砂可选  
适用: 10MM软灯带/硬灯条

### Description

size: Lx78x70.3mm  
Material: 6063-T5  
Surface: Silver / black / white Anodized  
PC cover: Milky white/black/acrylic matte  
Apply: LED Strips and PCB 10mm

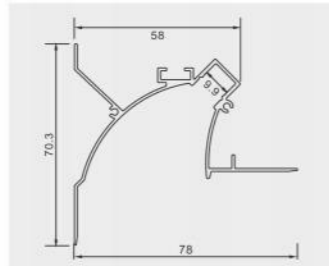

## 107

### 产品参数

尺寸: Lx88x50mm  
材质: 6063-T5 铝合金  
表面: 氧化铝本色/喷漆 (黑色/白色)  
PC罩: 乳白/黑色/亚克力磨砂可选  
适用: 10MM软灯带/硬灯条

### Description

size: Lx88x50mm  
Material: 6063-T5  
Surface: Silver / black / white Anodized  
PC cover: Milky white/black/acrylic matte  
Apply: LED Strips and PCB 10mm

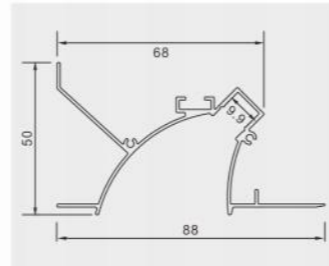

## 弧形花边

### 产品参数

尺寸: Lx88.5x58.6mm  
材质: 6063-T5 铝合金  
表面: 氧化铝本色/喷漆 (黑色/白色)  
PC罩: 乳白/黑色/亚克力磨砂可选  
适用: 21MM软灯带/硬灯条

### Description

size: Lx88.5x58.6mm  
Material: 6063-T5  
Surface: Silver / black / white Anodized  
PC cover: Milky white/black/acrylic matte  
Apply: LED Strips and PCB 21mm

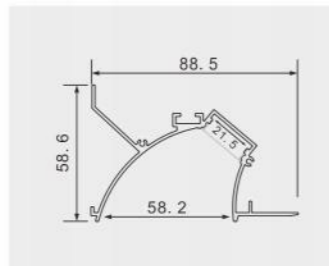

## 弧形预埋

### 产品参数

尺寸: Lx90.7x58.7mm  
材质: 6063-T5 铝合金  
表面: 氧化铝本色/喷漆 (黑色/白色)  
PC罩: 乳白/黑色/亚克力磨砂可选  
适用: 20MM软灯带/硬灯条

### Description

size: Lx90.7x58.7mm  
Material: 6063-T5  
Surface: Silver / black / white Anodized  
PC cover: Milky white/black/acrylic matte  
Apply: LED Strips and PCB 20mm

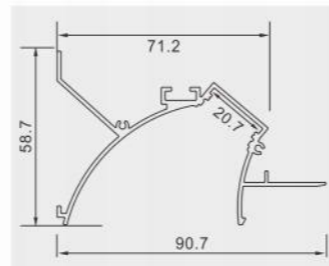

## 弧形花边加长款

### 产品参数

尺寸: Lx88.5x87mm  
材质: 6063-T5 铝合金  
表面: 氧化铝本色/喷漆 (黑色/白色)  
PC罩: 乳白/黑色/亚克力磨砂可选  
适用: 21MM软灯带/硬灯条

### Description

size: Lx88.5x87mm  
Material: 6063-T5  
Surface: Silver / black / white Anodized  
PC cover: Milky white/black/acrylic matte  
Apply: LED Strips and PCB 21mm

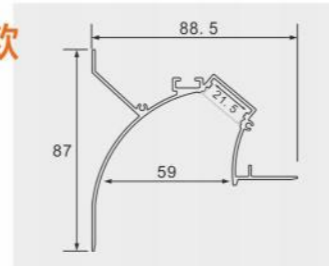

## 802

### 产品参数

尺寸: Lx95x38mm  
材质: 6063-T5 铝合金  
表面: 氧化铝本色/喷漆 (黑色/白色)  
PC罩: 乳白/黑色/亚克力磨砂可选  
适用: 21MM软灯带/硬灯条

### Description

size: Lx95x38mm  
Material: 6063-T5  
Surface: Silver / black / white Anodized  
PC cover: Milky white/black/acrylic matte  
Apply: LED Strips and PCB 21mm

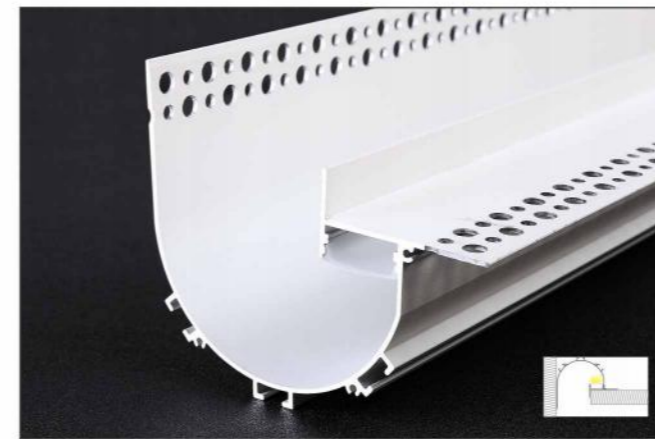
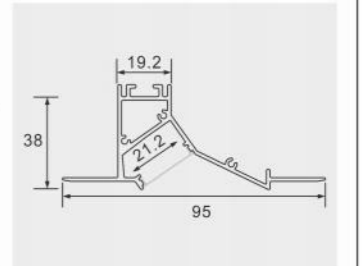

## 半圆回光槽

### 产品参数

尺寸: Lx101.4x86.5mm  
材质: 6063-T5 铝合金  
表面: 氧化铝本色/喷漆 (黑色/白色)  
PC罩: 乳白/黑色/亚克力磨砂可选  
适用: 21MM软灯带/硬灯条

### Description

size: Lx101.4x86.5mm  
Material: 6063-T5  
Surface: Silver / black / white Anodized  
PC cover: Milky white/black/acrylic matte  
Apply: LED Strips and PCB 21mm

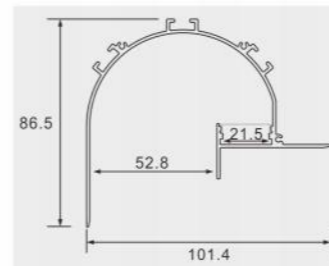



## 磁吸灯 铝型材套件

》》》 P56-P62



2022  
NEW STYLE



### 2.0批灰轨道

#### 产品参数

尺寸: Lx72x55mm  
材质: 6063-T5 铝合金  
表面: 喷漆/氧化 黑色  
适用: 2.0磁吸灯

#### Desciption

size: Lx72x55mm  
Material: 6063-T5  
Surface: Paint/oxidation black  
Apply: 2.0 Magnetic suction lamp

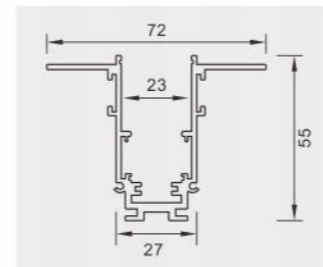

金属堵头  
metal end cap

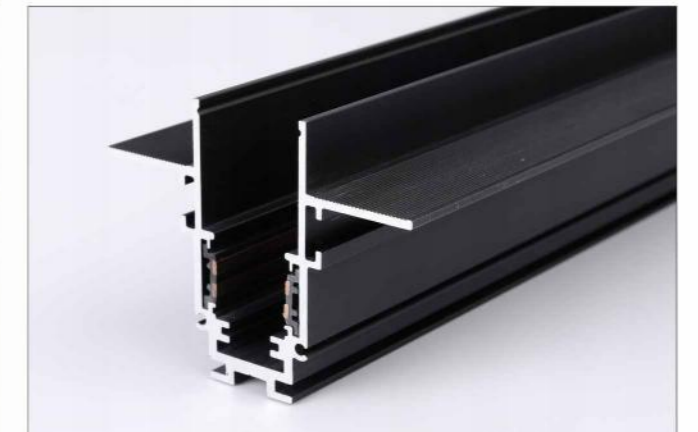

### 2.0暗装轨道

#### 产品参数

尺寸: Lx72x55mm  
材质: 6063-T5 铝合金  
表面: 喷漆/氧化 黑色  
适用: 2.0磁吸灯

#### Desciption

size: Lx72x55mm  
Material: 6063-T5  
Surface: Paint/oxidation black  
Apply: 2.0 Magnetic suction lamp

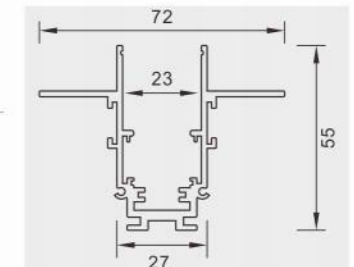

金属堵头  
metal end cap

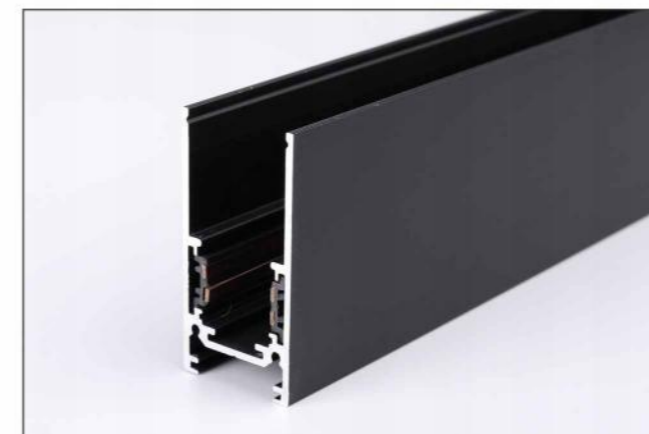

### 2.0明装轨道

#### 产品参数

尺寸: Lx27x53mm  
材质: 6063-T5 铝合金  
表面: 喷漆/氧化 黑色  
适用: 2.0磁吸灯

#### Desciption

size: Lx27x53mm  
Material: 6063-T5  
Surface: Paint/oxidation black  
Apply: 2.0 Magnetic suction lamp

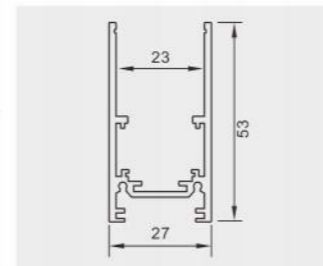

金属堵头  
metal end cap

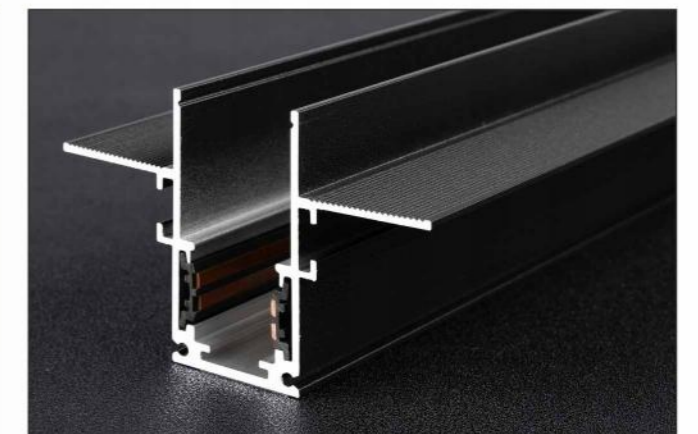

### CX-01

#### 产品参数

尺寸: Lx72x55mm  
材质: 6063-T5 铝合金  
表面: 喷漆/氧化 黑色  
适用: 2.0磁吸灯

#### Desciption

size: Lx72x55mm  
Material: 6063-T5  
Surface: Paint/oxidation black  
Apply: 2.0 Magnetic suction lamp

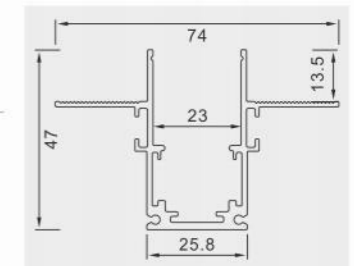

金属堵头  
metal end cap

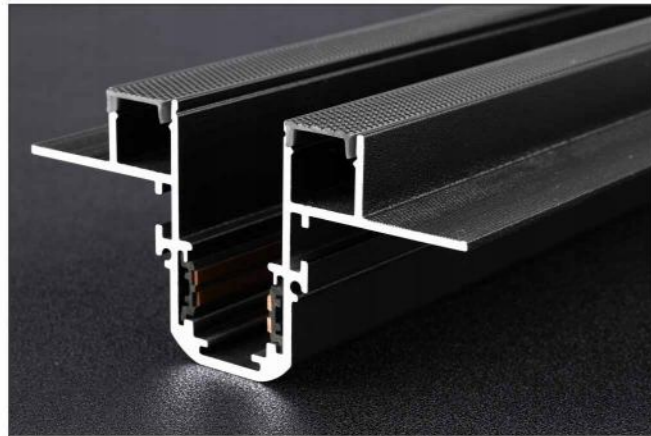

## 多发光轨道

### 产品参数

尺寸: Lx72x55mm  
材质: 6063-T5 铝合金  
表面: 喷漆/氧化 黑色  
适用: 2.0磁吸灯

### Description

size: Lx72x55mm  
Material: 6063-T5  
Surface: Paint/oxidation black  
Apply: 2.0 Magnetic suction lamp

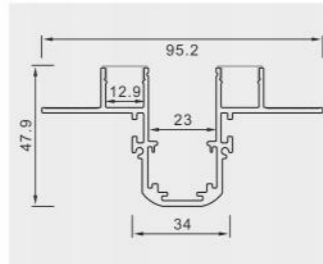

## 组合批灰轨道

### 产品参数

尺寸: Lx74.2x53mm  
材质: 6063-T5 铝合金  
表面: 喷漆/氧化 黑色  
适用: 2.0磁吸灯

### Description

size: Lx74x53mm  
Material: 6063-T5  
Surface: Paint/oxidation black  
Apply: 2.0 Magnetic suction lamp

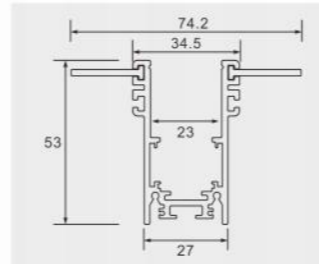

## 组合预埋轨道

### 产品参数

尺寸: Lx74.2x53mm  
材质: 6063-T5 铝合金  
表面: 喷漆/氧化 黑色  
适用: 2.0磁吸灯

### Description

size: Lx74x53mm  
Material: 6063-T5  
Surface: Paint/oxidation black  
Apply: 2.0 Magnetic suction lamp

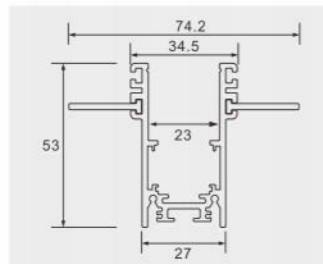

## 组合明装轨道

### 产品参数

尺寸: Lx34.5x53mm  
材质: 6063-T5 铝合金  
表面: 喷漆/氧化 黑色  
适用: 2.0磁吸灯

### Description

size: Lx74x53mm  
Material: 6063-T5  
Surface: Paint/oxidation black  
Apply: 2.0 Magnetic suction lamp

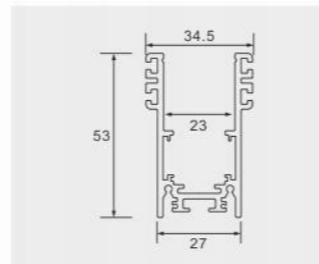

## 2.0批灰轨道水平转角

尺寸: Lx72x55mm  
角度: 90°  
材质: 6063-T5 铝合金  
表面: 喷漆/氧化 黑色  
适用: 2.0磁吸灯



## 2.0暗装轨道水平转角

尺寸: Lx72x55mm  
角度: 90°  
材质: 6063-T5 铝合金  
表面: 喷漆/氧化 黑色  
适用: 2.0磁吸灯



## 2.0明装轨道水平转角

尺寸: Lx27x53mm  
角度: 90°  
材质: 6063-T5 铝合金  
表面: 喷漆/氧化 黑色  
适用: 2.0磁吸灯



## 2.0批灰轨道垂直转角

尺寸: Lx72x55mm  
角度: 90°  
材质: 6063-T5 铝合金  
表面: 喷漆/氧化 黑色  
适用: 2.0磁吸灯



## 2.0暗装轨道垂直转角

尺寸: Lx72x55mm  
角度: 90°  
材质: 6063-T5 铝合金  
表面: 喷漆/氧化 黑色  
适用: 2.0磁吸灯



## 2.0明装轨道垂直转角

尺寸: Lx27x53mm  
角度: 90°  
材质: 6063-T5 铝合金  
表面: 喷漆/氧化 黑色  
适用: 2.0磁吸灯



泛光灯30CM

功率: 10W	颜色: 喷漆/氧化 黑色
磁吸泛光灯尺寸: 291*22*44MM	铝槽材质: 6063-T5
透镜: 达尔科透镜	堵头材质: 金属 颜色: 黑色
显指: 90	



泛光灯60CM

功率: 18W	颜色: 喷漆/氧化 黑色
磁吸泛光灯尺寸: 601*22*44MM	铝槽材质: 6063-T5
透镜: 达尔科透镜	堵头材质: 金属 颜色: 黑色
显指: 90	



轨道灯12瓦(圆)

功率: 12W	颜色: 喷漆/氧化 黑色
磁吸泛光灯尺寸: $\Phi 65$ *L190MM	铝槽材质: 压铸成型
透镜: 达尔科透镜	堵头材质: 金属 颜色: 黑色
显指: 90	



折叠灯6瓦

功率: 6W	颜色: 喷漆/氧化 黑色
磁吸泛光灯尺寸: 130*22*106MM	铝槽材质: 6063-T5
透镜: 达尔科透镜	堵头材质: 金属 颜色: 黑色
显指: 90	



格栅灯6瓦

功率: 6W	颜色: 喷漆/氧化 黑色
磁吸泛光灯尺寸: 130*22*44MM	铝槽材质: 6063-T5
透镜: 达尔科透镜	堵头材质: 金属 颜色: 黑色
显指: 90	



格栅灯12瓦

功率: 12W	颜色: 喷漆/氧化 黑色
磁吸泛光灯尺寸: 196*22*44MM	铝槽材质: 6063-T5
透镜: 达尔科透镜	堵头材质: 金属 颜色: 黑色
显指: 90	



折叠灯12瓦

功率: 12W	颜色: 喷漆/氧化 黑色
磁吸泛光灯尺寸: 231*22*106MM	铝槽材质: 6063-T5
透镜: 达尔科透镜	堵头材质: 金属 颜色: 黑色
显指: 90	



输入模块

尺寸: 530\*17\*17MM



格栅灯18瓦

功率: 18W	颜色: 喷漆/氧化 黑色
磁吸泛光灯尺寸: 291*22*44MM	铝槽材质: 6063-T5
透镜: 达尔科透镜	堵头材质: 金属 颜色: 黑色
显指: 90	



轨道灯7瓦(圆)

功率: 7W	颜色: 喷漆/氧化 黑色
磁吸泛光灯尺寸: $\Phi 50$ *L150MM	铝槽材质: 压铸成型
透镜: 达尔科透镜	堵头材质: 金属 颜色: 黑色
显指: 90	



直接模块

尺寸: 202\*17\*17MM



转角模块

尺寸: 368\*17\*17MM

软灯带光源



欧司朗灯珠软灯带  
电压: 直流DC12V / 24V(可选)  
功率: 15W/米  
灯珠: 2835 120珠/米  
宽度: 8mm  
长度: 5m/卷  
色温: 3000K/4000K/6000K  
显指: RA90

硬灯条光源

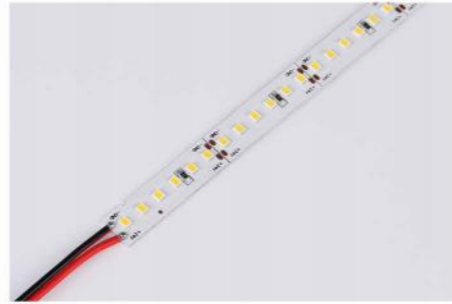

欧司朗灯珠硬灯条  
电压: 直流DC12V / 24V(可选)  
功率: 16W/米  
灯珠: 2835 144珠/米  
宽度: 12mm  
长度: 1000mm  
色温: 3000K/4000K/6000K  
显指: RA90

台湾明纬开关电源



LRS-35 恒压 12V/24V/48V



LRS-50 恒压 12V/24V/48V



LRS-75 恒压 12V/24V/48V



LRS-100 恒压 12V/24V/48V



LRS-150 恒压 12V/24V/48V



LRS-200 恒压 12V/24V/48V



LRS-350 恒压 12V/24V/48V

磁吸灯内置电源



KR-100瓦 恒压 48V



KR-200瓦 恒压 48V

转角配件



PC接头:509转角  
内空尺寸: 17.4\*7MM

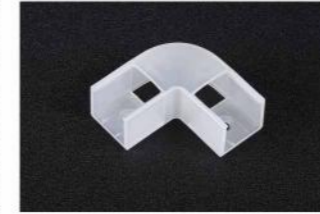

PC接头:613转角  
内空尺寸: 17.2\*14.4MM



PC接头:601转角  
内空尺寸: 15.8\*15.8MM

连接片

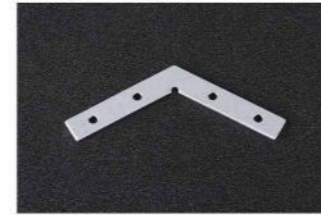

120度连接片  
50mm\*10mm\*2mm 内六角M4螺丝



135度连接片  
50mm\*10mm\*2mm 内六角M4螺丝

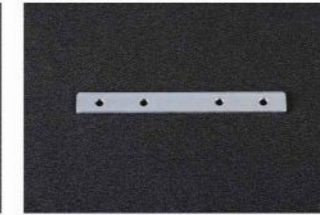

180度连接片  
100mm\*10mm\*2mm 内六角M4螺丝

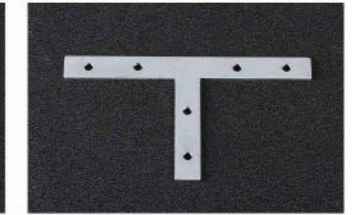

T字连接片  
100mm\*10mm\*2mm 内六角M4螺丝

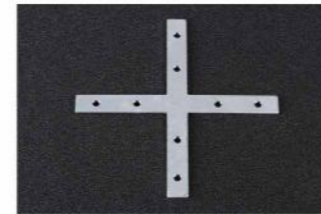

十字连接片  
100mm\*10mm\*2mm 内六角M4螺丝

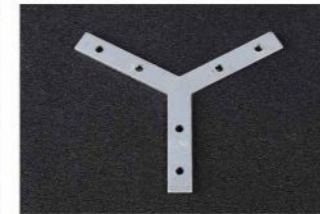

Y字连接片  
100mm\*10mm\*2mm 内六角M4螺丝



90度平拼连接片  
50mm\*10mm\*2mm 内六角M4螺丝



90度7字连接片  
50mm\*10mm\*2mm 内六角M4螺丝

吊线、卡扣、卡簧



王字卡扣(吸顶用)



吊线



单边卡簧(嵌装开孔用)



10公分卡簧(嵌装开孔用)



7公分卡簧(嵌装开孔用)



5公分卡簧(嵌装开孔用)



4公分卡簧(嵌装开孔用)



3公分卡簧(嵌装开孔用)