

TOP

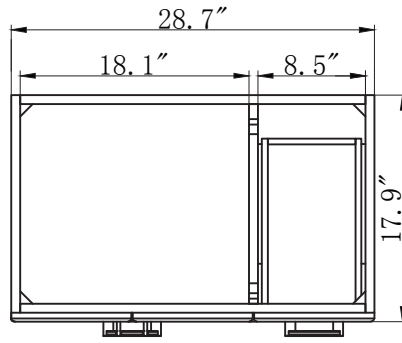

SIDE

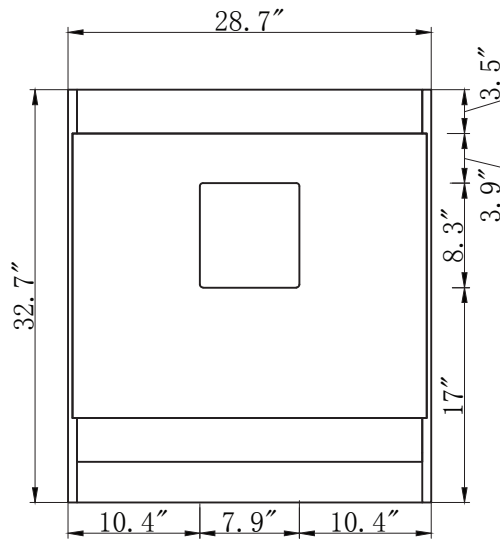
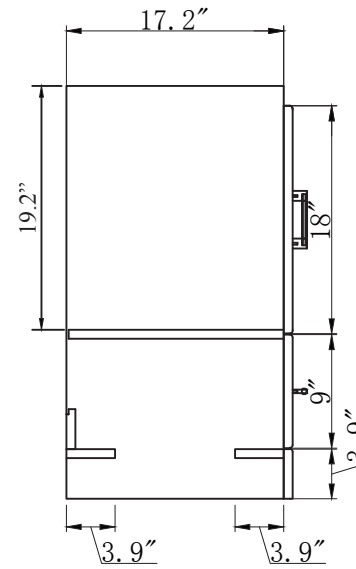

BACK

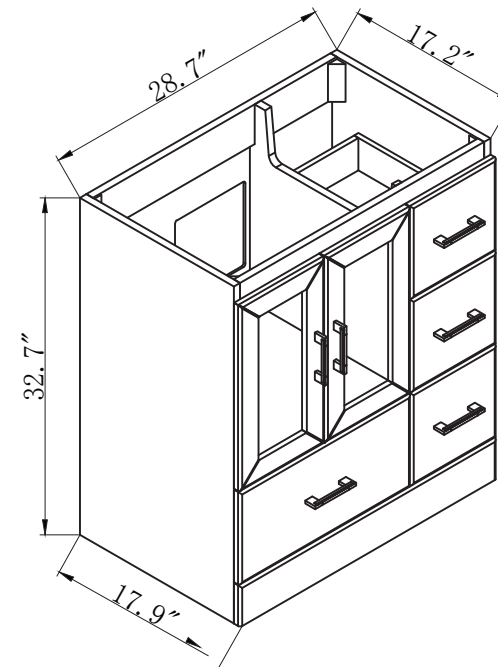

**AVANT**  
STYLES

**SPECIFICATIONS**

[www.avant-styles.com](http://www.avant-styles.com)

**SKU:** MS-6730

REV1.13.18

**NOTES**

Countertops are not shown in these diagrams. (Cabinet Only)  
Do not expose the surface of the cabinet to corrosive liquids or direct sunlight.  
All dimensions and specifications are approximate and subject to change without notice.