

*ROYAL***OTC**

Type: SUP060

# OPERATION AND MAINTENANCE

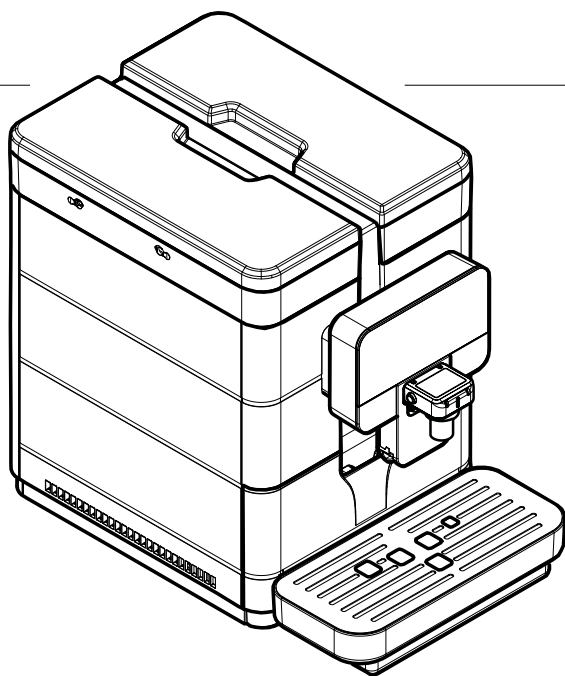

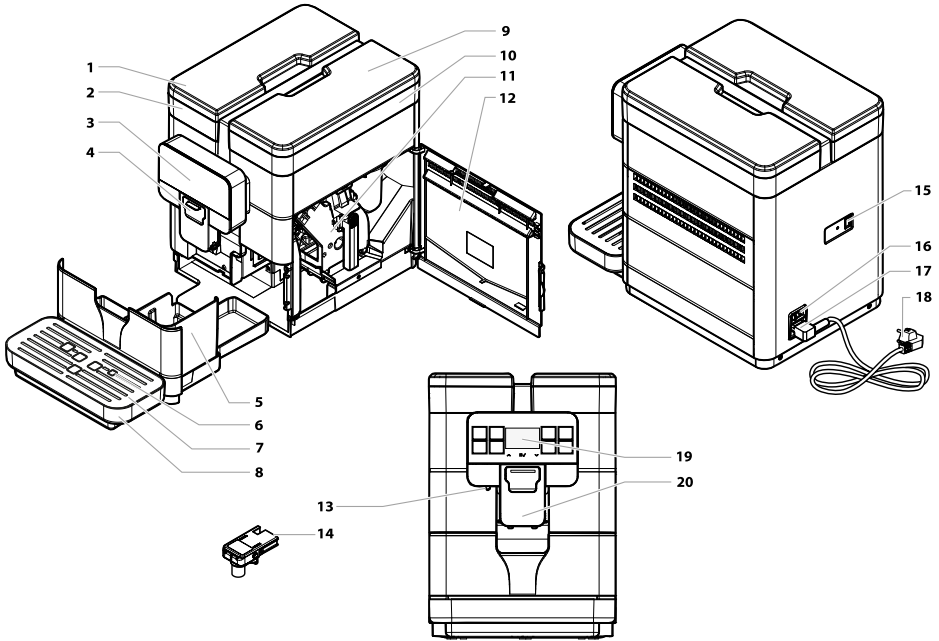







# MAIN PARTS



<b>1</b>	Water tank lid
<b>2</b>	Water tank
<b>3</b>	Touch control panel
<b>4</b>	Cappuccinatore compartment cover
<b>5</b>	Coffee grounds drawer
<b>6</b>	Full drip tray float
<b>7</b>	Cup holder grill
<b>8</b>	Drip tray
<b>9</b>	Coffee bean hopper lid
<b>10</b>	Coffee bean hopper

<b>11</b>	Brew group
<b>12</b>	Service door
<b>13</b>	Hot water dispensing spout
<b>14</b>	Cappuccinatore
<b>15</b>	USB port
<b>16</b>	Power button
<b>17</b>	Chassis plug
<b>18</b>	Power cord
<b>19</b>	Display
<b>20</b>	Moving coffee dispensing spout

## SAFETY INSTRUCTIONS

-  **Never allow water to come into contact with any of the electrical parts of the machine: danger of short circuit! Hot water and steam may cause scalding!**
-  The machine may be used by children older than 8 or by persons with reduced physical, mental or sensory abilities or lacking sufficient experience and/or skills, provided that they are supervised or instructed on how to use the appliance correctly and understand the hazards involved.
-  **Intended Use**
-  The machine is intended to be used in small offices/organisations only.
-  Do not make any technical changes or use the machine for unauthorised purposes since this would create serious hazards!
-  Children must not carry out any cleaning and maintenance operations without being monitored.
-  Children must not play with the appliance.
-  **Power Supply**
-  The machine must be connected to the power supply by the service provider, in accordance with its specifications.
-  **Power cord**
-  Never use power defective cords.

⚠ Report any defects in the cord and/or plug to the service provider immediately.

⚠ Do not pass the power cord around corners, over sharp edges or over hot objects and keep it away from oil.

⚠ If the power cord is damaged, it must be replaced by the manufacturer, its service centre or by adequately qualified personnel in order to avoid any risks.

⚠ Do not use the power cord to carry or pull the machine. Do not pull out the plug by the power cord or touch it with wet hands or feet.

⚠ Do not let the power cord hang freely from tables or shelves.

## ⚠ **Safety of Persons**

⚠ Ensure that children cannot play with the machine and/or the packaging materials.

## ⚠ **Danger of Burning**

⚠ Do not touch the hot water dispensing spout or the coffee/beverage dispensing spout.

## ⚠ **Fire Safety Precautions**

⚠ In case of fire, use carbon dioxide (CO<sub>2</sub>) extinguishers. Do not use water or dry powder extinguishers.

## ⚠ **Suitable Location for Operation and Maintenance**

⚠ The machine should be installed by the service provider in accordance with the safety regulations in force at the time of installation.



- ⚠ The machine may only be moved by the service provider.
- ⚠ Do not use the machine outdoors.
- ⚠ Do not install the machine in a location where water jets may be used.
- ⚠ Do not use open flames and/or incandescent objects near the machine so as not to damage or melt the machine housing.
- ⚠ Do not use the coffee machine in an environment with temperature values lower and/or equal to 2°C or higher than 32°C; If the machine has been exposed to such conditions, alert the service provider, who will carry out a safety check.
- ⚠ The appliance must be installed on a horizontal surface.
- ⚠ The machine must only be installed in places where it can be checked by qualified staff.
- ⚠ **Cleaning the machine**
- ⚠ Before cleaning the machine, switch OFF (0) the power button and the remove the plug from the power socket. Wait for the machine to cool down.
- ⚠ Never immerse the machine in water!
- ⚠ It is strictly forbidden to tamper with the internal parts of the machine.
- ⚠ Do not clean the machine using jets of water.
- ⚠ The appliance and its parts should be cleaned and washed following a period of inactivity.

## **Using Milk**

 Milk must be used and stored in accordance with the instructions given on the manufacturer's original packaging.

 We accept no liability for use of milk unsuitable for human consumption.

 Milk must be kept cold, as high temperatures will make it turn sour - this is a natural characteristic of milk. For this reason, the Cappuccinatore must be cleaned after each use, as described in the manual.

## **Storing the Machine**

 When the machine will not be used for a long period of time, turn it off and unplug it from the outlet.

 Store the machine in a dry place, out of the reach of children. Keep it protected from dust and dirt.

## **Servicing / Maintenance**

 In case of failures, defects or suspected faults resulting from a fall, immediately unplug the machine from power socket and alert the service provider or specialised technician.

 Never attempt to operate the machine if it is faulty.

 Only the service provider and/or technician may service or repair the machine.

 Only skilled and experienced people - with particular reference to safety and hygiene - are allowed to access the service area.

# CONTENTS

<b>1 INTRODUCTION TO THE MANUAL... 8</b>	
1.1 Preamble.....	8
1.2 Icons Used.....	8
<b>2 INFORMATION ABOUT THE..... 10</b>	
<b>APPLIANCE.....</b>	
2.1 Information for the Maintenance Technician.....	10
2.2 Description and Intended Use.....	10
2.3 Appliance Identification.....	11
2.4 Technical Specifications.....	12
<b>3 SAFETY..... 13</b>	
3.1 Preamble.....	13
3.2 General Safety Instructions.....	13
3.3 Operator Requirements.....	14
<b>4 HANDLING AND STORAGE..... 15</b>	
4.1 Unloading and Handling.....	15
4.2 Storage.....	15
<b>5 INSTALLATION..... 16</b>	
5.1 Cautions.....	16
5.2 Unpacking and Positioning.....	17
5.3 Connection to the Electric Network.....	19
<b>6 DESCRIPTION OF CONTROLS..... 20</b>	
6.1 Power button.....	20
6.2 Display.....	20
6.3 Keypad.....	20
6.4 Button Description during Normal Operation	20
<b>7 SUPPLY AND START UP..... 22</b>	
7.1 Coffee Blends.....	22
7.2 Coffee Bean Supply.....	22
7.3 Filling the Water Tank.....	23
7.4 Measuring and Adjusting Water Hardness..	24
7.5 Water filter.....	25
7.6 Coffee Grind Adjustment.....	27
7.7 Adjusting the "Aroma" - Amount of Ground... Coffee.....	28
7.8 Adjusting the Coffee Dispensing Spout.....	29
7.9 Turning on/off the machine.....	30
7.10 Setting the Language (Upon First Use).....	30
7.11 First Use - Use after a Long Period of..... Inactivity.....	31
7.12 Washing the Parts coming into Contact with Food.....	32
7.13 Using the Appliance.....	32
<b>8 PROGRAMMING MENU..... 33</b>	
8.1 Button Description in Programming Mode....	33
8.2 User Programming.....	34
8.3 Technical Programming.....	36
<b>9 OPERATION AND USE..... 46</b>	
9.1 Warm-up and Rinsing.....	46
9.2 Rinse/Self-Cleaning Cycle.....	47
9.3 Eco-friendly: Stand-by.....	47
9.4 Brewing Coffee.....	47
9.5 Cappuccinatore.....	48
9.6 Brewing Cappuccino.....	49
9.7 Brewing Latte Macchiato.....	51
9.8 Milk dispensing.....	52
9.9 Dispensing hot water.....	53
9.10 Adjusting Brewed Products.....	54
9.11 Using the Machine with Credits.....	56
9.12 Emptying the coffee grounds drawer and... drip tray.....	56
9.13 BLUETOOTH.....	57
<b>10 CLEANING AND MAINTENANCE..... 59</b>	
10.1 General Notes for Correct Operation.....	59
10.2 Cleaning and Scheduled Maintenance.....	60
<b>11 TROUBLESHOOTING..... 74</b>	
11.1 Warning signals.....	74
11.2 Problems - Causes - Solutions.....	77
<b>12 STORAGE - DISPOSAL..... 78</b>	
12.1 Location Change.....	78
12.2 Inactivity and Storage.....	78
<b>13 INSTRUCTIONS FOR END OF..... 79</b>	
<b>OPERATIONAL LIFE DISPOSAL.....</b>	

# I INTRODUCTION TO THE MANUAL

## I.1 Preamble

 This publication is an integral part of the machine and has to be read carefully to ensure its correct use in accordance with the essential health and safety requirements.

 This manual contains the technical information necessary to properly perform the operating, installation, cleaning and maintenance procedures.

 Always refer to this manual before carrying out any operation.

This article is marketed under the responsibility of SaGa Coffee S.p.A. which guarantees the product. Saeco is a registered trademark of Koninklijke Philips N.V. and its use is licensed by Koninklijke Philips N.V.

 This publication should be carefully kept with the machine throughout its service life, including transfers of ownership.

 The manufacturer reserves the right to make changes without prior notice.

## I.2 Icons Used

Various kinds of warnings are contained in this manual to highlight the different hazard or competence levels.

Each icon is followed by a message suggesting operating and behaviour procedures and providing useful information for the correct operation of the machine.

### Warning

It is used to highlight danger situations for the persons in charge of using, refilling and servicing the machine.

### Prohibition

It is used to highlight actions/operations not to be performed.

### Important

It is used to indicate operations that, if correctly performed, preserve machine performance.



## Suggested solutions

It is used to indicate alternative procedures which make programming and/or maintenance operations quicker.



## User

It is used to indicate the user of the machine. Users are not allowed to perform any cleaning or maintenance operations.



## Supply operator

It is used to indicate those operations that must be performed only by the person in charge of refilling and cleaning the machine.

Supply operators can not perform any operations requiring a Maintenance Technician.



## Maintenance technician

It is used to signal those operations that must be performed only by the specialised maintenance technicians.

## 2 INFORMATION ABOUT THE APPLIANCE

### 2.1 Information for the Maintenance Technician

 The appliance must be installed in a well-lit, sheltered and dry place and on a table suitable to bear its weight.

To ensure its correct operation and reliability over time, comply with the following recommendations:

- ambient temperature: from +2°C to +32°C;
- maximum humidity allowed: 80% (non-condensed).

For special installations, not covered by this manual, please contact the dealer or the local importer. If this is not possible, please contact the Manufacturer.

The technical service is available for any explanation or information regarding the correct operation of the machine and to satisfy any request for spare parts supply or technical assistance.

The Maintenance Technician must carefully read and observe the safety warnings contained in this manual to ensure that installation, start-up, use and maintenance operations are performed in complete safety.

This manual is an essential part supplied with the machine and should always be available for reference before any operation on the machine.

### 2.2 Description and Intended Use

This machine is automatically used to brew:

- coffee and espresso coffee using instantly ground coffee beans;
- hot beverages using hot water dispensed via the dispensing spout.
- milk-based beverages using the Cappuccinatore supplied.

The elegant machine housing has been designed for use in small offices, businesses and institutions.

Using the machine for any other purpose is considered dangerous and as a misuse.

 Misuse voids all forms of warranty, releasing the Manufacturer from any responsibility for damage to property and/or personal injury.

 The following are also considered misuse:

- any use other than the intended use and/or employing methods other than those described in this manual;
- any operation on the machine in breach of the instructions provided in this manual;
- any tampering with parts and/or safety devices not previously authorised by the Manufacturer and performed by unauthorised personnel;
- machine installation in an outdoor environment.

In such cases the customer will be charged with the machine repair cost.

## 2.3 Appliance Identification

The appliance is identified by the model name and serial number shown on the special plate.

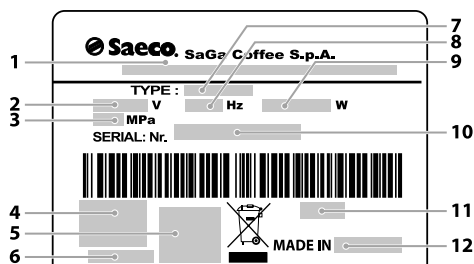

1	Name of the Manufacturer
2	Supply voltage (V)
3	Water mains pressure
4	Marks of conformity
5	Certifying organization
6	appliance code.
7	Model
8	Supply frequency (Hz)
9	Electrical power consumption (W)
10	Serial number
11	Year and month of manufacture
12	Country of manufacture

 It is strictly forbidden to tamper with or modify the data plate.

 When contacting the technical service, always refer to this plate by indicating the technical data shown on it.

## 2.4 Technical Specifications

Size (w x h x d)	280 x 398 x 460 mm	
Weight	approx. 10 kg	
Machine housing material	Thermoplastic material	
Power Rating	See the data plate	
Supply Voltage	See the data plate	
Power cord length	approx. 1,200 mm	
Capacity	Water tank	approx. 2.5 litres
	Coffee grounds drawer	18 grounds
Control panel	Front panel	
A-weighted sound pressure level	less than 70 dB	
Pump pressure	Max. 1.5 MPa (15.0 bar)	
Operating conditions	Minimum temperature: above 2°C Maximum temperature: less than 32°C Maximum humidity: less than 80%	
Safety devices	Boiler pressure safety valve Safety thermostat	

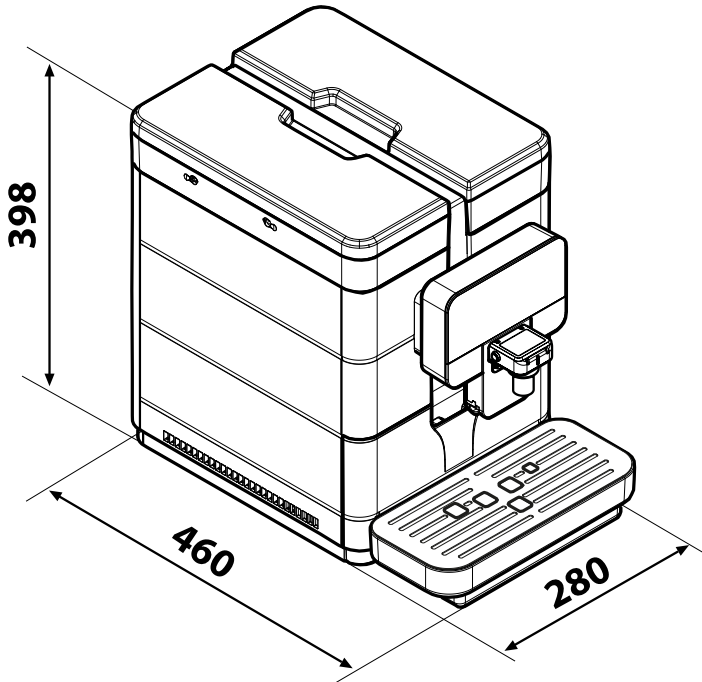

Subject to engineering and manufacturing changes due to technological improvements.



## 3 SAFETY

### 3.1 Preamble

In compliance with the regulations and directives in force, SaGa Coffee has established at its offices a technical pamphlet relative to the ROYAL appliance.

### 3.2 General Safety Instructions

#### It is forbidden to:

- tamper with or disable the safety systems installed on the machine;
- service the machine prior to unplug the power cord;
- install the appliance outdoors. It is advisable to place it in a dry place where the temperature does not drop below 2°C, in order to prevent any possible freezing.
- use the appliance for purposes other than those indicated in the sale contract and in this manual;
- electrically connect the appliance using multi-sockets or adapters;
- immerse the appliance in the water;
- use jets of water for cleaning operations.

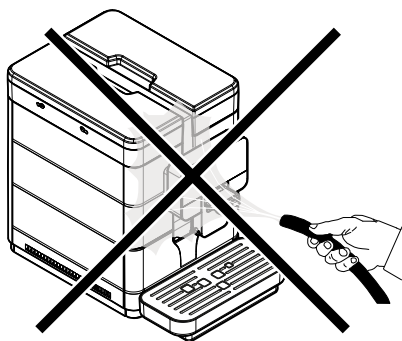



#### It is mandatory to:

- check conformity of the power supply;
- use original spare parts;
- carefully read the instructions contained in this manual and in the attached documents;
- use personal protective equipment when performing installation, testing and maintenance operations.

#### Precautionary measures to prevent human errors:

- make the operator aware of safety issues;
- handle the appliance, either packaged or unpackaged, in complete safety;
- deeply know the installation procedures, its correct operation and its limits;
- dismantle the appliance in complete safety, in accordance with the workers' health and environmental protection regulations in force.

 To prevent machining residues from coming into contact with the beverages, dispense about 0.5 l of water for each dispensing path before definitely starting the appliance. The dispensed beverages can be drunk only after performing this operation.

 In case of failure or malfunctioning, please refer only to the qualified personnel of the technical service.

 The manufacturer is not liable for damage to persons or property resulting from failure to follow the safety instructions provided in this section.

 Maintenance technician

The maintenance technician is the only person authorised to service the machine, start the programming procedures and perform the adjustment, set up and maintenance operations.

 Access to the internal area is restricted to persons having knowledge and practical experience of the appliance, in particular as far as safety and hygiene are concerned.

### 3.3 Operator Requirements

Three operators with different skills are required in order to guarantee the appliance's safety:

 User

The user is not allowed to access the internal parts of the machine.

 Supply operator

Only the Maintenance Technician is in charge of refilling the machine with products, cleaning the outside of the appliance, turning it on and off.

 The Supply operator is not allowed to carry out operations indicated in this manual as competence of the Maintenance Technician.

## 4 HANDLING AND STORAGE

 All the operations described in this chapter must be performed exclusively by the service provider or a specialised technician, who shall organise all the operating steps and use only suitable means to ensure strict compliance with the safety regulations in force.

### 4.1 Unloading and Handling

Unloading from the transport vehicle and handling operations of the appliance must be carried out by qualified personnel only and using suitable equipment.

 The appliance must always be kept in upright position.

 Do not:

- drag the appliance;
- overturn or lay down the appliance during transport and handling;
- shake the appliance;
- lift the appliance by using ropes or cranes;
- leave the appliance exposed to bad weather, in humid areas or close to heat sources.

### 4.2 Storage

The machine is packed in cardboard and expanded polystyrene packaging.

If the appliance is not immediately installed, it shall be kept in a sheltered place according to the following instructions:

- the packaged appliance shall be stored in a closed, dry area at a temperature between 1°C and 40°C;
- maximum humidity below 90% (non-condensed);
- do not put other appliances or boxes on the appliance;
- in any case, it is good practice to protect the appliance from possible deposits of dust or other substances.

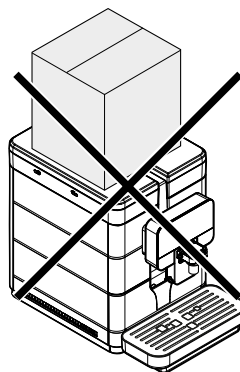

 Due to the total weight, do not stack more than three machines on top of each other. The machine should be stored in its original packaging, in a dry and/or dust-FREE place.

## 5 INSTALLATION

 All the operations described in this chapter must be performed exclusively by the service provider or a specialised technician, who shall organise all the operating steps and use only suitable means to ensure strict compliance with the safety regulations in force.

### 5.1 Cautions

 The appliance cannot be installed in external areas. Avoid placing it in areas where the temperature is lower than 2°C or higher than 32°C and in particularly humid or dusty places. It should neither be installed in places where water jets are used for cleaning operations nor where there is a risk of fire or explosion.

**Make sure that the installation place is compatible with the following specifications, before unpacking the appliance:**

- the power socket which the appliance is connected to should be easily accessible and at a distance not higher than 1.2 metres;
- the gradient of the supporting surface should NOT exceed 2°;
- the socket voltage must correspond to that indicated on the appliance data plate.

 The appliance must be installed on a horizontal surface.

⚠ The supporting surface must be adequate to bear the machine weight and clean.

⚠ Access to the machine and the plug should be kept clear at all times in order to allow users to easily reach them and to leave the area immediately if required.

⚠ The presence of magnetic fields or proximity to electrical machines which generate interference could cause the electronic controls of the machine to malfunction. At temperatures close to 0°C, internal parts containing water are at risk of freezing. Do not use the machine under these conditions.

The following illustration shows the required access distances:

- to the keypad on the front of the appliance;
- to the service units in the event of failure.

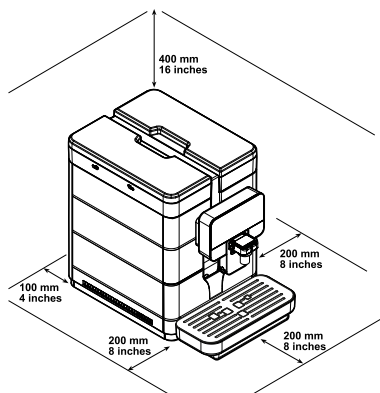

## 5.2 Unpacking and Positioning

On receipt of the appliance, make sure that it has not suffered any damage during transport or that the packaging has not been unduly opened with consequent stealing of the components contained in it. If damage of any kind is found, the courier must be informed and notice must be immediately given to the importer or to the seller. If these are not in the purchaser's country, please contact the manufacturing company directly. An accessories bag is supplied with the machine.

### List of Standard Accessories

Manual: instructions on how to use the machine.



Power cord: to connect the machine to the mains.



**Cappuccinatore:** allows you to dispense milk-based beverages.

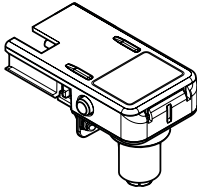

**Right-hand fitting for Cappuccinatore:** it allows you to connect the Cappuccinatore to the milk container on the right-hand side of the machine.

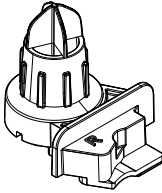

**Water hardness test:** quick test to determine the actual hardness of the water used to prepare beverages; this test is of fundamental importance to set the water hardness in the machine.

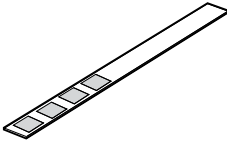

### List of Optional Accessories

**Cleaning brush:** to remove the coffee powder from the service compartment.

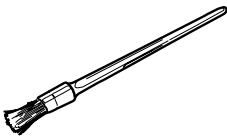

**Lubricating grease:** to lubricate the Brew Group at periodic intervals.

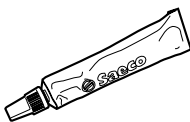

**"Intenza +" water filter:** to remove any unpleasant flavours in the water and reduce water hardness. This will improve machine use.



**Milk circuit cleaning powder:** allows a correct and thorough cleaning of the circuit, removing all possible milk residues.



**Group cleaning tablets:** allow a correct cleaning of the brew group, increasing its durability.



**Descaling solution:** to remove limescale build-up in the water circuit caused by normal use.



### 5.3 Connection to the Electric Network

⚠ This operation must only be performed by specialised technical personnel or by the service provider.

⚠ The Maintenance Technician, who is in charge of the appliance's installation, shall make sure that:

- the power supply system complies with the safety instructions in force;
- the voltage corresponds to that indicated on the appliance data plate.

⚠ In case of doubt, do not proceed with the installation and ask qualified and authorised personnel to accurately check the system.

⊘ Do not use adapters or multi-sockets.

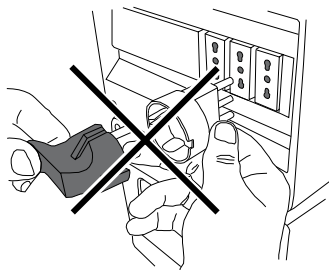

☞ Make sure that the power cord plug is easily reachable after installation.

## 6 DESCRIPTION OF CONTROLS

### 6.1 Power button

It is located in the lower left part in the rear of the machine. If set to the "I" position the machine turns on (electrical functions enabled). If set to the "O" position the machine turns off (electrical functions disabled).

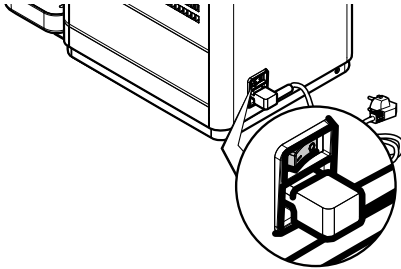

### 6.2 Display

The display shows the messages during normal operation and during the programming and maintenance phase.

### 6.3 Keypad

 The function of each key changes according to the change of the appliance phase (ordinary dispensing or programming phase).

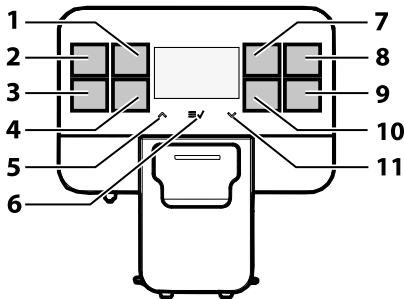

1	"Coffee" button
2	"Espresso" button
3	"Manual Brewing" button
4	"Hot Water" button
5	"Up" button
6	"MENU/OK" button
7	"Americano" button
8	"Cappuccino" button
9	"Latte Macchiato" button
10	"Milk" button
11	"Down" button

### 6.4 Button Description during Normal Operation

#### "Coffee" button

Press this button to start brewing a "coffee". Start the brewing of a "coffee x2" by pressing twice consecutively.

#### "Espresso" button

Press this button to start brewing an "espresso" coffee. Start the brewing of an "espresso x2" by pressing twice consecutively.

#### "Manual Brewing" button

When this button is pressed, a coffee product is brewed and the user is able to choose the length of the product.

#### "Hot Water" button

Press this button to dispense hot water.

#### "Up" button

Press this button to scroll up the user menu options.

#### "MENU/OK" button

Press this button to access the user menu, which allows you to perform a few machine washing cycles (brew group) and access the tech. menu. Once entered the menu, this button allows you to confirm the selected menu option.

If you hold down a button for approx. 3 seconds in a menu, you exit from all screens and return to the "machine-ready" screen.

#### "Americano" button

When this button is pressed, an American coffee is brewed.



**"Cappuccino" button**

When this button is pressed, a cappuccino is brewed.

**"Latte Macchiato" button**

When this button is pressed, a Latte Macchiato is brewed.

**"Milk" button**

Press this button to start dispensing Frothed Milk.

**"Down" button**

Press this button to scroll down the user menu options.



Each button is enabled upon re-activating the machine if it resumes operation from stand-by mode.

## 7 SUPPLY AND START UP

### 7.1 Coffee Blends

- We recommend using fresh, non-oily and medium-ground coffee.
- Use an espresso coffee blend.
- Use the special blends for espresso machines to obtain a strong and aromatic coffee.
- Keep coffee in a cool place in an airtight sealed container.

### 7.2 Coffee Bean Supply

 Only coffee beans must be put into the coffee bean hopper. Do not insert pre-ground coffee, instant coffee or any object that may damage the machine.

Remove the coffee bean hopper lid.

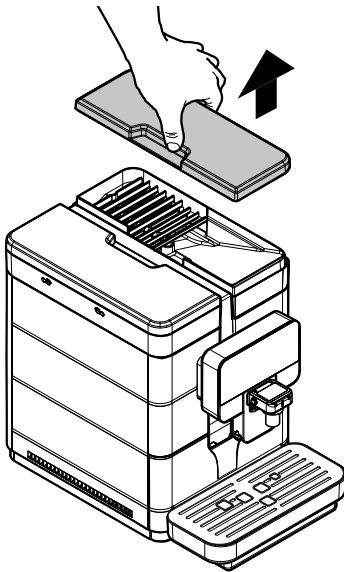

 The coffee bean hopper may be provided with different safety features according to the regulations of the country of use of the machine.

Pour the coffee beans into the hopper.

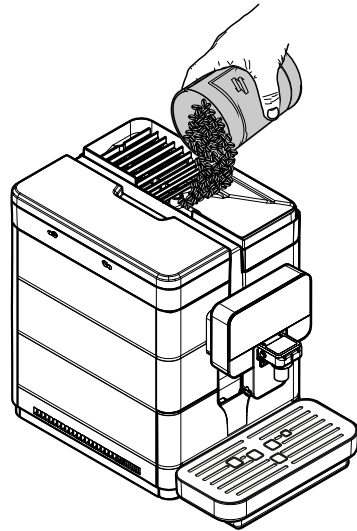

 When filling the coffee bean hopper, use sterile disposable gloves to prevent bacteriological contamination.

Refit the coffee bean hopper lid.

 If the water tank is not inserted, check that no coffee beans fall into the tank compartment. If this happens, remove them to avoid any malfunctions.

Remove the tank; lift it using the inside handles.

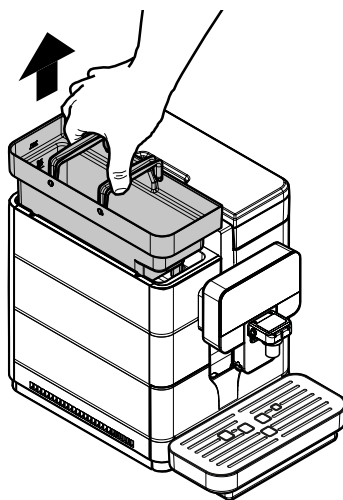

### 7.3 Filling the Water Tank

 Before using the machine for the first time, wash the water tank carefully. Fill the water tank with fresh drinking water only. Hot or carbonated water, as well as other liquids, will damage the machine.

Rinse and fill it with fresh water; do not exceed the level (MAX) indicated on the tank.

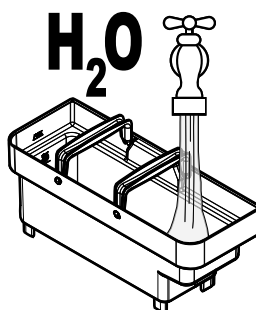

Remove the lid from the water tank.

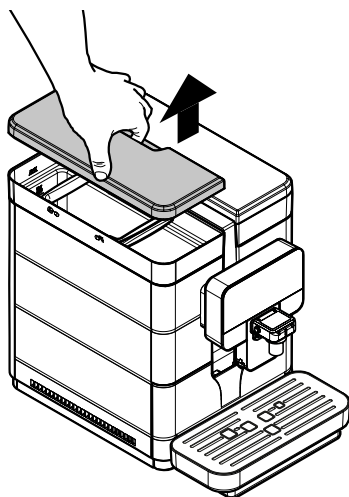

 When filling the water tank, use sterile disposable gloves to prevent bacteriological contamination.

Insert the water tank back into its seat and refit the lid.

## 7.4 Measuring and Adjusting Water Hardness

Measuring water hardness is very important in order to correctly manage the anti-scale filter and the frequency with which the machine must be descaled. Immerse the water hardness test strip in water for 1 second.

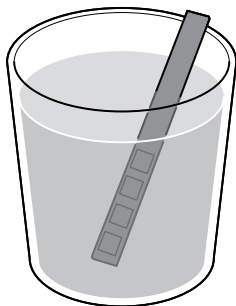

 the test strip is only valid for one measurement.

Check how many squares change their colour and then consult the table.

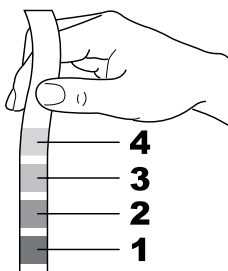

The numbers correspond to the settings indicated in the following machine adjustments.

1	HARDNESS 1 (very soft)
2	HARDNESS 2 (soft)
3	HARDNESS 3 (medium)
4	HARDNESS 4 (hard)

Switch to machine programming mode as described in section "Access to the Technical Menu".

Tech Menu
Settings
Statistics
Exit

Select the "SETTINGS" option and press the "OK" button.

Settings
Credits Menu
BEVERAGE SETTINGS
Machine Menu

To select the "MACHINE MENU" option, press the "DOWN" button.

Settings
Credits Menu
BEVERAGE SETTINGS
Machine Menu

Press the "OK" button to enter.

Machine Menu
General Menu
Display Menu
Water Menu

Press the "DOWN" button until the "WATER MENU" option is selected.

Machine Menu
General Menu
Display Menu
Water Menu

Press the "OK" button to enter.

Water Menu
Hardness
FILTER (0/8)
Exit

Press the "OK" button to enter the "HARDNESS" menu.

 The machine is supplied with standard adjustments, suitable for most uses.

Hardness
2
3
4

Press the "Up" button to increase the value or the "Down" button to decrease the value. Press the "OK" button to confirm the selected change.

After adjusting the water hardness, install the anti-scale filter as described in the following section.

## 7.5 Water filter

Water is a key element for a good espresso coffee. Therefore, it should always be filtered in a professional manner. This is why all machines can be equipped with a water filter. This filter is easy to use and its sophisticated technology is effective in preventing limescale build-up. This way, water will always be perfect and will give a much more intense aroma to your espresso coffee.

 Measuring water hardness is very important in order to correctly manage the water filter and the frequency with which the machine must be descaled.

 The anti-scale filter should be replaced whenever indicated by the machine.

 Before descaling, remove the anti-scale filter from the water tank.

Remove the water filter from its packaging. Set the filter in the standard position on letter B. Use the water hardness test strip (not provided with the machine). Set the "Intenza Aroma System" as specified on the filter package (see section "Measuring and Adjusting Water Hardness").

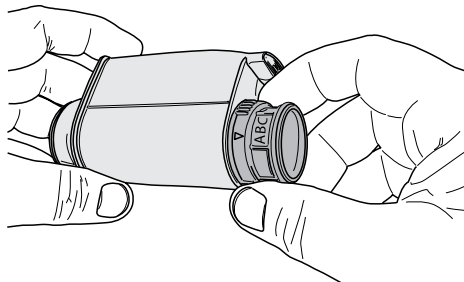

<b>A</b>	Soft water
<b>B</b>	Hard water (standard)
<b>C</b>	Very hard water.

Immerse the water filter vertically in cold water (with the opening positioned upwards) and gently press its sides to let the air bubbles out.

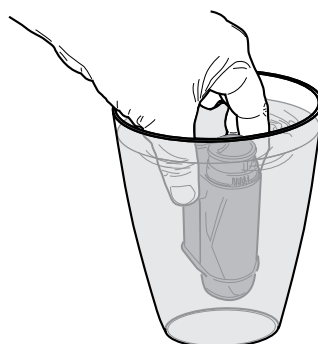

Switch to machine programming mode as described in section "Access to the Technical Menu".

Tech Menu
Settings
Statistics
Exit

Select the "SETTINGS" option and press the "OK" button.

Settings
Credits Menu
BEVERAGE SETTINGS
Machine Menu

To select the "MACHINE MENU" option, press the "DOWN" button.

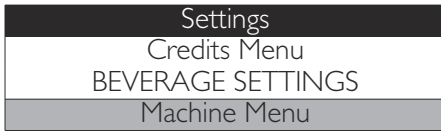

Press the "OK" button to enter.



Press the "DOWN" button until the "WATER MENU" option is selected.



Press the "OK" button to enter.



Press the "DOWN" button until you select the "FILTER (0/8)" option.



Press the "OK" button. The following screen is displayed:

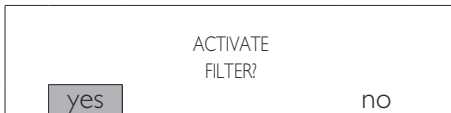

Remove the tank from the machine and empty it.

Remove the small white filter from the tank and store it in a dry place sheltered from dust.

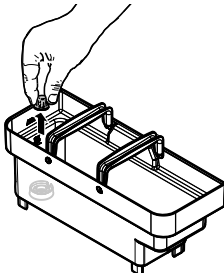

Select "YES" and press the "OK" button. The following screen is displayed:

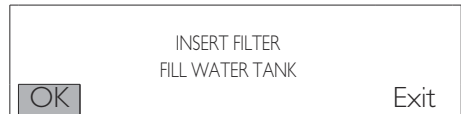

Put the filter into the empty tank. Press it to its limit stop.

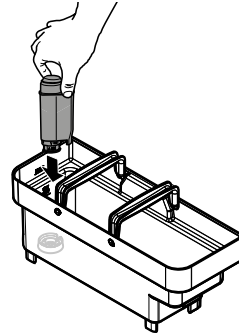

Fill the tank with fresh drinking water and reinsert it into the machine. Select "OK" and press the "OK" button. The following screen is displayed:



Place a container under the hot water dispensing spout. Select "OK" and press the "OK" button. The following screen is displayed:

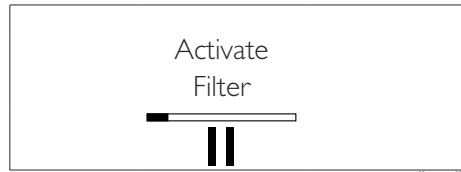

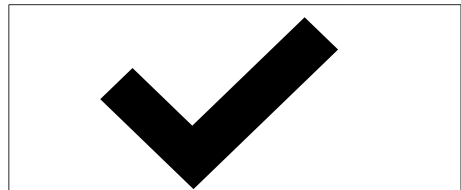

The filter activation phase starts. Press the "OK" button again to pause the operation. Once the operation is complete the machine exits the menu.



Fill the water tank again up to the MAX level with fresh drinking water. The Filter 100% icon appears on the machine-ready screen to indicate that the filter has been installed.



### 7.5.1 Replacing the water filter



-  Replace the water filter as soon as its capacity drops to 0% and the filter icon blinks quickly.
-  Replace the water filter at least every 3 months, even if the machine has not yet indicated the need to replace it.

Pull out the water filter. Follow the steps indicated in the "Water filter" section. Replace the filter and activate the new one. The display automatically updates the number of filters used. This datum is updated on the menu only if the user has installed a new filter before exhausting the previous one, or in any case, not exceeding the eighth filter in a row. Fill the water tank again up to the MAX level with fresh drinking water.

#### Replacing the Filter after Using 8 Filters

Pull out the water filter. Follow the steps indicated in the "Water filter" section. All operations relating to the descaling phase are requested as well. The display updates the number of used filters automatically, taking it to 0/8. However, only after descaling has finished and before the new filter activation. Fill the water tank again up to the MAX level with fresh drinking water.

## 7.6 Coffee Grind Adjustment

-  Do not pour ground and/or instant coffee into the coffee bean hopper. Do not put any material other than coffee beans into the hopper.
-  The coffee grinder contains moving parts that may be dangerous. Do not insert fingers and/or other objects.
-  Turn off the machine by pressing the ON/OFF button and remove the plug from the socket before carrying out any type of operation inside the coffee bean hopper.

The machine allows the coffee grind to be slightly adjusted in order to adapt it to the kind of coffee used. For any adjustments, use the lever located on the inner side of the service compartment.

Remove the drip tray.

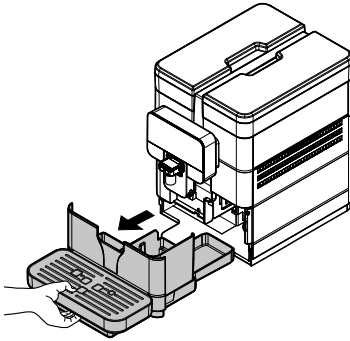

Remove the screw preventing accidental opening of the service compartment flap. (\* 120V USA version only).

Open the service compartment door and turn the lever by only one notch.

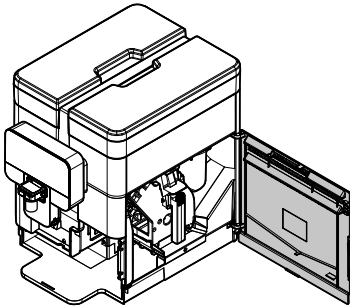

Close the door again and brew 1-2 cups of coffee to verify the changes in the grinding degree. Repeat the procedure until you reach the desired grind setting.

Re-insert the screw preventing accidental opening of the service compartment flap. (\* 120V USA version only).

The reference marks indicate the grind setting. There are different grind settings to choose from with the following references:

- 1 - Fine grind
- 2 - Coarse grind

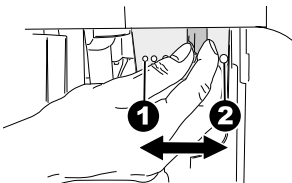

## 7.7 Adjusting the "Aroma" - Amount of Ground Coffee

The machine allows you to program the amount of coffee to be ground for preparing each cup of coffee.

**⚠** The Aroma adjusting lever must only be turned when the coffee grinder is stopped. The adjustment must be performed before brewing coffee.

**⚠** DO NOT change the coffee dose if the pre-grinding option is active (set on "ON").

For any adjustments, use the lever located on the inner side of the service compartment.

Extract the drip tray and the coffee grounds drawer.

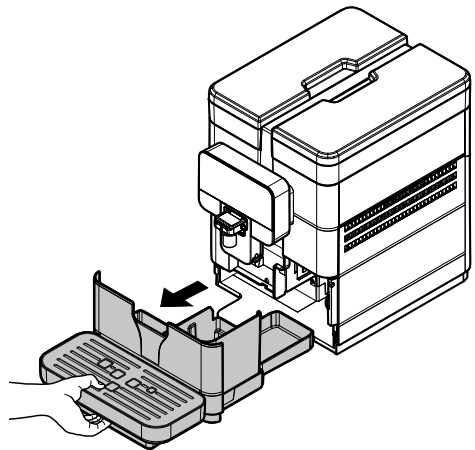

Remove the screw preventing accidental opening of the service compartment flap. (\* 120V USA version only).



Open the service compartment door.

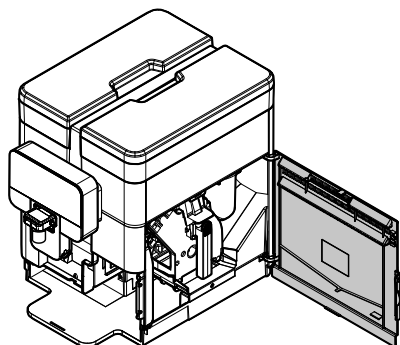

The reference marks indicate the amount of ground coffee which has been set.

You can set different amounts with the following references:

3 - Minimum coffee amount (about 6 grams)

4 - Maximum coffee amount (about 10 grams)

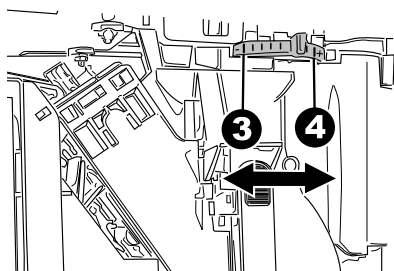

## 7.8 Adjusting the Coffee Dispensing Spout

Most of the cups and mugs available on the market can be used with this coffee machine.

The height of the dispensing spout can be adjusted to better fit the dimensions of the cups that you wish to use.

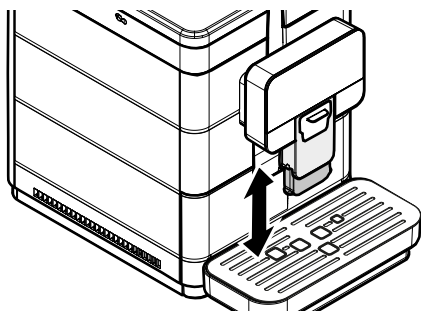

Manually move the dispensing spout up or down to adjust its height.

The recommended positions are:

- When using small cups.

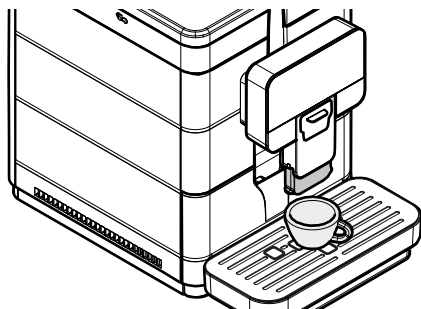

- When using mugs.

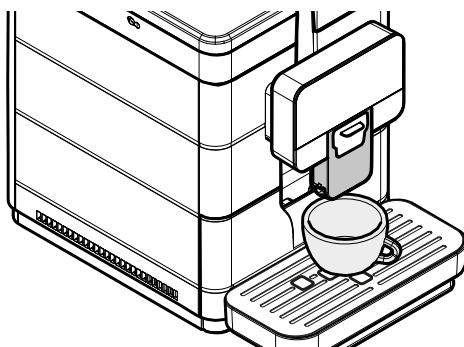

Two cups can be placed under the dispensing spout to brew two cups of coffee at the same time.

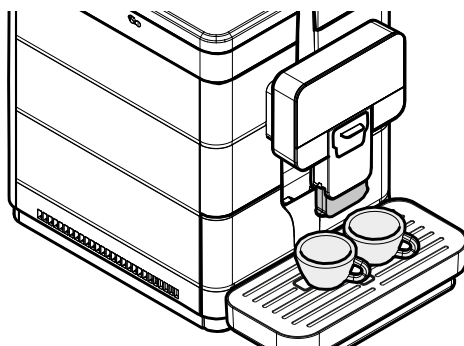

Push the dispensing spout towards the machine interior to its limit stop, to allow the use of tall glasses or MUGS. In this case, you can just brew one product at a time.

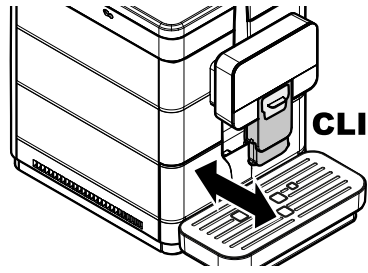
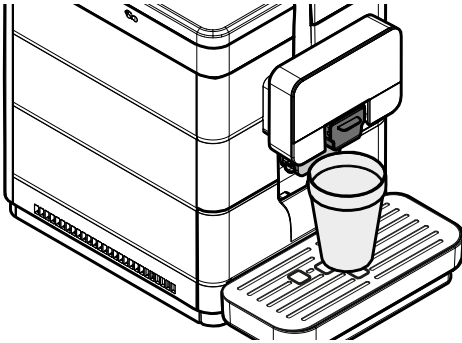
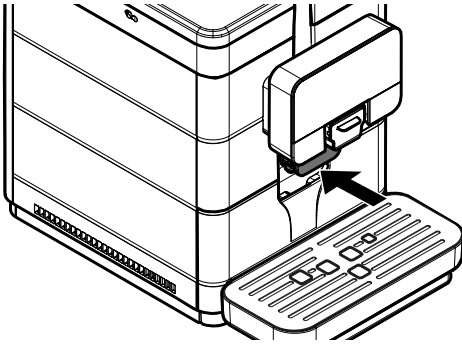

Otherwise, some product might leak out of the dispensing spout.

## 7.9 Turning on/off the machine

The machine can be turned on/off by pressing the button located to the rear of the machine.

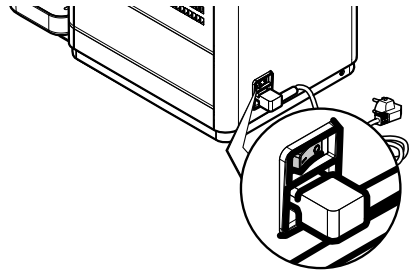

 Before brewing any product and/or when bringing the dispensing spout back to its normal position, ensure that it is correctly positioned. This can be evidenced by the **CLICK** indicating correct positioning.

## 7.10 Setting the Language (Upon First Use)

At first start-up, the desired display language of the messages must be selected and stored.



Select the language by pressing the "DOWN" button or the "UP" button. Press the "OK" button to save the language. The machine starts the system warm-up.

 Upon first use, once warm-up has been completed, the machine primes the circuit and performs a rinse cycle of the internal circuits. During this process, a small amount of water is dispensed. Wait for this cycle to be completed.

 If the machine fails its first start-up (brewing) make 2 further attempts. At the end of these 3 attempts, if the problem is not solved, let the machine rest for 30 minutes and then try again with 3 brewings. If the problem persists, please contact Customer Service.

## 7.11 First Use - Use after a Long Period of Inactivity

Refill the machine (follow the instructions above).

Connect the plug of the appliance to the mains (see section "Connection to the Electric Network").

For a perfect Espresso: rinse the coffee circuit if using the machine for the first time or after a long period of inactivity.

These simple operations will allow you to always brew excellent coffee.

They have to be performed:

- at first start-up;
- when the machine remains inactive for a long time (more than 2 weeks).

### 7.11.1 After a Period of Inactivity

Empty the water tank, wash and rinse it and fill it with fresh water (see section "Filling the Water Tank"). Place a large container under the coffee dispensing spout.

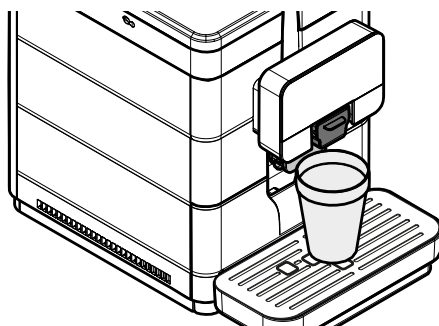

Press the "Coffee" button to start brewing. The machine starts brewing coffee from the dispensing spout. Wait until brewing has been completed and empty the container. Repeat the brewing process 3 times.

Place a container under the hot water dispensing spout.

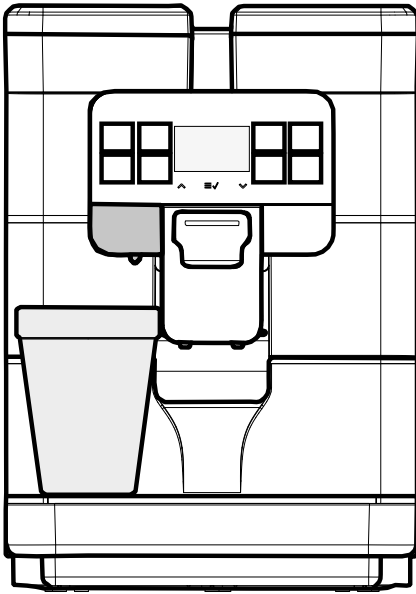

Press the "Hot Water" button to start dispensing HOT WATER.

When the hot water dispensing procedure has been completed, empty the container.

The machine is now ready for use.

## 7.12 Washing the Parts coming into Contact with Food

Rinse all the parts coming into contact with food.

- Thoroughly wash your hands.
- Prepare a chlorine-based, antibacterial disinfecting solution (the products can be purchased at the chemist's) following the concentrations indicated on the product.
- Remove all the covers and all the containers from the appliance.
- Immerse all these parts in the previously prepared solution.

## 7.13 Using the Appliance

 Before using the machine, read this manual carefully and make sure users are familiar with the machine.

 After the machine has not been used for a certain time, it is recommended to read section "First Use - Use after a Long Period of Inactivity" again, before using the module again.

The beverage selection modes are indicated in chapter "Operation and Use".

## 8 PROGRAMMING MENU

 This chapter contains instructions on how to set and change the programming parameters of the appliance.

 Therefore it is necessary to carefully read it and to understand the exact sequence of operations before performing them.

 All the operations described in this chapter must be performed exclusively by the service provider or a specialised technician, who shall organise all the operating steps and use only suitable means to ensure strict compliance with the safety regulations in force.

The specialised technician or the service provider can change some of the machine operating parameters to suit the needs of the users.

### 8.1 Button Description in Programming Mode

Use the buttons described below to scroll the appliance menus.

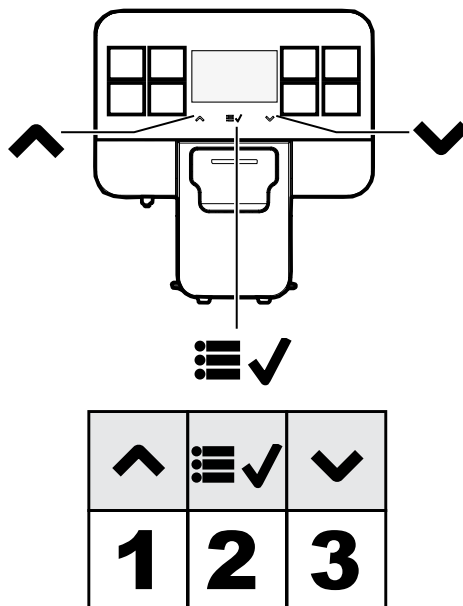

#### Button 1: Up

This button allows the parameters to be changed when they are displayed. (+) increases the value

#### Button 2: OK

It allows to confirm the parameter/value after changing it.

#### Button 3: Down

This button allows the parameters to be changed when they are displayed. (-) decreases the value

## 8.2 User Programming

The structure of the user menu is indicated in section "Structure of the User Menu".

Section "Description of Messages in the User Menu" describes all options in the user menu.

### 8.2.1 Access to the User Menu

When the machine is "ready for use", access the main menu by pressing the "OK" button.

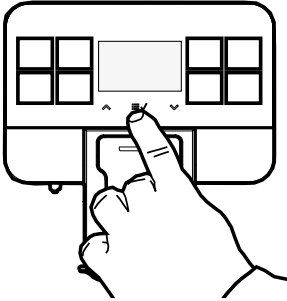

The following screen is displayed:



Select the "USER MENU" option and press the "OK" button.

**⚠** The menus can be accessed freely. However, they can be protected via PASSWORD.

**⚠** The PASSWORD will not be requested if set on the default value (0000). It should be changed upon first use to prevent unauthorised access. After this change, the password must be entered each time the display shows:

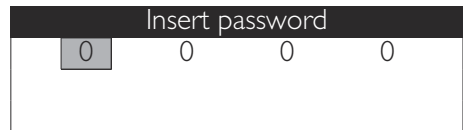

**ⓘ** In case you do not enter the password within 10 seconds the machine goes back to the previous screen.

Refer to section "Password Setting" to set the PASSWORD; this section describes how to set it.

 If you forget the PASSWORD, you can recreate it by entering a PUK code. You have to request the PUK code to the Saeco (Evoca group) service centre, who will guide you through the procedure.

## 8.2.2 Structure of the User Menu

The main options of the user menu are:

MENU ITEM
BREW GROUP CLEAN
CAPP. QUICK
CLEAN
Standard
Exit

## 8.2.3 Description of Messages in the User Menu

MENU ITEM	Description
BREW GROUP CLEAN	This function allows the user to wash the brew group using hot water
CAPP. QUICK	This function allows the user to perform cleaning using the Cappuccinatore hot water
CLEAN	This function allows you to clean the Cappuccinatore using hot water passing through the frothing device system after each dispensing of milk / mixed products.
Standard	This function allows you to thoroughly clean the Cappuccinatore and the milk suction tube. For this function the suction hose has to be immersed in clean water and specific detergent suitable for the removal of milk residues.
Exit	This option allows the user to go back to the menu top level
Exit	This function takes you back to the main menu

### 8.3 Technical Programming

The structure of the programming menu is indicated in section "Structure of the Programming Menu".

The section "Description of Messages in the Programming Menu" describes all the items in the programming menu.

#### 8.3.1 Access to the Technical Menu

When the machine is "ready for use", access the main menu by pressing the "OK" button.

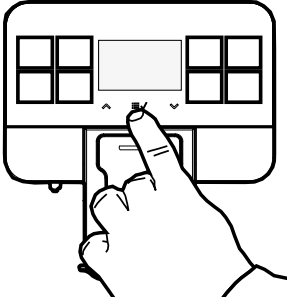



The following screen is displayed:



- Scroll the main menu until you reach the "Tech Menu" option.
- Press the "OK" button.

 The above mentioned procedure can only be used to access the programming menu when the machine has reached operating temperature.

 The menus can be accessed freely. However, they can be protected via PASSWORD.

 After this change, the password must be entered each time the display shows:

 The PASSWORD will not be requested if set on the default value (0000). It should be changed upon first use to prevent unauthorised access.

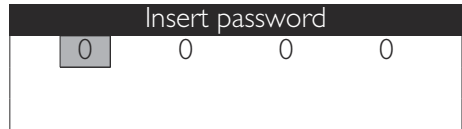

 In case you do not enter the password within 10 seconds the machine goes back to the previous screen.

Refer to section "Password Setting" to set the PASSWORD; this section describes how to set it.



 If you forget the PASSWORD, you can recreate it by entering a PUK code. You have to request the PUK code to the Saeco (Evoca group) service centre, who will guide you through the procedure.

### 8.3.2 Structure of the Technical Menu

This menu allows you to manage certain machine operation parameters.

The main items of the programming menu are:

MENU ITEM
Settings
Credits Menu
ENABLE CREDITS
Off
On
Add Credits
Reset Credits
yes
no
SHOW CREDITS
Off
On
Exit
BEVERAGE SETTINGS
Espresso
Coffee
HOT WATER
Cappuccino
Latte Macchiato
milk
AMERICAN COFFEE
BEVERAGE LENGTH
WATER QUANTITY
Exit
Exit
Machine Menu
General Menu
Tone
Off
On
Ecomode
Off

MENU ITEM
On
Stand-by Settings
15 minutes
30 minutes
60 minutes
180 minutes
Off
ALARMS
Coffee grounds drawer full alarm
Off
On
Descaling
Off
On
QUICK CLEAN
STANDARD CLEAN
Exit
PRE-GRINDING
Off
On
Pre-brewing
Off
Low
High
Temperature
Range from -5 to +5
USER PW
TECH. PW
Exit
Display Menu
Language
Contrast
Display Logo
Standard
Bean
Custom
Exit
Water Menu
Hardness
FILTER (0/8)
Exit
Descaling
FACTORY SETUP
READ CONFIG
WRITE
CONFIG
Statistics
Exit
FW UPDATE
BLUETOOTH
MACHINE SN
ACTIVATION
yes
no
KEYBOARD LOCK
On
Off
Exit

MENU ITEM
Exit
Exit
Statistics
products
TOTAL
Espresso
Espresso x2
Coffee
Coffee x2
Manual Brewing
AMERICAN COFFEE
HOT WATER
Cappuccino
Latte Macchiato
milk
TOTAL COFFEE BEVS
Exit
RESETTABLE
Espresso
Espresso x2
Coffee
Coffee x2
Manual Brewing
AMERICAN COFFEE
HOT WATER
Cappuccino
Latte Macchiato
milk
COUNTERS RESET
Exit
Exit
Errors
LOG
Reset errors
Exit
Water
Descaling
SINCE LAST
SINCE SECOND LAST
SINCE THIRD LAST
NUMBER OF EXECUTIONS
Exit
BREW GROUP CLEAN
NUMBER OF EXECUTIONS
SINCE LAST
Exit
CAPP. QUICK
STANDARD CLEAN
QUICK CLEAN
Exit
SINCE PRODUCTION
Exit
Exit
Exit

### 8.3.3 Description of Messages in the Technical Menu

MENU ITEM	Description
Settings	This menu allows you to access all machine configuration parameters
Credits Menu	This menu allows you to activate the use of virtual credits, load them onto the machine, reset them and enable the display of the "Ready for use" screen
ENABLE CREDITS	This function, if enabled, allows coffee brewing only if virtual credits have been loaded onto the machine. However, "hot water" can always be dispensed. The currently active setting is inside a dotted rectangular box.
Off	This setting disables the virtual credits checking system
On	This setting enables the virtual credits checking system
Add Credits	This function allows you to load virtual credits onto the machine
Reset Credits	This function allows you to reset all virtual credits on the machine
yes	
no	
SHOW CREDITS	This function, if enabled, displays the number of available credits in the left bottom corner of the "Ready for use" main screen. The currently active setting is inside a dotted rectangular box. NOTE: If the "ENABLE CREDITS" setting is on "OFF", the menu will not display the "SHOW CREDITS" option and will automatically set it to "OFF"
Off	To disable credit display. NOTE: If the virtual credits are less than 30, the machine will in any case show the residual value on the "Ready for use" screen
On	To enable credit display
Exit	This option allows the user to go back to the menu top level
BEVERAGE SETTINGS	This menu allows you to access the products' dose adjustment function.
Espresso	An Espresso will be brewed once the length of the beverage has been saved
Coffee	A Coffee will be brewed once the length of the beverage has been saved
HOT WATER	Hot water will be dispensed once the length of the beverage has been saved
Cappuccino	A Cappuccino will be brewed once the length of the milk part and coffee part has been saved
Latte Macchiato	A Latte Macchiato will be brewed once the length of the milk part and coffee part has been saved
milk	A Frothed Milk will be brewed once the length of the beverage has been saved
AMERICAN COFFEE	You access the American coffee configuration submenu
BEVERAGE LENGTH	It allows you to set the total beverage length (values from 325 to 735)
WATER QUANTITY	It allows you to set the water percentage to be dispensed according to the total dose. The currently active setting is inside a dotted rectangular box (LOW 30% / MED 50% / HIGH 70%)
Exit	This option allows the user to go back to the menu top level
Exit	This option allows the user to go back to the menu top level
Machine Menu	This menu manages general machine operation and maintenance parameters.
General Menu	To change the machine operating settings.
Tone	This function allows you to activate/deactivate the sound when you press a button on the keypad. The currently active setting is inside a dotted rectangular box.
Off	To deactivate the acoustic alarms.

MENU ITEM	Description
On	To activate the acoustic alarms.
Ecomode	This function controls the temperature management in the coffee boiler when the machine is in the "ready for use" mode. The function is set by default to «OFF». The currently active setting is inside a dotted rectangular box.
Off	This way, the coffee boiler is constantly kept at the right dispensing temperature. In this mode, the power consumption is higher because the machine is always ready for use.
On	This way, when in off position, the coffee boiler is kept at a temperature lower than the one required when dispensing a beverage. This way, the machine saves energy but needs more time to start dispensing beverages. The appliance is factory preset so that this setting is not enabled by default.
Stand-by Settings	To set the time interval for the machine to go into stand-by mode after the last brewing. The default time value is «after 30 minutes». The currently active setting is inside a dotted rectangular box.
15 minutes	Once the set time has elapsed, the machine goes into stand-by mode.
30 minutes	Press any button to turn the machine back on.
60 minutes	After performing the function diagnostics and the warm-up phase, the machine is again ready for use.
180 minutes	
Off	When this parameter is set to "OFF", the machine stays active.
ALARMS	It allows you to activate and deactivate some alarms.
Coffee grounds drawer full alarm	This function allows you to enable/disable the dregs alarms, i.e. the warning on the drawer with the already brewed coffee pods being full and its need to be emptied. The currently active setting is inside a dotted rectangular box.
Off	alarm disabled
On	alarm enabled
Descaling	This function enables/disables the warning (no blocking) on the need to descale the machine hydraulic circuit. This alert is displayed by a special icon on the "Ready for use" screen (see page 57). The currently active setting is inside a dotted rectangular box.
Off	With this setting, the warning message is disabled.
On	With this setting, the warning message is enabled; the message will be displayed whenever the machine requires a descaling cycle.
QUICK CLEAN	This function allows you to enable/disable the "Quick Clean" alarm, i.e. the warning for the Cappuccinatore quick clean cycle.
STANDARD CLEAN	This function allows you to enable/disable the "Standard Clean" alarm, i.e. the warning for the Cappuccinatore standard clean cycle.
Exit	This option allows the user to go back to the menu top level
PRE-GRINDING	This function enables/disables the pre-grinding prior the next coffee dose. This way, upon selecting the beverage, the user will already have the coffee powder ready for brewing and will save the grinding time. The currently active setting is inside a dotted rectangular box.
Off	With this setting, the pre-grinding function is disabled.
On	With this setting, the pre-grinding function is enabled;
Pre-brewing	This function adjusts the break time between pod pre-brewing and its actual dispensing.  The currently active setting is inside a dotted rectangular box.
Off	It disables pre-brewing
Low	It activates a short break between pre-brewing and dispensing (2 sec)
High	It activates a long break between pre-brewing and dispensing (4 sec)

MENU ITEM	Description
Temperature	This function allows you to adjust any increase/decrease in the coffee temperature inside the cups
Range from -5 to +5	It allows to lower or increase the temperature of the product on a range between -5 and +5.
USER PW	This function allows you to set or disable the password to access the User menu. NOTE: Enter the value '0000' as password to disable the password. If you forget the PASSWORD, you must start a reset procedure. Please contact Saeco (Evoca group) customer service.
TECH. PW	This function allows you to set or disable the password to access the Tech. menu. NOTE: Enter the value '0000' as password to disable the password. If you forget the PASSWORD, you must start a reset procedure. Please contact Saeco (Evoca group) customer service. Warning: The technical menu password also allows you to access the user menu
Exit	This option allows the user to go back to the menu top level
Display Menu	This menu allows you to set the language for the texts displayed on the screens and the display contrast ratio.
Language	This setting allows you to select one of the following 17 user interface languages: - ITALIAN - ENGLISH - GERMAN - FRENCH - SPANISH - PORTUGUESE - POLISH - RUSSIAN - SLOVENIAN - DUTCH - SWEDISH - HUNGARIAN - CZECH - SLOVENSKÝ - ROMANIAN - GREEK - BULGARIAN  The language currently in use is inside a dotted rectangular box.
Contrast	To set the correct display contrast according to room illumination.
Display Logo	This function allows you to change the image (logo) displayed on the "ready for use" screen and during machine start-up.  The currently active setting is inside a dotted rectangular box.
Standard	The standard logo is displayed, i.e. "ROYAL".
Bean	A coffee bean is display as logo.
Custom	This function allows you to set a customised logo by means of the Windows app provided to our customers.
Exit	This option allows the user to go back to the menu top level
Water Menu	This menu allows you to specify the water hardness used on the machine and control filter activation.
Hardness	To change the machine water hardness setting. With the "Hardness" function you can adjust your machine to the level of hardness of the water you use, so that the machine will request descaling at the right time. Measure water hardness as shown in section "Measuring and Adjusting Water Hardness".

MENU ITEM	Description
FILTER (0/8)	It allows you to check the water filter activation status and, possibly, to activate a new one.
Exit	This option allows the user to go back to the menu top level
Descaling	This function starts the descaling cycle as described in the relevant section.
FACTORY SETUP	This function allows you to return all machine configurations and products' doses to the factory-set values.  NOTE: the use of this function does not alter the following: - Credits - Password - Filter status - Counters and statistics on use
READ CONFIG	This function allows you to overwrite the current machine configuration (settings and doses), by loading another one via the USB key.  NOTE: The configuration file on the key must have been previously generated by a Royal OTC and should have the .MEM extension.
WRITE	In this menu you can save the current machine configuration and the statistics on its use to the USB key.
CONFIG	This function allows you to generate and save a .MEM file with the current machine configuration (settings and doses) to the USB key.  NOTE: The generated .MEM files can be used to overwrite the Royal OTC machine configuration.
Statistics	This function allows you to save in .TXT format the machine use statistics to the USB key, i.e.: - Beverage counters - Errors list - Maintenance cycles performed
Exit	This option allows the user to go back to the menu top level
FW UPDATE	This functionality makes it possible to update the machine firmware to a more recent version (supplied by the Saeco (Evoca Group) after-sales service) through a USB key. By selecting this option by means of the OK button you can restart the machine. The machine is re-started only if the update file is on the USB key and is correct; otherwise, an error message is displayed, and you can exit the update procedure.
BLUETOOTH	This function makes it possible to operate the Bluetooth module and machine functionality associated with it
MACHINE SN	This functionality makes it possible to read the S/N of the machine
ACTIVATION	This functionality makes it possible to activate the Bluetooth module if the machine is furnished with it
yes	Permits the functionalities of the Bluetooth module to be activate and restarts the machine
no	Deactivates the Bluetooth module
KEYBOARD LOCK	This functionality makes it possible to block the drink keys of the keyboard only leaving the menu navigations keys enabled. This forces the user to use the APP to request drinks.
On	Blocks the interface keyboard of the machine. Only the navigation keys remain enabled
Off	Releases the interface keyboard of the machine.
Exit	This option allows the user to go back to the menu top level
Exit	This option allows the user to go back to the menu top level
Exit	This option allows the user to go back to the menu top level

MENU ITEM	Description
Statistics	This function allows the user to view: - Product Counters - Errors list - Descaling and Washing counters
products	This function allows the user to view the number of products dispensed by the machine, distinguished according to the beverage type
TOTAL	In this section, the user can view the total number of products dispensed since the machine was started up. These counters cannot be reset.
Espresso	Total no. of espressos dispensed.
Espresso x2	Total no. of espressos x2 dispensed.
Coffee	Total no. of coffees dispensed.
Coffee x2	Total no. of coffee x 2 dispensed.
Manual Brewing	Total no. of manual brewing dispensed.
AMERICAN COFFEE	Total no. of American coffees dispensed.
HOT WATER	Total no. of hot waters dispensed.
Cappuccino	Total no. of cappuccinos dispensed.
Latte Macchiato	Total no. of latte macchiato dispensed.
milk	Total no. of milks dispensed.
TOTAL COFFEE BEVS	Total no. of coffee products dispensed.
Exit	This option allows the user to go back to the menu top level
RESETTABLE	In this section, the user can view the total number of beverages dispensed since the last time these "partial" counters were reset
Espresso	No. of espresso coffee cups brewed from the last RESET.
Espresso x2	No. of espressos x2 dispensed since the last RESET.
Coffee	No. of coffees dispensed since the last RESET.
Coffee x2	No. of coffees x2 dispensed since the last RESET.
Manual Brewing	No. of manual brewing dispensed since the last RESET.
AMERICAN COFFEE	No. of American coffees dispensed since the last RESET.
HOT WATER	No. of hot waters dispensed since the last RESET.
Cappuccino	No. of cappuccinos dispensed since the last RESET.
Latte Macchiato	No. of latte macchiato cups brewed from the last RESET.
milk	No. of milks dispensed since the last RESET.
COUNTERS RESET	To reset all the "partial" dispensed beverage counters.
Exit	This option allows the user to go back to the menu top level
Exit	This option allows the user to go back to the menu top level
Errors	This function allows you to manage and view the machine errors: - LOG - Reset Errors
LOG	This function allows you to view the machine errors.
Reset errors	This function resets the error list
Exit	This option allows the user to go back to the menu top level
Water	In this section you can view information about how to use the machine, including maintenance operations, and water usage in general
Descaling	This section displays the statistics pertaining to the descaling cycles enabled on the machine
SINCE LAST	It indicates the number of turbine pulses processed since the last time the descaling washing phase was completed
SINCE SECOND LAST	It indicates the number of turbine pulses processed between the second last and the last time the descaling washing phase was completed
SINCE THIRD LAST	Indicates the number of turbine pulses processed between the third last and the second last time the descaling washing phase was completed
NUMBER OF EXECUTIONS	It indicates the total number of descaling cycles performed by the machine.  The number of executions indicates how many descaling cycles were completed. The descaling cycle is complete when at least the first phase has finished, i.e. washing with descaling product.

MENU ITEM	Description
Exit	This option allows the user to go back to the menu top level
BREW GROUP CLEAN	This function allows the user to view the counters relating to the brew group washing cycles performed.
NUMBER OF EXECUTIONS SINCE LAST	Indicates the number of brew group washing cycles performed
Exit	This option allows the user to go back to the menu top level
CAPP. QUICK	This function allows you to view the counters for the performed Cappuccinatore cleaning cycles.
STANDARD CLEAN	It indicates the performed Cappuccinatore standard clean cycles' number
QUICK CLEAN	It indicates the performed Cappuccinatore quick clean cycles' number
Exit	This option allows the user to go back to the menu top level
SINCE PRODUCTION	This indicates the total number of turbine pulses processed by the machine since it was started up
Exit	This option allows the user to go back to the menu top level
Exit	This option allows the user to go back to the menu top level
Exit	This function takes you back to the main menu



### 8.3.4 Password setting

The PASSWORD must be set by the service provider in order to prevent access by unauthorised personnel who could change the machine settings and cause malfunctions.

You can set two passwords to access the two different machine menus.

To set the PASSWORD, proceed as follows:

Switch to machine programming mode as described in section "Access to the Technical Menu".

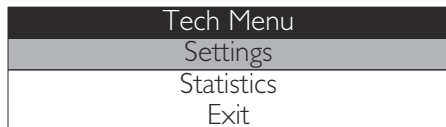

Select the "SETTINGS" option and press the "OK" button.



To select the "MACHINE MENU" option, press the "DOWN" button.

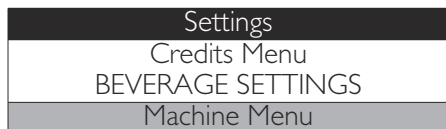

Press the "OK" button to enter. The following screen is displayed:



Press the "OK" button to access the "GENERAL MENU". The following screen is displayed:

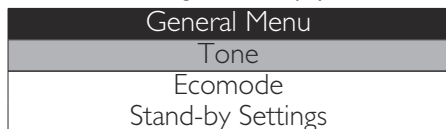

Scroll the menu using the "Down" button and select the "USER PW" option to set the user password or the "TECH. PW" option to set the technician option.



Press the "OK" button to enter. The following screen is displayed:



To enter the password:

Press the "Up" button or the "Down" button to set the desired number. Press the "OK" button to move to the next number.

Repeat the steps until the set password has been entered. Once the last number is entered, you return to the previous menu screen.

In case you want to change an already set password, follow the same procedure.

## 9 OPERATION AND USE

 The use by children older than 8 years or by persons with reduced physical, mental or sensory abilities or with lack of experience and skills is allowed, provided that they are supervised or instructed on how to use the appliance correctly and that they understand the hazards involved.

 Children must not play with the appliance. Children must not carry out any cleaning and maintenance operations without being monitored.

 For hygienic reasons, after the machine has not been used for a long time, it is recommended to thoroughly rinse the circuit.

### 9.1 Warm-up and Rinsing

Upon start-up, the machine activates the warm-up phase. Wait until it is completed.

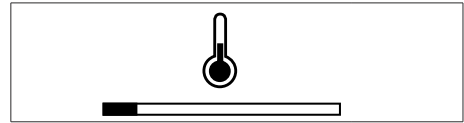

 The progress bar indicates that the machine is heating up the system.

Once warm-up has been completed, the machine performs a rinse cycle of the internal circuits.

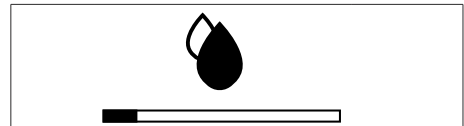

 The progress bar indicates that the machine is performing the rinse cycle of the system.

A small amount of water is dispensed. Wait until the cycle is completed.

-  The cycle can be stopped by pressing the lightened button.



When the logo is displayed, the machine is ready for use.

-  If the machine is used for the first time or after a long period of inactivity, contact the Service Provider to start it up.

## 9.2 Rinse/Self-Cleaning Cycle

This cycle allows to rinse the internal coffee circuit with fresh water. The cycle is carried out:

- At machine start-up (with cold boiler);
- During the Stand-by preparation phase (if at least one coffee-based product has been brewed);

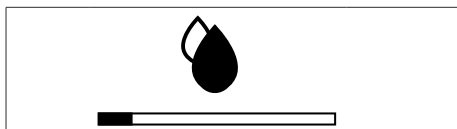

A small amount of water will be dispensed to rinse and heat all the machine parts. This icon is displayed.



Wait for this cycle to be completed automatically. The brewing can be stopped by pressing the illuminated push-button.

## 9.3 Eco-friendly: Stand-by

The machine is designed for energy saving. The machine will turn off automatically if it is not used for a set period of time after the last dispensing. This period of time is set by the service provider in the technical menu.

-  During the turn-off phase, the machine will perform a rinse cycle if a coffee product has been brewed.
-  Time can be programmed according to your needs (see instructions in chapter "Programming Menu").

Simply press a button on the control panel to restart the machine (if the power button is set to "I"). In this case the machine will go through the rinse cycle only if the boiler is cold.

## 9.4 Brewing Coffee

To brew coffee, press:

the "Espresso" button for an espresso;  
 the "Coffee" button to brew a coffee;  
 the "Manual Brewing" button to brew a variable length coffee selected by the user;  
 the "Americano" button to dispense an American coffee;

Then the brewing cycle starts:

Press the desired button once to brew 1 cup of coffee.

Press the desired button twice consecutively to brew 2 cups of coffee. This function is not available for the "American" coffee and "Manual Brewing" beverage.

 To brew 2 coffees, the machine automatically grinds and doses the correct amount of coffee.

 Brewing two cups of coffee requires two grinding cycles and two brewing cycles, which the machine carries out automatically.

Once the prebrewing cycle has been completed, coffee begins to come out of the dispensing spout. Coffee brewing stops automatically when the preset level is reached. you can in any case stop coffee dispensing by pressing the selected product button again when the rear LED light is not flashing but steady on.

 The machine is adjusted to brew a true espresso coffee. This feature may slightly lengthen the brewing time, allowing the intense coffee flavour to fully develop.

## 9.5 Cappuccinatore

This chapter explains how to use the milk Cappuccinatore to prepare a cappuccino, a Latte Macchiato or to froth milk.

 Before using the Cappuccinatore, clean it thoroughly as described in the "Cleaning and Maintenance" chapter.

 Use cold (~5°C / 41°F) milk with a protein content of at least 3% to ensure top-quality beverages. Whole milk, skimmed milk, soy milk or lactose-free milk may be used depending on individual taste.

 Do not use any liquids other than cleaning water or milk.

## 9.5.1 Installing the Cappuccinatore 9.6 Brewing Cappuccino

Insert the fitting into the Cappuccinatore.

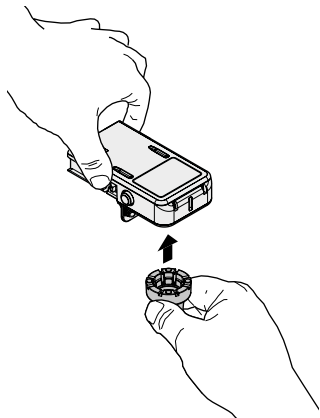

Insert the chrome-plated cover on the Cappuccinatore.

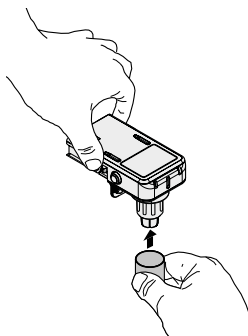

Insert the tube on the left-hand side of the fitting.

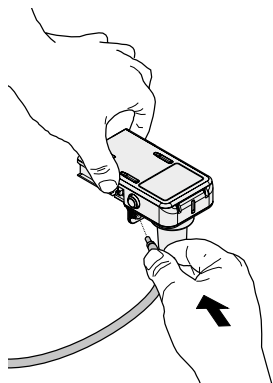

The machine can dispense cappuccino quickly and easily with the touch of a button.

- ⚠ Danger of burning! Dispensing may be preceded by small jets of hot water.
- 🧼 Clean the Cappuccinatore immediately after using it to froth milk (see section "Cappuccinatore Cleaning (After Each Use)").

- 🧼 Clean the suction hose externally with a damp cloth. This way, all parts will be perfectly clean and free of any milk residue.

Remove the cover from the front side.

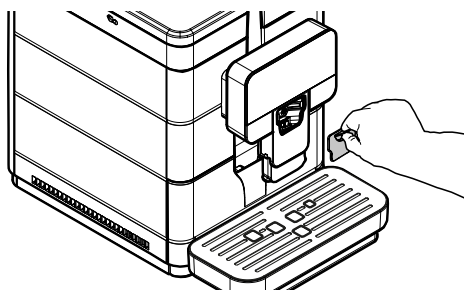

Insert the Cappuccinatore into its seat until it locks into place. Check that it cannot be pulled out.



To ensure better results when preparing a cappuccino, use cold milk.

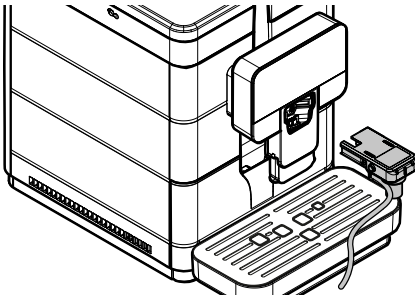

Place the cup under the dispensing spout.

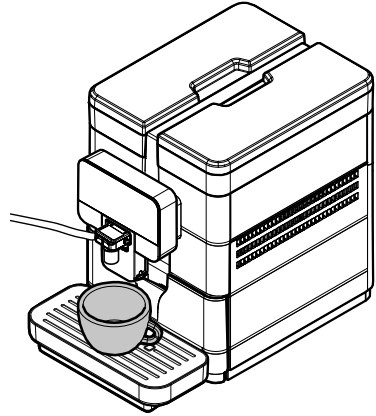
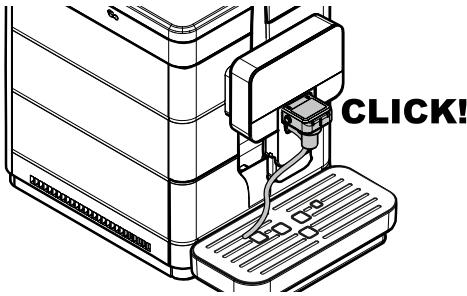

**⚠** Before using the Cappuccinatore, clean it as described in the "Cleaning the Cappuccinatore (After Each Use)" section.

Press the "Cappuccino" button. The machine needs time to preheat.

After preheating, the machine starts brewing cappuccino.

Insert the clean tube directly into the milk container.

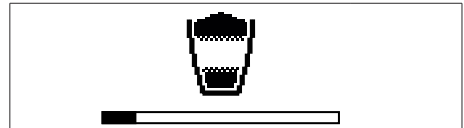

The machine dispenses frothed milk. Dispensing can be stopped by pressing the "Cappuccino" button.

Once milk has been brewed, the machine dispenses the coffee. Dispensing can be stopped by pressing the "Cappuccino" button.

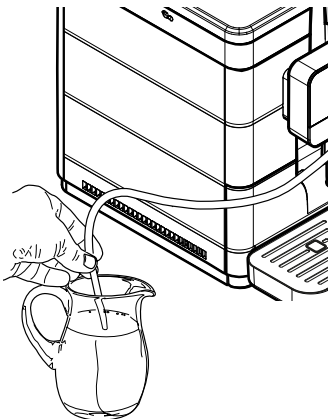

Enjoy your cappuccino as if straight from the coffee shop.

After using the Cappuccinatore, clean it as described in the "Cleaning the Cappuccinatore (After Each Use)" section.

Remove the container and clean it if necessary.

## 9.7 Brewing Latte Macchiato

The machine can dispense Latte Macchiato quickly and easily with the touch of a button.

 Danger of burning! Dispensing may be preceded by small jets of hot water.

 Clean the Cappuccinatore immediately after using it to froth milk (see section "Cappuccinatore Cleaning (After Each Use)").

 Clean the suction hose externally with a damp cloth. This way, all parts will be perfectly clean and free of any milk residue.

Remove the cover from the front side.

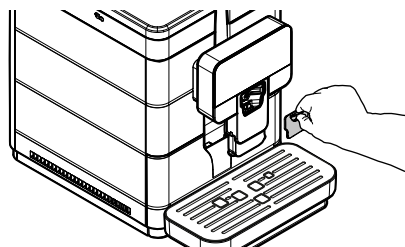

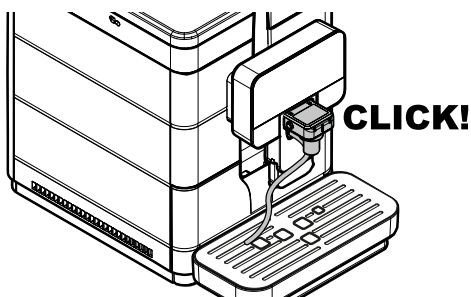
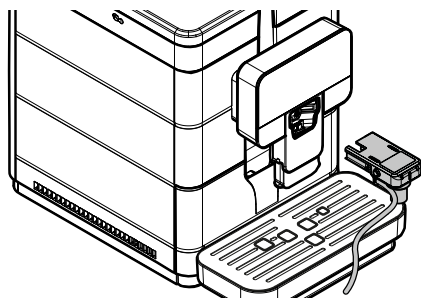

Insert the Cappuccinatore into its seat until it locks into place. Check that it cannot be pulled out.

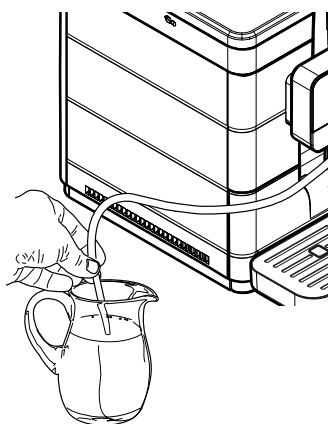

 Before using the Cappuccinatore, clean it as described in the "Cleaning the Cappuccinatore (After Each Use)" section.

Insert the clean tube directly into the milk container.



 To ensure better results when preparing a Latte Macchiato, use cold milk.

We recommend using tall glasses for this type of preparation, thus properly moving the coffee dispensing spout.

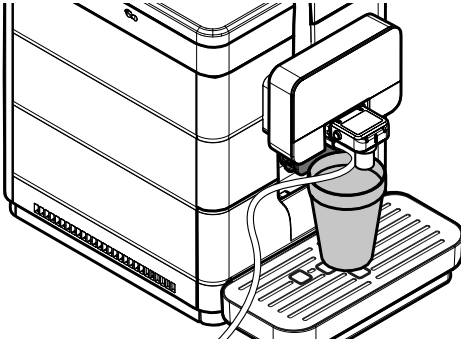

When the machine is ready, press the "Latte Macchiato" button to start dispensing the Latte Macchiato.

The machine prepares the Latte Macchiato automatically.

After using the Cappuccinatore, clean it as described in the "Cleaning the Cappuccinatore (After Each Use)" section.

Remove the container and clean it if necessary.

## 9.8 Milk dispensing

The machine can dispense Hot milk quickly and easily with the touch of a button.

 **Danger of burning!**  
Dispensing may be preceded by small jets of hot water.

 Clean the Cappuccinatore immediately after using it to froth milk (see section "Cappuccinatore Cleaning (After Each Use)").

 Clean the suction hose externally with a damp cloth. This way, all parts will be perfectly clean and free of any milk residue.

Remove the cover from the front side.

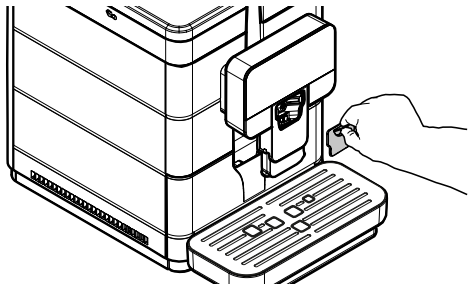

Insert the Cappuccinatore into its seat until it locks into place. Check that it cannot be pulled out.

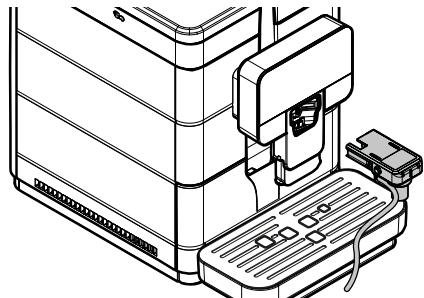



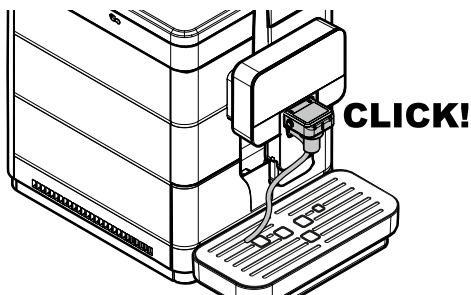

- ⚠ Before using the Cappuccinatore, clean it as described in the "Cleaning the Cappuccinatore (After Each Use)" section.

Insert the clean tube directly into the milk container.

We recommend using tall glasses for this type of preparation, thus properly moving the coffee dispensing spout.

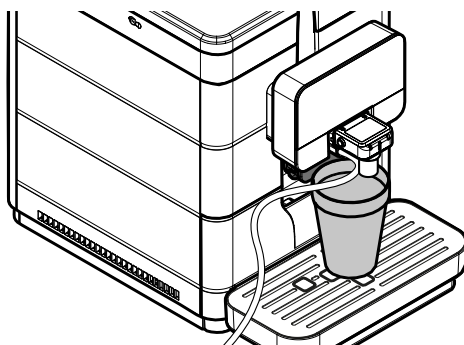

When the machine is ready, press the "Milk" button to start dispensing the hot milk.

The machine prepares the hot milk automatically.

After using the Cappuccinatore, clean it as described in the "Cleaning the Cappuccinatore (After Each Use)" section.

Remove the container and clean it if necessary.

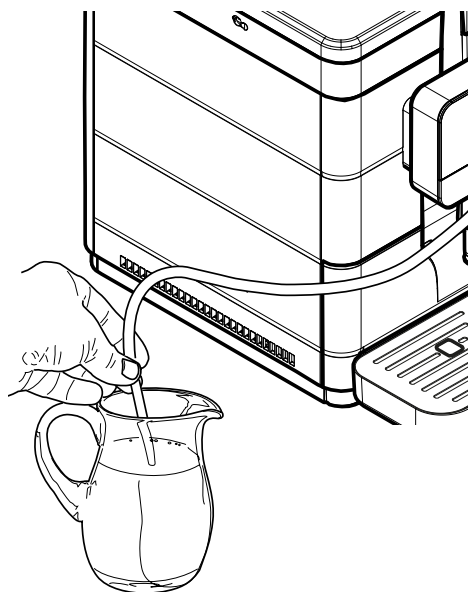

- 👉 To ensure better results when preparing milk, use cold milk.

## 9.9 Dispensing hot water

- ⚠ Danger of burning! Dispensing may be preceded by small jets of hot water and steam.

- ⚠ The hot water dispensing spout may reach high temperatures: never touch it with bare hands.

Ensure the machine is ready for use before dispensing hot water. Place a container under the hot water dispensing spout.

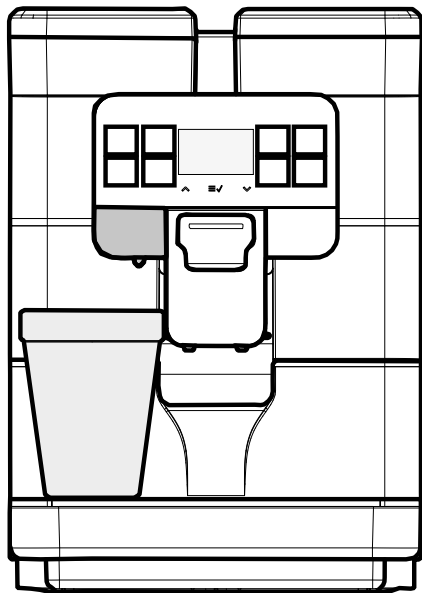

Press the "Hot Water" dispensing button. After a few moments hot water will be dispensed from the hot water dispensing spout.

The display will show:

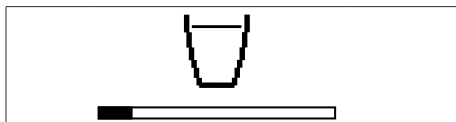

Product brewing stops automatically when the preset level is reached. The user can stop product brewing once the desired quantity is reached by pressing the "Hot Water" button again.

## 9.10 Adjusting Brewed Products

The machine allows you to adjust the product length according to your needs and to the type of cup used. Adjusting the product length can be performed by the service provider via keypad in visual mode. The product quantity is adjusted while being brewed. Only for the "American coffee" and given its particular dispensing cycle, you can adjust the dose and water percentage in parametric form.

Switch to machine programming mode as described in section "Access to the Technical Menu".

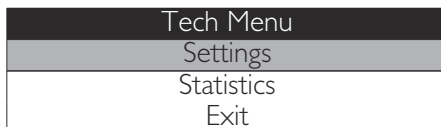

Select the "SETTINGS" option and press the "OK" button.

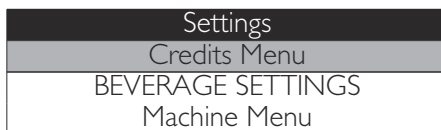

Press the "DOWN" button to select the "BEVERAGE SETTINGS" option.

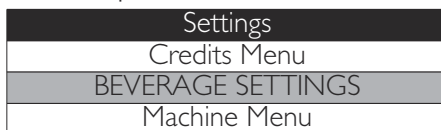

Press the "OK" button to enter.



Select the beverage that you wish to program and stop the brewing process when desired, as shown on the display. Set an espresso coffee as an example.

Place a cup under the dispensing spout.

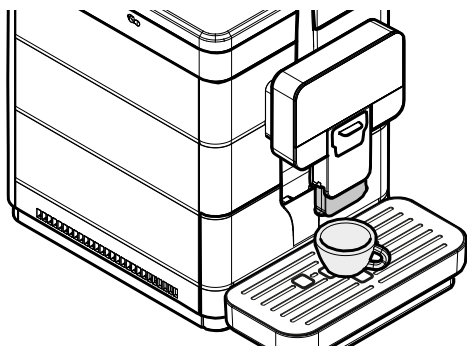

Select "Espresso". Press the "OK" button to enter. The machine starts brewing coffee. The following screen is displayed:

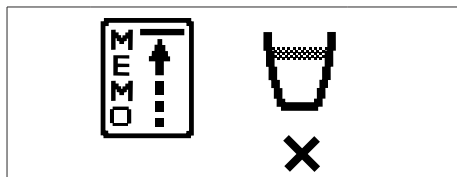

The "X" under the cup indicates that you can block the process (still in grinding phase). If you press the "OK" button at this time, storage is cancelled. Only when "V" is displayed under the cup you can save the dose adjustment.

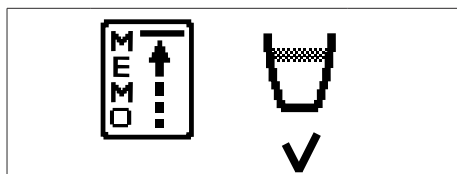

From now on you have to press the "OK" button when the desired amount of coffee in the cup has been reached. The "Espresso" button is now programmed. Each time it is pressed, the machine will brew the same amount that was just programmed.

This adjustment method is correct for all products apart from the "AMERICANO". To adjust the length of this product you have to use the configuration with parameters. This method allows you to set the beverage length and water amount values directly by means of the keypad. This system requires the user to carry out a subsequent check of the actual quantity of product brewed in the cup.

All the necessary operating steps are shown below.

Press the "DOWN" button to select an "AMERICANO".



Press the "OK" button to enter.



Press the "OK" button to select "BEVERAGE LENGTH".



Press the "DOWN" or "UP" button to select the desired value and then let the bar advance. The number on the side identifies the bar value (in pulses). Then press the "OK" button to confirm and exit.

Press the "DOWN" button to select the "WATER QUANTITY" menu.



Press the "OK" button to enter.

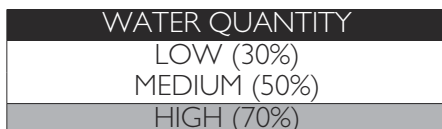

Press the "DOWN" button or the "UP" button to select the desired value. Then press the "OK" button to confirm and exit.

When this phase has been completed, the beverage is programmed. It is recommended to perform a visual check of the result.

### 9.11 Using the Machine with Credits

 This option can be enabled or disabled by the service provider.

The machine is designed to manage beverage brewing by means of a credit system. The number of coffee-based products brewed is limited to the number of credits granted by the service provider. When no credits remain, no more coffee-based products can be brewed.

The residual credits can be seen on the "Ready for use" screen, if the "SHOW CREDITS" option was enabled.

 Hot water dispensing is not subject to credit and can always be performed provided that there is water in the tank.

Each service provider decides independently how to manage the granting and recharging of credits to allow the machine to be used.

### 9.12 Emptying the coffee grounds drawer and drip tray

 This operation must be performed with the machine turned on and/or in stand-by mode.

The machine will indicate when the coffee grounds drawer has reached its maximum capacity. The first warning alerts the user that the coffee grounds drawer must be emptied, but the machine can still be used to brew coffee.

The display will show:



If the coffee grounds are not removed after 5 coffee brewing cycles, the machine will stop, and the display will show:

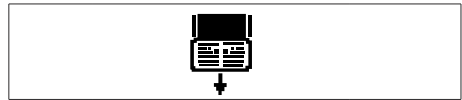

In this case, the machine does not allow beverages to be dispensed. In order to dispense beverages, the coffee grounds drawer must be emptied of used coffee. Extract the drip tray and the coffee grounds drawer.

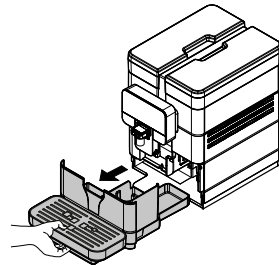

Raise the coffee grounds drawer.

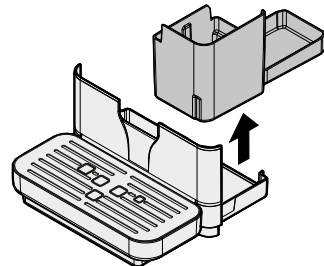

Empty the coffee grounds drawer and the drip tray.

- ☞ Liquids and coffee grounds must be disposed of separately, as appropriate.

Only when the display shows:

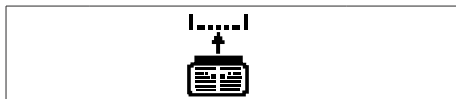

You can insert the coffee grounds drawer and the drip tray in the machine.

- ☞ If the drip tray is inserted without the coffee grounds drawer, the machine will not dispense products.

After inserting them, the display shows:



The machine is now ready to brew coffee.

## 9.13 BLUETOOTH

(\*if present on the machine)

The machine is set up to use a proprietary Bluetooth module (hereinafter BT). If present, it must be enabled through the Technical Menu, BLUETOOTH item. Refer to the "Description Technical Menu Messages" of the "Programming Menu" chapter to display the description of the commands available.



The BT makes it possible:

- To make selections remotely through the "Saeco Pro Up" app, also without registration. The app can be downloaded by framing the following QR code.



- Set the machine to operate credits through the "Saeco Pro Up" portal. The dedicated manual is available on the eCommerce EVOCA site. Following is the link to the eCommerce EVOCA site. <https://ecommerce.evocagroup.com/> The site can be accessed also by framing the following QR code.



- Perform the authentication procedure.
- Select the Saeco brand.
- Select "Search".
- Select "Documents".
- Select "Manuals kit" in the "Document type" box.
- Enter "New Royal" in the "Model Description" box.
- Press the "Search" key.
- Click on the following icon:





- Select the dedicated manual.
- Order and/or load the machine credits from the "Saeco Pro Up" app, if logged with registered and enabled user.
- Make the adjustment of the technical setting directly from "Saeco Pro Up" app if logged with registered and enabled user.

 In the event of maintenance with the machine turned on, before any operation disconnect the connection wiring of the Bluetooth kit.

## 10 CLEANING AND MAINTENANCE

 Before performing any maintenance and/or cleaning operation, unplug the power cord.

 The Manufacturer is not liable for damage or malfunctions caused by a wrong or lack of maintenance.

 Avoid using chlorine-based tablets so as to prevent oxidation phenomena inside the appliance.

### 10.1 General Notes for Correct Operation

 Non-removable components and the machine itself must be cleaned, when not differently specified, only by using cold or lukewarm water, with a non-abrasive sponge and a damp cloth.

 Never use direct jets of water onto the appliance and/or its components.

Periodic maintenance and cleaning will keep the machine in good working order for a longer time and ensure compliance with basic hygienic standards.

Follow the instructions and timing indicated in the "MAINTENANCE SCHEDULE" to ensure correct operation of the appliance.

## 10.2 Cleaning and Scheduled Maintenance

 All parts requiring cleaning are easily accessible, so no tools are needed.

 All parts must be washed with lukewarm water only and without using detergents or solvents that could change their shape or performance.

 All removable parts cannot be washed in the dishwasher.

 Do not clean the electric parts with wet cloths and/or with degreasing detergents. Remove any dust residues with a jet of dry compressed air or with an antistatic cloth.

### 10.2.1 Maintenance Schedule

Operation to be carried out	A	B	C	D	E
Drip tray	-	-	X	-	-
Emptying and cleaning the coffee grounds drawer	-	X	-	-	-
Cappuccinatore quick clean	X	X	-	-	-
Thorough Cleaning of the Cappuccinatore	-	X	-	-	-
Water tank cleaning	-	-	-	X	-
Brew group cleaning	-	-	-	X	-
Brew group lubrication	-	-	-	-	X
Coffee bean hopper cleaning	-	-	-	-	X
Descaling	-	X	-	-	-

- A** After each use
- B** When an alert is shown
- C** Daily
- D** Weekly
- E** Every month or 500 brewing cycles

 The machine and its parts should in any case be cleaned every week.

 The appliance and its parts should be cleaned and washed following a period of inactivity.

### 10.2.2 Cleaning the drip tray and coffee grounds drawer

The coffee grounds drawer is to be emptied and cleaned whenever indicated by the machine. However, it is recommended to empty it daily. To carry out this operation, see section "Emptying the coffee grounds drawer and drip tray".

In any case, whenever maintenance of the machine is carried out, it is suggested you remove and clean the coffee grounds drawer.

At this time, it is also advisable to clean the cup holder grills.



### 10.2.3 Cleaning the Water Tank

Remove the lid from the water tank.

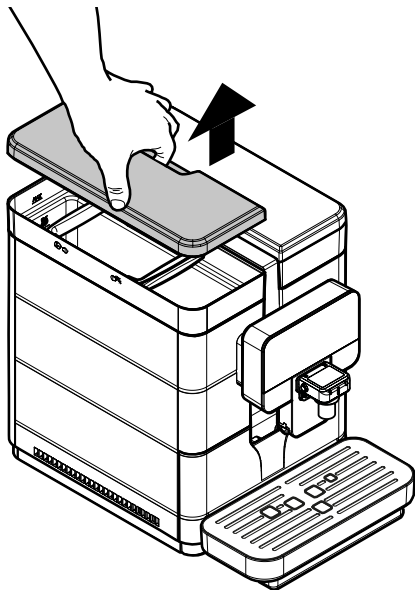

Remove the tank; lift it using the inside handles.

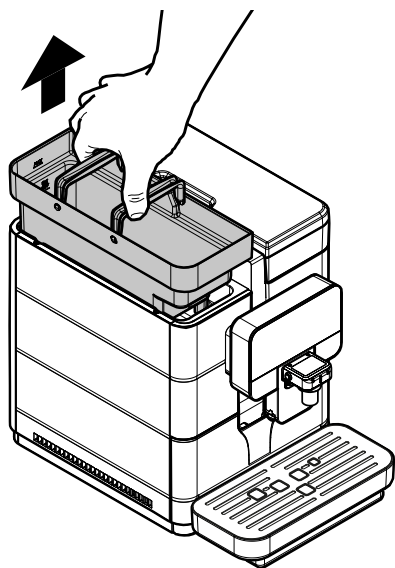

Use a non-abrasive detergent to wash it, rinse with fresh water and dry carefully.

### 10.2.4 Cappuccinatore quick clean (After each use)

**⚠** Failure to clean the Cappuccinatore after use with milk may cause proliferation of bacteria which may be harmful for the user.

**⚠** The milk circuit must be quickly rinsed after use to always ensure proper hygiene.

The Cappuccinatore must be washed and cleaned every time it is used. The lack of cleaning before and after each use can affect the correct operation of the machine.

**⚠** Danger of burning! Dispensing may be preceded by small jets of hot water.

After each milk dispensing, the display shows the following screen for a few seconds.

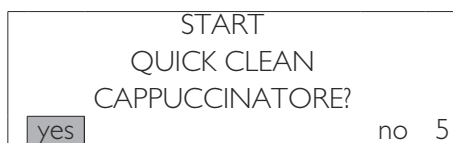

Proceed as follows to perform the rinse cycle: Select "YES" and press the "OK" button. The following screen is displayed:

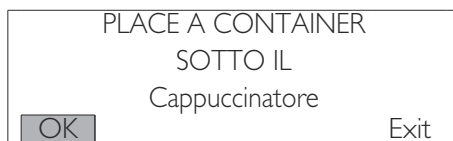

Place a container under the Cappuccinatore spout.

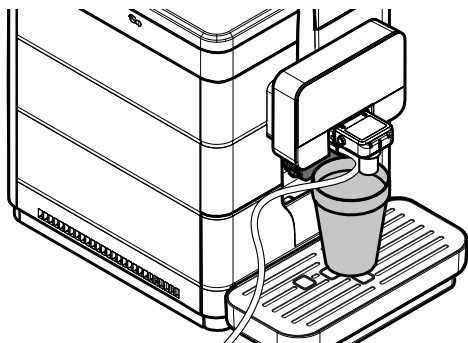

The Cappuccinatore quick cleaning cycle can be performed any time by following the procedure below: With the machine on, press the "OK" button.

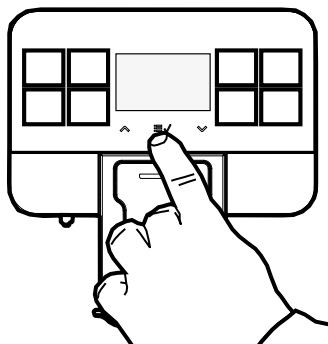

Select "OK" and press the "OK" button. The machine dispenses a quantity of water sufficient to rinse the milk circuit. The following screens are displayed:

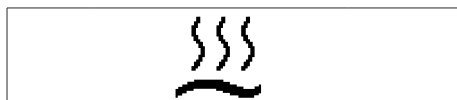

Remove the container.

In case you do not want to perform the rinse cycle, select "NONE" using the arrow key. Press the "OK" button. After a certain time, this rinse request screen automatically disappears and the machine goes back to the ready for use mode.

 Always remember to store milk in the fridge when not used.

This function allows the machine to preserve proper hygiene and operating conditions, but in no case should it be considered sufficient as the only way of cleaning the milk circuit.

The following screen is displayed:



Select the "USER MENU" option and press the "OK" button. The following screen is displayed:



Press the "Down" button to select "CAPP. CLEAN" and then press "OK" to confirm. The following screen is displayed:



Select the "QUICK" option and confirm with the "OK" button.



Select "YES" and press the "OK" button. The following screen is displayed:

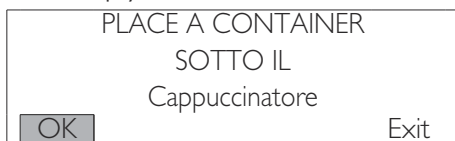

Place a container under the Cappuccinatore spout.

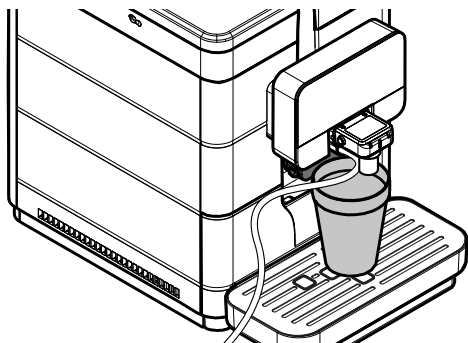

Select "OK" and press the "OK" button. The machine dispenses a quantity of water sufficient to rinse the milk circuit. The following screens are displayed:

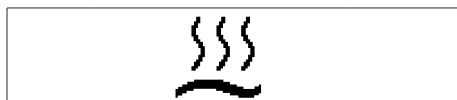

In this case, the washing cycle is performed with hot water only and the suction tube is not used. At the end of the cleaning cycle, it must be compulsorily washed under running water. Wait until the cycle stops automatically. The machine will go back to the ready for use state.

### 10.2.5 Thorough Cleaning of the Cappuccinatore

Clean all the Cappuccinatore parts thoroughly every month using the Saeco detergent. The Saeco detergent may be purchased at your local dealer or at authorised service centres.

The lack of cleaning before and after each use can affect the correct operation of the machine.

**⚠** Danger of burning!  
Dispensing may be preceded by small jets of hot water.

Ensure that the Cappuccinatore is correctly positioned.

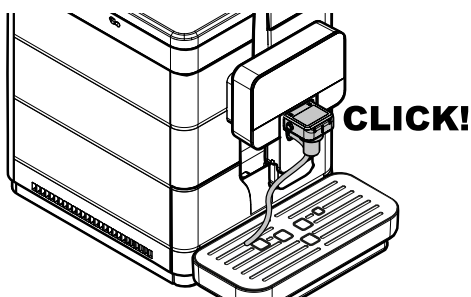
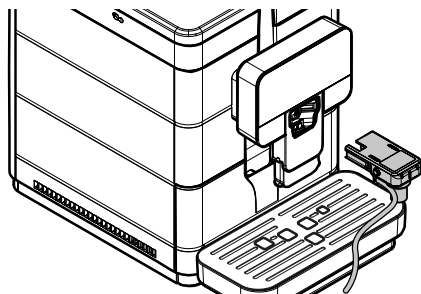

With the machine on, press the "OK" button.

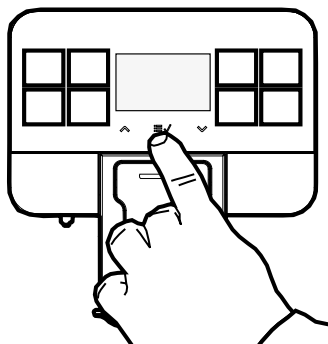

The following screen is displayed:

Menu
User menu
Tech Menu
Exit

Select the "USER MENU" option and press the "OK" button. The following screen is displayed:

User menu
BREW GROUP CLEAN
CAPP. QUICK
Exit

Press the "Down" button to select "CAPP. CLEAN" and then press "OK" to confirm. The following screen is displayed:

CAPP. QUICK
CLEAN
Standard
Exit

Select the "STANDARD" option and confirm with the "OK" button.

START
STANDARD CLEAN
CAPPUCCINATORE?
<input type="checkbox"/> yes <input type="checkbox"/> no 5

Select "YES" and press the "OK" button. The following screen is displayed:

FILL WATER TANK
Water
<input type="checkbox"/> OK <input type="checkbox"/> Exit

Fill the water tank and press the "OK" button to confirm.

POUR DETERGENT
IN A CONTAINER
WITH 1/2 L WATER
<input type="checkbox"/> OK <input type="checkbox"/> Exit

Pour a sachet of solution into a container with 1/2 (half) litre of fresh drinking water.

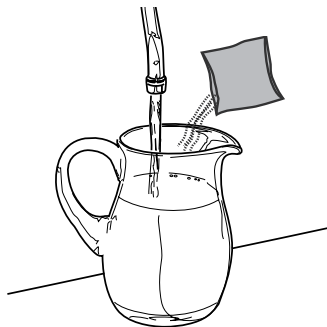

Wait for the bag content to dissolve completely and then press the "OK" button to confirm.

PUT TUBE IN
Cappuccinatore
IN THE CONTAINER
<input type="checkbox"/> OK <input type="checkbox"/> Exit

Insert the clean tube directly into the container. Press the "OK" button to confirm.

 Do not drink the solution dispensed during this procedure. The solution must be disposed of.

PLACE A CONTAINER
SOTTO IL
Cappuccinatore
<input type="checkbox"/> OK <input type="checkbox"/> Exit

 If this option is confirmed, the cycle must be completed. Press the "ESC" button to exit.

Place an empty container of at least 1 litre capacity under the dispensing spout and press the "OK" button to confirm. The machine performs a Cappuccinatore standard clean cycle.



The bar shows the washing progress. Wait until the cycle stops automatically. When the cycle has been completed, the display shows:



Rinse the water tank and fill it with fresh drinking water. Press the "OK" button to confirm.

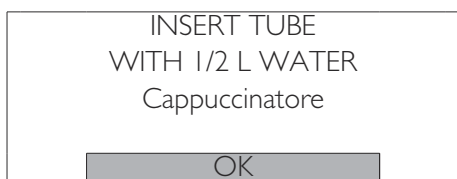

Wash the container used for the solution thoroughly and fill it with 1/2 (half) litre of fresh drinking water which will be used for rinsing. Empty the container placed under the dispensing spout. Insert the suction hose into the container used. Press the "OK" button to confirm.





Place an empty container under the dispensing spout and press the "OK" button to confirm.



The machine performs a Cappuccinatore rinse cycle. The bar shows the rinsing progress.

Wait until the cycle stops automatically. The machine will go back to the normal operating cycle.

 It is advisable to remove the Cappuccinatore from the machine when not being used, in order to keep it clean.

 Here is an explanation of how to disassemble and wash the Cappuccinatore with left-hand fitting. If the right-hand fitting is installed, you can carry out the same operations except that you will need to remove the suction tube and insert it on the opposite side to that shown here.

Remove the suction tube from the Cappuccinatore.

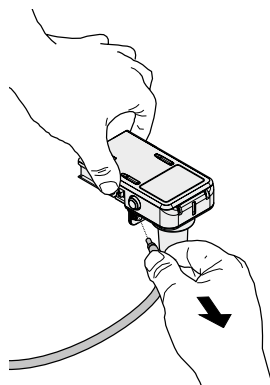

Remove the chrome-plated cover from the Cappuccinatore. Remove the valve from the Cappuccinatore.

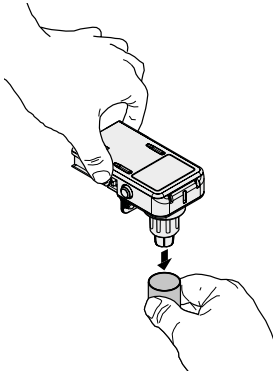

Remove the ring from the Cappuccinatore.

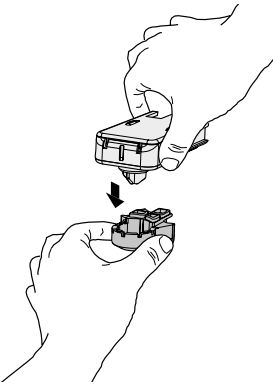

Turn and lift the Cappuccinatore cover and remove it from the Cappuccinatore body.

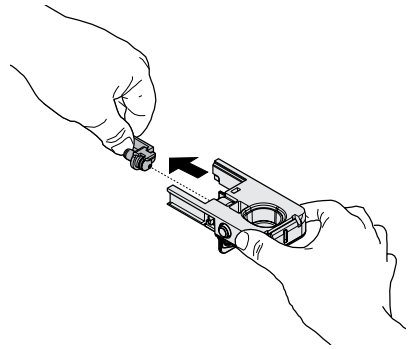
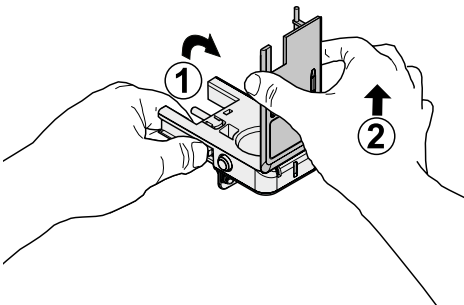

Wash the parts under running water. Make sure any milk deposits/residues are removed.

After washing, reassemble the parts following the same procedure used for disassembly, but in reverse order.

 After washing and reassembling the Cappuccinatore, it can be installed back in the machine.

### 10.2.6 Brew Group Cleaning

The brew group should be cleaned whenever the coffee bean hopper is filled, or at least once a week. Turn off the machine by switching the power button to the "O" position and remove the plug from the socket. Extract the drip tray and the coffee grounds drawer.

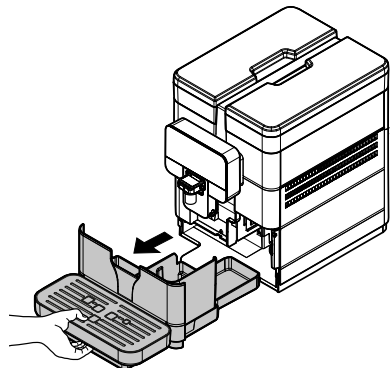

Remove the screw preventing accidental opening of the service compartment flap. (\* 120V USA version only).

Open the service door.

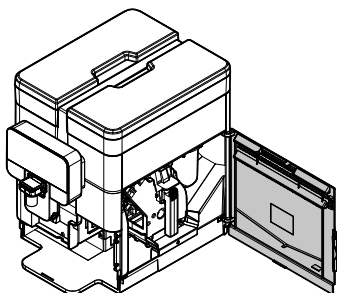

Remove the brew group by pulling it by the handle and pressing the «PRESS» button. The brew group must be washed with lukewarm water only. Do not use any detergent.

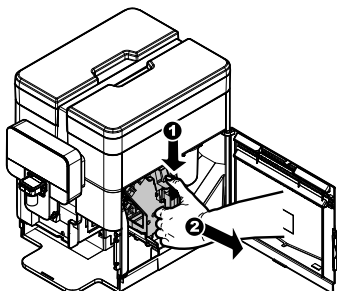

Wash the brew group with lukewarm water; carefully wash the upper filter. Before placing the brew group in its seat, ensure that there is no water left in the brewing chamber.

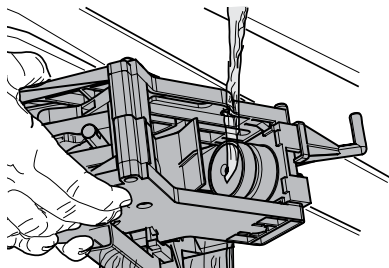

Make sure that the brew group is in the off position. The two reference marks must match.

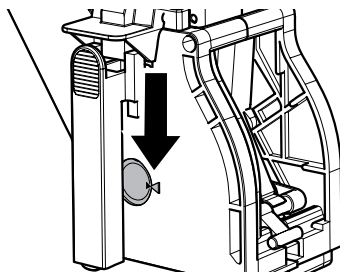

If they do not match, proceed as described below:

Ensure that the lever is in contact with the brew group base.

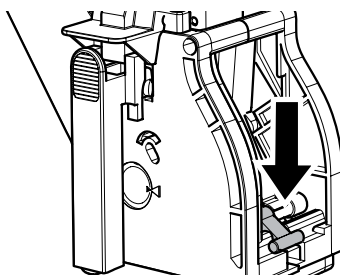

Make sure that the hook which locks the brew group is in the correct position. firmly press the "PRESS" button to check its position.

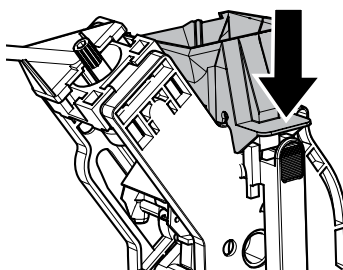

Insert the brew group into its seat again until it locks into place WITHOUT pressing the "PRESS" button.

Close the service door.

Re-insert the screw preventing accidental opening of the service compartment flap. (\* 120V USA version only).

 Ensure that the brew group is completely dry before putting it back into the machine.

## 10.2.7 Brew Group Cleaning with the "Coffee Oil Remover"

Besides weekly cleaning, we recommend performing a cleaning cycle with "Coffee Oil Remover" after approximately 500 cups of coffee or once a month. This operation completes the maintenance process for the brew group. The "Degreasing tablets" for cleaning the coffee unit and the maintenance products can be purchased from your local dealer or the authorised support centres.

**⚠** The "Coffee Oil Remover" system has no descaling properties. For descaling, use the Saeco descaling solution and follow the procedure described in the "Descaling" chapter.

The wash cycle cannot be interrupted. Do not leave the machine unattended during this operation.

**⚠** Do not drink the solution dispensed during this procedure. The solution must be disposed of.

Access the user menu as described in the "Access to the User Menu" section.



Press the "OK" button to access the brew group cleaning cycle.



Press the "OK" button to enter.



Press the "OK" button to start the brew group cleaning cycle.



Extract the drip tray and the coffee grounds drawer.

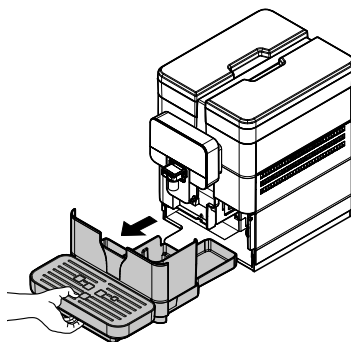

Remove the screw preventing accidental opening of the service compartment flap. (\* 120V USA version only).

Open the service door.

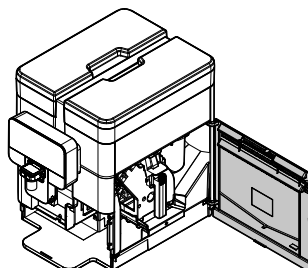

Remove the brew group by pulling it by the handle and pressing the «PRESS» button.

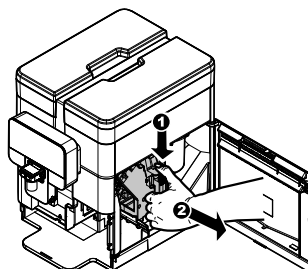



Press the "OK" button to confirm the removal of the brew group.



 If this option is confirmed, the cycle must be completed. Select "EXIT" to exit.

Place the cleaning tablet in the brew group and refit the group in the machine, making sure that all the components have been inserted and that the door is closed.

Re-insert the screw preventing accidental opening of the service compartment flap. (\* 120V USA version only).

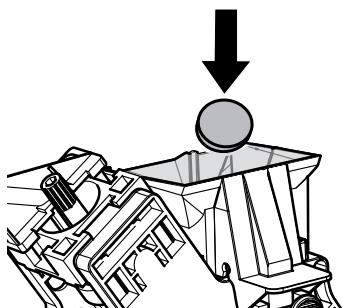

After placing the tablet in the brew group, press the "OK" button to confirm.

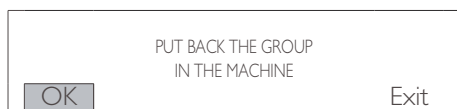

Put the brew group back into the machine and press the "OK" button to confirm.

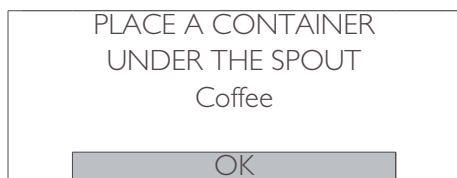



Place a container under the coffee dispensing spout and press the "OK" button to confirm.



The machine completes the cycle automatically.

 At the end of the cycle, after performing the rinse cycle, the machine goes back to its normal operating mode.

 It is recommended to remove the group and wash it under fresh running water.

 Ensure that the brew group is completely dry before putting it back into the machine.

### 10.2.8 Brew group lubrication

Lubricate the brew group after approximately 500 cups of coffee or once a month. The grease for lubricating the coffee unit and the relative accessories can be purchased from your local dealer or the authorised support centres.

 To see how many coffees have been dispensed, see the "PRODUCTS" menu in the "STATISTICS" menu of the tech. menu (see section "Description of messages in the programming menu").

Before lubricating the brew group, clean it under running water as described in the "Brew Group Cleaning" chapter.

Lubricate the brew group guides using Saeco grease only.

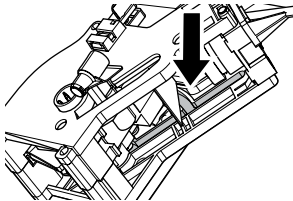

Apply the grease evenly on both side guides.

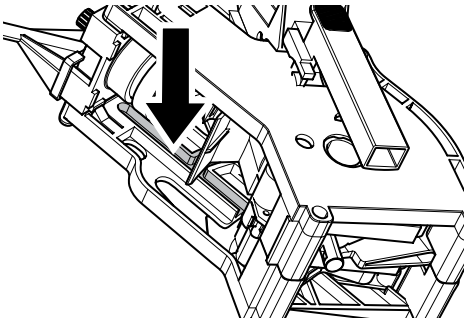

Lubricate the shaft too.

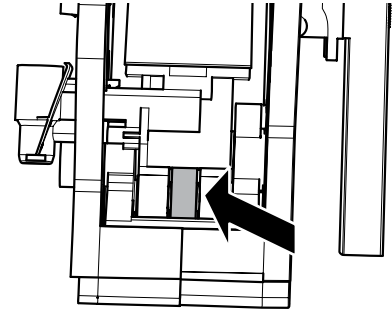
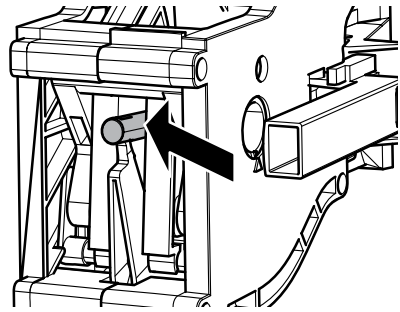

Insert the brew group into its seat again until it locks into place **WITHOUT** pressing the "PRESS" button.

Close the service door.

Re-insert the screw preventing accidental opening of the service compartment flap. (\* 120V USA version only).

Insert the coffee grounds drawer and the drip tray.

## 10.2.9 Descaling

Limescale is a natural part of the water used for machine operation. It needs to be removed regularly as it may clog the water and coffee circuit of your appliance. The machine indicates on the display when descaling is required.



Just follow the steps described below. This operation needs to be carried out before the appliance stops working properly, as in this case repair is not covered by warranty. The descaling and maintenance products can be purchased from your local dealer or the authorised support centres.

**⚠** Never drink the descaling solution.

**⚠** Never use vinegar as a descaling solution.

**⚠** Before inserting the descaler, remove the antiscaler filter, if present.

Turn on the machine by pressing the ON/OFF button. The following screen is displayed when rinsing and warm-up are complete:



Select "YES" and press the "OK" button. The following screen is displayed:

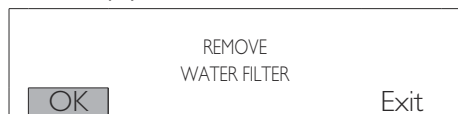

**👉** This screen will be visible only if the water filter has been activated.

Remove the tank from the machine and empty it. Remove the anti-scale filter. Select "OK" and press the "OK" button. The following screen is displayed:

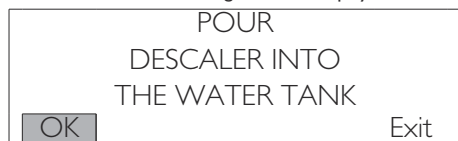

Pour 250 ml of descaling product into the water tank. Select "OK" and press the "OK" button. The following screen is displayed:

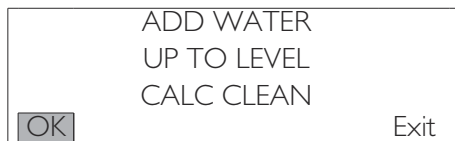

Put back the water tank. Add water into the water tank up to the "CALC CLEAN" level. Select "OK" and press the "OK" button. The following screen is displayed:



Remove and empty the drip tray.

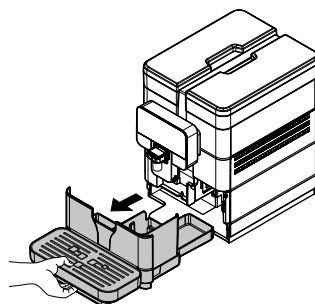

After emptying it put the drip tray back into place. Select "OK" and press the "OK" button. The following screen is displayed:



Check that the Cappuccinatore is correctly positioned. Select "OK" and press the "OK" button. The following screen is displayed:

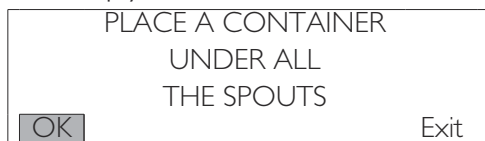

Place a large container under the dispensing spouts (hot water and coffee).

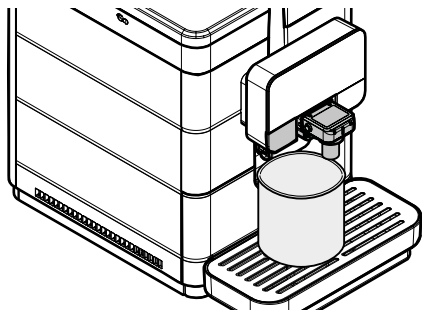

Select "OK" and press the "OK" button. The following screen is displayed:

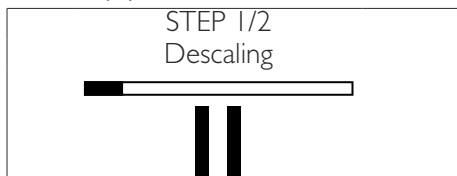

The first descaling phase starts. Press the "OK" button to pause the operation. Press the "OK" button again to resume the operation. When the solution in the tank is finished, the machine requests to empty and rinse the tank with fresh drinking water.



Rinse the water tank thoroughly and fill it with fresh drinking water up to the MAX level. Press the "OK" button. The following screen is displayed:



Remove and empty the drip tray. After emptying it put the drip tray back into place. Press the "OK" button. The following screen is displayed:



Check that the Cappuccinatore is correctly positioned. Press the "OK" button. The following screen is displayed:



Place a large container under the dispensing spouts (hot water and coffee). Press the "OK" button. The following screen is displayed:



Press the "OK" button to pause the operation. Press the "OK" button again to resume the operation. On completion, the following screens are displayed:

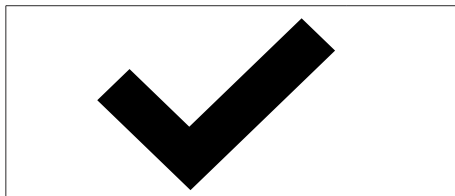

Re-insert the small white filter or water filter based on how you have chosen to proceed. Then, select "YES" or "NO" based on the choice made and press "OK". Fill the water tank again up to the MAX level with fresh drinking water.

After completing the descaling cycle, empty the containers used to collect the liquids during descaling. The descaling solution must be disposed of as provided on the container and/or the regulations in force in the country of use. Empty the drip tray and place it back.

If you wish to carry out a descaling cycle with the machine already on, you need to access programming as indicated in section "Accessing the tech. menu".

Tech Menu
Settings
Statistics
Exit

Select the "SETTINGS" option and press the "OK" button.

Settings
Credits Menu
BEVERAGE SETTINGS
Machine Menu

To select the "MACHINE MENU" option, press the "DOWN" button.

Settings
Credits Menu
BEVERAGE SETTINGS
Machine Menu

Press the "OK" button to enter.

Machine Menu
General Menu
Display Menu
Water Menu

Press the "DOWN" button until the "DESCALING" option is selected.

Machine Menu
Display Menu
Water Menu
Descaling







Press the "OK" button to enter.











At this point, all the already described screens of the descaling cycle will follow.

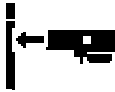







## II TROUBLESHOOTING

### II.1 Warning signals

This chapter describes all the warning messages that the machine may display to the user and the actions that can and/or must be performed by the user.

Warning Signals	How to reset the message
	The machine is starting up.
<p data-bbox="143 547 310 569">PRESS A BUTTON</p>	Machine in Stand-by. Press a button.
	Machine in preliminary warm-up phase to be ready for use.
	Machine in coffee circuit rinse phase. Wait until the machine has completed the cycle.
	The water filter must be replaced with a new one.
	The machine is priming the circuit.
	The machine requires a descaling cycle. When this message is displayed, it is still possible to use the machine, but its correct operation might be affected. Damage caused by failure to descale the machine is not covered by warranty. Upon machine start up, a warning message is displayed for 5 seconds. The descaling cycle can be performed only via the tech. menu.
	The machine indicates that after a few cycles it will be necessary to empty the coffee grounds drawer (see section "Emptying the coffee grounds drawer and drip tray"). The machine still allows to dispense products.

Warning Signals	How to reset the message
 	<p>The credits available to dispense products have run out. All coffee-based products are disabled, and the corresponding LED lights are off.</p>
 5	<p>The selected operation requires milk dispensing. Insert the Cappuccinatore in the machine as specified in the manual.</p>
 1	<p>The selected operation requires milk dispensing. Insert the previously disassembled Cappuccinatore cover into the Cappuccinatore as indicated in the manual.</p>
 4	<p>The selected operation requires milk dispensing. Insert the previously removed valve in the Cappuccinatore as described in the manual.</p>
 	<p>The machine requires cleaning of the Cappuccinatore.</p>
	<p>Group repositioning attempt in progress.</p>
<p>BLUETOOTH INIT PLEASE WAIT</p>	<p>Automatic initialisation of the Bluetooth module. Wait for the machine to complete the operation.</p>
 <p>BLUETOOTH CONNECTED PLEASE WAIT</p>	<p>The machine is connected to the Bluetooth, therefore the keys are not enabled at the moment.</p>
 <p>KEYBOARD LOCKED</p>	<p>The product keyboard has been locked by the operator.</p>
	<p>Flashing symbol. The machine is connected to Bluetooth.</p>

Warning Signals	How to reset the message
	Insert the drip tray and the coffee grounds drawer in the machine.
	To make the machine ready, slightly pull the drip tray and the coffee grounds drawer out, close the service door and place the drip tray and the coffee grounds drawer back in.
	Empty the coffee grounds drawer.
	
<p data-bbox="157 544 303 582">ADD BEANS AND SELECT A BEVERAGE</p>	Fill the coffee bean hopper with coffee beans and select one product.
	Fill the water tank.
	Insert the brew group into its seat.
<p data-bbox="137 818 322 842">RESTART MACHINE</p>	Turn off the machine. Turn it back on after 30 seconds. Try this 2 or 3 times.
<p data-bbox="188 860 272 906"> E<sub>xx</sub></p>	If this signal appears again, contact the service provider and provide the code shown in the display.
	It is an alarm managed by the machine. The machine will perform a cycle of attempts to enter its ready-to-use status. If this is not possible, the machine will signal the error type.
<p data-bbox="132 1018 328 1042">BLUETOOTH ERROR</p> <p data-bbox="199 1074 260 1098"></p>	The Bluetooth module is no longer working correctly. Press the "OK" key to exit the error and be able to use the machine with the product keys.



## 11.2 Problems - Causes - Solutions

The following table indicates the possible error or alarm causes which may lead to a partial or total shutdown of the appliance.

Error code	Description
E01	Error 01: GRINDER_FAIL GRINDER LOCKED It indicates that there is a grinder failure. Coffee grinder broken or not working properly.
E03	Error 03: BU_FWD_FAIL BREWING UNIT LOCKED IN WORK POSITION It indicates that the brewing unit failed to reach the WORK position.
E04	Error 04: BU_RWD_FAIL BREWING UNIT LOCKED IN HOME POSITION It indicates that the brewing unit failed to reach the HOME position.
E05	Error 05: CIRCUIT_CLOGGED_FAIL HYDRAULIC CIRCUIT REFILL FAILED Indicates a fault regarding the water circuit for hot water/coffee: the pump fails to refill the hydraulic circuit.
E06	Error 06: DC_VALVE_FAIL DC VALVE SHORT CIRCUIT It indicates the solenoid valve short circuit
E07	Error 07: DOSER_FAIL BATCHER MICROSWITCH BLOCKED It indicates that the batcher microswitch is blocked or not working properly To restore machine operation, try handling the powder adjusting lever 2/3 times, then switch the machine off and on and try brewing coffee. Contact the assistance service if the problem is not solved.
E10	Error 10: HEATER_SHORT_CIRCUIT_TEMP_SENSOR_FAIL SHORT CIRCUIT BOILER COFFEE TEMPERATURE SENSOR Indicates that the NTC temperature sensor of the coffee boiler is in short-circuit
E11	Error 11: HEATER_OPEN_LOOP_TEMP_SENSOR_FAIL OPEN LOOP BOILER COFFEE TEMPERATURE SENSOR Indicates that the NTC temperature sensor of the coffee boiler is not connected
E14	Error 14: HEATING_UP_TIMEOUT_FAIL TIMEOUT BOILER It indicates that the coffee boiler supply is not connected.
E16	Error 16: BU_SHORT_CIRCUIT_FAIL BREWING UNIT SHORT CIRCUIT It indicates a short circuit in the brewing unit gearmotor.
E19	Error 19: ZERO_CROSSING_FAIL ZERO CROSSING ERROR It indicates a stability problem in the mains frequency that supplies the machine. Check the CPR board connections or replace the board.
E20	Error 20: HEATING_UP_OVER_TEMP_FAIL OVER TEMP BOILER It indicates that the boiler has reached an excessive temperature and has been forcibly switched off.

## 12 STORAGE - DISPOSAL

### 12.1 Location Change

Should the machine be placed in a different location, it is necessary to:

- disconnect the appliance from the supply network;
- carry out the general cleaning of the appliance as indicated in chapter "Cleaning and Maintenance";
- put the parts back into place and close the doors;
- Lift and position the appliance in the assigned location.

### 12.2 Inactivity and Storage

If the appliance needs to be stored or remains inactive for a long period, carry out the same operations as described in section "Location Change", therefore:

- wrap the appliance with a cloth to protect it from dust and humidity;
- make sure that the appliance is installed in a suitable place (temperature must be lower than 1°C) and be careful not to put cartons or appliances on it.

## 13 INSTRUCTIONS FOR END OF OPERATIONAL LIFE DISPOSAL



### INFORMATION TO THE USER

pursuant to Art. 13 of Legislative Decree no. 151 of 25 July 2005 "And in compliance with the provisions of the RAEE Directive relative to the reduction of the use of hazardous substances in electric and electronic appliances, as well as the disposal of the waste".

The crossed-out wheeled bin icon on the appliance or its packaging indicates that the product must be disposed of separately from other waste at the end of its operational life.

Separate collection of the appliance at the end of its operational life is organised and managed by the manufacturer. Therefore, for an appropriate disposal, the user must contact the manufacturer and observe its separate collection management adopted for this appliance at the end of its operational life.

Separating this product for subsequent recycling, treatment and environmental-friendly disposal will help prevent potential environmental and health risks, and allow the materials which make up the appliance to be re-used and/or recycled.

Specific administrative sanctions provided for by current regulations will be applied for illicit disposal of the product by the user.

