

# Golf Club Holiday Tree

## Assembly Manual

For video instructions visit [www.golfclubtrees.com](http://www.golfclubtrees.com)

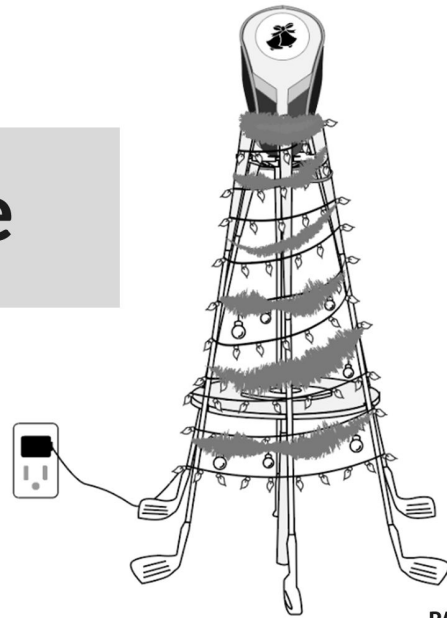

PATENT PENDING

### Package Includes:

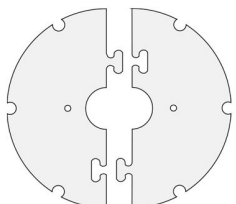

Base (x1)



Bolts (x2)



Wing Nuts (x2)



Rubber band (x1)



Top Insert (x1)



Bottom Insert (x1)



Top Bracket (x1)

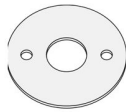

Round Supports (x2)

### You will need:



Club Headcover (x1)

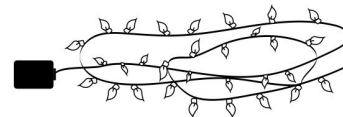

Lights (x1)

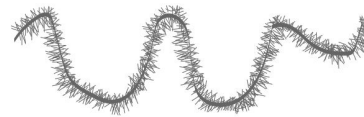

Other Decorations

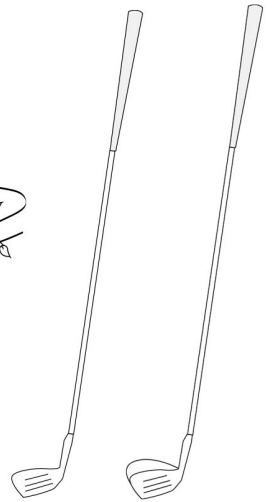

Clubs (x6)

Driver (x1)

1.

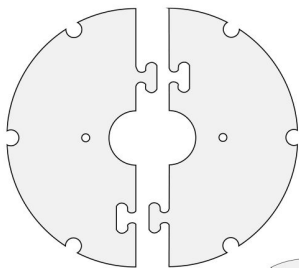

Assemble two halves into a circle.

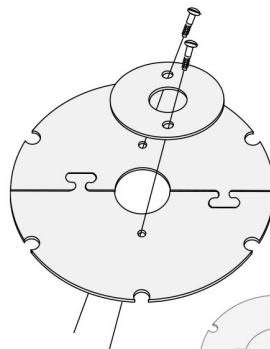

Attach round support pieces on each side of the base using bolts and wing nuts.

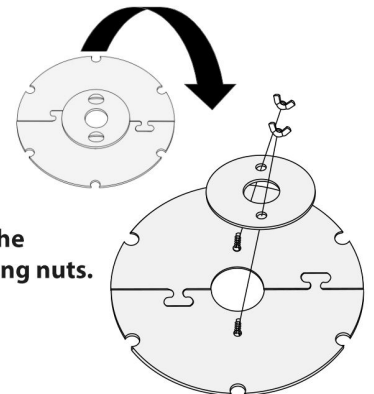

2.

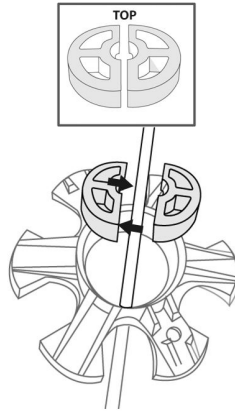
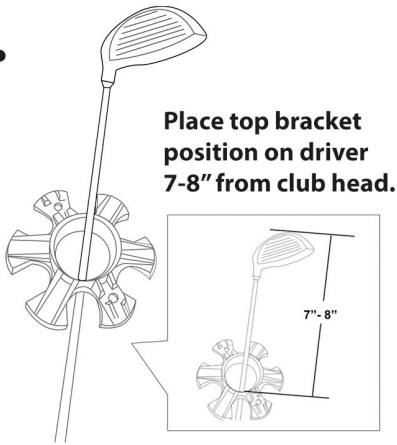

Push in to tighten on shaft.

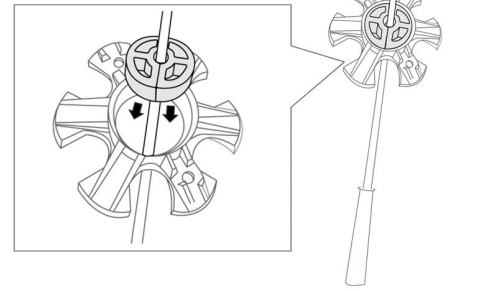

3.

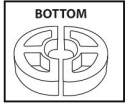

Use bottom inserts to push into hole and tighten against shaft.

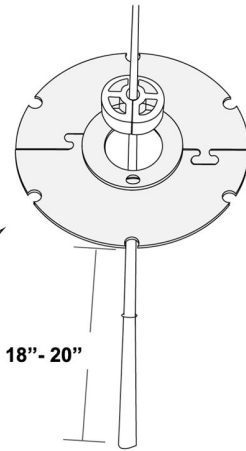
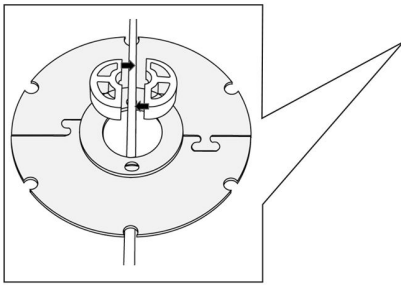

Make sure both top and bottom units are tightly affixed to shaft.

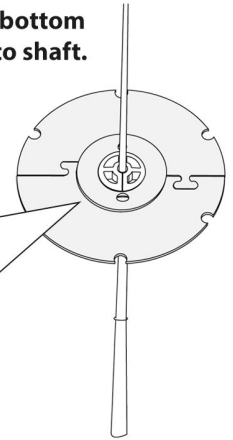
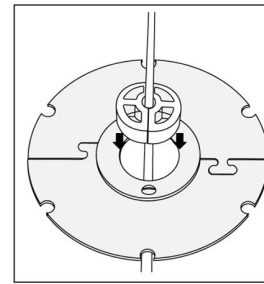

4.

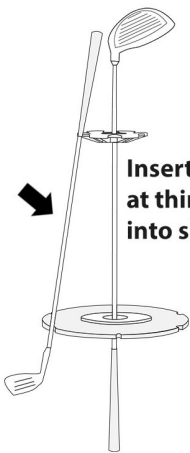

Insert shafts into base at thin area and slide down into slots positioning on floor.

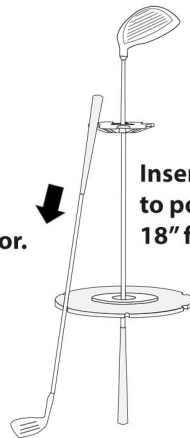

Insert and push to position 18" from floor.

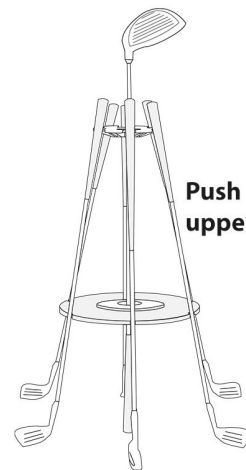

Push grip into upper bracket.

**NOTE:**  
Clubs are different length and grips will set at different positions.

5.

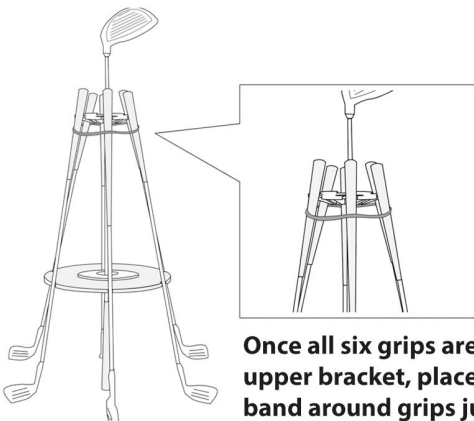

Once all six grips are set in upper bracket, place rubber band around grips just below bracket.

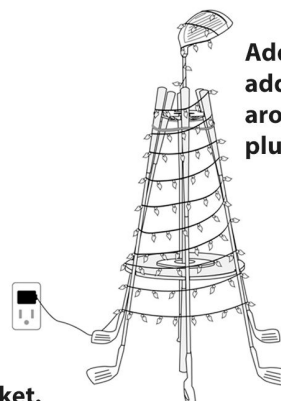

Add headcover and add lights by wrapping around the tree with plug at bottom.

