

L500
Tabletop Low Speed Centrifuge

Instruction Manual

(Read the Instruction Carefully Before Operation)

RCF Calculation Method and Attention for Max. Speed Setting

◆ □ RCF Calculation Method

RCF value is relation to the revolutions per minute and the centrifugal radius; you can apply following formula to calculate:

$$\text{RCF} = 1.118 \times 10^{-5} \times n^2 \times r \quad (\times g)$$

n—speed (r/min)

r—max. centrifugal radius (cm)

g—acceleration of gravity (9.8m/s²)

◆ □ Attention for Setting Max. Speed

The standard max. speed on this product is gotten and verified based on the sample with density 1.2g/ml. The sample means the total contents of any compartment, including specimen, tubes, sealing assembly and adapters. If the density of centrifugation samples is greater than the required 1.2g/ml, the maximum allowable speed for the rotor should accordingly be reduced. It can be calculated by the following formula:

$$N_{\text{max allowable speed}} = N_{\text{max speed}} \times \sqrt{\frac{1.2}{\rho_{\text{actual-density}}}} \quad \rho_{\text{actual density}} \text{ (g/ml)}$$



Note: Here explicitly emphasize that even if the sample mass is less than 1.2g/ml, it is forbidden to increase the maximum allowable speed on the rotor.

In Formula:

Max speed means the maximum allowable speed for sample with density equal to 1.2g/ml.

Please refer to the available rotor on section 2.3 for the standard maximum speed.

Respected Customers:

Thank you very much for using our centrifuge. We are trying our best to provide products with good quality and performance. For easy operation, please read the manual carefully and conduct on the instruction steps before operation.

Whatever questions do you have during operation, please contact us. We will try our best to solve your problems.

Best regards!

This manual tells how to use L500 Centrifuge correctly. Before using (installation, operation, maintenance and inspection etc.) please read the manual carefully. Operate the product after understanding the safety attentions.

Attentions

<p>In order to describe the detailed parts, the graphic illustrations in this manual were shown without outer housing or protective cover. When you using this product, make sure the outer housing or protective cover is installed correctly and operate according to the instructions.</p>

<p>The graphic illustrations in this manual only for explanation, maybe different with the product you purchased.</p>



<p>In order to enhance the convenience and accuracy of the instruction manual, the content of the instruction manual would be changed with the product updating or specification changes.</p>

<p>If the instruction manual is damaged or lost, please contact with the local agent or us directly.</p>
--

Content

Safety in installation and maintenance	4
Chapter 1 Installation and adjustment	9
1.1. Installing requirements and steps	9
1.2. Installation Environment:	9
1.3. Installation Place:	9
1.4. Installation Step:	9
1.5. Centrifuge adjust	10
Chapter 2 Operation instruction.....	11
2.1. Name	11
2.2. Main technical parameters	11
2.3. Rotor options.....	12
2.4. Main Structure and Display Board.....	12
2.4.1. Operation instruction of key	13
1.1.1. Operation instruction of program.....	17
1.1.2. Selection of Centrifugal Mode	18
2.4.2. Operation Steps	19
Chapter 4 Common trouble and trouble shooting.....	22
4.1. Common trouble and trouble shooting.....	22
4.2. Common error code	23
Chapter 5 Transportation and Storage	24

Symbol and its Meanings

Symbol	Meanings
~	Alternating current
ON	Power on(general supply)
OFF	Power off (general supply)
	Protective earthing (ground)
	Warning! (see attachment paper)

Safety in installation and maintenance

 **Attention for safety** clarifies the requirements of safe operation in the instruction manual. Please carefully read it before installation, operation, maintenance and repairing. Understanding the warning and correct operation can avoid the personal injury and the damage of centrifuge.

 We are dedicated to the centrifuge development and improvement, thus our information and data subject to change without notice. Thank you!

 **Rotor Service Life:** Normally 5 years for aluminum alloy rotor and 7 years for titanium alloy rotor. The rotor over service life must be discarded or returned to the factory for inspection.

 It is forbidden to use the rotor with cracks, corrosion or over service life.

 As for the product upgrade or specification changes, some documents which provided by our Company will be change sometimes. We won't inform further, please forgive.

Safety in installation and maintenance

- The electricity should be cut off before repairing. Please take care if instrument must be repaired with electricity on. Before opening any lids, please cut off the electricity and wait for 4mins.
- Make sure for placing centrifuge on a steady floor or table and adjusting the level for normal operation.
- The power supply of centrifuge is the type of nameplate. If you have any problem of the type of power, please consult the dealer and power supply bureau in your place.
- As safety measures, the centrifuge equipped with a single-phase three-wire cable, and the longer cable connects with the casing as the protection grounding. If your socket hasn't protection grounding, please contact your electrician to replace the original socket without allowing security role of single-phase with three-wire power cable to be invalid.
- When replacing parts, the serviceman should use parts manufacturer required with the same function of original parts. The unrecognized alternative parts may cause fire, electric shock or other hazards.
- The room should be installed an air-conditioner for good refrigerating effect when temperature is higher than 35°C.
- Please keep cleaning of the installation site for centrifuge. Pay attention to the blockage of condenser, it should be cleaned once in three months for guarantee the refrigerating effect.
- Don't unpack and repair instrument by oneself. Please contact with our technicians for necessary matter.

Attention for electric system

- ·To reduce the risk of electric shock, the centrifuge adopts the plug with three points which must connect with the socket with ground lead.
- ·Make sure if the wall socket is connect with the ground wire. The voltage of power supply must accord with the voltage of centrifuge.
- ·Don't use the power adapter from three holes to two holes.
- ·It is forbidden to use the expanding socket with two lines or all-purpose power adaptor without ground wire.
- Don't put container with liquid on the centrifuge or around the centrifuge. If the container is knocked over, the liquid will infiltrate into centrifuge and damage the electrical or mechanical parts.

Attention for fireproofing

- Small breaker (air switch) can protect the circuit when centrifuge over-currents. Please use the breaker (air switch) with same specification and model when replacing it.
- The centrifuge is not designed for the flammable and explosive matters. You cannot make centrifugation for the matters (chloroform, acetaldehyde), and cannot put the matters in the centrifuge or store them around centrifuge within 30cm.

Attention for safe operation

- Please use the rotor and accessories which are designed for this centrifuge
- Please check rotor, buckets and other accessories carefully before operation.
- Input the right rotor number before operation for not exceeding of its max speed. **Attention:** The max speed of rotor, buckets and accessories may be different.
- Make sure that rotor can be installed on main spindle correctly for not damaging the spindle part.
- Put all buckets (The same model) in rotor before operation for not exceeding its max imbalance volume, close the rotor lid then.
- Make sure if the centrifugal chamber is cleaned before operation.
- Don't reduce the speed by hand when it is rotating.
- Don't open door lid when rotor is rotating.
- Don't move centrifuge lid when rotor is rotating.
- Anything is not allowed to enter into centrifuge during operation.
- If tube is broken in centrifugal chamber, please clean out the fragments before next operation.
- If there is water condensing in centrifugal chamber, please wipe up it with clean cloth.
- The container with liquid should not be put around centrifuge; the electric parts may be damaged for water spraying in.
- If centrifuge is irradiated by ultraviolet radiation for long time, the outer skin may be faded. Clothing should be covered for avoiding irradiation.
- This centrifuge must not be used to separate the sample which producing flammable and explosive gas. The stock around centrifuge is also forbidden.

- Check rotor and buckets carefully before installation. It is forbidden to use the cracked rotor and buckets, otherwise user should answer for all consequence.
- It is forbidden to operate the rotor exceed of its max speed. If user has not set rotor type according with the number on rotor lid, all damages caused by above disoperation should be borne by user.
- Please wipe up the rotor with neutral cleaning mixture after taking out for avoiding corrosion and then stock it at dry, ventilated place. Central hole in rotor should be smeared some lubricating grease for protection.
- All action on rotor should be soft, and rotor should be taken out vertically for protecting the shaft.
- Please wipe up the water in centrifugal chamber if it is leaving unused. Some lubricating grease should be smeared on drive shaft for protection.
- The interval of between two operations is no less than 5 minutes for avoiding damage of compressor.
- If rotor damage occurring, allowable space to move for centrifuge is 30cm. Anything should not be put around centrifuge within 30cm, especially for flammable and explosive matter. It is not allowed to lean on the centrifuge when it is running. Non-staff are not allowed to stay in the operation area.
- When unpacking rotor and replacing rotor accessory and sample under low temperature, the operator must adopt protection actions for avoiding tissue frostbiting.
- Centrifuge must be stopped when any abnormal phenomena occurring or error code displaying, then you should inform our company or service agent soon.

Attention for safety in chemistry and biology

The routine manipulation may include all kinds of liquid and test sample which may be the disease-causing and poisonous matters. The centrifuge cannot be manipulated with the matters unless you have toke the protection measures.

- Please pay attention to the liquid explanation in container before operation.
- Be careful of the infectious liquid. If not understanding the provided sample, please at least make sure that they aren't microbe. You must make further aerosol protection (the suspended speck in the air, such as smoke and fog.) for the easier disease-causing hepatitis virus(B or C), HIV, atypical mycobacteria and the fungus of physical structure.
- The infectious samples must be manipulated according to the manipulating program and method in lab for avoiding expanding disease.
- The spilt matters may produce aerosol (the suspended speck in the air, such as smoke and fog.) , so please

pay attention to the warning about aerosol (the suspended speck in the air, such as smoke and fog.)

- **Only use the suitable rotor and adaptor.** The centrifuge cannot be manipulated with disease-causing, poisonous or radioactive matters unless you have taken the protection measures. When the second type of hazardous substances (according to “Laboratory Biosafety Manual” of the World Health Organization.) is manipulated, the air safety level must be monitored. The superior substances require a higher level of safe protection measurements.
- You should follow the environment security and protection requirements when destroying the discarded liquid.
- **Users have the responsibility to clean and sterilize centrifuge and accessory if you need maintenance service from our company.**

In a word, centrifuge is the high-risk common equipment in the lab which refers to safety of people. Correct operation can avoid and reduce accidents.

Chapter 1 Installation and adjustment

1.1. Installing requirements and steps



Warning: Don't install centrifuge in the place with flammable and explosive matters. The flammable and explosive gas comes into the running centrifuge, which may lead to fires. Checking the Centrifugal Chamber, do not use the centrifuge before installing the centrifuge properly, otherwise it will damage the centrifuge.

1.2. Installation Environment:

- ◆ The working environment temperature is 10°C to 35°C, and the relative humidity is no more than ≤85%.
- ◆ It is prohibited to put lab equipment with large heating production and strong vibration around centrifuge.
- ◆ Avoid direct sunlight and damp places.
- ◆ Avoid installing in the place of corrosion, flammable and explosive gases in the air.
- ◆ Avoid installing in oil, dust, and metal dust places.

1.3. Installation Place:

- ◆ The centrifuge should be installed on the flat and solid platform.
- ◆ The distance between centrifuge and wall should be kept 30cm at least for air circulation.

1.4. Installation Step:

- ◆ Please check whether the Package is complete or not, if there is any damage, please contact with our company directly.
- ◆ Open the outer package, carefully take out the centrifuge with foam package, then put it on the even platform and take off the foam package. The four rubber feet of centrifuge should touch with platform evenly.
- ◆ Open the Lid: Poke into the Emergency lock hole by using the inner hexagon spanner which along with

the centrifuge Tools, aim at the Inner six angle Lock hole of the centrifuge, clockwise rotate to open the Lid. Then check the chamber of the centrifuge, and take all the things from the chamber, and clean the Chamber.

- ◆ Checking the Packing list to see whether the Main Machine, Accessories, Tools and Files are complete or not.
- ◆ Rotor install: Take the Rotor out of the package, and check whether the Rotor is ok and without any damage or deformation during the transport. Hold the Rotor by hand; put the Rotor on the Rotor shaft vertically and stably. Then one hand holds the Rotor Yoke, other hand screw the Rotor tightly by the spanner. You must make sure the Rotor is installed tightly before use.
- ◆ You must confirm the voltage of the power supply and the voltage of the centrifuge require is the same. Connect the power cord to the electric outlet on centrifuge back first, and then put the plug on the other end into the external electric supply socket. Press one side marked “-” on the switch to power on.

1.5. Centrifuge adjust

- ◆ According to the different centrifuge Operation steps to operate. Before use, please whether the Rotor is loose, the centrifuge is on the plat without any shack. If all is OK, then close the Lid. If everything is ok, then start the centrifuge directly (do not use sample in the Rotor to use). The Max Speed setting is 1000r/min, when run to 1000r/min, then stop, set 2000r/min, when run to 2000r/min, then stop to set 3000r/min, 4000r/min and 5000r/min, until to the Max speed of the Main Machine(L500 is 5000r/min). If there is no abnormal phenomenon, then you can use it.
- ◆ Then use the Rotor with its Max Load (Fill with the Full Capacity), use Swing Rotor, and then press the tube hanger to check whether there is any no abnormal phenomenon. If everything is normal, then start to run, first set 1000r/min, when run to 1000r/min, then stop, set 2000r/min, when run to 2000r/min, then stop to set 3000r/min, 4000r/min and 5000r/min, until to the Max speed of the Main Machine(L500 is 5000r/min). If there is no abnormal phenomenon, then it is successful in Adjustment.

Chapter 2 Operation instruction

2.1. Name

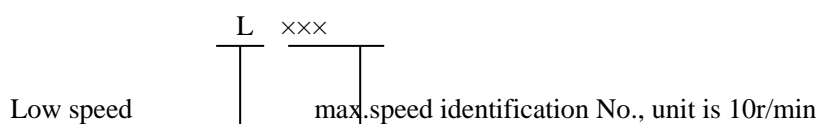

For example, L500 tabletop low speed centrifuge whose Max.speed is 500×10r/min.

Figure 2.1-1、 Name Rule

2.2. Main technical parameters

Model Name	L500
Max speed	5000r/min
Max RCF	4030 ×g
Max Capacity	16×15ml
Rotors supply by contract	
Net Weight	19Kg
Dimension (L×W×H)	370mm×432mm×250mm
Power Supply	AC110V 50/60Hz 5A
Time range	1~99min
Speed Accuracy	±30r/min
Noise	< 65dB (A)

Figure 2.2-1、 2.2.Main technical parameters

2.3. Rotor options

You can choose, use and set the max speed, Max RCF and Max Capacity according this table.

Model Name	Rotor No.	Max speed	Max RCF	Rotor name	Capacity
L500	NO.1	5000r/min	4030×g	Angle Rotor	24×10ml
	NO.2	4200r/min	2760×g	Swing Rotor	4×50ml
					16×15ml
					24×5ml

Figure 2.3-1、Rotor options

2.4. Main Structure and Display Board

L500 Tabletop Low speed centrifuge composed of the main machine and accessories. The main machine is composed of Shell, centrifugal chamber, drive system, control system and the part of manipulation display. The rotor and centrifugal tube (bottle) belong to accessory (provide according to contract).

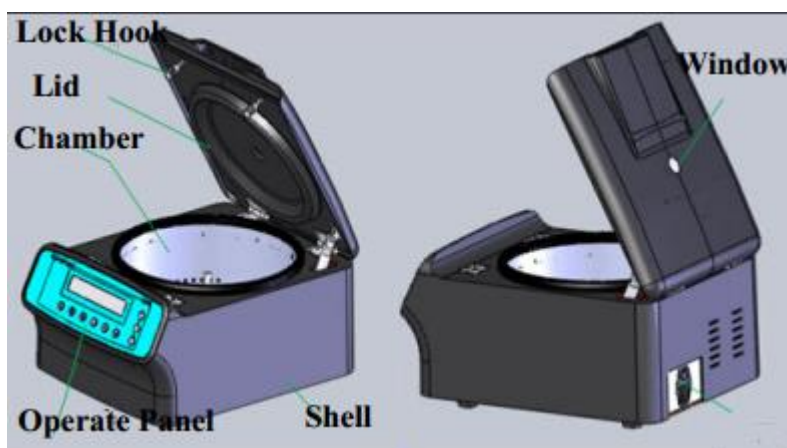

2.4.1. Operation instruction of key



Figure 2.4-2、Display Board

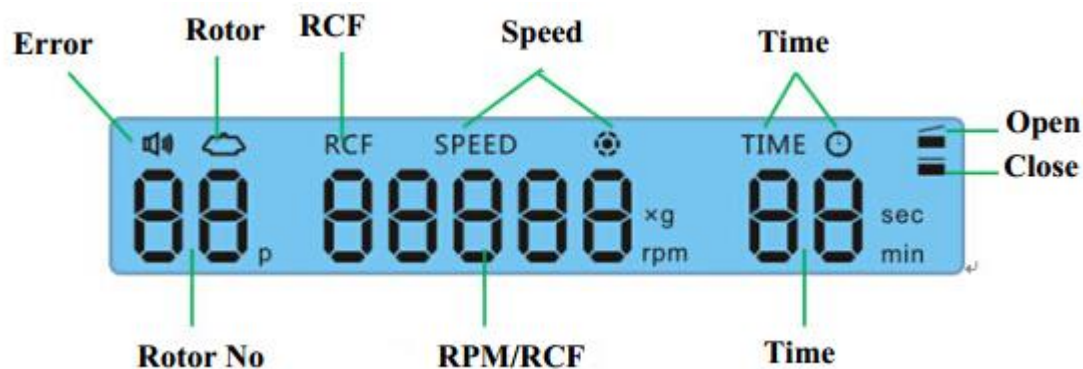











































Figure 2.4-3、LCD Display



Indicator light status and meaning

- Light off
- Light on, it means the choose the program or display the process which will run; For example: The Indicator Light become green flash, then it means that the centrifuge is start, and it is on the state of speed us. The light keep green all the time means the centrifuge is running under the set speed. If the indicator Light becomes red flash, then it means that the centrifuge is stop and it is on the state of speed down. If the light keeps red all the time, then it means the centrifuge is totally stop.









	“Set” Key
	<ul style="list-style-type: none"> ◆ Press  key, then the number of the Rotor No. Will flash, then it enter into the rotor No. Setting mode, press the  or  key to choose the Rotor No you use. Attention: When the centrifuge is running, do not try to set this. ◆ Press  Key, then the number of speed area will flash, then it enter into the speed setting mode, press  or  to set the speed you want. Attention: The speed you set shouldn't excess the Max speed of the Rotor you use. ◆ Press  Key, then the number of time area will flash, then it enter into the time setting mode, press  or  to set the time you need. ◆ Press  Key, then the number of display area of  will flash, it can set the Acc gear you need, press  or  key to set the gear you need, from 1 to 9 gears, the number is larger, then Acc time will be less, at normal, it set to 5. ◆ <input type="checkbox"/> Press  Key, then the number of display area of  will flash, it can set the Acc gear you need, press  or  key to set the gear you need, from 0 to 9 gears, the number is larger, then Dec time will be less, at normal, it set to 5.

	<p>“Start” Key</p>
	<ul style="list-style-type: none"> ◆ Press  Key, the Indicator Light will become green flash, start the centrifuge, it will run to the parameter you set, and then the Light will keep green.
	<p>“Stop” Key</p>
	<ul style="list-style-type: none"> ◆ When the centrifuge is under running, then  Key, then the Indicator light will become red flash, it will reduce from the max speed to “0”, when the Light keep red, then the centrifuge totally stop. ◆ The centrifuge connect the power, but on the not work mode (the rotor is not running), the press  Key, the Lid will be open. ◆ When the display Board display the Error code, press the  Key, Clear error code.
	<p>“RCF” Key</p>
	<ul style="list-style-type: none"> ◆ Press  key, it will display RCF of the Rotor you use and the speed you set, RCF display on the speed display area, in order to distinguish, the decimal point will show.
	<p>“Prog” Key</p>
	<ul style="list-style-type: none"> ◆ 、、、、 those keys use together can realize the program choose and amend.
 	<p>“Add/Reduce” Key</p>
	<ul style="list-style-type: none"> ◆ Press  key, it can add the value of the setting parameter. ◆ Press  Key, it can add the value of the setting parameter.







	<h3>“Enter” Key</h3>
	<ul style="list-style-type: none"> ◆ Press  key to confirm the parameter you set. At normal, press the  key to set the Rotor No, speed, time, Acc/Dec you need, then press  key, it will store all kinds' parameters you have set. ◆ If you set the parameter, not press  to confirm exceed 5 seconds, then it will be invalid and back.

	<h3>“Pulse” Key</h3>
	<ul style="list-style-type: none"> ◆ Press  Key, the centrifuge will run, not press, then centrifuge will stop automatically, it is for short short-time centrifugation.

1.1.1. Operation instruction of program

Operation instruction of program		
condition	Display	Function Description
Select	01 p	<p>◆ Select program: when the centrifuge is power on but not work, press the , then “01_p” number will flash, then press  or  to select the program No. you need (there is 25 preset program, from 1 to 25, together 25 programs), then press the  key to confirm your selection.</p> <p>◆ Not press  to confirm exceed 5 seconds, then it will be invalid and back.</p>
Amend	01 p	<p>◆ Amend program: amend the program parameter, press the  key, please refer to the operation instruction of centrifuge program set, set the Rotor No, speed, time, temp, Acc gear and Dec gear, then press the  to confirm you set, then the program will be saved automatically.</p> <p>◆ Not press  to confirm exceed 5 seconds, then it will be invalid and back.</p>

1.1.2. Selection of Centrifugal Mode

Operation of Centrifuge Mode		
Item	Condition and Display	Function Description
1	<p>Timed centrifugal mode</p> <p>TIME ⌚</p> <p>20 min</p>	<p>Press  key, set ^{TIME ⌚} 20 min the time to any number you need from 01 to 99(Timed centrifugal mode), and then press the  key to start the centrifuge, the Indicator Light will become green. After the speed up to the max speed you set, the time will start to countdown (99 to 00), the time unit is minute. When the time countdown from the time you set to the “0”, the centrifuge will stop automatically, and the Indicator Light will become red.</p> <p>When the speed reduces to 0 r/min, then the centrifuge will have Buzzer sound for times.</p>
2	<p>Short-time centrifugal mode</p> <p>TIME ⌚</p> <p>20 min</p>	<p>Press the  Key, the centrifuge will run, not press, then centrifuge will stop automatically, it is for short short-time centrifugation.</p>
3	<p>Continue centrifugal mode</p> <p>TIME ⌚</p> <p>Hd</p>	<p>Press  key, set the ^{TIME ⌚} 20 min to the max number “99” (Continue centrifugal mode). Press  key to start the centrifuge. The time display area will display to “Hd”, the run time will from 00 to 99, Cycle time count, the time unit is minute. Until you press the  key, the centrifuge will stop.</p>

2.4.2. Operation Steps



1. Checking the Rotors and Tubes: Before you use, please check the rotors and tubes carefully. It is forbidden to use the cracked and damaged rotors and tubes; it may cause the machine damage.
2. Install Rotor: Take the Rotor out of the package, and check whether the Rotor is ok and without any damage or deformation during the transport. Hold the Rotor by hand; put the Rotor on the Rotor shaft vertically and stably. Then one hand holds the Rotor Yoke, other hand screw the Rotor tightly by the spanner. You must make sure the Rotor is installed tightly before use.
3. Add Liquid in the tube and put the tube: When add the sample in the centrifuge tube, it should use the balance to measure the same weight, then put into the tube symmetrically, in the rotor the weight of the symmetrical tube should be the same weight. The centrifugal tube should put symmetrically, otherwise, there will be vibration and noise because of imbalance.(Attention: the tube put should in even number, such as 2, 4, 6,8 and so on)
4. Lid close: Put the Lid down, when the Lock hook touch the inductive switch, the Lid will automatically lock. When the display board display the Lid in the close mode, and then it means that the centrifuge is closed.
5. Set the parameter of the Rotor No, speed, time, Acc, Dec and so on.
6. Start and Stop the centrifuge:



Warning: Before inspect the chamber and take out of all materials except for the rotor, do not start the centrifuge. Otherwise, the centrifuge may be damaged.



Warning: It is forbidden to run the rotor exceed of its max speed, because over-speed may cause instrument damage and even the personal injury.

- a) Start: Press the  key to start the centrifuge, and then the Start Indicator Light will be light.
- b) Automatically stop: When the time count down to “0”, the centrifuge will slow down and stop automatically . When the speed is 0r/min, you can open the Lid Lock.
- c) Manually stop: In the running status (the working time isn’t counted down to “0”), press the  key, the centrifuge will start to stop, when the speed slow down to 0 r/min, you can open the

Lid.



Attention: When the centrifuge is running, while the Power is suddenly off , it will cause the electrical lock can't work, so the Lid can't open. You must wait the speed stop to 0 r/min, then open the by Emergency way (Poke into the Emergency lock hole by using the inner hexagon spanner which along with the centrifuge Tools, aim at the Inner six angle Lock hole of the centrifuge, clockwise rotate to open the Lid).

7. Uninstall the rotor: When replacing the rotor, you should uninstall the used rotor, unscrewing the bolt with screwdriver and take out the rotor after removing spacer.

8. Shut off the Power: When the work is finished, then shut off the power and pull off the plug.



After the last using of the Rotor every day, you should uninstall and take the rotor out.

Chapter 3 Service and maintenance

- Please wipe up the rotor with neutral cleaning mixture after taking out for avoiding corrosion and then stock it at dry and ventilated place. Central hole in rotor should be smeared some lubricating oil for protection.
- All action on rotor should be soft, and rotor should be taken out vertically for protecting the shaft.
- Please wipe up the water in centrifuge chamber if it is leaving unused for long time. Some lubricating oil should be smeared on drive shaft for protection.
- Replace fuse

(1) Cut off the power, and unplug the plug the power cord connected with the external electric supply socket.

Then draw another end of the power cord connected with the centrifuge.

(2) There is a fuse case equipped on the under part of electric outlet on instrument back. (See figure 3) There is a marking for fuse symbol, and find the V-shape slot on fuse case. (See figure 4) Pull out the fuse case with slotted point screw driver into the V-shape slot.

(3) Take out the damaged fuse and replace it. The model of fuse of the centrifuge is BGXP 5×20 、 250V 10A.

(4) Put the fuse case into electric outlet.

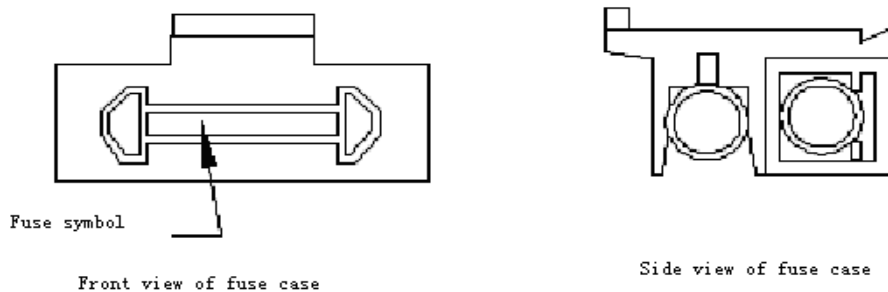

Figure 3

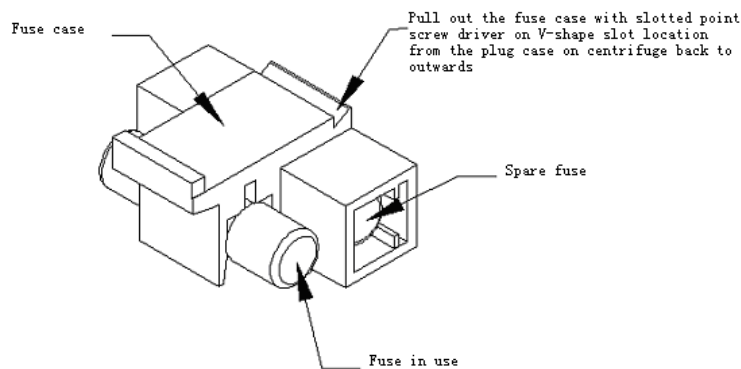

Figure 4

Chapter 4 Common trouble and trouble shooting

4.1. Common trouble and trouble shooting

During operation, maybe there are following failures, please refer to following methods for easy troubleshooting:

◆ **Power on but no display:**

- 1) Check whether the input power is accordance with centrifuge rated voltage by multimeter. If it is the power problem, check and troubleshooting.
- 2) Check whether the power cord is connected with the mains jack. If it is loosen and not connected properly, check and troubleshooting.

◆ **Loud noise or abnormal vibration:**

- 1) Check whether symmetrically placed tubes are with same weight. If the weight does not meet the tolerance requirement, please balancing weight again and make sure symmetrically placed tubes with the same weight.
- 2) Check whether the tube is broken or no. If it is, clear the rotor and place it with the same weight tube.
- 3) Check whether the tubes are symmetrically placed in the rotor. If not, please place them symmetrically.
- 4) Check whether the centrifuge is placed on a steady platform in level and the stress on four foot is in even or not.
- 5) Whether the rotor is bend or not. Whether the ground is stable and there is strong shock around.
- 6) Check whether damping absorber parts are damaged or not. If it is, replace them. (Please conduct under the instruction of professional service engineer.

◆ **Centrifuge not work:**

- 1) Check whether connecting terminals is connected with circuit board properly and the connection is loose or not. If it is, please fasten the connection wires properly.
- 2) Check whether the input/output voltage is correct with multimeter. If the power supply transformer is broken, please replace it with the same model and specification transformer.
- 3) Check whether the motor is energized with multimeter. If the motor is energized but not rotate, it means the motor is damaged and replace it.
- 4) If the motor can rotate but the rotor does not spin, please check whether the rotor is installed correctly. If no abnormal on the rotor, please contact our service engineer.

For above four failures, please contact the local agent or our company directly, and do troubleshooting under professional engineer's instructions.

4.2. Common error code

Error code	Reasons	Solution
E5	The door lid isn't closed or the door opened abnormally during run	Check and Close door lid
E6	Overspeed, rotor number setting wrong or power control board cannot be controlled	Check and replace
	Motor was damaged	Replace
E7	Motor runs without speed, power control board cannot be controlled or no rated power supplied	Check and replace
	The speed-detecting signal wire was loosened	Check and replace
E9	Communication failure, the connecting wire between display board and power control board was loosened or damaged.	Check and replace

Attention: If the centrifuge has any problem like the above, please try to contact with our company after-sale service department first.

Chapter 5 Transportation and Storage

5.1 Transportation

- You should use the wooden case and carton during long-distance transportation. Put centrifuge with dust cap into the case, and fill with foam or plastic shock absorption materials. It is forbidden to be hit, inverted, rolled and soaked by rain and snow.
- You can directly move the centrifuge in room, but avoid big vibration, hitting and inversion.

5.2 Storage

- If it is leaving unused for long time, you should open the door lid and store it in ventilated, dry and clean room where is no corrosive, flammable and explosive matters.
- As the technology continuously renews, please consult us if there is something unconformable with this instruction manual.

Warranty

Respected customers,

Thank you for purchase of our company's products. To protect your legal rights and avoid your worries, we provide warranty service for one year with the main machines. If it is broken under warranty with inartificial reason, we will supply free maintenance service. The customer needs to pay an amount of money if the product has exceeded the warranty period. We will not supply free maintenance if any following matter is happened:

- Exceed of the warranty period or without the warranty card.
- The trouble is caused by wrong installation, operation and maintenance.
- The trouble is caused by the unauthorized uninstalling and repairing by our company.
- The trouble is caused by using the rotor not equipped with this centrifuge.
- The trouble is caused by war, natural disasters or other irresistible factors.

Packing List

Item	No	Name	Quantity	Unit	Remark	Check
Main machine	1	L500	1	set		
Option of rotor and accessories	2	Fuse BGXP 5×20 250V 10A	5	pc	Two in fuse case	
	3	Power cord	1	pc		
	4	4x50ml swing rotor	1	set		
Attached tool	1	17-19 mm open end wrench	1	pc		
	2	T-shaped inner hexagon spanner	1	pc	Lid Release	
	3			pc		
Attached file	1	Packing List	1	copy		
	2	Instruction Manual	1	copy		
	3	Qualified Certificate	1	copy		
	4			copy		

Quality Certificate

Product Name: Tabletop Low Speed Centrifuge

Product Model: L500

Serial No.: _____

This product is tested and qualified for delivery.

Checker:

Date: