

CLT55

Tabletop Low Speed Large Capacity Centrifuge

User's Manual

(Read the Instructions Carefully Before Operation)

RCF Calculation Method and Attention for Max. Speed Setting

◆ □ RCF Calculation Method

RCF value is relation to the revolutions per minute and the centrifugal radius; you can apply following formula to calculate:

$$\text{RCF} = 1.118 \times 10^{-5} \times n^2 \times r \quad (\times g)$$

n——speed (r/min)

r——max. centrifugal radius (cm)

g——acceleration of gravity (9.8m/s²)

◆ □ Attention for Setting Max. Speed

The standard max. speed on this product is gotten and verified based on the sample with density 1.2g/ml. The sample means the total contents of any compartment, including specimen, tubes, sealing assembly and adapters. If the density of centrifugation samples is greater than the required 1.2g/ml, the maximum allowable speed for the rotor should accordingly be reduced. It can be calculated by the following formula:

$$N_{\text{max allowable speed}} = N_{\text{max. speed}} \times \sqrt{\frac{1.2}{\rho_{\text{actual-density}}}} \quad \rho : \text{actual density (g/ml)}$$

If use the stainless steel carrier and stainless steel tube cap, the max allowable speed for the rotor should accordingly be reduced. Usually the reduced allowable speed is the 75% of the original max. speed. So, we can determine the max. allowable speed by the following formula:

$$N_{\text{max allowable speed}} = N_{\text{max. speed}} \times \sqrt{\frac{WA}{WB}}$$

WA: The total weight of the specific aluminum cap for rotor, plastic tube, solution under the density 1.2g/ml.

WB: the actual weight of the actual used centrifugal tube, tube cap and solution.



Note: Here explicitly emphasize that even if the sample mass is less than 1.2g/ml, it is forbidden to increase the maximum allowable speed on the rotor.

In Formula:

Max speed means the maximum allowable speed for sample with density equal to 1.2g/ml.

Please refer to the available rotor on section 2.3 for the standard maximum speed.

Respected Customers:

Thank you very much for using our centrifuge. We are trying our best to provide products with good quality and performance. For easy operation, please read the manual carefully and conduct on the instruction steps before operation.

Whatever questions do you have during operation, please contact us. We will try our best to solve your problems.

Best regards!



This manual tells how to use CLT55 centrifuge correctly. Before using (installation, operation, maintenance and inspection etc.) please read the manual carefully. Operate the product after understanding the safety attentions.

Attentions
<p>In order to describe the detailed parts, the graphic illustrations in this manual were showed without outer housing or protective cover. When you using this product, make sure the outer housing or protective cover is installed correctly and operate according to the instructions.</p> <p>The graphic illustrations in this manual only for explanation, maybe different with the product you purchased.</p> <p>In order to enhance the convenience and accuracy of the instruction manual, the content of the instruction manual would be changed with the product updating or specification changes.</p> <p>If the instruction manual is damaged or lost, please contact with the local agent or us directly.</p>

Table of Contents

Safety Information	5
Chapter 1 Installation and Adjustment.....	8
1.1 Inspect the centrifuge.....	8
1.2 Identify the Installation Environment	8
1.3 Installation Site	8
1.4 Installation Steps.....	9
1.5 Centrifuge Trial Operation.....	12
Chapter 2 Operating Instructions	13
2.1 Naming Rule	13
2.2 Main Technical Parameters	13
2.1 Rotor Option	14
2.4 The Internal Structure and Parts Name of Main Machine	15
2.4.1 The Basic Structure of Main machine CLT55	15
2.4.2 Driving System	15
2.5 Operation Steps.....	16
2.6 Use of Spare Wrench	19
2.7 Control Panel Operating Instructions.....	22
2.7.1 The Control panel operating instructions of CLT55	22
2.7.2 Main interface operation instructions	22
2.7.3 Operation Steps.....	25
Chapter 3 Service and Maintenance	35
3.1 Centrifuge (casing, lid and chamber).....	35
3.2 Rotor and accessories.....	36
Chapter 4 Common trouble and trouble shooting.....	39
4.1 Common trouble shooting.....	39
4.2 Protection mechanism and Error code analysis	41
Chapter 5 Transportation and Storage.....	48
5.1 Transportation	48
5.2 Storage	48
Warranty.....	49
Packing List	50
Quality Certificate.....	51
Product Warranty Card.....	Error! Bookmark not defined.
Users Feedback Card.....	Error! Bookmark not defined.

1.Symbol and its meanings

Symbol	GB No.	Meanings
~	4706.1	Alternating current
	5465.2	Power on(general supply)
○	5465.2	Power off (general supply)
	4728.2	Protective earthing(ground)
	4793	Warning: Safety caution

Safety Information

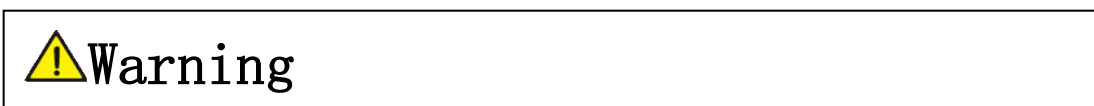

 **Safety Information** clarifies the requirements of safe operation in the instruction manual. Please carefully read it before installation, operation, maintenance and repairing. Understanding the warning and correct operation can avoid the personal injury and the damage of centrifuge.

 We are dedicated to the centrifuge development and improvement, thus our information and data subject to change without notice. Thank you!

 **Rotor Service Life:** Normally 5 years for aluminum sheet rotor, 6 years for aluminum alloy rotor, 10 years for titanium alloy rotor and 10 years for fiber carbon rotor. The rotor over service life must be discarded or returned to the factory for inspection. If the centrifugal sample is corrosive or the rotor is not cleaned and maintained as required, the service life of the rotor will be reduced; it is necessary to regularly check whether the rotor has cracks, corrosion pots, deformation and other adverse conditions.

 **Centrifuge main unit Service Life:** the service life of the centrifuge main unit is 8 years; the centrifuge over the service life must be discarded or returned to the factory for inspection before use. If the centrifugal samples are corrosive or the centrifuge is not cleaned and maintained as required, the service life of the centrifuge will be reduced; it must be checked regularly by professional person.

 It is forbidden to use the rotor with cracks, corrosion or over service life.

Attention for installation and maintenance

- ◆ The rotor accessory and package may be placed in the centrifugal chamber. You should open the door lid to check and take out while installing.
- ◆ In the machine maintenance process, the parts that need remove cover may cause electrical shock or personal injury. Ensure that the power has been cut off and the power line has been removed from the socket, and qualified staff manipulates it.
- ◆ The replaced part must be consistent with the requirements of this centrifuge. If you are not sure, please contact our after service department.

Attention for electric system

- ◆ To reduce the risk of electric shock, the centrifuge adopts the plug with three points which must connect to the socket with ground lead.
- ◆ Make sure if the wall socket is connect with the ground wire. The voltage of power supply must accord with the voltage of centrifuge.
- ◆ Don't use the power adapter from three holes to two holes.
- ◆ It is forbidden to use the expanding socket with two lines or all-purpose power adaptor without ground wire.
- ◆ Don't put container with liquid on the centrifuge or around the centrifuge. If the container is knocked over, the liquid will infiltrate into centrifuge and damage the electrical or mechanical parts.
- ◆ Before moving the centrifuge, make sure to power off the centrifuge, in order to avoiding the possible damages caused by electric shock.
- ◆ If the centrifuge is damaged, please do not repair it by yourself. Please contact the professional technician in your company or distributor and our service engineer to handle it.

Attention for fireproofing

- ◆ Please use the overload fuse with same model and specification.
- ◆ The centrifuge is not designed for the flammable and explosive matters. You cannot make centrifugation for the matters (chloroform, acetaldehyde), and cannot put the matters in the centrifuge or store them around centrifuge within 30cm.

Attention for safe operation

- a) Please use the rotor and accessories which are designed for this centrifuge by our company. It is forbidden to use the rotor and accessories with cracks, corrosion or over service life.

- b) Make sure if the centrifugal chamber is cleaned before operation. Make sure if the screw (nut) of the rotor in the centrifugal chamber has been screwed down.
- c) Not exceed its max speed of rotor during operation. Don't decelerate rotor speed or stop by hand. Don't open the door lid during centrifugation.
- d) Don't hold or move centrifuge when rotor is rotating.
- e) If the glass test tube is cracked in centrifuge chamber, please carefully check and clean the gasket and centrifugal chamber because the glass fragment may have inserted into their surface.
- f) The distance between centrifuge and other objects must be kept 30cm during operation. You should not stand around centrifuge within 30cm unless adjusting it. Anything is not allowed to enter into centrifuge during operation.

Attention for safety in chemistry and biology

- ◆ The routine manipulation may include all kinds of liquid and test sample which may be the disease-causing and poisonous matters. The centrifuge cannot be manipulated with the matters unless you have taken the protection measures.
- ◆ Please pay attention to the liquid explanation in container before operation.
- ◆ Be careful of the infectious liquid. The infectious samples must be manipulated according to the manipulating program and method in lab for avoiding expanding disease.
- ◆ You should follow the environment security and protection requirements when destroying the discarded liquid.
- ◆ Users have the responsibility to clean and sterilize centrifuge and accessory if you need maintenance service from our company.
- ◆ Always be aware of possibility of contamination when using radioactive, toxic, or pathogenic materials. Take all necessary precautions and use appropriate decontamination procedures if exposure occurs.
- ◆ The use of sealed rotors, buckets and/ or sample containers will provide increased protection from contamination during routine operation. However, these items will not guarantee contamination protection from accidents resulting in damage to the rotor or buckets. Do not run hazardous materials in the centrifuge unless placed in a biohazard enclosure and operated using all appropriate safety precautions.
- ◆ Never use any materials capable of producing flammable or explosive vapors, or extreme exothermic reactions.

Chapter 1 Installation and Adjustment

1.1 Inspect the centrifuge



Warning: Do not install the centrifuge around the place with flammable or explosive materials. Before power on, please open the door lid by door emergency release tool and check the chamber. Please do not power on before taking out the matters in the chamber.

1.2 Identify the Installation Environment

The surrounding environment would have extent impact on the centrifuge service and performance. The centrifuge must be installed in the following conditions:

- ◆ It must be installed indoor.
- ◆ Environment Temperature and Humidity: The working environment temperature is 5°C to 35°C, and the relative humidity is no more than $\leq 80\%$.
- ◆ The atmospheric pressure is 86kpa to 106kpa;
- ◆ It is prohibited to put lab equipment with large heating production and strong vibration around centrifuge.
- ◆ Avoid installing in the areas with humidity and direct sunlight or other heat source direct radiation.
- ◆ Pollution level: 2 grade; Avoid installing in the areas with greasy dirt/dust/metal dust, corrosive, flammable or explosive gas.
- ◆ There is no strong vibration and air flow around.

1.3 Installation Site

- ◆ When centrifuge is in operation, the rotor and its accessories is in the high speed spinning state. A flat, level surface is critical for avoiding rotor imbalance during operation. Place centrifuge on a steady platform or table.
- ◆ Adequate space to allow for proper air circulation. Allow at least 30cm clearance around all sides of the centrifuge.

1.4 Installation Steps

- ◆ As soon as you receive the centrifuge, carefully inspect it for shipping damage. Report any damage immediately to the transportation company and file a damage claim, then notify our company.
- ◆ Unpacking package: Removing 8 pcs of M8 wooden screw on top door plank first (refer to Figure 1.4-1) and discharging the top door plank then, other side planks should be integrally unpacked after removing 4 or 6 pcs of M8 wooden screw on side planks. Take off the plastic cover, at last offload the main machine from packing baseboard and place it on the steady platform. Make four rubber cushions stand in balance. (This model usually is heavy, it is best to have three to four persons to moving it) At last, please take care of the package and packing materials to avoiding environment pollution.

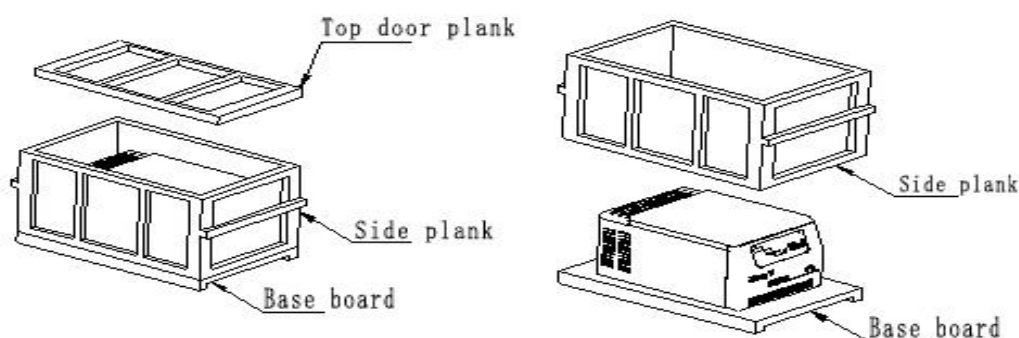

Figure 1.4-1 Unpacking Steps

- ◆ According to the packing list, to check the main machine, accessories, attached tools and files and find whether any parts are missing.



warning: When moving the machine, do not hold the front panel.

- ◆ Power requirements: AC110V \pm 10% 50/60Hz 7A.
- ◆ Make sure that the voltage of power supply must accord with the voltage of centrifuge (Please check the power supply label under the power socket on the back of the centrifuge. This centrifuge is adopted AC with single phase and three wires power 110V 50/60Hz 7A).

Connect the power cord to the electric outlet on centrifuge back first, and then put the plug on the other end into the external mains jack. Press down one side marked “ON” on the switch on the centrifuge right side to power on.

- ◆ Open the door lid: if the centrifuge is powered on, press  key to open the door lid automatically. If the power is off, open the lid by Emergency way (Poke into the Emergency unlock hole on the front panel by using the inner hexagon spanner which along with the centrifuge Tools, aim at the Inner six angle Lock hole of the centrifuge, clockwise rotate to open the Lid). Check the chamber and take out of other materials except for the rotor. Clean up the chamber.

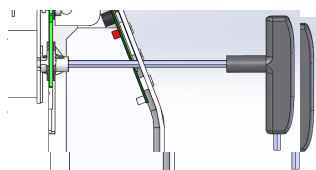

- ◆ Rotor Inspection

Take out of the rotor from the package. Carefully inspect whether the rotor is damaged, deformed or with crack and corrosive spot. If it is, please stop using the rotor immediately and contact the supplier.

- ⚠ Attention : It is forbidden to use the rotor over service life or not designed by our company.
- ⚠ Attention: It is forbidden to use the rotor and accessories with cracks, corrosion spot.
- ⚠ Attention: During operation the cone of the rotor must mate with the cone of the motor shaft properly.

- ◆ Rotor Installation

- (1). Take down the clamping screw components from the motor shaft.
- (2). Clean up the internal hole of the rotor yoke and the motor shaft.
- (3). Angle rotor: Hold the bottom of the rotor with both hands. Place the rotor vertically on the motor drive shaft. Hold the rotor with your left hand, and then insert the T-shaped Allen wrench into the clamping screw components on the rotor shaft with your right hand and screw tightly on clockwise until the cone surface of the rotor is in close contact with the cone surface of the drive shaft. See Figure 1.4-2

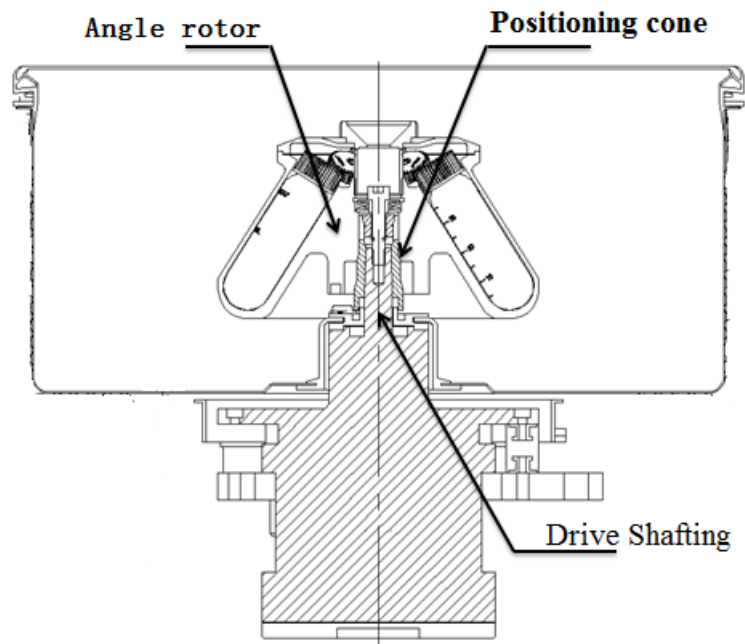

Figure 1.4-2 Angle Rotor installation

Swing rotor: Hold the symmetry axis of the swing rotor with both hands, and place the rotor vertically on the motor drive shaft. Hold the swing rotor with your left hand, and then rotate and tighten it clockwise with a T-shaped Allen wrench with your right hand. At the same time, please place the buckets at the position marked with the same number as the rotor yoke according to the number on the buckets, and the numbered side faces the chamber wall. And check whether the bucket is hung firmly and whether the rotation is flexible. See Figure 1.4-3

⚠ Warning: It is forbidden to install the swing rotor reversely. The conical surface on the rotor must closely match the conical surface on the drive shaft.

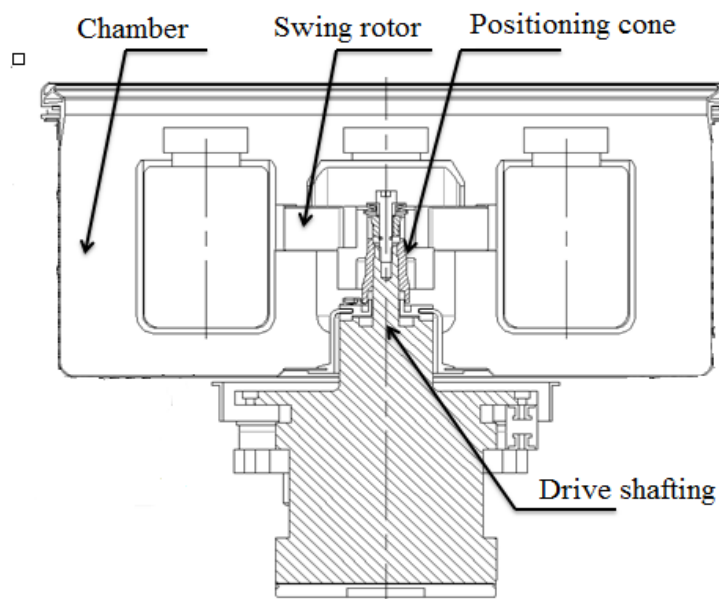
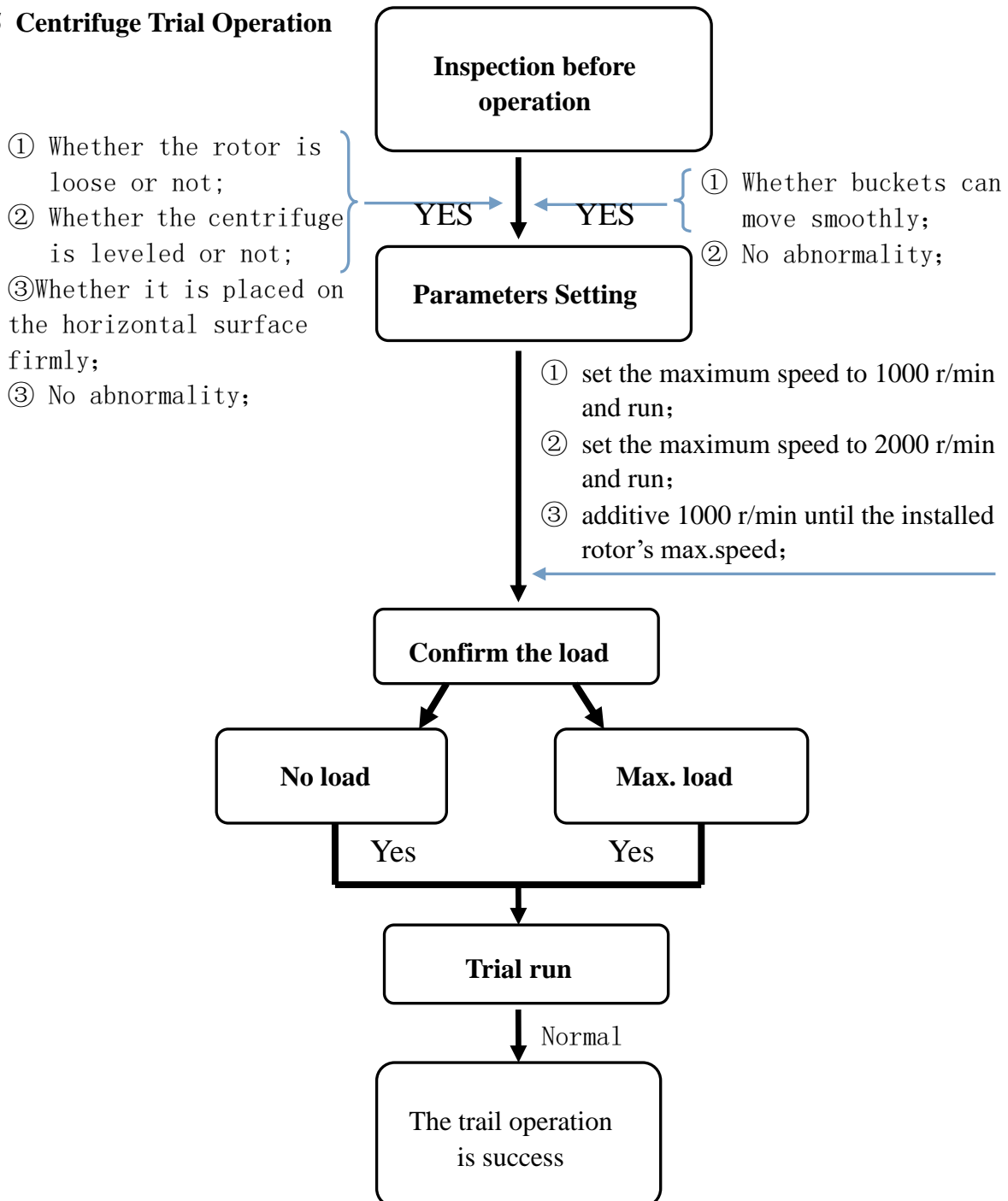

Figure 1.4-3 Swing Rotor installation

◆ Rotor Disassembly

First, gently hold the rotor with one hand to prevent it from shaking, and rotate the T-shaped Allen wrench counterclockwise with the other hand to make the conical surface of the rotor body separate from the conical surface of the drive shaft. Then, for the angle rotor holds the bottom of the rotor with both hands, and for the swing rotor holds both sides of the rotor symmetry axis with both hands to move the rotor vertically and stably away from the motor drive shaft.

1.5 Centrifuge Trial Operation



Chapter 2 Operating Instructions

2.1 Naming Rule

CLT55 is tabletop low speed large capacity centrifuge driven by AC frequency-conversion motor, naming rule as shown in the figure 2.1

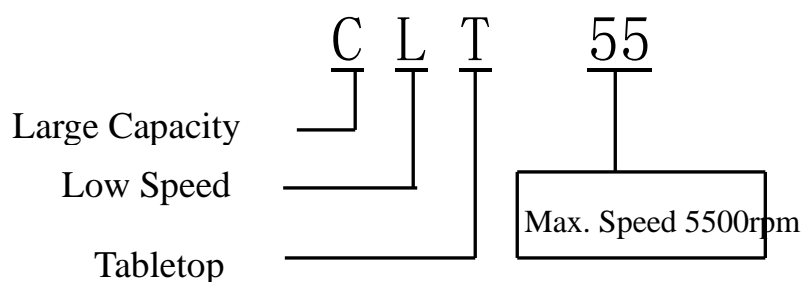

Figure 2.1 Naming Rule

2.2 Main Technical Parameters

Model Name	CLT55
Max Speed	5500r/min
Max RCF	5952×g
Max Capacity	4×750ml
Motor	AC frequency motor
Speed Accuracy	±10r/min
Time Setting Range	1s~99min 59s or 1min~99h59min /HOLD
Power Supply(Single, 3 phase)	AC 110V ± 10% 50/60Hz 7A
Noise	< 65dB(A)
Dimension(D×L×H)	510×635×398(mm)
Net Weight	55kg

Figure 2.2 CLT55 Main Technical Parameters

2.1 Rotor Option

Available rotors for CLT55 are shown in Form 2.3. According to this form you can confirm the used rotor's max. speed, max. RCF and the available adaptors, brackets, buckets for this rotor.

Rotor No.	Max speed	Max RCF	Rotor Name	Max Capacity
NO.1	5500r/min	5952×g	Angle Rotor	40×15ml
NO.2	4000r/min	3274×g	Swing rotor	4×500ml (round bucket) Adaptor optional
NO.3	4000r/min	3345×g	Swing rotor	4×500ml (square bucket) Adaptor optional
NO.4	4000r/min	3310×g	Swing rotor	4×500ml (falcon bucket) Adaptor optional
NO.5	4000r/min	3327×g	Swing rotor	4×750ml (round bucket) Adaptor optional
NO.6	4000r/min	3500×g	Swing rotor	4×750ml (square bucket) Adaptor optional
NO.7	4000r/min	3148×g	Swing rotor	4×2×96 well (deep plate)

Table2.3 CLT55 Rotor

2.4 The Internal Structure and Parts Name of Main Machine

2.4.1 The Basic Structure of Main machine CLT55

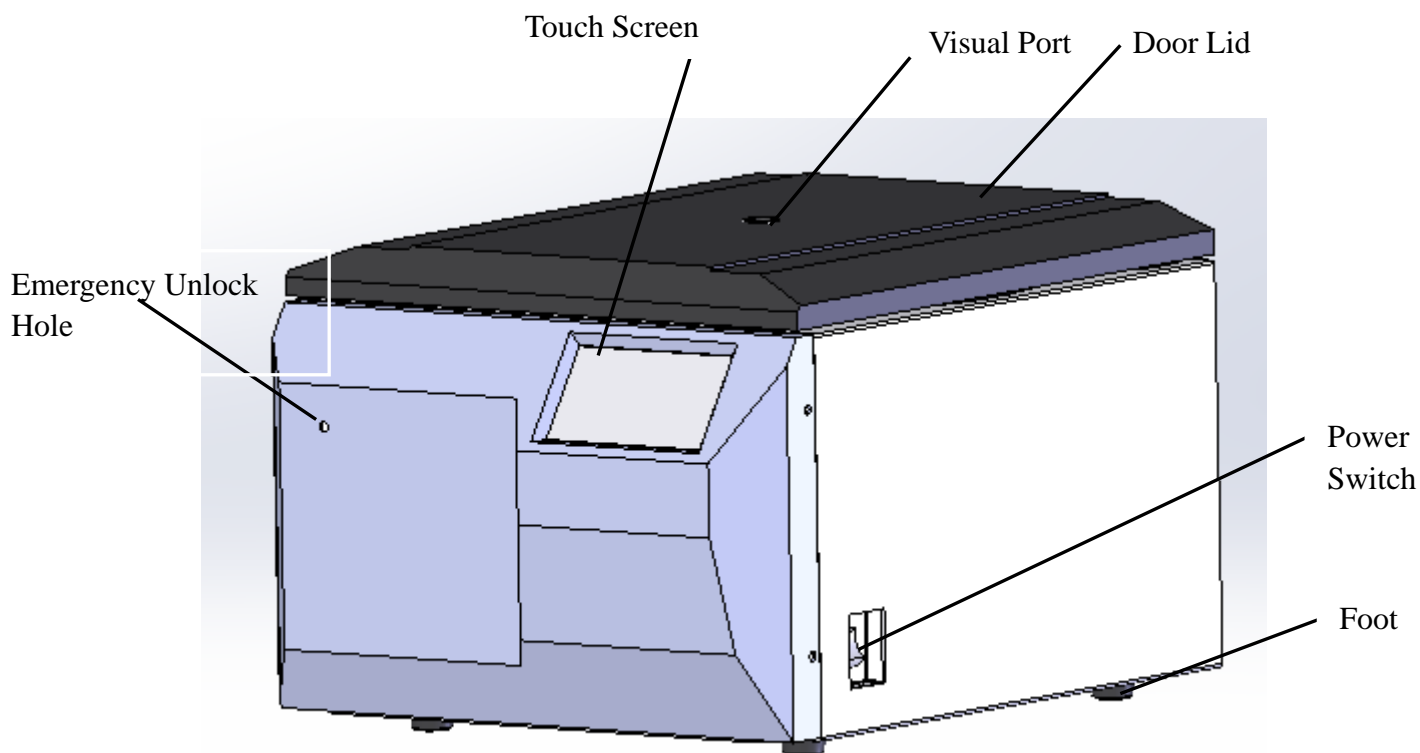

Figure 2.4.1-1 CLT55 Main Machine Appearance

CLT55 is tabletop low speed large capacity centrifuge includes two parts: Main Machine and Accessories. The Main machine is composed of Shell, Lid, Centrifugal chamber, Electric Control system and Display operation part. The Accessory main include Rotors、 Tubes and some operation Tools(Pls reference Packing List).

2.4.2 Driving System

The driving system consists of motor, shock absorber and drive shaft. Driving System please refer to the Figure 2.4.2.

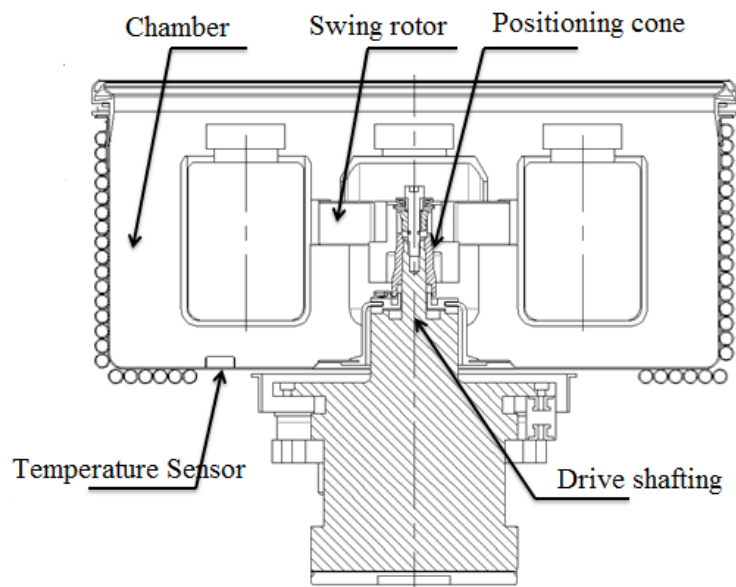



Figure 2.4.2 The driving system

2.5 Operation Steps

1. Check the rotor and tube: You should carefully check the rotor, tube or test bottle before operation.

 It is forbidden to use the cracked and damaged rotor, tube or test bottle. Otherwise it may cause the machine damage or injuries

2. Install Rotor: First align the central hole of the rotor body with the motor shaft. Place the rotor vertically on the motor drive shaft, and then insert the T-shaped Allen wrench into the clamping screw components on the rotor shaft and screw tightly on clockwise until the cone surface of the rotor is in close contact with the cone surface of the drive shaft.

Rotor installation steps:

- (1) Take down the clamping screw components from the motor shaft.
- (2) Clean up the internal hole of the rotor yoke and the motor shaft.
- (3) Put the rotor yoke (cone down) on the motor shaft.
- (4) Screw tightly the clamping screw components on the rotor shaft by T-shape spanner.

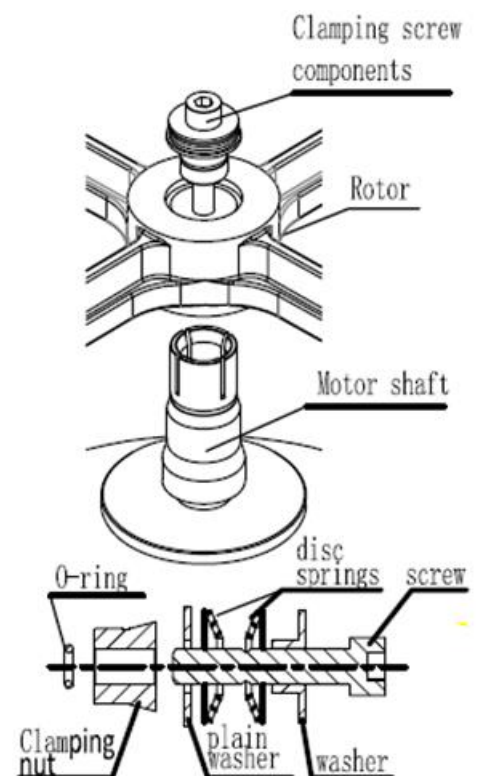

(5) If accidentally disassemble the clamping screw components, please assemble it again according to above figure. Please pay attention to the placing direction of the two disc springs.



Note: Make sure that the rotor is installed properly, otherwise there will be a safety accident.

3. Adding liquid and placing the centrifugal tube:

When adding liquid to the centrifugal tube, use a balance to weigh the liquid with equal weight. Test sample in the centrifugal tubes should be as consistent as possible, and then symmetrically placed into the rotor; and the two symmetrical tubes in the rotor should be equal weight. Tubes must be placed symmetrically, otherwise vibration and noise may occur due to unbalance.

4. Close the door lid: Put the Lid down to the end, then you can hear the closing sound of the motor lock when the Lock hook touch the inductive switch, and the Lid will automatic locking when you lift the door lid by hand and it cannot open. If you press the “START” button, then the centrifuge can’t work normally and will display red fault error “the Dorr Lid is not closed” Error information on top of the screen, which means the door lid is not closed properly; Press the Error information display area to eliminate Error, and then press “ OPEN” button to open the door lid and close the Lid again.

5. Set the rotor No., speed, time, ACC/DEC rates etc. according to the operation instructions.

6. Start and Stop a Run:



Warning: Before inspect the chamber and take out of all materials except for the rotor, do not start the centrifuge. Otherwise, the centrifuge may be damage.





Warning: It is forbidden to run the rotor exceed of its max speed, because over-speed may cause instrument damage and even the personal injury.

- a. **Start:** Press  “START” Button to start centrifuge, and the Start Indicator will light.
- b. **Automatically stop:** When time is counted down to “0”, the centrifuge automatically slows down and stops running. When the speed is 0r/min, you can open the door lock via press “OPEN” button.
- c. **Stop by manual:** In the running status (the working time isn’t counted down to “0”), press



Button to slow down and stop running, and the [STOP] indicator light will light.

When the speed is 0r/min, you can open the door lock via press  “OPEN” button.

- 7. Take out tubes:** When the rotor stops spinning, press the “ OPEN” key to open the door lid(it is forbidden to open the door lid during a run), and then take out tubes.



Attention: When the centrifuge is running, while the Power is off suddenly, so that it will cause the electrical lock can't work, so the Lid can't be open. But if you want to open the Lid, you must wait the rotor stop totally at 0rpm (Wait for 3 minutes after touching the door lid without any vibration felt), and then you can open the Lid by Emergency unlock hole on the front plate of the instrument.

As shown in Fig. 2.5-2, there is an emergency unlock hole on the front plate. Take off the hole plug, and take out the T-shaped Allen key from the equipped tools. Insert the T-shaped Allen Wrench into the unlock hole (which needs to be engaged with the inner hexagon of the locking cam), clamp it down to the position shown in the figure (clamp it to the bottom), turn it clockwise for half a turn, and lift the door cover gently by hand at the same time, and the door lid can be opened.

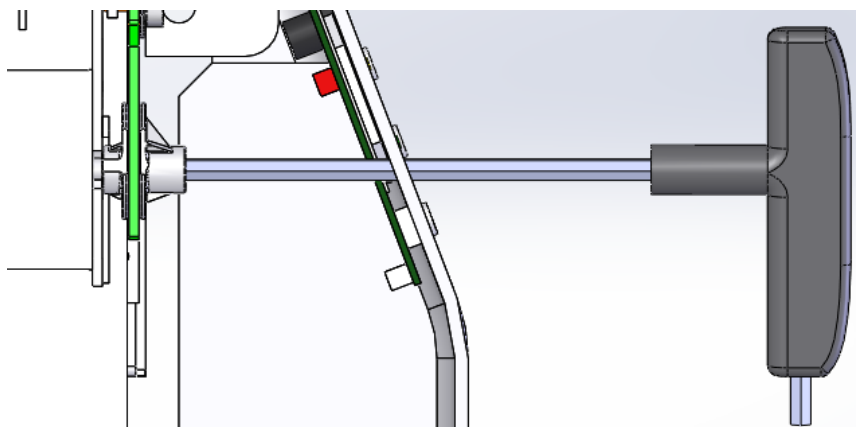

Figure 2.5-2 Schematic diagram of emergency unlocking

- 8. Uninstall the rotor:** Loosen the locking nut with a T-wrench and remove the rotor by moving the rotor upward.
- 9. Turn off the Power:** When the centrifugation work is completed, press the power switch at the back of the centrifuge, and then pull out the plug cord after the power off.



Warning: When the centrifuge is working, do not lift or remove the centrifuge.



Warning: Before the Rotor Stop, do not open the Lid.



Warning: After the last use in every day, the rotor should be taken out.

2.6 Use of Spare Wrench

In some cases, if the rotor is fixed on the drive shaft for a long time (one month or more), the rotor may not be removed smoothly. Please refer to the following methods to remove the rotor. (**only for fixed angle rotor with lid**)

- a) Remove the rotor cover and use a T-wrench to loosen the rotor clamping screw components completely.

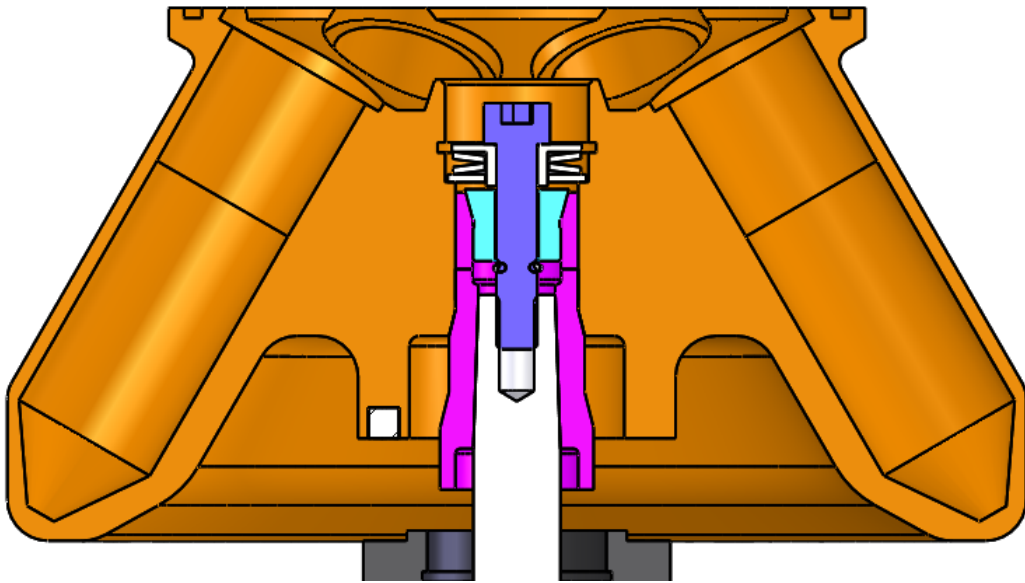

Figure a

- b) Grasp the head of the clamping screw components by hand or other tools and pull upward to separate the screw and its parts from the rotor.

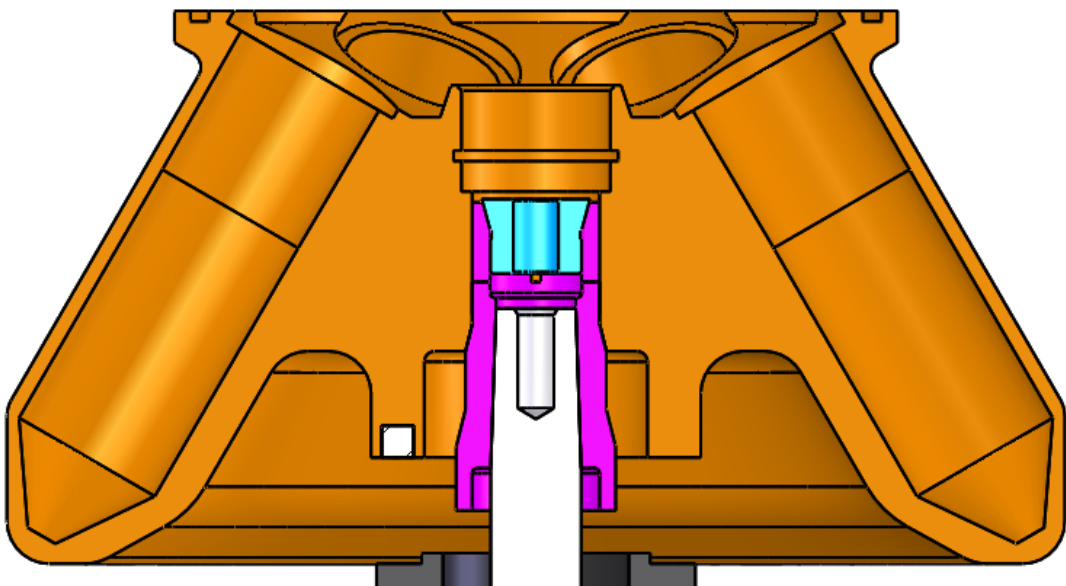

Figure b

- c) Use the attached tool wrench to align the center of the drive seat and screw it in clockwise (a cross screwdriver can be used to pierce the hole on the wrench to increase the torsional force).

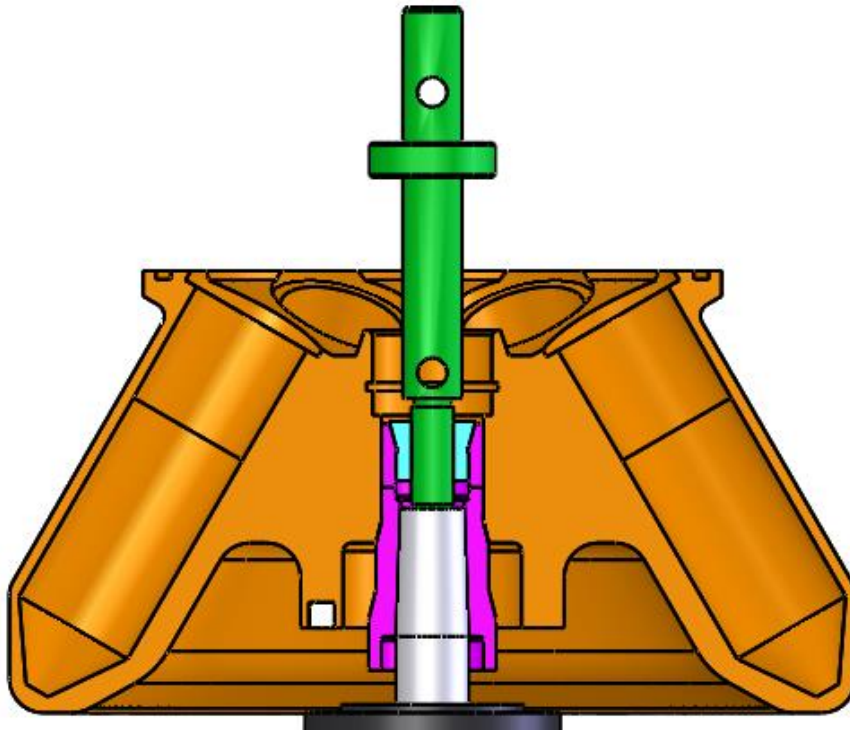

Figure c

- d) Jack up and take down the taper sleeve, and then the rotor can be taken out smoothly. If the rotor still cannot be taken out, refer to step e.

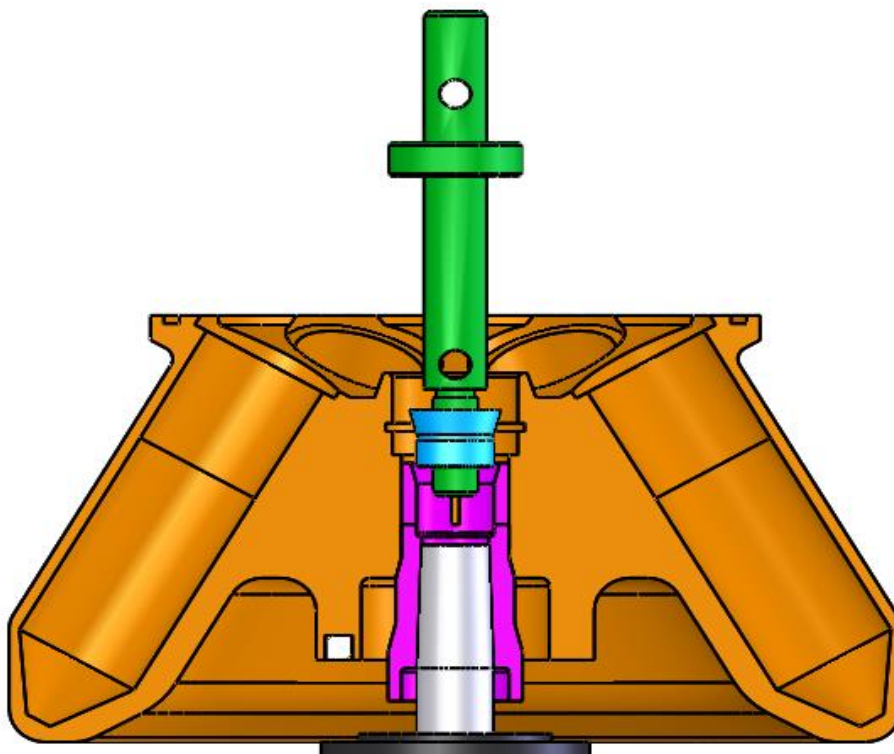

Figure d

- e) Turn the wrench upside down, screw the big head thread into the rotor body, screw it to the end, and use the thread to push out the rotor.

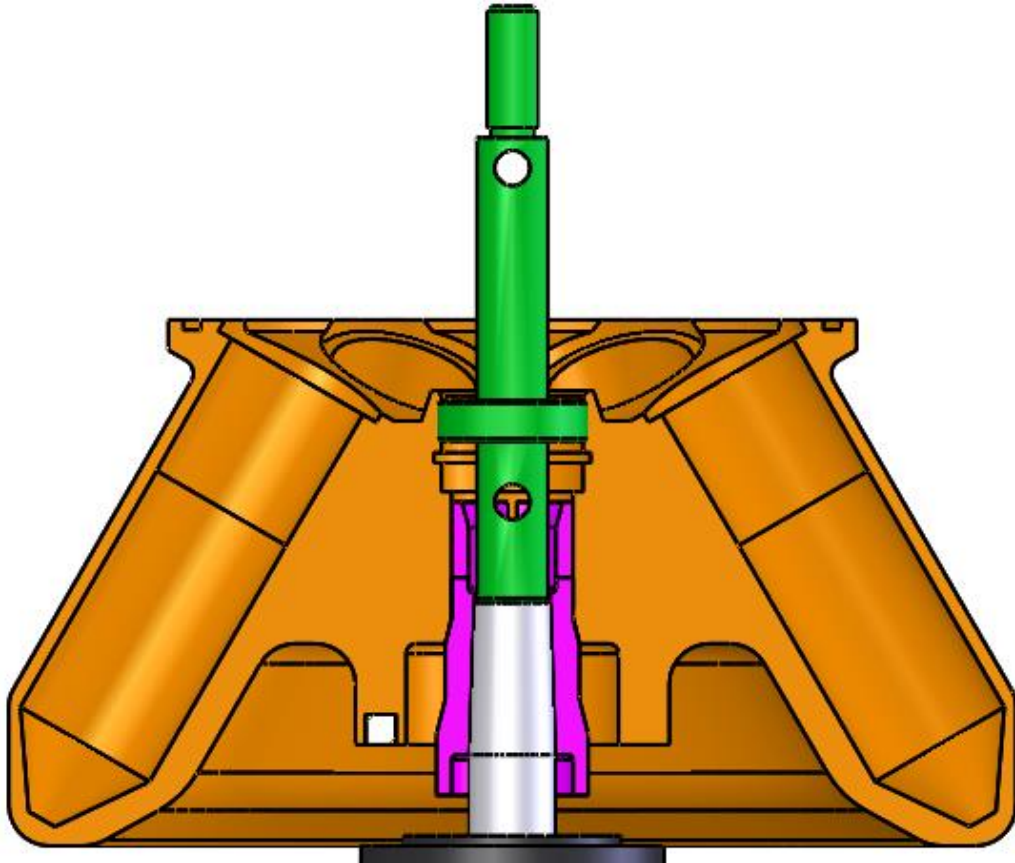
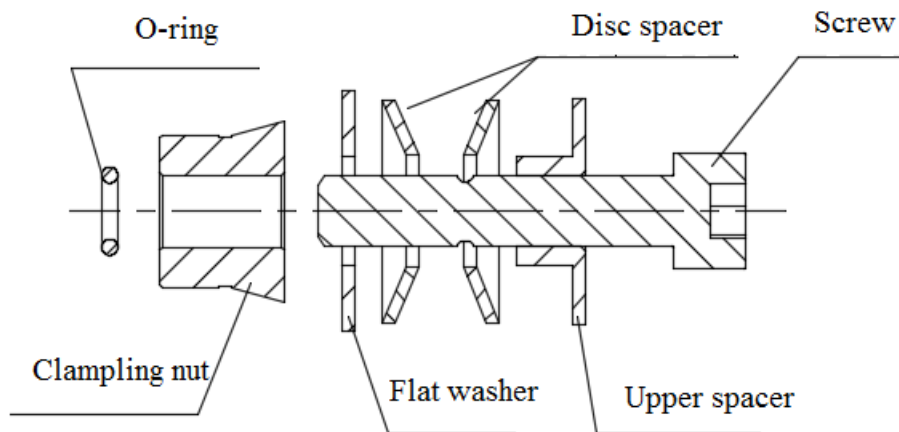

Figure e

- f) Use the spare O-ring and reinstall the clamping screw components according to the figure below. Pay attention to the placing direction of the two disc spacers.



2.7 Control Panel Operating Instructions

2.7.1 The Control panel operating instructions of CLT55

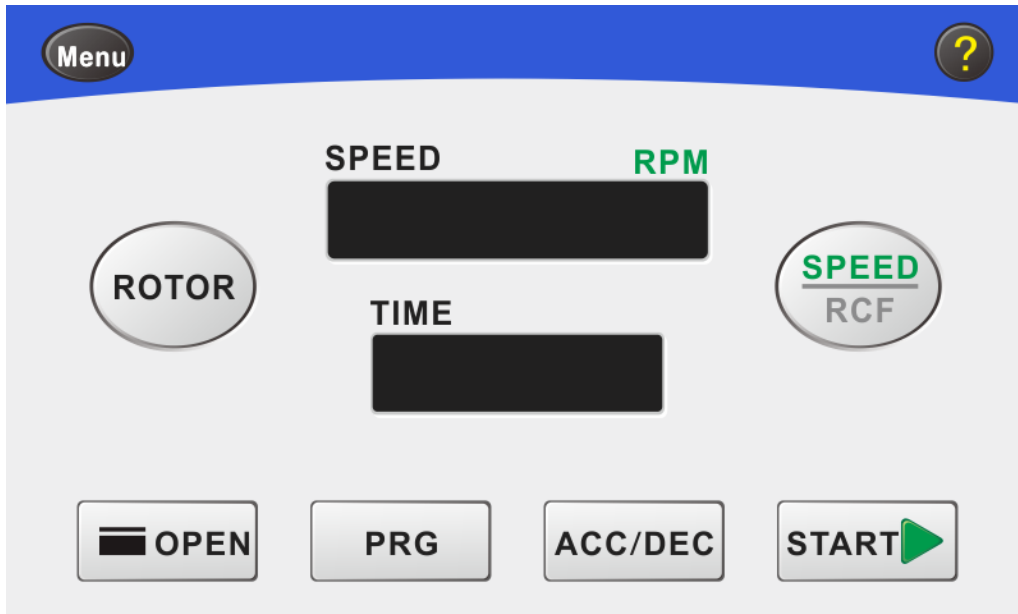



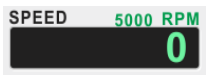
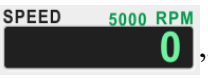









Figure2.5.1 The Main Interface of CLT55 Control Panel



2.7.2 Main interface operation instructions



	<p>“Rotor No. Setting”button</p> <p>Touch“”button , enter the rotor library interface , Touch the corresponding rotor parameters to select the rotor number for this operation, and touch  to confirm. (Rotor number can only be set when the machine is stopped)</p>
---	--



	<p>“Speed-set” button</p> <p>Touch“”button to enter speed-set interface, touch[0~9]button to enter max. speed for the current job, and touch  for confirmation. (Refer to 2.3 section of rotors available for max.speed,)</p>
---	--



	<p>“Time- set” button</p>
	<p>Touch “” button to enter time-set interface, touch [0~9] button to enter time of your current operation, and touch  button for confirmation.</p>





	<p>“ACC Rates-set” button</p>
	<p>Touch “” button to enter into the Accel/Decel setting interface and chose the desired ACC/DEC rates [1~Max]for this operation, and press  to confirm.</p>



	<p>“DEC Rates-set” button</p>
	<p>Touch “” button to enter into the Accel/Decel setting interface and chose the desired ACC/DEC rates [0~Max]for this operation, and press  to confirm.</p>

	<p>“Start”Button</p>
	<p>While the centrifuge is powered on but not working(the rotor does not run), Touch “” button to start centrifuge. The centrifuge starts operation until to the set parameter, The startup icon is changed to ”.</p>



	<p>“Stop”Button</p>
	<p>While the centrifuge is in the working state (set-time countdown does not reach zero) , touch “”button to manually stop the operation of the centrifuge. After the complete stop (the speed is zero), Stop Icon is changed to “”。</p>



	<p>“OPEN”button</p>
	<p>After the centrifuge is completely stopped (speed is zero) or the centrifuge is powered on but not working(the rotor does not run), touch “”button, the electronic door interlock acts and the door lid opens automatically.</p>

 	<p>“RCF /Speed switch”button</p>
	<p>In speed mode, touch “”button, interface switch to RCF display mode.</p>
	<p>In mode of RCF, touch “”button, interface switch to speed display mode. In mode of RCF, touch the RCF display area to set RCF, the same as the speed setting.</p>

	<p>“Program” button</p>
	<p>In mode of stop, touch “”button, the interface is switched to the library display interface. Touch the corresponding button to perform program call, program modification, program addition, program deletion etc.</p>

	<p>“Menu/System options”Button</p>
---	---

	 <p>Touch“”button to enter the interface of “Menu”, and the pull-down menu will appear to select the required options, such as operation record(Log), acceleration and deceleration setting, program settings, system settings, use log, and user settings etc.</p>
--	--

	<p>“Help”Button</p>  <p>Touch“”button, touch screen will display help-information of the current interface.</p>
---	--

2. 7. 3 Operation Steps

- ◆ **Check the rotor and tube:** You should carefully check the rotor, tube or test bottle before operation.



It is forbidden to use the cracked and damaged rotor, tube or test bottle. Otherwise it may cause the machine damage or injuries

- ◆ **Install Rotor:** Hold the rotor bottom by both hands and install the rotor on the motor shaft vertically. Put into the clamping screw components into the rotor center. Then hold up the rotor steadily (not shacking) by one hand, and turn the screw clockwise with a T-wrench until the rotor tightens to the rotor shaft, and then tighten the rotor lid at last.

- ◆ **Adding liquid and placing the centrifugal tube:**

Test sample in the centrifugal tubes should be as consistent as possible, and then symmetrically placed into the rotor; and the two symmetrical tubes in the rotor should be equal weight. Tubes must be placed symmetrically, otherwise vibration and noise may occur due to unbalance. When the load is placed, tighten the rotor cover if the rotor is equipped with a cover. Check whether the rotor is installed in place and stable. Swing rotor must be loaded with the same type of centrifuge tubes.

The relevant centrifuge tube has been provided with a suspension in the rotor's built-in position

and is only allowed to be used at the designated position. It is indicated that symmetrical loading is allowed only. The centrifugal tank must be evenly distributed in all the hanging buckets of the swing rotor. As for the allowed ratio, please refer to the "Annex: rotor and accessories". As for the angle rotor, all the space positions must be fully loaded.

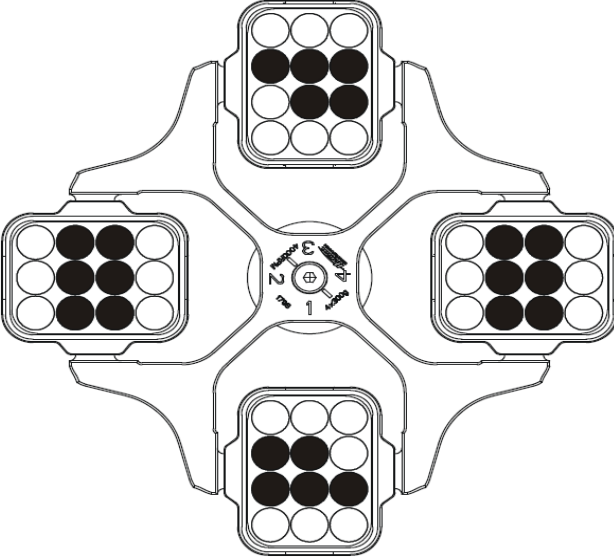
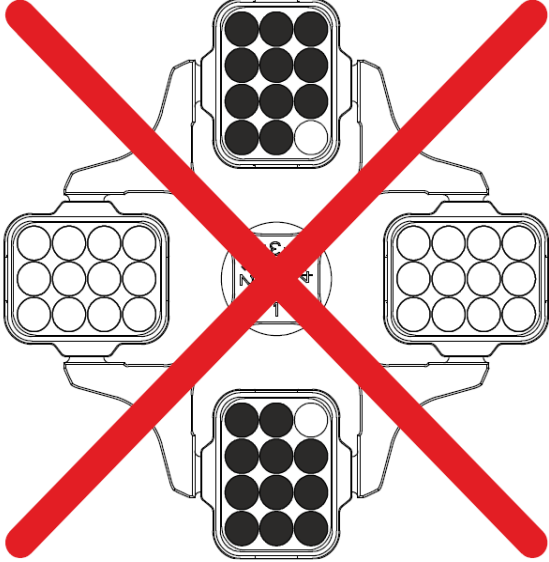
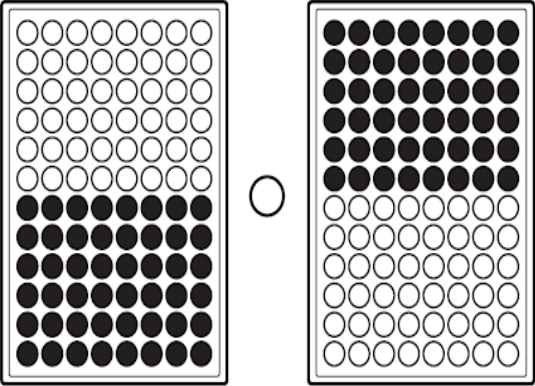
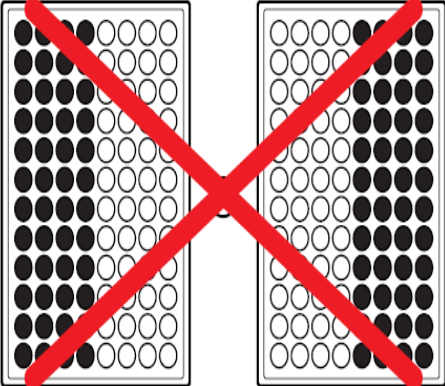
Correct: the tubes are placed symmetrically from the middle to two sides	Wrong: uneven tube placement
	
	

The picture on the right is the wrong demonstration. Error 1: the tubes are placed concentratedly on two buckets, and the load is not balanced which will cause the force generated uneven and cause great imbalance to the motor shaft. Error 2: the tubes I not placed symmetrically with the center of the motor shaft.

Attention:

- **The quantity of Rubber pad on the tube must be same.**
- **In order to avoid unnecessary pollution and ensure the normal operation of the instrument, it is only allowed to load the sample for the tube outside the centrifuge.**
- **It is strictly prohibited to exceed the maximum load specified by the tube manufacturer.**

◆ On some suspension, the maximum load weight, or its maximum load weight, and the maximum load weight of the whole suspension are specified. It should be noted that it is not allowed to exceed the specified weight. For exceptions, please refer to "Maximum Speed Setting Precautions". The max. load weight specification covers the total weight of the adapter, rack, centrifuge tube, and its load.

◆ When the tube is attached with a rubber pad, the number of rubber pad under it must be the same.

The tube to be charged with load is conducted only outside the centrifuge.

Prevent liquid from flowing into the centrifuge chamber during oscillation and charging.

It is not allowed to exceed the max. load specified by the tube supplier.

Please note and confirm that the height of the filler in the centrifuge tubes is equal, so as to minimize the load difference in the tube.

 **Note: Do not exceed the maximum amount of unbalance allowed. The maximum unbalance allowed for the high speed centrifuge is 0.5g.**

◆ Close the door lid: Put the Lid down to the end, then you can hear the closing sound of the motor lock when the Lock hook touch the inductive switch, and the Lid will automatic locking when you lift the door lid by hand and it cannot open. If you press the “START” button, then the centrifuge can’t work normally and will display red fault error “the Dorr Lid is not closed” Error information on top of the screen, which means the door lid is not closed properly; Press the Error information display area to eliminate Error, and then press “ OPEN” button to open the door lid and close the Lid again.

◆ **Turn on the power:** Press the power switch to the position of "ON".

Touch screen display interface, after the power is turned on, after about 3 seconds , the main interface will display the corresponding parameter values; shown as Fig. 2.7.3-1, 2.7.3-2.

Fig.2.7.3-1 Initial interface

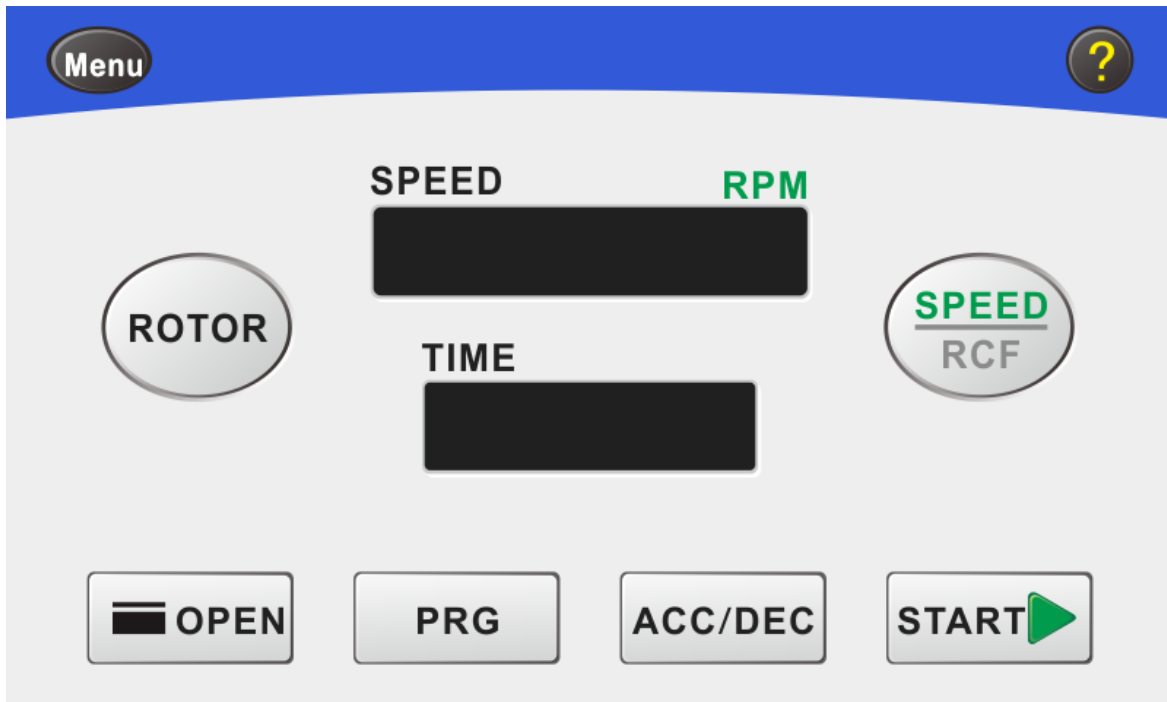



Fig.2.7.3-2 Main Interface

- ◆ **Set operating parameters**
 - ◆ Rotor number, speed, time, acceleration/deceleration time setting of CLT55 centrifuge
 - ◆ In the mode of stop, you can set the program, rotor number, speed, time, and acceleration/deceleration.
 - ◆ In the mode of operation, you can set the speed, time, and acceleration/deceleration.
- a) **Set rotor number:** touch “” button, enter the interface of rotor library, touch relevant rotor parameter to select the rotor number and then touch  for confirmation. (It should be noted that rotor number can only be set when the centrifuge is at the mode of stop. The centrifuge is with the function of rotor identification) .

Rotor	Type	Max.Speed rpm	Max.RCF xg	Max.Capacity ml	Run Time h:h:mm
No.1	Swing	5000	3354	8x10/12X7	

Fig.2.7.3-3 Rotor Library

⚠️ Note: The rotor number must be set in accordance with the rotor number installed. Improperly set the rotor number may cause the rotor to run at an excessive speed and cause an accident.



- b) **How to set speed:** Touch “” button to enter the interface of speed-set, touch [0~9] button to input max.speed of the current operation, then touch  button to save the current settings and jump to temperature setting automatically. If you do not press  button after the time setting, then the setting is invalid. (Refer to 2.3 section for the information of compatible rotors. Confirm that the model of the centrifuge should correspond to the maximum speed supported by the rotor) .



Fig.2.7.3-4 Speed-set



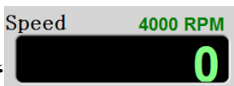







c) **How to set RCF:** Touch  to switch to RCF mode . And then touch  RCF display box on the main interface to enter into the RCF setting interface and set the desired RCF for this operation, and press  to confirm. Speed and RCF can be switched by  button. If you do not press  after setting the RCF value, the setting is invalid. Refer to the figure 2.7.3-5. (Refer to 2.3 section for the information of compatible rotors. Confirm that the model of the centrifuge should correspond to the maximum RCF supported by the rotor).



Fig.2.7.3-5 RCF-set

d) **How to set time:** Touch  button to enter time-set interface, touch [0~9] to input the time for the current operation, temperature scope 00:01~99:59.(When the time is set at 99:99, the centrifuge will enter in HOLD timing mode and run for a long time which won't stop unless press the  button), touch  button to save the current setting and back to the main interface automatically. There is two timing modes(Start the timer:once you press the START button the timer begins; To speed timing: once the speed up to the set-up speed the timer begins), and you can press  to switch the timing mode. There is two timing ranges (“HH:MM”:1min to 99hour59min; “MM:SS”:1s to 99min59s), and you can







press  to switch. If you do not press  after setting the time, the setting is invalid and back to the main interface automatically.



Fig.2.7.3-6 Time-set

e) **How to set ACC:** Touch the menu logo  on the top left corner of the main interface into the system options interface. And then touch “” button to enter the setting interface, touch [1~9] to input the current ACC profiles. At last touch  to save the current parameters. If you do not press  for a long time in the setting interface, the setting is invalid and back to the main interface automatically.

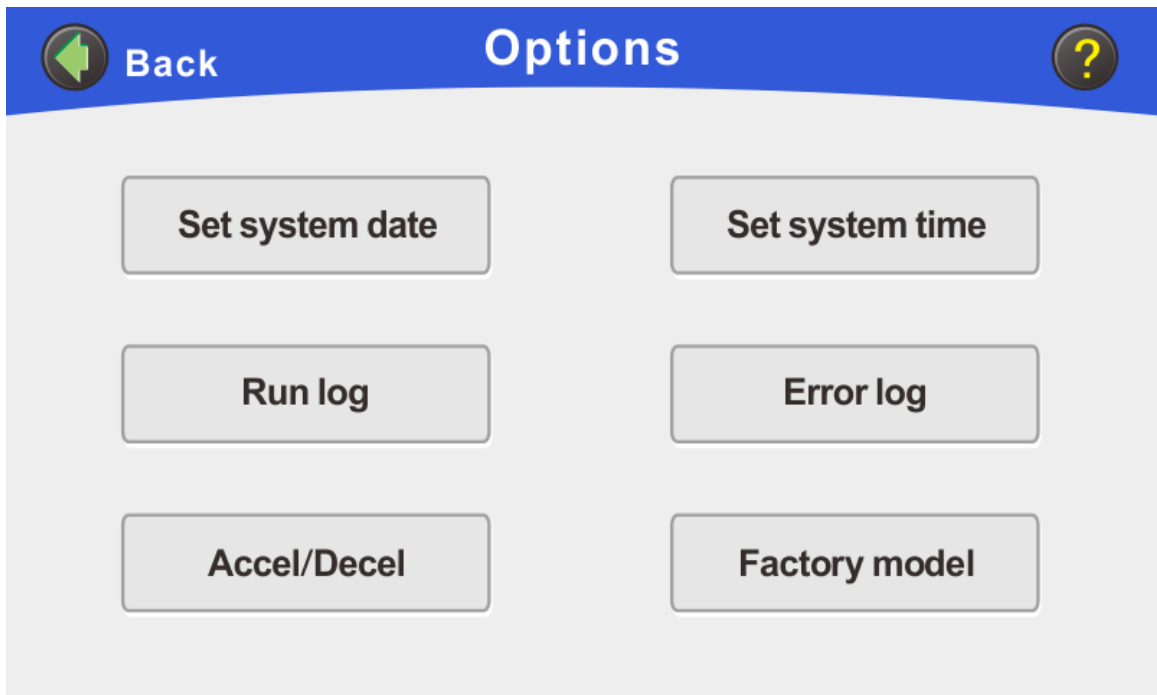





Fig.2.7.3-7 System options interface

f) **How to set DEC:** Touch the menu logo  on the top left corner of the main interface into the system options interface. And then touch “” button to enter the setting interface, touch [1~9] to input the current DEC profiles. At last touch  to save the current parameters. If you do not press  for a long time in the setting interface, the setting is invalid and back to the main interface automatically.

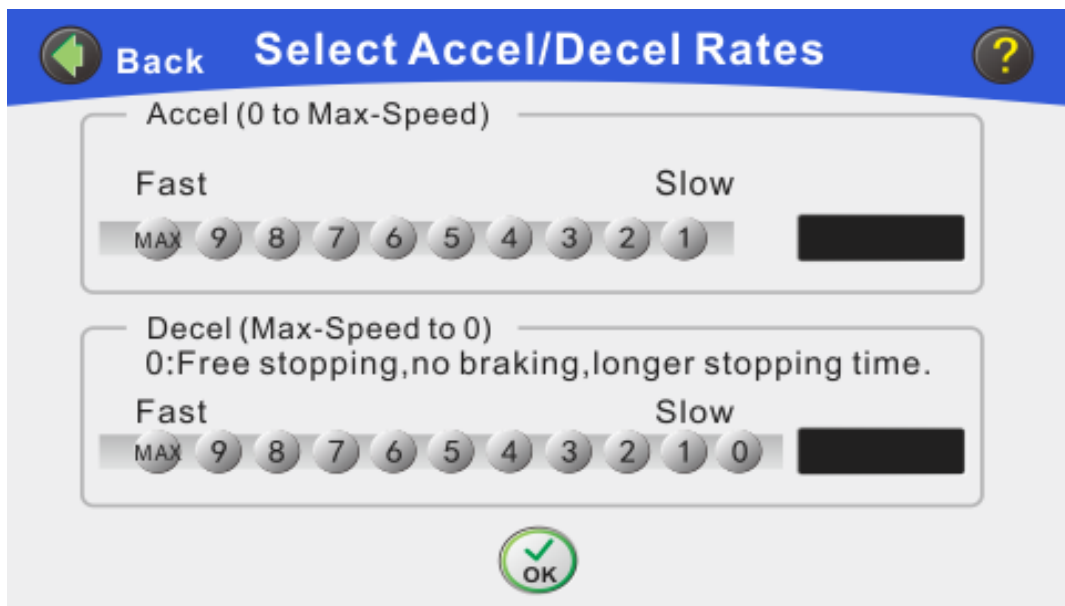

Fig.2.7.3-8 ACC/DEC Profile set

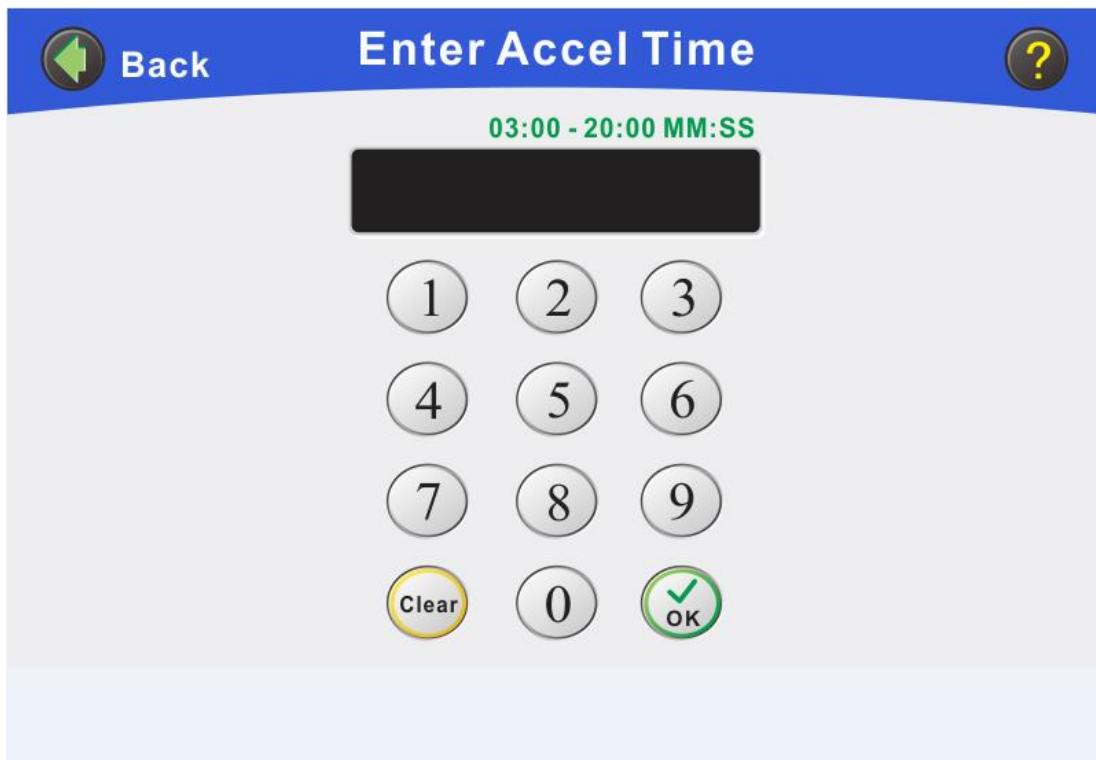





Fig.2.7.3-9 ACC/DEC time setting

◆ **Start and Stop:**

 Do not turn on the centrifuge before checking and removing items from the chamber except for the rotor. Otherwise damage may occur to the centrifuge.

 It is strictly forbidden to run the rotor over the designed max.speed, which may cause damage to the unit or even cause injury to personnel.

 Never lift or move the centrifuge while the centrifuge is running.

 Do not open the door cover while the rotor is rotating.

- 1) **Start:** Touch  button to start the centrifuge.
- 2) **Automatic stop:** When the set-time counts down to zero, the centrifuge slows down and stops running automatically.

When the speed is 0(zero), the door lock can be opened.

- 3) **Manual stop:** If you want to stop the centrifuge under operation (the running time countdown has not reached zero), touch the button  and the centrifuge will decelerate and stop running. When the speed is equal to 0, the door lock can be opened.

- ◆ **Remove the centrifuge tube:** When the rotor is stopped, touch the button“”to open the door cover, press the power switch on the right side of the centrifuge to **OFF** to turn off power, and then remove the centrifuge tube.

- ◆ **Unload the rotor:** Unscrew the screw on the rotor. Hold the rotor body symmetrically with both hands, lift it up vertically and upwards to disengage the rotor body taper from the drive shaft taper. Take out the rotor and place it on a flat tabletop or floor covered with a soft pad.



Note: When loading and unloading the rotor, it must be gentle and smooth to prevent excessive force or improper force to damage the drive shaft.

- ◆ **Turn off the power supply:** after the work is finished, the power supply should be shut down and the power cord plug is pulled out.



Warning: When the centrifuge is working, do not lift or remove the centrifuge.



Warning: Before the Rotor Stop, do not open the Lid.



Warning: After the last use in every day, the rotor should be taken out.

Chapter 3 Service and Maintenance



Note: The power plug must be pulled out before cleaning and maintenance. If the decontamination process other than Xiangyi's suggestion is applied, the user shall consult Xiangyi to confirm whether the method applied will cause damage to the equipment. Indicates a potentially hazardous condition that, if not noticed, could result in personal injury or damage to the machine.

- ◆ It is forbidden to use washing machine to clean centrifuges, rotors and accessories.
- ◆ Only hand wash and liquid disinfection is allowed.
- ◆ Only detergents or disinfectants meeting the following requirements are allowed:
 - The pH value is 5 to 8;
 - The detergents or disinfectants do not contain corrosive alkali, peroxide, chlorinated compound, acid and alkali.
- ◆ In order to avoid rust caused by decontamination and disinfectant, please be sure to comply with the manufacturer's Application Regulations on decontamination and disinfectant.

3.1 Centrifuge (casing, lid and chamber)

1) Surface cleaning and maintenance.

- ◆ Regularly clean the surface of the centrifuge housing and chamber. If necessary, clean cloth can be dipped in soapy water or neutral detergent. This can not only ensure the cleanliness of the parts, but also prevent the parts from rusting due to pollution.
- ◆ Applicable detergent composition:
Soap, anionic surfactant and nonionic surfactant.
- ◆ After using the detergent, wipe the residual detergent with a wet cloth.
- ◆ After cleaning, the surface of the machine must be air dried directly.
- ◆ If there is condensed water in the chamber, it can be dried with absorbent cloth.
- ◆ After each cleaning work, the gasket in the centrifugal chamber must be coated with talcum powder or rubber maintenance glue.

- ◆ Check the chamber is damaged or not every year.



Note: If any damage harmful to safety is found, the centrifuge shall not be used any more. In this case, contact Xiangyi after-sales service department.

- ◆ If infectious substances enter the centrifuge chamber, the centrifuge chamber must be disinfected immediately.
- ◆ Applicable disinfectant composition:
Ethanol, N-propanol, ethyl hexanol, anionic surfactant and preservative.
- ◆ After using the disinfectant, wipe the residual disinfectant with a wet cloth.
- ◆ After disinfection, the surface of sterilized components must be directly air dried.

3.2 Rotor and accessories

1) Cleaning and maintenance

- ◆ In order to prevent corrosion and material deterioration, always use soapy water or other neutral detergent to stain a wet cloth to clean the rotor and accessories. Cleaning once a week is recommended. The occasional dirt should be removed immediately.
- ◆ Applicable detergent composition:
Soap, anionic surfactant and nonionic surfactant.
- ◆ After using the cleaning agent, rinse the residual cleaning agent with clean water (only when the rotor has been taken out, outside the centrifuge), and then wipe it dry with a wet cloth.
- ◆ After cleaning, the rotor and accessories must be air dried directly.
- ◆ The aluminum alloy angle rotor and hanging cup need to be lightly coated with acid free grease (such as Vaseline) after air drying.
- ◆ When applying biosafety systems (refer to chapter "accessories: rotors and accessories" for available biosafety systems), the sealing rings must be inspected and cleaned regularly (once a week). If any crack, crack or strain is found in the sealing ring, it shall be replaced immediately. The sealing ring should be lightly coated with talcum powder or rubber protection fluid after each cleaning.
- ◆ In order to avoid the damp and rusty between the rotor and the motor shaft, the motor should be removed and oil the motor shaft at least once a month.

- ◆ Check the wear and corrosion of rotor and accessory parts regularly every week.
- ◆ Check whether the assembly position of rotor is stable and correct every week.
- ◆ If the centrifuge is not used for a long time, the rotor should be taken out of the centrifugal chamber. Then clean the rotor with neutral detergent in time, dry with clean cloth and store in dry and ventilated place. Apply a little grease to the motor shaft.
- ◆ The rotor shall be installed and removed easily, and the rotor shall be taken out vertically and upward, so as to prevent the rotor falling and damaging the drive shaft.

2) Disinfection

- ◆ If infectious substances adhere to the rotor or accessories, corresponding disinfection work must be carried out.
- ◆ Applicable disinfectant composition:
Ethanol, N-propanol, ethyl hexanol, anionic surfactant and preservative.
- ◆ After using the disinfectant, rinse the residual disinfectant with clean water (only outside the centrifuge), and then wipe it dry with a wet cloth.
- ◆ After disinfection, the rotor and accessories must be dried directly.

3) Autoclave

- ◆ High pressure sterilization/autoclave at 121 ° C (20 minutes) is allowed for the following accessories:

Aluminum alloy / titanium alloy rotor;

Adapter (produced by Xiangyi);

Test bottle / tube (produced by Xiangyi); When high pressure sterilization, the bottle cap must be unscrewed, otherwise the test bottle / tube will be completely deformed;

Biological seal cover;

If you have any questions, please contact Xiangyi after sales service department.



Note: Before pressurized sterilization, the rotor lid must be unscrewed, and the biological seal cover must also be unscrewed.

Pressure sterilization can accelerate the aging process of plastics. It can also cause discoloration of plastics. It is recommended to replace the sealing ring of microbial safety system after pressurized sterilization.

4) Centrifuge Bottle/Tube

- ◆ If the bottle / tube is unsealed or cracked, it is necessary to thoroughly remove the broken slag pieces (if it is a glass bottle / tube, the broken glass pieces) and the centrifugal sample thrown out.
- ◆ If the glass bottle / tube is broken, the rubber pad and plastic cup of the rotor must be replaced.
- ◆ If there are residual infectious substances, they must be disinfected immediately.



Note: Remaining glass fragments can cause other glass breakage!

5) Service life of rotors and accessories

The service life of centrifuge main machine, rotor, adapter, centrifugal bottle, centrifugal tube, etc. is usually related to the operation cycles, operation time, daily maintenance, whether the centrifugal sample is corrosive, etc. Therefore, the wear and corrosion of the drive, rotor and accessory parts must be checked regularly every week. It is forbidden to use the main machine, rotor, adapter and other accessory parts beyond the service life.

Chapter 4 Common trouble and trouble shooting

4.1 Common trouble shooting

During operation, maybe there are following failures, please refer to following methods for easy troubleshooting:

4.1.1 Power on but no display:

- 1) Check whether the input power is accordance with centrifuge rated voltage by multimeter. If it is the power problem, check and troubleshooting.
- 2) Check whether the power cord is connected with the mains jack. If it is loosen and not connected properly, check and troubleshooting.

4.1.2 Loud noise or abnormal vibration:

- 1) Check whether symmetrically placed tubes are with same weight. If the weight does not meet the tolerance requirement, please balancing weight again and make sure symmetrically placed tubes with the same weight.
- 2) Check whether the tube is broken or no. If it is, clear the rotor and place it with the same weight tube.
- 3) Check whether the tubes are symmetrically placed in the rotor. If not, please place them symmetrically.
- 4) Check whether the centrifuge is placed on a steady platform in level and the stress on four foot is in even or not.
- 5) Whether the rotor is bend or not. Whether the ground is stable and there is strong shock around.
- 6) Check whether damping absorber parts are damaged or not. If it is, replace them. (Please conduct under the instruction of professional service engineer.

4.1.3 Poor refrigerating effect(only for refrigerated centrifuge):

- 1) Whether the environment temperature is too high. If it is, please lower the environment temperature by related device. Whether the chamber temperature is higher than the temp setting range of the centrifuge.
- 2) Whether the centrifuge is installed too near the wall.
- 3) Whether the heat sink in condenser is blocked by dust or condensing fan is broken and not run.
- 4) Whether the coolant in refrigerating system is leaked and interfused with air or the refrigerating pipeline is blocked and broken.
- 5) After reparation the quantity of refrigerant pumped in is too much or less, or not meet the requirement.

4.1.4 Centrifuge not work:

- 1) Check whether connecting terminals is connected with circuit board properly and the connection is loose or not. If it is, please fasten the connection wires properly.
- 2) Check whether the input/output voltage is correct with multimeter. If the power supply transformer is broken, please replace it with the same model and specification transformer.
- 3) Check whether the motor is energized with multimeter. If the motor is energized but not rotate, it means the motor is damaged and replace it.
- 4) If the motor can rotate but the rotor does not spin, please check whether the rotor is installed correctly. If no abnormal on the rotor, please contact our service engineer.

4.1.5 Use of emergency switch

- ◆ During the operation of the machine, the power failure and other conditions cause the electronic door lock cannot operate normally, resulting in the door lid can not be opened.
- ◆ Check the emergency switch for door lock before first use.
- ◆ When maintaining the machine, determine the state of the emergency switch for door lock.

4.2 Protection mechanism and Error code analysis

This series of products have five protection mechanism, if encountered fault system it will automatically enter the state of protection, let the centrifuge automatic shutdown, and the touch screen display interface display fault information corresponding; if after troubleshooting, touch fault information display area can erase the fault information.

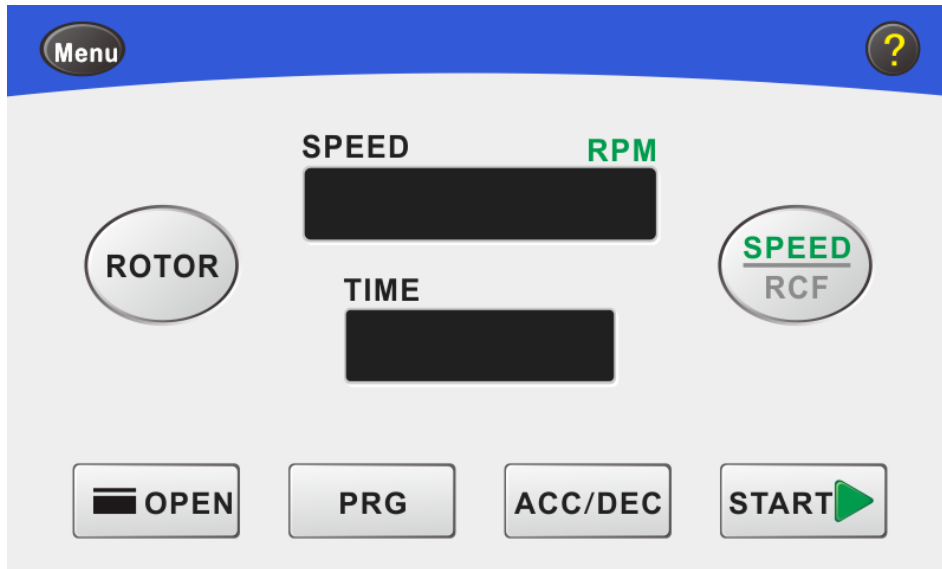

Press Fault display bar on the Upper of the Screen

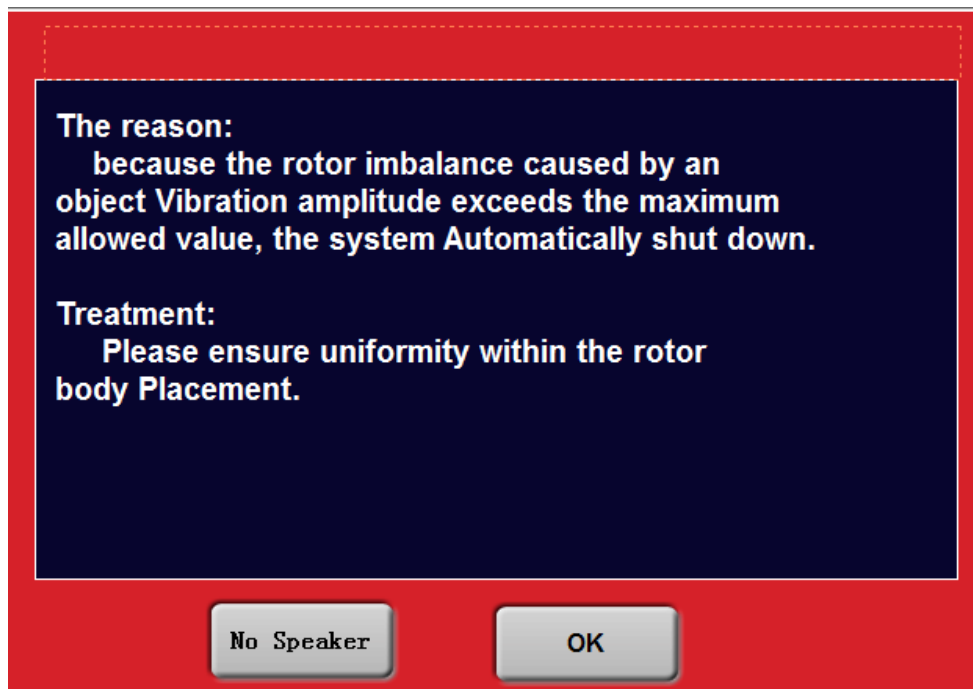

Choose **【OK】** button to erase the fault display.

4.2.1 Door Lid Protection Failure

Diagnostics: As centrifuge belongs to high speed running equipment, if door lid is not closed, system will not be able to start; if we forced to open the door during the process of operation, the system will automatically stop and at the same time in the display window it will show “Lid Error code”. Troubleshooting flows refer to figure 4.2.1-1.

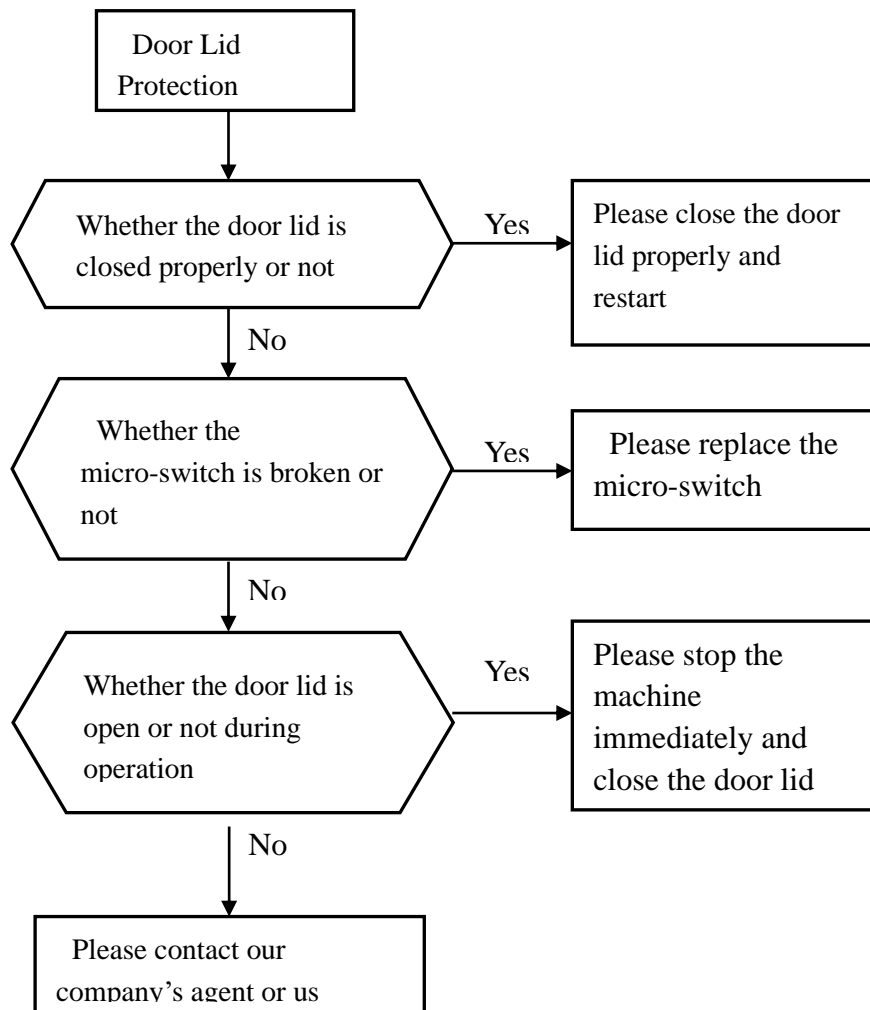

Figure 4.2.1-1 Door Lid Failure Troubleshooting Flows

4.2.2 Overspeed Protection Failure

Diagnostics: When the setting speed exceeds the Max allowable speed of related rotor, the system can't work; When the speed is over the setup speed by 500rpm during centrifuge operation, the system will stop automatically and show "Overspeed error code" on the display window. Troubleshooting flows refer to figure 4.2.2-1

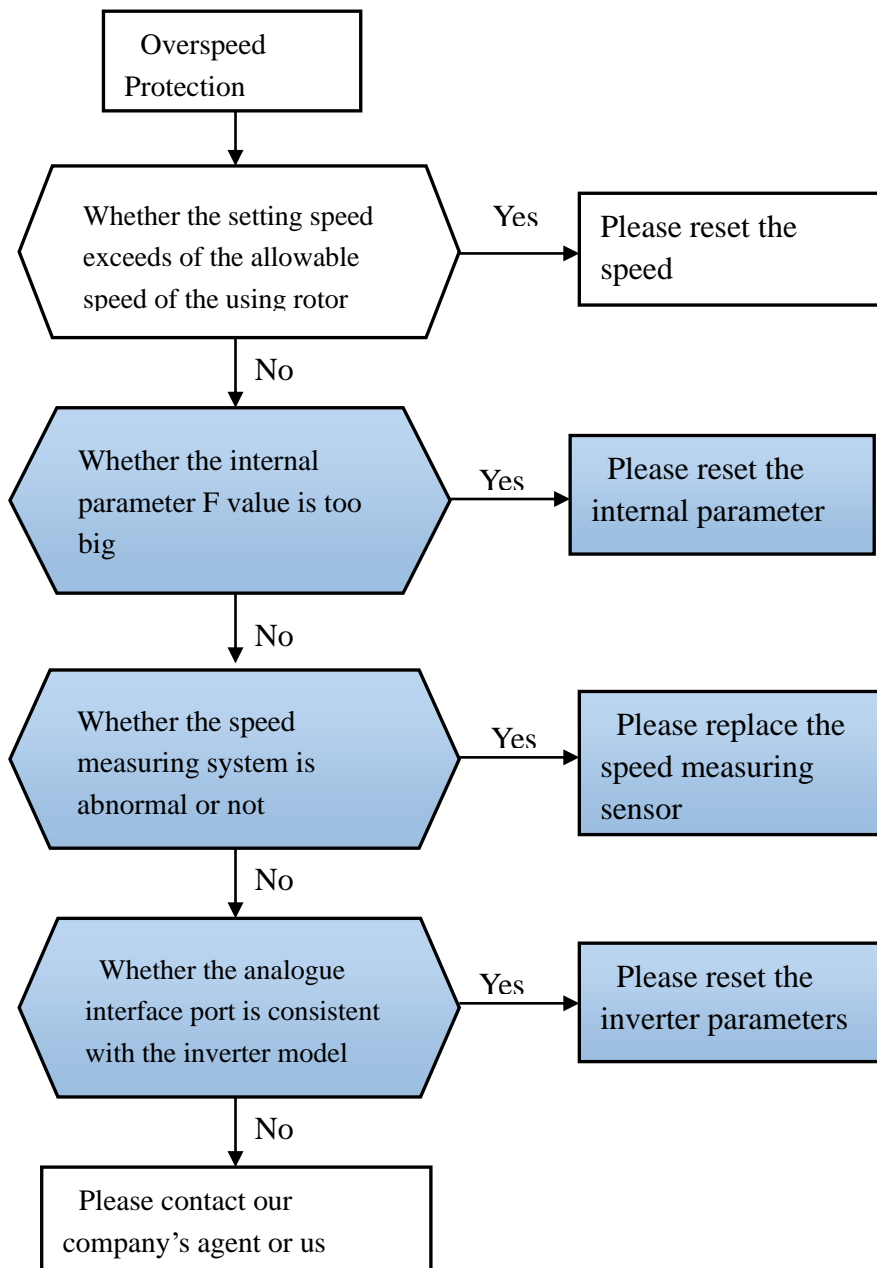

Figure 4.2.2-1 Overspeed Failure Troubleshooting Flows

4.2.3 Speed Measuring Protection Failure

Diagnostics: When speed measuring is failure, the system will stop and show “Speed Measuring error code ” on display window. Troubleshooting flows refer to figure 4.2.3-1.

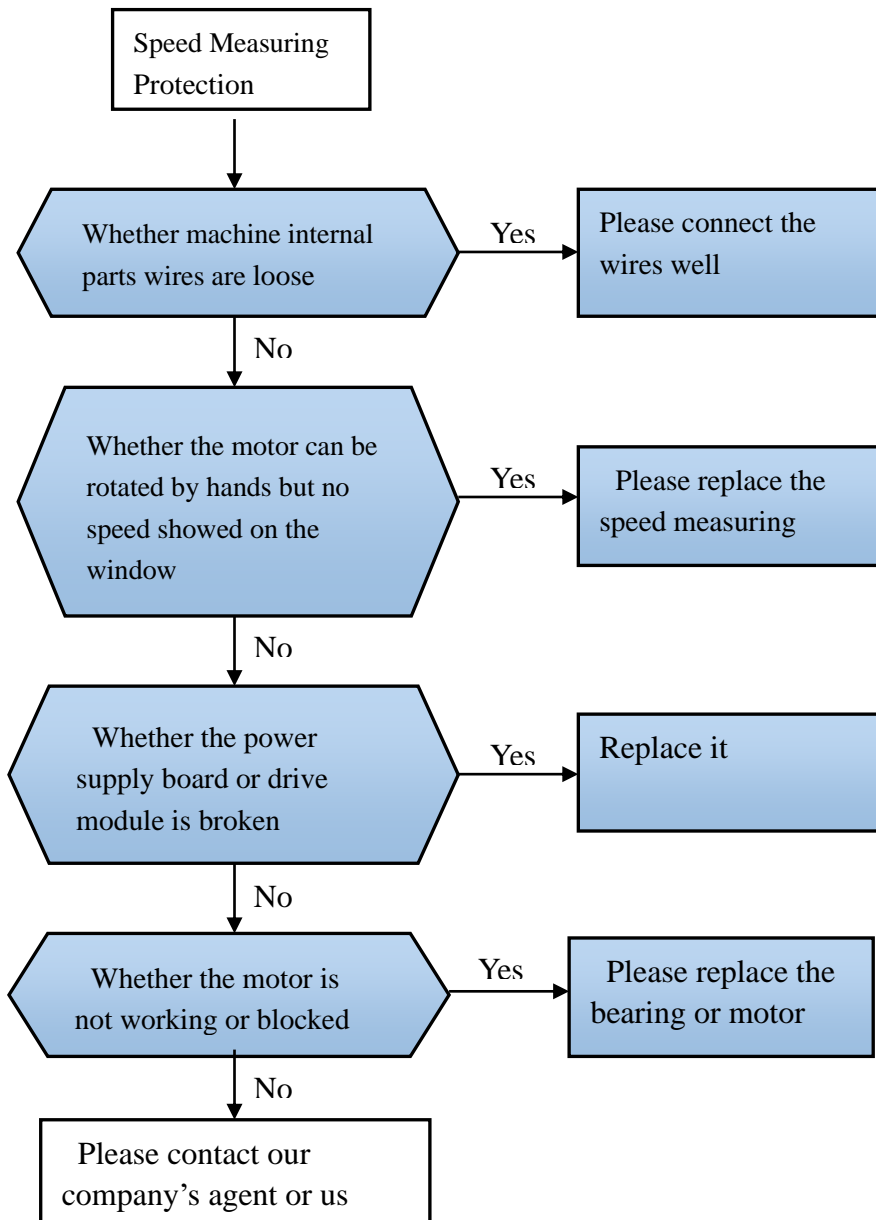

Figure 4.2.3-1 Speed Measuring Failure Troubleshooting Flows

4.2.4 Mal-operation Protection

Diagnostics: If the mal-operation fault code shows before starting centrifuge, the system shall not work; if the mal-operation fault code shows during centrifuge operation, the system shall consider it as invalid setting; if presses START key during stopping situation (Deceleration), the system shall consider it invalid operation and show “Mal-operation error code”. Troubleshooting flows refer to figure 4.2.4-1.

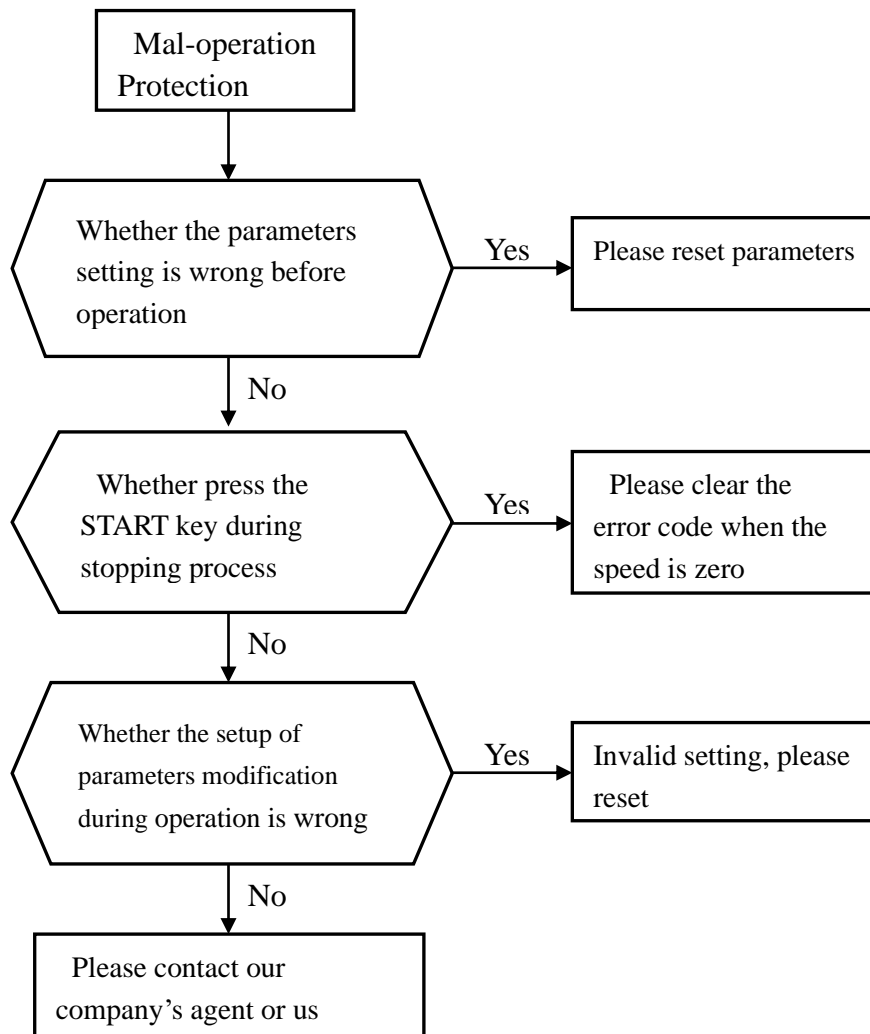

Figure 4.2.4-1 Mal-operation Failure Troubleshooting Flows

4.2.5 Rotor ID protection

Diagnostics: If there is no rotor detected or identification error in operation, the rotor identification fault will be reported. Troubleshooting flows refer to figure 4.2.5-1.

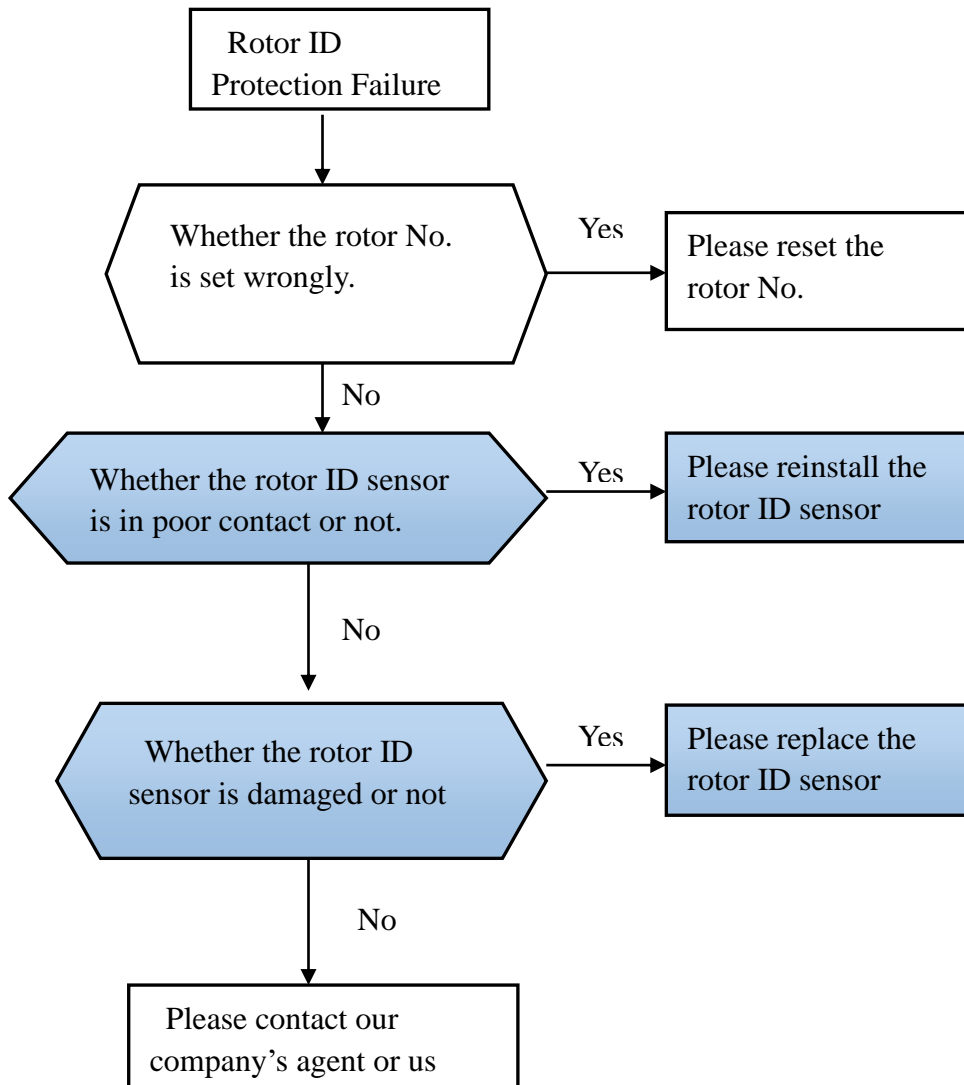

Figure 4.2.5-1 Rotor ID Failure Troubleshooting Flows

4.2.6 Unbalance protection Failure (Only used into the centrifuge which install the Unbalanced detection device)

Diagnostics: When the centrifuge is running, if the unbalance vibration amplitude exceeds a certain value, the system will stop automatically and show “Unbalance error code” .

Troubleshooting flows refer to figure 4.2.6-1

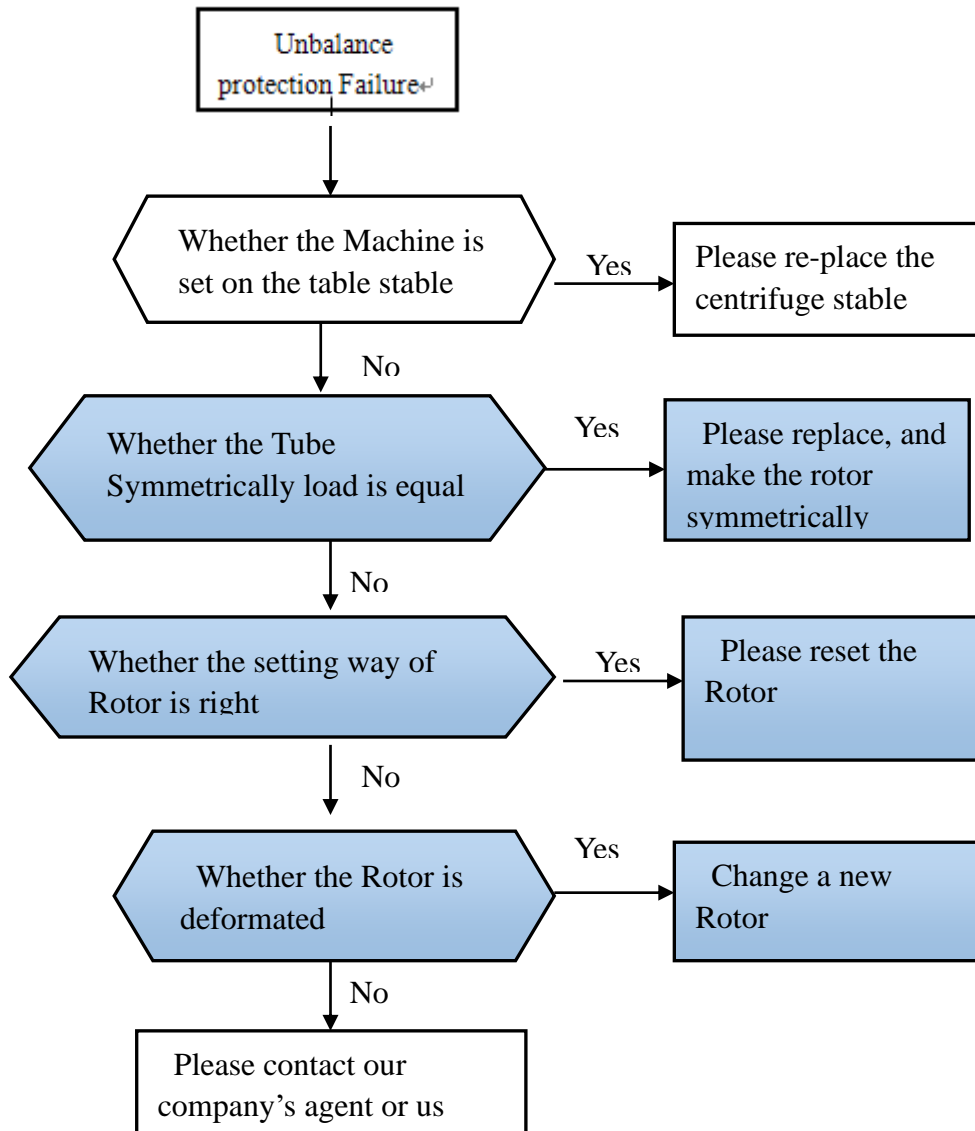

Figure 4.2.6-1 Unbalance Failure Troubleshooting Flows

Note: For the failure with color fill, please ask for service help. You can contact with the local agent where you purchase the centrifuge or contact us directly, and do troubleshooting under professional engineer's instructions.

If there are other failures during operation, which make the centrifuge not working normally, please contact with the service office designated by our company.

Chapter 5 Transportation and Storage

5.1 Transportation

- 1) You should use the wooden case and carton during long-distance transportation. Put centrifuge with dust helmet into the case, and fill with foam or plastic shock absorption materials. It is forbidden to be hit, inverted, and rolled, avoiding big vibration, rough handling, inverted and tilted.
- 2) You can directly move the centrifuge in room for short distance, but avoid big vibration, hitting, inversion and tilting.

5.2 Storage

- 3) If it is leaving unused for long time, the centrifuge should be stored in ventilated, dry and clean room where no corrosive, flammable and explosive matters is.
- 1) If the centrifuge is unused for a long time, please try the best to pack it with the original packages.
- 2) If the centrifuge is unused over one week, you should take out the rotor, and then clean it with neutral cleaning mixture in time and wipe up with cloth.

Version No: V1.0.0

Warranty

Respected customers,

Thank you for purchase of our company's products. To protect your legal rights and avoid your worries, we provide warranty service for one year with the main machines. If it is broken under warranty with inartificial reason, we will supply free maintenance service. The customer needs to pay an amount of money if the product has exceeded the warranty period. We will not supply free maintenance if any following matter is happened:

- Exceed of the warranty period or without the warranty card.
- The trouble is caused by wrong installation, operation and maintenance.
- The trouble is caused by the unauthorized uninstalling and repairing by our company.
- The trouble is caused by using the rotor not equipped with this centrifuge.
- The trouble is caused by war, natural disasters or other irresistible factors.

Packing List

No.	Item	Name	Quantity	Unit	Remark	Check
1	Main Machine	CLT55	1	set		
1	Rotor and Accessory	Swing rotor 4x750ml	1	pc		
2		One customized adapter	1	set		
3						
4						
1	Attached Tool	T-shape spanner	1	pc	Emergency door open and normal rotor installation	
2						
3						
4						
1	Attached File	Packing List	1	copy		
2		Instruction Manual	1	copy		
3		Quality Certificate	1	copy		

Note: Above rotor, accessories and tools in this package can only be used on the centrifuge main machine

Quality Certificate

Product Name: Tabletop Low Speed Large Capacity Centrifuge

Product Model: CLT55

Serial No.:

This production is tested to be qualified for delivery.

Checker:

Date: