

# FURNITURE



**normann**  
COPENHAGEN

# ACE CHAIR UPHOLSTERY STEEL

---

Design: Hans Hornemann, 2016  
Awards: German Design Award 2017, Germany & IF Design Award  
2017, Germany  
Duty Code: 9401710000  
Made in: Lithuania  
Price Groups: 1) Oceanic, Aquarius  
2) Remix, Main Line Flax, Synergy  
3) Canvas, Yoredale  
4) Steelcut Trio, City Velvet  
5) Divina, Divina MD, Divina Melange, Hallingdal, Fiord  
6) Zero, Vidar  
7) Elle, Ultra Læder

<b>Ace Chair Black Steel</b>
Coll: I Size & Weight: H: 80,5 x W: 46 x D: 52,5 x SH: 47 cm - 8,8 kg Packing: Brown Box - H: 49 x L: 57 x D: 22 cm Material: Shell: Veneer, PU Foam, Steel reinforcement, Upholstery, Legs: Powder coated steel, Upholstery: See price groups Production time: 6 weeks
707281 Group 1
707282 Group 2
707283 Group 3
707284 Group 4
707285 Group 5
707286 Group 6
707287 Group 7

# ACE LOUNGE CHAIR WOOD

Design: Hans Hornemann, 2016  
Awards: German Design Award 2017, Germany & IF Design Award  
2017, Germany  
Duty Code: 9401610000  
Made in: Lithuania  
Price Groups: 1) Oceanic, Aquarius  
2) Remix, Main Line Flax, Synergy  
3) Canvas, Yoredale  
4) Steelcut Trio, City Velvet  
5) Divina, Divina MD, Divina Melange, Hallingdal, Fiord  
6) Zero, Vidar  
7) Elle, Ultra Læder

## Ace Lounge Chair Oak

Colli: 1  
Size & Weight: H: 80 x W: 56 x D: 70 x SH: 41 cm - 10,4 kg  
Packing: Brown Box - H: 62 x L: 62 x D: 61 cm - 12,8 kg  
Material: Shell: Veneer, PU Foam, Steel reinforcement, Legs:  
Oak, Upholstery: See price groups  
Production time: 6 weeks

707341  
Group 1

707342  
Group 2

707343  
Group 3

707344  
Group 4

707345  
Group 5

707346  
Group 6

707347  
Group 7

## Ace Lounge Chair Smoked Oak

Colli: 1  
Size & Weight: H: 80 x W: 56 x D: 70 x SH: 41 cm - 10,4 kg  
Packing: Brown Box - H: 62 x L: 62 x D: 61 cm - 12,8 kg  
Material: Shell: Veneer, PU Foam, Steel reinforcement, Legs: Painted and  
Lacquered Oak, Upholstery: See price groups  
Production time: 6 weeks

707351  
Group 1

707352  
Group 2

707353  
Group 3

707354  
Group 4

707355  
Group 5

707356  
Group 6

707357  
Group 7

<b>Ace Lounge Chair Black Oak</b> Colli: 1 Size & Weight: H: 80 x W: 56 x D: 70 x SH: 41 cm - 10,4 kg Packing: Brown Box - H: 62 x L: 62 x D: 61 cm - 12,8 kg Material: Shell: Veneer, PU Foam, Steel reinforcement, Legs: Painted and Lacquered Oak, Upholstery: See price groups Production time: 6 weeks
707361 Group 1
707362 Group 2
707363 Group 3
707364 Group 4
707365 Group 5
707366 Group 6
707367 Group 7

## ACE LOUNGE CHAIR STEEL

Design: Hans Hornemann, 2016  
 Awards: German Design Award 2017, Germany & IF Design Award 2017, Germany  
 Duty Code: 9401710000  
 Made in: Lithuania  
 Price Groups: 1) Oceanic, Aquarius  
 2) Remix, Main Line Flax, Synergy  
 3) Canvas, Yoredale  
 4) Steelcut Trio, City Velvet  
 5) Divina, Divina MD, Divina Melange, Hallingdal, Fiord  
 6) Zero, Vidar  
 7) Elle, Ultra Læder

<b>Ace Lounge Chair Brass</b> Colli: 1 Size & Weight: H: 80 x W: 56 x D: 70 x SH: 41 cm - 10,9 kg Packing: Brown Box - H: 62 x L: 62 x D: 61 cm - 13,3 kg Material: Shell: Veneer, PU Foam, Steel reinforcement, Legs: Brass plated steel, Upholstery: See price groups Production time: 6 weeks
707371 Group 1
707372 Group 2
707373 Group 3
707374 Group 4
707375 Group 5
707376 Group 6
707377 Group 7

<b>Ace Lounge Chair Black Metallic</b> Colli: 1 Size & Weight: H: 80 x W: 56 x D: 70 x SH: 41 cm - 10,9 kg Packing: Brown Box - H: 62 x L: 62 x D: 61 cm - 13,3 kg Material: Shell: Veneer, PU Foam, Steel reinforcement, Legs: Black plated steel, Upholstery: See price groups Production time: 6 weeks
707381 Group 1
707382 Group 2
707383 Group 3
707384 Group 4
707385 Group 5
707386 Group 6
707387 Group 7

## ACE BAR CHAIR 65 CM STEEL

Design: Hans Hornemann, 2019  
 Duty Code: 9401710000  
 Made in: Lithuania  
 Price Groups: 1) Oceanic, Aquarius  
 2) Remix, Main Line Flax, Synergy  
 3) Canvas, Yoredale  
 4) Steelcut Trio, City Velvet  
 5) Divina, Divina MD, Divina Melange, Hallingdal, Fiord  
 6) Zero, Vidar  
 7) Elle, Ultra Læder

<b>Ace Bar Chair 65 cm Black Steel</b> Colli: 1 Size & Weight: H: 98,5 x W: 45 x D: 50,5 x SH: 65 cm - 11,9 kg Packing: Brown Box - H: 100,5 x L: 45 x D: 50,5 cm Material: Shell: Veneer, PU Foam, Steel reinforcement, Upholstery, Legs: Powder coated steel, Upholstery: See price groups Production time: 6 weeks
707261 Group 1
707262 Group 2
707263 Group 3
707264 Group 4
707265 Group 5
707266 Group 6
707267 Group 7

# ACE BAR CHAIR 75 CM STEEL

Design: Hans Hornemann, 2019

Duty Code: 9401710000

Made in: Lithuania

Price Groups: 1) Oceanic, Aquarius

2) Remix, Main Line Flax, Synergy

3) Canvas, Yoredale

4) Steelcut Trio, City Velvet

5) Divina, Divina MD, Divina Melange, Hallingdal, Fiord

6) Zero, Vidar

7) Elle, Ultra Læder

## Ace Bar Chair 75 cm Black Steel

Colli: 1

Size & Weight: H: 108,5 x W: 46 x D: 52,5 x SH: 75 cm - 12,5 kg

Packing: Brown Box - H: 110,5 x L: 48 x D: 54,5 cm

Material: Shell: Veneer, PU Foam, Steel reinforcement, Upholstery, Legs:  
Powder coated steel, Upholstery: See price groups

Production time: 6 weeks

707271

Group 1

707272

Group 2

707273

Group 3

707274

Group 4

707275

Group 5

707276

Group 6

707277

Group 7

# ACE SOFA WOOD

Design: Hans Hornemann, 2016  
Awards: German Design Award 2017, Germany & IF Design Award  
2017, Germany  
Duty Code: 9401610000  
Made in: Lithuania  
Price Groups: 1) Oceanic, Aquarius  
2) Remix, Main Line Flax, Synergy  
3) Canvas, Yoredale  
4) Steelcut Trio, City Velvet  
5) Divina, Divina MD, Divina Melange, Hallingdal, Fiord  
6) Zero, Vidar  
7) Elle, Ultra Læder

## Ace Sofa Oak

Colli: 1  
Size & Weight: H: 81 x W: 145 x D: 75 x SH: 41 cm - 26,4 kg  
Packing: Brown Box - H: 78 x L: 147 x D: 61 cm - 34 kg  
Material: Shell: Veneer, PU Foam, Steel reinforcement, Legs:  
Oak, Upholstery: See price groups  
Production time: 6 weeks

707391  
Group 1

707392  
Group 2

707393  
Group 3

707394  
Group 4

707395  
Group 5

707396  
Group 6

707397  
Group 7

## Ace Sofa Smoked Oak

Colli: 1  
Size & Weight: H: 81 x W: 145 x D: 75 x SH: 41 cm - 26,4 kg  
Packing: Brown Box - H: 78 x L: 147 x D: 61 cm - 34 kg  
Material: Shell: Veneer, PU Foam, Steel reinforcement, Legs: Painted and  
Lacquered Oak, Upholstery: See price groups  
Production time: 6 weeks

707401  
Group 1

707402  
Group 2

707403  
Group 3

707404  
Group 4

707405  
Group 5

707406  
Group 6

707407  
Group 7

<p><b>Ace Sofa Black Oak</b></p> <p>Colli: 1</p> <p>Size &amp; Weight: H: 81 x W: 145 x D: 75 x SH: 41 cm - 26,4 kg</p> <p>Packing: Brown Box - H: 78 x L: 147 x D: 61 cm - 34 kg</p> <p>Material: Shell: Veneer, PU Foam, Steel reinforcement, Legs: Painted and Lacquered Oak, Upholstery: See price groups</p> <p>Production time: 6 weeks</p>
707411 Group 1
707412 Group 2
707413 Group 3
707414 Group 4
707415 Group 5
707416 Group 6
707417 Group 7

## ACE SOFA STEEL

Design: Hans Hornemann, 2016  
Awards: German Design Award 2017, Germany & IF Design Award 2017, Germany  
Duty Code: 9401710000  
Made in: Lithuania  
Price Groups: 1) Oceanic, Aquarius  
2) Remix, Main Line Flax, Synergy  
3) Canvas, Yoredale  
4) Steelcut Trio, City Velvet  
5) Divina, Divina MD, Divina Melange, Hallingdal, Fiord  
6) Zero, Vidar  
7) Elle, Ultra Læder

<p><b>Ace Sofa Brass</b></p> <p>Colli: 1</p> <p>Size &amp; Weight: H: 81 x W: 145 x D: 75 x SH: 41 cm - 27 kg</p> <p>Packing: Brown Box - H: 78 x L: 147 x D: 61 cm - 34 kg</p> <p>Material: Shell: Veneer, PU Foam, Steel reinforcement, Legs: Brass plated steel, Upholstery: See price groups</p> <p>Production time: 6 weeks</p>
707421 Group 1
707422 Group 2
707423 Group 3
707424 Group 4
707425 Group 5
707426 Group 6
707427 Group 7



<b>Ace Sofa Black Metallic</b> Colli: 1 Size & Weight: H: 81 x W: 145 x D: 75 x SH: 41 cm - 27 kg Packing: Brown Box - H: 78 x L: 147 x D: 61 cm - 34 kg Material: Shell: Veneer, PU Foam, Steel reinforcement, Legs: Black plated steel, Upholstery: See price groups Production time: 6 weeks
707431 Group 1
707432 Group 2
707433 Group 3
707434 Group 4
707435 Group 5
707436 Group 6
707437 Group 7

## ACE FOOTSTOOL UPHOLSTERY WOOD

Design: Hans Hornemann, 2016  
 Awards: German Design Award 2017, Germany & IF Design Award 2017, Germany  
 Duty Code: 9401610000  
 Made in: Lithuania  
 Price Groups: 1) Oceanic, Aquarius  
 2) Remix, Main Line Flax, Synergy  
 3) Canvas, Yoredale  
 4) Steelcut Trio, City Velvet  
 5) Divina, Divina MD, Divina Melange, Hallingdal, Fiord  
 6) Zero, Vidar  
 7) Elle, Ultra Læder

<b>Ace Footstool Oak</b> Colli: 1 Size & Weight: H: 39 x W: 45 x D: 45 cm - 5,05 kg Packing: Brown Box - H: 48 x L: 58 x D: 14 cm - 6 kg Material: Shell: Veneer, PU Foam, Steel reinforcement, Legs: Oak, Upholstery: See price groups Production time: 6 weeks
707291 Group 1
707292 Group 2
707293 Group 3
707294 Group 4
707295 Group 5
707296 Group 6
707297 Group 7

<b>Ace Footstool Smoked Oak</b>
Colli: 1 Size & Weight: H: 39 x W: 45 x D: 45 cm - 5,05 kg Packing: Brown Box - H: 48 x L: 58 x D: 14 cm - 6 kg Material: Shell: Veneer, PU Foam, Steel reinforcement, Legs: Painted and Lacquered Oak, Upholstery: See price groups Production time: 6 weeks
707301 Group 1
707302 Group 2
707303 Group 3
707304 Group 4
707305 Group 5
707306 Group 6
707307 Group 7

<b>Ace Footstool Black Oak</b>
Colli: 1 Size & Weight: H: 39 x W: 45 x D: 45 cm - 5,05 kg Packing: Brown Box - H: 48 x L: 58 x D: 14 cm - 6 kg Material: Shell: Veneer, PU Foam, Steel reinforcement, Legs: Painted and Lacquered Oak, Upholstery: See price groups Production time: 6 weeks
707311 Group 1
707312 Group 2
707313 Group 3
707314 Group 4
707315 Group 5
707316 Group 6
707317 Group 7

# ACE FOOTSTOOL UPHOLSTERY STEEL

Design: Hans Hornemann, 2016  
Awards: German Design Award 2017, Germany & IF Design Award  
2017, Germany  
Duty Code: 9401710000  
Made in: Lithuania  
Price Groups: 1) Oceanic, Aquarius  
2) Remix, Main Line Flax, Synergy  
3) Canvas, Yoredale  
4) Steelcut Trio, City Velvet  
5) Divina, Divina MD, Divina Melange, Hallingdal, Fiord  
6) Zero, Vidar  
7) Elle, Ultra Læder

## Ace Footstool Brass

Colli: 1  
Size & Weight: H: 39 x W: 45 x D: 45 cm - 5,5 kg  
Packing: Brown Box - H: 48 x L: 58 x D: 14 cm - 6 kg  
Material: Shell: Veneer, PU Foam, Steel reinforcement, Legs: Brass plated  
steel, Upholstery: See price groups  
Production time: 6 weeks

707321  
Group 1

707322  
Group 2

707323  
Group 3

707324  
Group 4

707325  
Group 5

707326  
Group 6

707327  
Group 7

## Ace Footstool Black Metallic

Colli: 1  
Size & Weight: H: 39 x W: 45 x D: 45 cm - 5,5 kg  
Packing: Brown Box - H: 48 x L: 58 x D: 14 cm - 6 kg  
Material: Shell: Veneer, PU Foam, Steel reinforcement, Legs: Black plated  
steel, Upholstery: See price groups  
Production time: 6 weeks

707331  
Group 1

707332  
Group 2

707333  
Group 3

707334  
Group 4

707335  
Group 5

707336  
Group 6





707337  
Group 7

# ACE GLIDES

Duty Code: 9401999090

Construction: Different types of flooring require different types of glides.  
Ace chair with wood legs is designed without glides.

Maintenance: We recommend to check the glides every 3-6 months. If worn down, please replace.

Ace Lounge Chair, Sofa & Footstool Glides	
	900117 PE for steel / Black / 4pcs
	900118 PE for steel w. felt / Black / 4pcs
Ace Chair & Bar Chair Glides	
	900267 PA for steel / Black / 4pcs
	900268 PA for steel w. felt / Black / 4pcs

# ALLEZ CHAIR PP

Design: Simon Legald, 2021





Duty Code: 9401800000

Made in: Denmark

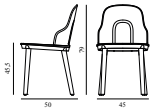
Construction: The Allez chair is a knock-down component-based chair consisting of seven main components of a frame, a seat, a backrest and four legs. The chair is suitable for indoor or outdoor use and all parts are replaceable. The Allez chair is gas-injection molded using pure polypropylene (PP) and weighs only 3.6 kg. The seat is available in polyamide (PA) with a subtle cut-out, molded wicker in PP or with upholstery for indoor or outdoor. The legs are available in PP or lacquered oak. The Allez chair is delivered flat-packed or can be ordered assembled. Assembly manual included. The Allez chair meets European standards Level 2 (EN 16139:2013 and EN 1022:2005).

Maintenance: Clean with a damp cloth.



Allez Chair PP			
Collis:	1		
Size & Weight:	H: 79 x W: 45 x D: 50 x SH: 45,5 cm - 3,6 kg		
Packing:	Flat-packed: Brown Box - H: 50 x L: 44 x D: 15 cm - 3,6 kg - 0,033 m3 / Mounted: Brown Box - H: 64 x L: 47 x D: 91 cm (2 pcs) - 9,3 kg - 0,2737 m3		
Material:	Main body in polypropylene (PP). Seat available in polyamide (PA), molded wicker polypropylene (PP) or indoor or outdoor upholstery. Legs available in polypropylene (PP) or lacquered oak.		
Color:	Black, White, Grey, Warm grey, Park green		
Production time:	2 weeks		
 304040 Black	 304041 White	 304042 Grey	 304043 Warm Grey
			 304044 Park Green

# ALLEZ CHAIR MOLDED WICKER SEAT PP

Design: Simon Legald, 2021  
 Duty Code: 9401800000  
 Made in: Denmark

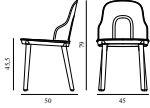

Construction: The Allez chair is a knock-down component-based chair consisting of seven main components of a frame, a seat, a backrest and four legs. The chair is suitable for indoor or outdoor use and all parts are replaceable. The Allez chair is gas-injection molded using pure polypropylene (PP) and weighs only 3.6 kg. The seat is available in polyamide (PA) with a subtle cut-out, molded wicker in PP or with upholstery for indoor or outdoor. The legs are available in PP or lacquered oak. The Allez chair is delivered flat-packed or can be ordered assembled. Assembly manual included. The Allez chair meets European standards Level 2 (EN 16139:2013 and EN 1022:2005).

Maintenance: Clean with a damp cloth.



## Allez Chair Molded wicker seat PP

Colli: 1  
 Size & Weight: H: 79 x W: 45 x D: 50 x SH: 45,5 cm - 3,6 kg  
 Packing: Flat-packed: Brown Box - H: 50 x L: 44 x D: 15 cm - 3,6 kg - 0,033 m3 / Mounted: Brown Box - H: 64 x L: 47 x D: 91 cm (2 pcs) - 9,3 kg - 0,2737 m3  
 Material: Main body in polypropylene (PP). Seat available in polyamide (PA), molded wicker polypropylene (PP) or indoor or outdoor upholstery. Legs available in polypropylene (PP) or lacquered oak.  
 Color: Black, White, Grey, Warm grey, Park green  
 Production time: 2 weeks

 304045 Black	 304046 White	 304047 Grey	 304048 Warm Grey
			 304049 Park Green

# ALLEZ CHAIR UPHOLSTERY PP

Design: Simon Legald, 2021  
 Duty Code: 9401800000  
 Made in: Denmark



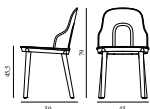

Construction: The Allez chair is a knock-down component-based chair consisting of seven main components of a frame, a seat, a backrest and four legs. The chair is suitable for indoor or outdoor use and all parts are replaceable. The Allez chair is gas-injection molded using pure polypropylene (PP) and weighs only 3.6 kg. The seat is available in polyamide (PA) with a subtle cut-out, molded wicker in PP or with upholstery for indoor or outdoor. The legs are available in PP or lacquered oak. The Allez chair is delivered flat-packed or can be ordered assembled. Assembly manual included. The Allez chair meets European standards Level 2 (EN 16139:2013 and EN 1022:2005).

Maintenance: Clean with a damp cloth.



## Allez Chair Upholstery Main Line Flax PP



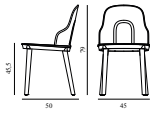

Colli: 1  
 Size & Weight: H: 79 x W: 45 x D: 50 x SH: 45,5 cm - 3,8 kg  
 Packing: Flat-packed: Brown Box - H: 50 x L: 44 x D: 15 cm - 3,6 kg - 0,033 m3 / Mounted: Brown Box - H: 64 x L: 47 x D: 91 cm (2 pcs) - 9,3 kg - 0,2737 m3  
 Material: Main body in polypropylene (PP). Seat available in polyamide (PA), molded wicker polypropylene (PP) or indoor or outdoor upholstery. Legs available in polypropylene (PP) or lacquered oak.  
 Color: Black, Grey, Warm grey, Park green (not available in White)  
 Production time: 2 weeks

 304060 Black	 304061 Grey	 304062 Warm Grey	 304063 Park Green
-----------------------------------------------------------------------------------------------------	----------------------------------------------------------------------------------------------------	---------------------------------------------------------------------------------------------------------	----------------------------------------------------------------------------------------------------------



**Allez Chair Upholstery Canvas PP**



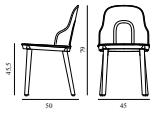

Colli: 1  
 Size & Weight: H: 79 x W: 45 x D: 50 x SH: 45,5 cm - 3,8 kg  
 Packing: Flat-packed: Brown Box - H: 50 x L: 44 x D: 15 cm - 3,6 kg - 0,033 m3 / Mounted: Brown Box - H: 64 x L: 47 x D: 91 cm (2 pcs)- 9,3 kg - 0,2737 m3  
 Material: Main body in polypropylene (PP). Seat available in polyamide (PA), molded wicker polypropylene (PP) or indoor or outdoor upholstery. Legs available in polypropylene (PP) or lacquered oak.  
 Color: Black, White, Grey, Warm grey, Park green  
 Production time: 2 weeks

 304064 Black	 304065 White	 304066 Grey	 304067 Warm Grey
			 304068 Park Green



**Allez Chair Upholstery Ultra Leather PP**

Colli: 1  
 Size & Weight: H: 79 x W: 45 x D: 50 x SH: 45,5 cm - 3,8 kg  
 Packing: Flat-packed: Brown Box - H: 50 x L: 44 x D: 15 cm - 3,6 kg - 0,033 m3 / Mounted: Brown Box - H: 64 x L: 47 x D: 91 cm (2 pcs)- 9,3 kg - 0,2737 m3  
 Material: Main body in polypropylene (PP). Seat available in polyamide (PA), molded wicker polypropylene (PP) or indoor or outdoor upholstery. Legs available in polypropylene (PP) or lacquered oak.  
 Color: Black, White, Grey, Warm grey (not available in Park green)  
 Production time: 2 weeks

 304069 Black	 304070 White	 304071 Grey	 304072 Warm Grey
---------------------------------------------------------------------------------------------------	---------------------------------------------------------------------------------------------------	---------------------------------------------------------------------------------------------------	---------------------------------------------------------------------------------------------------------

## ALLEZ CHAIR OAK

Design: Simon Legald, 2021  
 Duty Code: 9401690000  
 Made in: Denmark



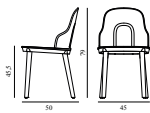

Construction: The Allez chair is a knock-down component-based chair consisting of seven main components of a frame, a seat, a backrest and four legs. The chair is suitable for indoor or outdoor use and all parts are replaceable. The Allez chair is gas-injection molded using pure polypropylene (PP) and weighs only 3.6 kg. The seat is available in polyamide (PA) with a subtle cut-out, molded wicker in PP or with upholstery for indoor or outdoor. The legs are available in PP or lacquered oak. The Allez chair is delivered flat-packed or can be ordered assembled. Assembly manual included. The Allez chair meets European standards Level 2 (EN 16139:2013 and EN 1022:2005).

Maintenance: Clean with a damp cloth.



**Allez Chair Oak**

Colli: 1  
 Size & Weight: H: 79 x W: 45 x D: 50 x SH: 45,5 cm - 3,6 kg  
 Packing: Flat-packed: Brown Box - H: 50 x L: 44 x D: 15 cm - 3,6 kg - 0,033 m3 / Mounted: Brown Box - H: 64 x L: 47 x D: 91 cm (2 pcs)- 9,3 kg - 0,2737 m3  
 Material: Main body in polypropylene (PP). Seat available in polyamide (PA), molded wicker polypropylene (PP) or indoor or outdoor upholstery. Legs available in polypropylene (PP) or lacquered oak.  
 Color: Black, White, Grey, Warm grey, Park green  
 Production time: 2 weeks

 304050 Black	 304051 White	 304052 Grey	 304053 Warm Grey
			 304054 Park Green

# ALLEZ CHAIR MOLDED WICKER SEAT OAK

Design: Simon Legald, 2021  
 Duty Code: 9401690000  
 Made in: Denmark



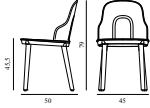

Construction: The Allez chair is a knock-down component-based chair consisting of seven main components of a frame, a seat, a backrest and four legs. The chair is suitable for indoor or outdoor use and all parts are replaceable. The Allez chair is gas-injection molded using pure polypropylene (PP) and weighs only 3.6 kg. The seat is available in polyamide (PA) with a subtle cut-out, molded wicker in PP or with upholstery for indoor or outdoor. The legs are available in PP or lacquered oak. The Allez chair is delivered flat-packed or can be ordered assembled. Assembly manual included. The Allez chair meets European standards Level 2 (EN 16139:2013 and EN 1022:2005).

Maintenance: Clean with a damp cloth.



## Allez Chair Molded Wicker seat Oak

Colli: 1  
 Size & Weight: H: 79 x W: 45 x D: 50 x SH: 45,5 cm - 3,6 kg  
 Packing: Flat-packed: Brown Box - H: 50 x L: 44 x D: 15 cm - 3,6 kg - 0,033 m3 / Mounted: Brown Box - H: 64 x L: 47 x D: 91 cm (2 pcs)- 9,3 kg - 0,2737 m3  
 Material: Main body in polypropylene (PP). Seat available in polyamide (PA), molded wicker polypropylene (PP) or indoor or outdoor upholstery. Legs available in polypropylene (PP) or lacquered oak.  
 Color: Black, White, Grey, Warm grey, Park green  
 Production time: 2 weeks

 304055 Black	 304056 White	 304057 Grey	 304058 Warm Grey
			 304059 Park Green

# ALLEZ CHAIR UPHOLSTERY OAK

Design: Simon Legald, 2020  
 Duty Code: 9401800000  
 Made in: Denmark

Construction: The Allez chair is a knock-down component-based chair consisting of seven main components of a frame, a seat, a backrest and four legs. The chair is suitable for indoor or outdoor use and all parts are replaceable. The Allez chair is gas-injection molded using pure polypropylene (PP) and weighs only 3.6 kg. The seat is available in polyamide (PA) with a subtle cut-out, molded wicker in PP or with upholstery for indoor or outdoor. The legs are available in PP or lacquered oak. The Allez chair is delivered flat-packed or can be ordered assembled. Assembly manual included. The Allez chair meets European standards Level 2 (EN 16139:2013 and EN 1022:2005).

Maintenance: Clean with a damp cloth.

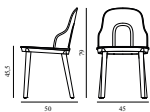

## Allez Chair Upholstery Main Line Flax Oak

Colli: 1  
 Size & Weight: H: 79 x W: 45 x D: 50 x SH: 45,5 cm - 3,8 kg  
 Packing: Flat-packed: Brown Box - H: 50 x L: 44 x D: 15 cm - 3,6 kg - 0,033 m3 / Mounted: Brown Box - H: 64 x L: 47 x D: 91 cm (2 pcs)- 9,3 kg - 0,2737 m3  
 Material: Main body in polypropylene (PP). Seat available in polyamide (PA), molded wicker polypropylene (PP) or indoor or outdoor upholstery. Legs available in polypropylene (PP) or lacquered oak.  
 Color: Black, Grey, Warm grey, Park green (not available in White)  
 Production time: 2 weeks

 304073 Black	 304074 Grey	 304075 Warm Grey	 304076 Park Green
-----------------------------------------------------------------------------------------------------	----------------------------------------------------------------------------------------------------	----------------------------------------------------------------------------------------------------------	------------------------------------------------------------------------------------------------------------

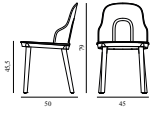

### Allez Chair Upholstery Canvas Oak

Colli: 1  
 Size & Weight: H: 79 x W: 45 x D: 50 x SH: 45,5 cm - 3,8 kg  
 Packing: Flat-packed: Brown Box - H: 50 x L: 44 x D: 15 cm - 3,6 kg - 0,033 m3 / Mounted: Brown Box - H: 64 x L: 47 x D: 91 cm (2 pcs)- 9,3 kg - 0,2737 m3  
 Material: Main body in polypropylene (PP). Seat available in polyamide (PA), molded wicker polypropylene (PP) or indoor or outdoor upholstery. Legs available in polypropylene (PP) or lacquered oak.  
 Color: Black, White, Grey, Warm grey, Park green  
 Production time: 2 weeks

304077 Black	 304078 White	 304079 Grey	 304080 Warm Grey
			 304081 Park Green

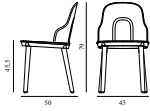

### Allez Chair Upholstery Ultra Leather Oak

Colli: 1  
 Size & Weight: H: 79 x W: 45 x D: 50 x SH: 45,5 cm - 3,8 kg  
 Packing: Flat-packed: Brown Box - H: 50 x L: 44 x D: 15 cm - 3,6 kg - 0,033 m3 / Mounted: Brown Box - H: 64 x L: 47 x D: 91 cm (2 pcs)- 9,3 kg - 0,2737 m3  
 Material: Main body in polypropylene (PP). Seat available in polyamide (PA), molded wicker polypropylene (PP) or indoor or outdoor upholstery. Legs available in polypropylene (PP) or lacquered oak.  
 Color: Black, White, Grey, Warm grey (not available in Park green)  
 Production time: 2 weeks

 304082 Black	 304083 White	 304084 Grey	 304085 Warm Grey
---------------------------------------------------------------------------------------------------	---------------------------------------------------------------------------------------------------	---------------------------------------------------------------------------------------------------	---------------------------------------------------------------------------------------------------------

## ALLEZ TABLE 3L H75 CM

Design: Simon Legald, 2021  
 Duty Code: 9403601000  
 Made in: Denmark

Construction: Allez table consist of a center base in cast iron with three or four legs. The tabletop comes in various sizes and shapes available in marble, veneer or brushed stainless steel. Allez table is suitable for indoor or outdoor use. The table is delivered flat-packed and must be assembled using the included tools. The tabletop is mounted with four screws. The marble tabletops are treated with a surface treatment that penetrates into the material and thereby provides a long-term protection. The surface should not be exposed to acidic foods or beverages, which can leave stains on the surface.

Maintenance: Clean with a damp cloth.

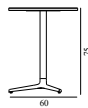

### Allez Table 3L H75 Ø60 cm Oak

Colli: 1  
 Size & Weight: H: 75 x Ø: 60 cm - 13,5 kg  
 Packing: Tabletop: Brown Box - L: 63 x B: 63 x D: 4,5 cm - 5,5 kg - 0,018 m3 - Base: Brown Box - L: 67 x W: 51,5 x H: 18,5 cm - 12,8 kg - 0,064 m3  
 Material: Base: cast iron center base with three legs. Tabletop: oak veneer.  
 Color: Oak, Black oak  
 Production time: 2 weeks

604100  
Oak

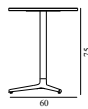

### Allez Table 3L H75 Ø60 cm Marble

Colli: 1  
 Size & Weight: H: 75 x Ø: 60 cm - 22,6 kg  
 Packing: Tabletop: Brown Box - L: 63 x B: 63 x D: 4,5 cm - 0,018 m3 - Base: Brown Box - L: 67 x W: 51,5 x H: 18,5 cm - 0,064 m3  
 Material: Base: cast iron center base with three legs. Tabletop: marble.  
 Color: Black, White, Sand, Coffee  
 Production time: 2 weeks

604101  
Marble



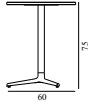

**Allez Table 3L H75 Ø60 cm Steel**  
Colli: 1  
Size & Weight: H: 75 x Ø: 60 cm - 18,6 kg  
Packing: Tabletop: Brown Box - L: 63 x B: 63 x D: 4,5 cm - 0,018 m<sup>3</sup> -  
Base: Brown Box - L: 67 x W: 51,5 x H: 18,5 cm - 0,064 m<sup>3</sup>  
Material: Base: cast iron center base with three legs. Tabletop: brushed stainless steel.  
Color: Steel  
Production time: 2 weeks

604102  
Steel

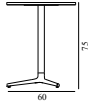

**Allez Table 3L H75 60x60 cm Oak**  
Colli: 1  
Size & Weight: H: 75 x L: 60 x D: 60 cm - 14,5 kg  
Packing: Tabletop: Brown Box - L: 63 x B: 63 x D: 4,5 cm - 6 kg - 0,018 m<sup>3</sup> -  
Base: Brown Box - L: 67 x W: 51,5 x H: 18,5 cm - 12,8 kg - 0,064 m<sup>3</sup>  
Material: Base: cast iron center base with three legs. Tabletop: oak veneer.  
Color: Oak, Black oak  
Production time: 2 weeks

604103  
Oak



**Allez Table 3L H75 60x60 cm Steel**  
Colli: 1  
Size & Weight: H: 75 x L: 60 x D: 60 cm - 21,2 kg  
Packing: Tabletop: Brown Box - L: 63 x B: 63 x D: 4,5 cm - 0,018 m<sup>3</sup> -  
Base: Brown Box - L: 67 x W: 51,5 x H: 18,5 cm - 0,064 m<sup>3</sup>  
Material: Base: cast iron center base with three legs. Tabletop: brushed stainless steel.  
Color: Steel  
Production time: 2 weeks

604104  
Steel

## ALLEZ TABLE 4L H75 CM

**Design:** Simon Legald, 2021  
**Duty Code:** 9403601000  
**Made in:** Denmark  
**Construction:** Allez table consist of a center base in cast iron with three or four legs. The tabletop comes in various sizes and shapes available in marble, veneer or brushed stainless steel. Allez table is suitable for indoor or outdoor use. The table is delivered flat-packed and must be assembled using the included tools. The tabletop is mounted with four screws. The marble tabletops are treated with a surface treatment that penetrates into the material and thereby provides a long-term protection. The surface should not be exposed to acidic foods or beverages, which can leave stains on the surface.  
**Maintenance:** Clean with a damp cloth.



**Allez Table 4L H75 Ø60 cm Oak**  
Colli: 1  
Size & Weight: H: 75 x Ø: 60 cm - 16,8 kg  
Packing: Tabletop: Brown Box - L: 63 x B: 63 x D: 4,5 cm - 5,5 kg - 0,018 m<sup>3</sup> -  
Base: Brown Box - L: 67 x W: 51,5 x H: 18,5 cm - 16 kg - 0,064 m<sup>3</sup>  
Material: Base: cast iron center base with four legs. Tabletop: veneer.  
Color: Oak, Black oak  
Production time: 2 weeks

604105  
Oak



**Allez Table 4L H75 Ø60 cm Marble**  
Colli: 1  
Size & Weight: H: 75 x Ø: 60 cm - 25,9 kg  
Packing: Tabletop: Brown Box - L: 63 x B: 63 x D: 4,5 cm - 0,018 m<sup>3</sup> -  
Base: Brown Box - L: 67 x W: 51,5 x H: 18,5 cm - 0,064 m<sup>3</sup>  
Material: Base: cast iron center base with four legs. Tabletop: marble.  
Color: Black, White, Sand, Coffee  
Production time: 2 weeks

604106  
Marble

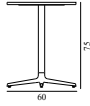

**Allez Table 4L H75 Ø60 cm Steel**  
Colli: 1  
Size & Weight: H: 75 x Ø: 60 cm - 21,9 kg  
Packing: Tabletop: Brown Box - L: 63 x B: 63 x D: 4,5 cm - 0,018 m<sup>3</sup> -  
Base: Brown Box - L: 67 x W: 51,5 x H: 18,5 cm - 0,064 m<sup>3</sup>  
Material: Base: cast iron center base with four legs. Tabletop: brushed stainless steel.  
Color: Steel  
Production time: 2 weeks

604107  
Steel

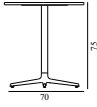

**Allez Table 4L H75 Ø70 cm Oak**  
Colli: 1  
Size & Weight: H: 75 x Ø: 70 cm - 21,3 kg  
Packing: Tabletop: Brown Box - L: 73 x B: 73 x D: 4,5 cm - 8,9 kg - 0,024 m<sup>3</sup> -  
Base: Brown Box - L: 67 x W: 51,5 x H: 18,5 cm - 16 kg - 0,064 m<sup>3</sup>  
Material: Base: cast iron center base with four legs. Tabletop: oak veneer.  
Color: Oak, Black oak  
Production time: 2 weeks

604108  
Oak

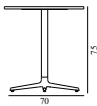

**Allez Table 4L H75 Ø70 cm Marble**  
Colli: 1  
Size & Weight: H: 75 x Ø: 70 cm - 31,5 kg  
Packing: Tabletop: Brown Box - L: 73 x B: 73 x D: 4,5 cm - 0,024 m<sup>3</sup> -  
Base: Brown Box - L: 67 x W: 51,5 x H: 18,5 cm - 0,064 m<sup>3</sup>  
Material: Base: cast iron center base with four legs. Tabletop: marble.  
Color: Black, White, Sand, Coffee  
Production time: 2 weeks

604109  
Marble

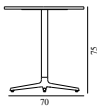

**Allez Table 4L H75 Ø70 cm Steel**  
Colli: 1  
Size & Weight: H: 75 x Ø: 70 cm - 25 kg  
Packing: Tabletop: Brown Box - L: 73 x B: 73 x D: 4,5 cm - 0,024 m<sup>3</sup> -  
Base: Brown Box - L: 67 x W: 51,5 x H: 18,5 cm - 0,064 m<sup>3</sup>  
Material: Base: cast iron center base with four legs. Tabletop: brushed stainless steel.  
Color: Steel  
Production time: 2 weeks

604110  
Steel



**Allez Table 4L H75 60x60 cm Oak**  
Colli: 1  
Size & Weight: H: 75 x L: 60 x D: 60 cm - 17,8 kg  
Packing: Tabletop: Brown Box - L: 63 x B: 63 x D: 4,5 cm - 6 kg - 0,018 m<sup>3</sup> -  
Base: Brown Box - L: 67 x W: 51,5 x H: 18,5 cm - 16 kg - 0,064 m<sup>3</sup>  
Material: Base: cast iron center base with four legs. Tabletop: oak veneer.  
Color: Oak, Black oak  
Production time: 2 weeks

604111  
Oak



**Allez Table 4L H75 60x60 cm Steel**  
Colli: 1  
Size & Weight: H: 75 x L: 60 x D: 60 cm - 24,5 kg  
Packing: Tabletop: Brown Box - L: 63 x B: 63 x D: 4,5 cm - 0,018 m<sup>3</sup> -  
Base: Brown Box - L: 67 x W: 51,5 x H: 18,5 cm - 0,064 m<sup>3</sup>  
Material: Base: cast iron center base with four legs. Tabletop: brushed stainless steel.  
Color: Steel  
Production time: 2 weeks

604112  
Steel

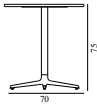

**Allez Table 4L H75 70x70 cm Oak**  
Colli: 1  
Size & Weight: H: 75 x L: 70 x D: 70 cm - 19,9 kg  
Packing: Tabletop: Brown Box - H: 73 x L: 73 x D: 4,5 cm - 7,5 kg - 0,024 m<sup>3</sup> / Base: Brown Box - H: 67 x L: 51,5 x D: 18,5 - 16 kg - 0,063 m<sup>3</sup>  
Material: Base: cast iron center base with four legs. Tabletop: oak veneer.  
Color: Oak, Black oak  
Production time: 2 weeks

604113  
Oak

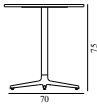

**Allez Table 4L H75 70x70 cm Marble**  
Colli: 1  
Size & Weight: H: 75 x L: 70 x D: 70 cm - 40,6 kg  
Packing: Tabletop: Brown Box - H: 73 x L: 73 x D: 4,5 cm - 0,024 m<sup>3</sup> / Base: Brown Box - H: 67 x L: 51,5 x D: 18,5 - 0,063 m<sup>3</sup>  
Material: Base: cast iron center base with four legs. Tabletop: marble.  
Color: Black, White, Sand, Coffee  
Production time: 2 weeks

604114  
Marble

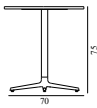

**Allez Table 4L H75 70x70 cm Steel**  
Colli: 1  
Size & Weight: H: 75 x L: 70 x D: 70 cm - 28,7 kg  
Packing: Tabletop: Brown Box - H: 73 x L: 73 x D: 4,5 cm - 0,024 m<sup>3</sup> / Base: Brown Box - H: 67 x L: 51,5 x D: 18,5 - 0,063 m<sup>3</sup>  
Material: Base: cast iron center base with four legs. Tabletop: brushed stainless steel.  
Color: Steel  
Production time: 2 weeks

604115  
Steel

## ALLEZ CHAIR MOUNT FEE

Duty Code: 9401999090

**Allez Chair Mount Fee**

9005

## ALLEZ GLIDES

Duty Code: 9401999090

Construction: Different types of flooring require different types of glides.

Maintenance: We recommend to check the glides every 3-6 months. If worn down, please replace.

**Allez Chair Glides**



404123  
POM /  
PTFE /  
Black /  
4pcs



404124  
POM /  
PTFE w. felt /  
Black /  
4pcs

# ARK ARMCHAIR STEEL

---

Design: Simon Legald, 2022

Duty Code: 9401710000

Made in: Poland

Price Groups: 1) Oceanic, Aquarius

2) Remix, Main Line Flax, Synergy

3) Canvas, Yoredale

4) Steelcut Trio, City Velvet

5) Divina, Divina MD, Divina Melange, Hallingdal, Fiord

6) Zero, Vidar

7) Elle, Ultra Læder

## Ark Armchair Black Steel

Colli: 1

Size & Weight: H: 77 x W: 100 x D: 90 x SH: 43 cm - 33 kg

Packing: Brown Box - H: 820 x L: 960 x D: 1077 cm - 36 kg

Material: Seat: Nozag springs, high-density foam, low-density foam and feather filling, Legs and frame: Powder-coated steel, Upholstery: See price groups

Production time: 6 weeks

707481

Group 1

707482

Group 2

707483

Group 3

707484

Group 4

707485

Group 5

707486

Group 6

707487

Group 7

# ARK MODULAR SOFA STEEL

Design: Simon Legald, 2022  
Duty Code: 9401710000  
Made in: Poland  
Price Groups: 1) Oceanic, Aquarius  
2) Remix, Main Line Flax, Synergy  
3) Canvas, Yoredale  
4) Steelcut Trio, City Velvet  
5) Divina, Divina MD, Divina Melange, Hallingdal, Fiord  
6) Zero, Vidar  
7) Elle, Ultra Læder

## Ark Modular Sofa 100 Left Armrest Black Steel

Colli: 1  
Size & Weight: H: 77 x W: 90 x D: 89 x SH: 43 cm - 26,5 kg  
Packing: Brown Box - H: 820 x L: 960 x D: 1077 cm - 29,5 kg  
Material: Seat: Nozag springs, high-density foam, low-density foam and wadding, Legs and frame: Powder-coated steel, Upholstery: See price groups  
Production time: 6 weeks

707441  
Group 1

707442  
Group 2

707443  
Group 3

707444  
Group 4

707445  
Group 5

707446  
Group 6

707447  
Group 7

## Ark Modular Sofa 110 Center Black Steel

Colli: 1  
Size & Weight: H: 77 x W: 80 x D: 89 x SH: 43 cm - 21 kg  
Packing: Brown Box - H: 820 x L: 960 x D: 1077 cm - 24 kg  
Material: Seat: Nozag springs, high-density foam, low-density foam and feather filling, Legs and frame: Powder-coated steel, Upholstery: See price groups  
Production time: 6 weeks

707451  
Group 1

707452  
Group 2

707453  
Group 3

707454  
Group 4

707455  
Group 5

707456  
Group 6

707457  
Group 7

**Ark Modular Sofa 120 Right Armrest Black Steel**

Colli: 1  
Size & Weight: H: 77 x W: 90 x D: 89 x SH: 43 cm - 26,5 kg  
Packing: Brown Box - H: 820 x L: 960 x D: 1077 cm - 29,5 kg  
Material: Seat: Nozag springs, high-density foam, low-density foam and feather filling, Legs and frame: Powder-coated steel, Upholstery: See price groups  
Production time: 6 weeks

707461  
Group 1

707462  
Group 2

707463  
Group 3

707464  
Group 4

707465  
Group 5

707466  
Group 6

707467  
Group 7

**Ark Modular Sofa 150 Corner Black Steel**

Colli: 1  
Size & Weight: H: 77 x W: 89 x D: 89 x SH: 43 cm - 24,5 kg  
Packing: Brown Box - H: 820 x L: 960 x D: 1077 cm - 27,5 kg  
Material: Seat: Nozag springs, high-density foam, low-density foam and feather filling, Legs and frame: Powder-coated steel, Upholstery: See price groups  
Production time: 6 weeks

707471  
Group 1

707472  
Group 2

707473  
Group 3

707474  
Group 4

707475  
Group 5

707476  
Group 6

707477  
Group 7

# BIT STOOL

Design: Simon Legald, 2021  
 Awards: Best Of Year, Interior Design Magazine, 2021  
 Duty Code: 9403700000  
 Made in: Italy  
 Construction: Bit Stool is made using a rotational molding technique with flexible thermoplastic 100% Low Density Polyethylene Industrial Waste (LDPE).  
 Maintenance: Clean with a damp cloth.



## Bit Stool

Colli: 1  
 Size & Weight: H: 42 x Ø: 36 cm - 4,5 kg  
 Packing: Brown Box - H: 37 x L: 37 x D: 42,5 cm - 5,5 kg  
 M3: 0,0582  
 Material: (LDPE) 100% Low Density Polyethylene Industrial Waste  
 Color: White - Black - White Multi - Black Multi

 603005 White	 603006 Black	 603007 White Multi	 603008 Black Multi
---------------------------------------------------------------------------------------------------	---------------------------------------------------------------------------------------------------	-----------------------------------------------------------------------------------------------------------	-----------------------------------------------------------------------------------------------------------



## Bit Stool Cone

Colli: 1  
 Size & Weight: H: 42 x Ø: 36 cm - 4,5 kg  
 Packing: Brown Box - H: 37 x L: 37 x D: 42,5 cm - 5,5 kg  
 Material: (LDPE) 100% Low Density Polyethylene Industrial Waste  
 Color: Yellow - Blue - Black/White

 605700 Yellow	 605701 Blue	 605702 Black / White
----------------------------------------------------------------------------------------------------	---------------------------------------------------------------------------------------------------	----------------------------------------------------------------------------------------------------------------



## Bit Stool Stack

Colli: 1  
 Size & Weight: H: 42 x Ø: 36 cm - 4,5 kg  
 Packing: Brown Box - H: 37 x L: 37 x D: 42,5 cm - 5,5 kg  
 Material: (LDPE) 100% Low Density Polyethylene Industrial Waste  
 Color: Red - Green - White/White

 605703 Red	 605704 Green	 605705 White / White
---------------------------------------------------------------------------------------------------	-----------------------------------------------------------------------------------------------------	----------------------------------------------------------------------------------------------------------------

# BLOCK

Design: Simon Legald, 2012

Duty Code: 9403208000

Made in: China





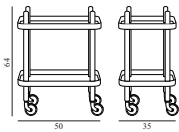

Construction: The Block table and Block shelf comes flat packed. The wheels on the Block table are colored to match the trays and can be turned 360 degrees. A black nylon ring around the wheel adds grip and stability. The table is easy to move around using its handles. The Block shelf consists of three spacious tray shelves held up by a light yet solid wooden frame. The shelving unit is available in two monochrome contrast colors: white and black. Assembly manual included for both table and shelving unit. Load capacity: 10 kg per shelf.

Maintenance: Clean with damp cloth.



## Block Table

Colli: 1  
 Size & Weight: H: 64 x L: 50 x D: 35 cm - 8,8 kg  
 Packing: Brown Box - H: 43 x L: 56 x D: 15 cm - 10 kg  
 M3: 0,0361  
 Material: Powder Coated Steel, Lacquered Ash or Painted and Lacquered Ash

 602195 White / White	 602196 Black / Black	 602200 Light Grey	 602202 White
		 602205 Dark Grey	 602207 Black

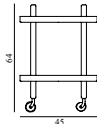

## Block Table Ø45 cm

Colli: 1  
 Size & Weight: H: 64 x Ø: 45 cm - 8,8 kg  
 Packing: Brown Box - H: 43 x L: 45 x D: 15 cm - 10 kg  
 Material: Powder Coated Steel, Lacquered Ash

 602197 White	 602198 Black
-------------------------------------------------------------------------------------------------------	-------------------------------------------------------------------------------------------------------

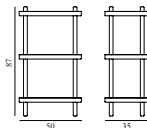

## Block Shelf

Colli: 1  
 Size & Weight: H: 87 x L: 50 x D: 35 cm - 11,8 kg  
 Packing: Brown Box - H: 42 x L: 55 x D: 20 cm - 14,2 kg  
 M3: 0,0462  
 Material: Powder Coated Steel, Painted and Lacquered Ash Veneer

 602193 Black / Black	 602194 White / White
---------------------------------------------------------------------------------------------------------------	---------------------------------------------------------------------------------------------------------------



# CIRCA BARSTOOL 65 CM

Design: Simon Legald, 2021  
 Duty Code: 9401800000  
 Made in: Denmark



Construction: The Circa stool comprises a black powder coated steel frame and a circular oak veneer, black Aluminum or upholstered seat. Circa is delivered assembled.

Maintenance: Clean with damp cloth. Textile upholstery: clean with textile or upholstery cleaner. Leather: clean with damp cloth. Use warm water with soap flakes. Frequent vacuuming with a soft fitting is recommended for both textile and leather to preserve color and appearance.



## Circa Barstool 65 cm Black Steel

Colli: 1  
 Size & Weight: H: 65 x W: 37 cm - 5,4 kg  
 Packing: Brown Box - H: 67 x L: 39 x D: 39 cm - 6,6 kg  
 Material: Frame in black powder coated steel. Seat available in lacquered oak veneer, black lacquered oak veneer or black lacquered aluminum.  
 Production time: 2 weeks

	506080 Oak
	506081 Black Oak
	506083 Black Aluminum

# CIRCA BARSTOOL 65 CM UPHOLSTERY

Design: Simon Legald, 2021  
 Duty Code: 9401800000  
 Made in: Denmark





Construction: The Circa stool comprises a black powder coated steel frame and a circular oak veneer, black Aluminum or upholstered seat. Circa is delivered assembled.

Maintenance: Clean with damp cloth. Textile upholstery: clean with textile or upholstery cleaner. Leather: clean with damp cloth. Use warm water with soap flakes. Frequent vacuuming with a soft fitting is recommended for both textile and leather to preserve color and appearance.



## Circa Barstool 65 cm Upholstery Black Steel

Colli: 1  
 Size & Weight: H: 65 x W: 37 cm - 5,4 kg  
 Packing: Brown Box - H: 67 x L: 39 x D: 39 cm - 6,6 kg  
 Material: Frame in black powder coated steel. Seat available in several types of upholstery, both textile and leather.  
 Production time: 2 weeks

	506086 MLF16 Black
	506087 Ultra Leather Brandy
	506088 Ultra Leather Black
	506137 MLF20 Sand

## CIRCA BARSTOOL 75 CM

Design: Simon Legald, 2021

Duty Code: 9401800000

Made in: Denmark

Construction: The Circa stool comprises a black powder coated steel frame and a circular oak veneer, black Aluminum or upholstered seat. Circa is delivered assembled.

Maintenance: Clean with damp cloth. Textile upholstery: clean with textile or upholstery cleaner. Leather: clean with damp cloth. Use warm water with soap flakes. Frequent vacuuming with a soft fitting is recommended for both textile and leather to preserve color and appearance.



### Circa Barstool 75 cm Black Steel

Colli: 1

Size & Weight: H: 75 x W: 37 cm - 5,9 kg

Packing: Brown Box - H: 77 x L: 39 x D: 39 cm - 7,1 kg

Material: Frame in black powder coated steel. Seat available in lacquered oak veneer, black lacquered oak veneer or black lacquered aluminum.

Production time: 2 weeks



506090  
Oak



506091  
Black Oak



506093  
Black Aluminum

## CIRCA BARSTOOL 75 CM UPHOLSTERY

Design: Simon Legald, 2021

Duty Code: 9401800000

Made in: Denmark

Construction: The Circa stool comprises a black powder coated steel frame and a circular oak veneer, black Aluminum or upholstered seat. Circa is delivered assembled.

Maintenance: Clean with damp cloth. Textile upholstery: clean with textile or upholstery cleaner. Leather: clean with damp cloth. Use warm water with soap flakes. Frequent vacuuming with a soft fitting is recommended for both textile and leather to preserve color and appearance.



### Circa Barstool 75 cm Upholstery Black Steel

Colli: 1

Size & Weight: H: 75 x W: 37 cm - 5,9 kg

Packing: Brown Box - H: 77 x L: 39 x D: 39 cm - 7,1 kg

Material: Frame in black powder coated steel. Seat available in several types of upholstery, both textile and leather.

Production time: 2 weeks



506096  
MLF16 Black



506097  
Ultra Leather  
Brandy



506098  
Ultra Leather Black



506138  
MLF20 Sand

## CIRCA STOOL 45 CM

Design: Simon Legald, 2021  
 Duty Code: 9401800000  
 Made in: Denmark

Construction: The Circa stool comprises a black powder coated steel frame and a circular oak veneer, black Aluminum or upholstered seat. Circa is delivered assembled.

Maintenance: Clean with damp cloth. Textile upholstery: clean with textile or upholstery cleaner. Leather: clean with damp cloth. Use warm water with soap flakes. Frequent vacuuming with a soft fitting is recommended for both textile and leather to preserve color and appearance.



### Circa Stool 45 cm Black Steel

Colli: 1  
 Size & Weight: H: 45 x W: 37 cm - 3,55 kg  
 Packing: Brown Box - H: 47 x L: 39 x D: 39 cm - 4,45 kg  
 M3: 0,0715  
 Material: Frame in black powder coated steel. Seat available in lacquered oak veneer, black lacquered oak veneer or black lacquered aluminum.  
 Production time: 2 weeks



506070  
Oak



506071  
Black Oak



506073  
Black Aluminum

## CIRCA STOOL 45 CM UPHOLSTERY

Design: Simon Legald, 2021  
 Duty Code: 9401800000  
 Made in: Denmark

Construction: The Circa stool comprises a black powder coated steel frame and a circular oak veneer, black Aluminum or upholstered seat. Circa is delivered assembled.

Maintenance: Clean with damp cloth. Textile upholstery: clean with textile or upholstery cleaner. Leather: clean with damp cloth. Use warm water with soap flakes. Frequent vacuuming with a soft fitting is recommended for both textile and leather to preserve color and appearance.



### Circa Stool 45 cm Upholstery Black Steel

Colli: 1  
 Size & Weight: H: 45 x W: 37 cm - 3,55 kg  
 Packing: Brown Box - H: 47 x L: 39 x D: 39 cm - 4,45 kg  
 Material: Frame in black powder coated steel. Seat available in several types of upholstery, both textile and leather.  
 Production time: 2 weeks



506076  
MLF16 Black



506077  
Ultra Leather  
Brandy



506078  
Ultra Leather Black





506136  
MLF20 Sand

# CIRCA GLIDES

Duty Code: 9401999090

Construction: Different types of flooring require different types of glides.

Maintenance: We recommend to check the glides every 3-6 months. If worn down, please replace.

Circa Stool & Barstool Glides	
	506120 PA / Black / 4 pcs
	506121 PA w. felt / Black / 4 pcs

# CIRCUS VELOUR

Design: Simon Legald, 2013

Duty Code: 9401800000

Made in: Lithuania

Construction: Circus consists of hard foam in the bottom part and a softer foam on the upper part for good sitting comfort. The pouf is covered in velour. The pouf has a wooden plate at the bottom for stability.

Maintenance: Clean with textile or upholstery cleaner. Frequent vacuuming with a soft fitting is recommended to preserve color and appearance.

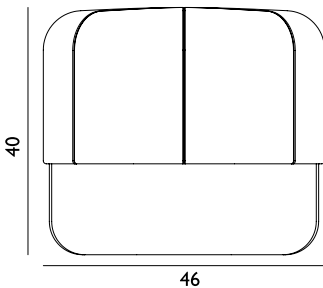

Circus Pouf Small			
Colli: 1			
Size & Weight: H: 40 x W: 46 x D: 46 cm - 7 kg			
Packing: Brown Box - H: 45 x L: 50 x D: 50 cm - 9 kg			
Material: Textile: JAB City Velvet, 100% Polyester, HR Foam			
	601063 Coffee		601064 Electric blue
	601070 Grey		601071 Blush
	601068 Beige		601072 Dark Red
	601069 Yellow		601073 Dark Blue
	601080 Rust		601081 Light Blue
	601082 Purple		

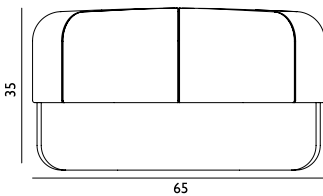

Circus Pouf Large			
Colli: 1			
Size & Weight: H: 35 x W: 65 x D: 65 cm - 12 kg			
Packing: Brown Box - H: 40 x L: 70 x D: 70 cm - 14 kg			
Material: Textile: JAB City Velvet, 100% Polyester, HR Foam			
	601066 Coffee		601067 Electric blue
	601075 Grey		601076 Blush
	601077 Dark Red		601078 Dark Blue
	601083 Beige		601084 Yellow
	601085 Rust		601086 Light Blue
	601087 Purple		

# CIRCUS DUO

Design: Simon Legald, 2022

Duty Code: 9401800000

Made in: Lithuania

Construction: Circus consists of hard foam in the bottom part and a softer foam on the upper part for good sitting comfort. The pouf is covered in Kvadrat Canvas and Kvadrat Vidar upholsteryes. The pouf has a wooden plate at the bottom for stability.

Maintenance: Clean with textile or upholstery cleaner. Frequent vacuuming with a soft fitting is recommended to preserve color and appearance.

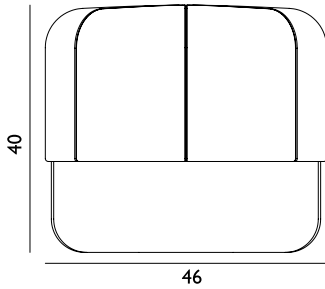

## Circus Pouf Duo Small

Colli: 1  
 Size & Weight: H: 40 x W: 46 x D: 46 cm - 7 kg  
 Packing: Brown Box - H: 45 x L: 50 x D: 50 cm - 9 kg  
 Material: Textile: Kvadrat Canvas 90% new wool worsted, 10% nylon. Kvadrat Vidar 94% new wool 6% nylon. HR Foam

 605811 Sand	 605812 Black	 605813 Rose	 605814 Orange
 605815 Green	 605816 Blue	 605817 Yellow	 605826 Light Blue

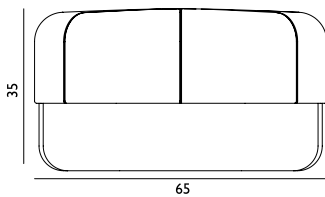

## Circus Pouf Duo Large

Colli: 1  
 Size & Weight: H: 35 x W: 65 x D: 65 cm - 12 kg  
 Packing: Brown Box - H: 40 x L: 70 x D: 70 cm - 14 kg  
 Material: Textile: Kvadrat Canvas 90% new wool worsted, 10% nylon. Kvadrat Vidar 94% new wool 6% nylon. HR Foam

 605818 Sand	 605819 Black	 605820 Rose	 605821 Orange
 605822 Green	 605823 Blue	 605824 Yellow	 605825 Light Blue

# DING

Design: Rudolph Schelling Webermann, 2013

Duty Code: 9403601000

Made in: China

Construction: The Ding table comes flat packed. The legs interlock easily by following the included manual. The legs have chamfered edges making the table stand sturdily on the floor and the round 12 mm thick sheet of glass rest solidly on the base.

Maintenance: Clean with damp cloth.

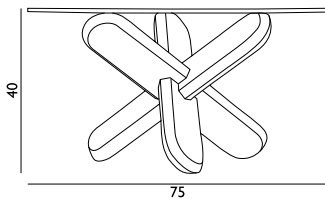

## Ding Table

Colli: 1  
 Size & Weight: H: 40 x Ø: 75 cm - 17 kg  
 Packing: Brown Box - H: 87 x L: 87 x D: 17 cm - 20 kg  
 Material: Glass, Lacquered Oak or Painted and Lacquered Oak

 602240 Glass / Oak	 602242 Glass / Black	 602243 Smoke / Oak	 602245 Smoke / Black
--------------------------------------------------------------------------------------------------------	----------------------------------------------------------------------------------------------------------	----------------------------------------------------------------------------------------------------------	------------------------------------------------------------------------------------------------------------

# DRAPE LOUNGE CHAIR LOW WOOD

---

Design: Simon Legald, 2022

Duty Code: 9401390000

Made in: Poland

**Construction:** A hard molded PU foam shell w. steel reinforcement ensures stability and strength, while a soft molded PU foam seat gives optimum comfort, as it shapes itself according to the body contours. Legs are either in powder-coated steel or wooden legs in lacquered oak or painted and lacquered oak. With piping following the desired upholstery chosen for the seat. Drape can be modified down to the smallest detail. It is consequently possible to choose one type of upholstery for the shell of the chair and another type for the piping, seat cover, and headrest if desired. Piping, headrest, and seat cover options in Ultra Leather are limited to the following four: Black 41599, Brandy 41574, Cognac 41598, Camel 41571.





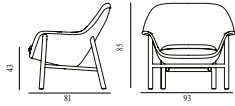



















**Maintenance:** Textile: Clean with textile or upholstery cleaner. Leather: Clean with a damp cloth. Frequent vacuuming with a soft fitting is recommended both for textile and leather to preserve color and appearance. Correct care and maintenance is important in preserving a product's attributes and appearance. Please see our related guide for further recommendations.





### Drape Lounge Chair Low Oak

Coll: 1  
 Size & Weight: H: 85 x W: 93 x D: 81 x SH: 43 cm - 15,5 kg  
 Packing: Brown Box - H: 86 x L: 96 x D: 92,7 cm - 21 kg  
 Material: Shell: Hard molded PU foam w. steel reinforcement. Cushion: Soft molded PU foam. Legs: Steel: Powder-coated steel. Wooden legs: Lacquered or painted and lacquered oak.  
 Color: All colors from Camira: Synergy, Main Line Flax, Aquarius, Oceanic, Yoredale. Sørensen: Ultra Leather. Kvadrat: Remix, Canvas, Steelcut Trio, Hallingdal, Divina, Divina MD, Divina Melange, Fiord, Vidar, Elle & Zero.  
 Production time: 6 weeks

	607000 Remix / Remix
	607001 Steelcut Trio / Steelcut Trio
	607002 Hallingdal / Hallingdal
	607003 Elle / Elle
	607004 Ultra Leather / Ultra Leather
	607005 Remix / Steelcut Trio
	607006 Remix / Hallingdal
	607007 Remix / Elle
	607008 Remix / Ultra Leather
	607009 Steelcut Trio / Remix
	607010 Steelcut Trio / Hallingdal
	607011 Steelcut Trio / Elle
	607012 Steelcut Trio / Ultra Leather
	607013 Hallingdal / Remix
	607014 Hallingdal / Steelcut Trio
	607015 Hallingdal / Elle
	607016 Hallingdal / Ultra Leather
	607017 Elle / Remix
	607018 Elle / Steelcut Trio
	607019 Elle / Hallingdal
	607020 Elle / Ultra Leather
	607021 Ultra Leather / Remix
	607022 Ultra Leather / Steelcut Trio
	607023 Ultra Leather / Hallingdal
	607024 Ultra Leather / Elle

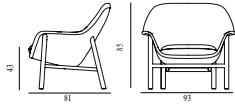

### Drape Lounge Chair Low Black Oak

Colli: 1  
 Size & Weight: H: 85 x W: 93 x D: 81 x SH: 43 cm - 15,5 kg  
 Packing: Brown Box - H: 86 x L: 96 x D: 92,7 cm - 21 kg  
 Material: Shell: Hard molded PU foam w. steel reinforcement. Cushion: Soft molded PU foam. Legs: Steel: Powder-coated steel. Wooden legs: Lacquered or painted and lacquered oak.  
 Color: All colors from Camira: Synergy, Main Line Flax, Aquarius, Oceanic, Yoredale. Sørensen: Ultra Leather. Kvadrat: Remix, Canvas, Steelcut Trio, Hallingdal, Divina, Divina MD, Divina Melange, Fiord, Vidar, Elle & Zero.  
 Production time: 6 weeks

	607025 Remix / Remix
	607026 Steelcut Trio / Steelcut Trio
	607027 Hallingdal / Hallingdal
	607028 Elle / Elle
	607029 Ultra Leather / Ultra Leather
	607030 Remix / Steelcut Trio
	607031 Remix / Hallingdal
	607032 Remix / Elle
	607033 Remix / Ultra Leather
	607034 Steelcut Trio / Remix
	607035 Steelcut Trio / Hallingdal
	607036 Steelcut Trio / Elle
	607037 Steelcut Trio / Ultra Leather
	607038 Hallingdal / Remix
	607039 Hallingdal / Steelcut Trio
	607040 Hallingdal / Elle
	607041 Hallingdal / Ultra Leather
	607042 Elle / Remix
	607043 Elle / Steelcut Trio
	607044 Elle / Hallingdal
	607045 Elle / Ultra Leather
	607046 Ultra Leather / Remix
	607047 Ultra Leather / Steelcut Trio
	607048 Ultra Leather / Hallingdal
	607049 Ultra Leather / Elle



# DRAPE LOUNGE CHAIR LOW STEEL

---

Design: Simon Legald, 2022

Duty Code: 9401390000

Made in: Poland

**Construction:** A hard molded PU foam shell w. steel reinforcement ensures stability and strength, while a soft molded PU foam seat gives optimum comfort, as it shapes itself according to the body contours. Legs are either in powder-coated steel or wooden legs in lacquered oak or painted and lacquered oak. With piping following the desired upholstery chosen for the seat. Drape can be modified down to the smallest detail. It is consequently possible to choose one type of upholstery for the shell of the chair and another type for the piping, seat cover, and headrest if desired. Piping, headrest, and seat cover options in Ultra Leather are limited to the following four: Black 41599, Brandy 41574, Cognac 41598, Camel 41571.

**Maintenance:** Textile: Clean with textile or upholstery cleaner. Leather: Clean with a damp cloth. Frequent vacuuming with a soft fitting is recommended both for textile and leather to preserve color and appearance. Correct care and maintenance is important in preserving a product's attributes and appearance. Please see our related guide for further recommendations.



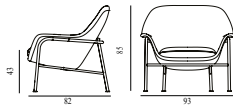

























### Drape Lounge Chair Low Grey Steel

Colli: 1  
 Size & Weight: H: 85 x W: 93 x D: 82 x SH: 43 cm - 18,5 kg  
 Packing: Brown Box - H: 86 x L: 96 x D: 92,7 cm - 24 kg  
 M3: 0,7653  
 Material: Shell: Hard molded PU foam w. steel reinforcement. Cushion: Soft molded PU foam. Legs: Steel: Powder-coated steel. Wooden legs: Lacquered or painted and lacquered oak.  
 Color: All colors from Camira: Synergy, Main Line Flax, Aquarius, Oceanic, Yoredale. Sørensen: Ultra Leather. Kvadrat: Remix, Canvas, Steelcut Trio, Hallingdal, Divina, Divina MD, Divina Melange, Fiord, Vidar, Elle & Zero.

Production time: 6 weeks



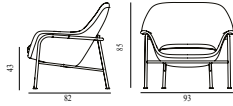





















	607050 Remix / Remix
	607051 Steelcut Trio / Steelcut Trio
	607052 Hallingdal / Hallingdal
	607053 Elle / Elle
	607054 Ultra Leather / Ultra Leather
	607055 Remix / Steelcut Trio
	607056 Remix / Hallingdal
	607057 Remix / Elle
	607058 Remix / Ultra Leather
	607059 Steelcut Trio / Remix
	607060 Steelcut Trio / Hallingdal
	607061 Steelcut Trio / Elle
	607062 Steelcut Trio / Ultra Leather
	607063 Hallingdal / Remix
	607064 Hallingdal / Steelcut Trio
	607065 Hallingdal / Elle
	607066 Hallingdal / Ultra Leather
	607067 Elle / Remix
	607068 Elle / Steelcut Trio
	607069 Elle / Hallingdal
	607070 Elle / Ultra Leather
	607071 Ultra Leather / Remix
	607072 Ultra Leather / Steelcut Trio
	607073 Ultra Leather / Hallingdal
	607074 Ultra Leather / Elle



### Drape Lounge Chair Low Black Steel

Colli: 1  
 Size & Weight: H: 85 x W: 93 x D: 82 x SH: 43 cm - 18,5 kg  
 Packing: Brown Box - H: 86 x L: 96 x D: 92,7 cm - 24 kg  
 M3: 0,7653  
 Material: Shell: Hard molded PU foam w. steel reinforcement. Cushion: Soft molded PU foam. Legs: Steel: Powder-coated steel. Wooden legs: Lacquered or painted and lacquered oak.  
 Color: All colors from Camira: Synergy, Main Line Flax, Aquarius, Oceanic, Yoredale. Sørensen: Ultra Leather. Kvadrat: Remix, Canvas, Steelcut Trio, Hallingdal, Divina, Divina MD, Divina Melange, Fiord, Vidar, Elle & Zero.

Production time: 6 weeks

	607075 Remix / Remix
	607076 Steelcut Trio / Steelcut Trio
	607077 Hallingdal / Hallingdal
	607078 Elle / Elle
	607079 Ultra Leather / Ultra Leather
	607080 Remix / Steelcut Trio
	607081 Remix / Hallingdal
	607082 Remix / Elle
	607083 Remix / Ultra Leather
	607084 Steelcut Trio / Remix
	607085 Steelcut Trio / Hallingdal
	607086 Steelcut Trio / Elle
	607087 Steelcut Trio / Ultra Leather
	607088 Hallingdal / Remix
	607089 Hallingdal / Steelcut Trio
	607090 Hallingdal / Elle
	607091 Hallingdal / Ultra Leather
	607092 Elle / Remix
	607093 Elle / Steelcut Trio
	607094 Elle / Hallingdal
	607095 Elle / Ultra Leather
	607096 Ultra Leather / Remix
	607097 Ultra Leather / Steelcut Trio
	607098 Ultra Leather / Hallingdal
	607099 Ultra Leather / Elle

# DRAPE LOUNGE CHAIR HIGH WOOD

---

Design: Simon Legald, 2022

Duty Code: 9401390000

Made in: Poland

Construction: A hard molded PU foam shell w. steel reinforcement ensures stability and strength, while a soft molded PU foam seat gives optimum comfort, as it shapes itself according to the body contours. Legs are either in powder-coated steel or wooden legs in lacquered oak or painted and lacquered oak. With piping following the desired upholstery chosen for the seat, Drape can be modified down to the smallest detail. It is consequently possible to choose one type of upholstery for the shell of the chair and another type for the piping, seat cover, and headrest if desired. Piping, headrest, and seat cover options in Ultra Leather are limited to the following four: Black 41599, Brandy 41574, Cognac 41598, Camel 41571.



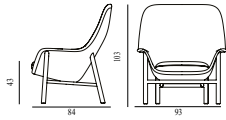





















Maintenance: Textile: Clean with textile or upholstery cleaner. Leather: Clean with a damp cloth. Frequent vacuuming with a soft fitting is recommended both for textile and leather to preserve color and appearance. Correct care and maintenance is important in preserving a product's attributes and appearance. Please see our related guide for further recommendations.



### Drape Lounge Chair High Oak

Colli: 1  
 Size & Weight: H: 103 x W: 93 x D: 84 x SH: 43 cm - 16,5 kg  
 Packing: Brown Box - H: 105 x L: 96 x D: 92,7 cm - 22 kg  
 M3: 0,9344  
 Material: Shell: Hard molded PU foam w. steel reinforcement. Cushion: Soft molded PU foam. Legs: Steel: Powder-coated steel. Wooden legs: Lacquered or painted and lacquered oak.  
 Color: All colors from Camira: Synergy, Main Line Flax, Aquarius, Oceanic, Yoredale. Sørensen: Ultra Leather. Kvadrat: Remix, Canvas, Steelcut Trio, Hallingdal, Divina, Divina MD, Divina Melange, Fiord, Vidar, Elle & Zero.

Production time: 6 weeks

	607100 Remix / Remix
	607101 Steelcut Trio / Steelcut Trio
	607102 Hallingdal / Hallingdal
	607103 Elle / Elle
	607104 Ultra Leather / Ultra Leather
	607105 Remix / Steelcut Trio
	607106 Remix / Hallingdal
	607107 Remix / Elle
	607108 Remix / Ultra Leather
	607109 Steelcut Trio / Remix
	607110 Steelcut Trio / Hallingdal
	607111 Steelcut Trio / Elle
	607112 Steelcut Trio / Ultra Leather
	607113 Hallingdal / Remix
	607114 Hallingdal / Steelcut Trio
	607115 Hallingdal / Elle
	607116 Hallingdal / Ultra Leather
	607117 Elle / Remix
	607118 Elle / Steelcut Trio
	607119 Elle / Hallingdal
	607120 Elle / Ultra Leather
	607121 Ultra Leather / Remix
	607122 Ultra Leather / Steelcut Trio
	607123 Ultra Leather / Hallingdal
	607124 Ultra Leather / Elle

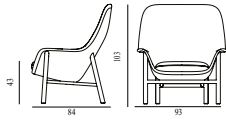

### Drape Lounge Chair High Black Oak

Colli: 1  
 Size & Weight: H: 103 x W: 93 x D: 84 x SH: 43 cm - 16,5 kg  
 Packing: Brown Box - H: 105 x L: 96 x D: 92,7 cm - 22 kg  
 M3: 0,9344  
 Material: Shell: Hard molded PU foam w. steel reinforcement. Cushion: Soft molded PU foam. Legs: Steel: Powder-coated steel. Wooden legs: Lacquered or painted and lacquered oak.  
 Color: All colors from Camira: Synergy, Main Line Flax, Aquarius, Oceanic, Yoredale. Sørensen: Ultra Leather. Kvadrat: Remix, Canvas, Steelcut Trio, Hallingdal, Divina, Divina MD, Divina Melange, Fiord, Vidar, Elle & Zero.  
 Production time: 6 weeks

	607125 Remix / Remix
	607126 Steelcut Trio / Steelcut Trio
	607127 Hallingdal / Hallingdal
	607128 Elle / Elle
	607129 Ultra Leather / Ultra Leather
	607130 Remix / Steelcut Trio
	607131 Remix / Hallingdal
	607132 Remix / Elle
	607133 Remix / Ultra Leather
	607134 Steelcut Trio / Remix
	607135 Steelcut Trio / Hallingdal
	607136 Steelcut Trio / Elle
	607137 Steelcut Trio / Ultra Leather
	607138 Hallingdal / Remix
	607139 Hallingdal / Steelcut Trio
	607140 Hallingdal / Elle
	607141 Hallingdal / Ultra Leather
	607142 Elle / Remix
	607143 Elle / Steelcut Trio
	607144 Elle / Hallingdal
	607145 Elle / Ultra Leather
	607146 Ultra Leather / Remix
	607147 Ultra Leather / Steelcut Trio
	607148 Ultra Leather / Hallingdal
	607149 Ultra Leather / Elle

# DRAPE LOUNGE CHAIR HIGH W. HEADREST WOOD

---

Design: Simon Legald, 2022

Duty Code: 9401710000

Made in: Poland

**Construction:** A hard molded PU foam shell w. steel reinforcement ensures stability and strength, while a soft molded PU foam seat gives optimum comfort, as it shapes itself according to the body contours. Legs are either in powder-coated steel or wooden legs in lacquered oak or painted and lacquered oak. With piping following the desired upholstery chosen for the seat, Drape can be modified down to the smallest detail. It is consequently possible to choose one type of upholstery for the shell of the chair and another type for the piping, seat cover, and headrest if desired. Piping, headrest, and seat cover options in Ultra Leather are limited to the following four: Black 41599, Brandy 41574, Cognac 41598, Camel 41571.





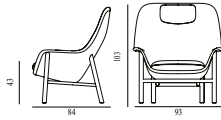



















**Maintenance:** Textile: Clean with textile or upholstery cleaner. Leather: Clean with a damp cloth. Frequent vacuuming with a soft fitting is recommended both for textile and leather to preserve color and appearance. Correct care and maintenance is important in preserving a product's attributes and appearance. Please see our related guide for further recommendations.





### Drape Lounge Chair High W. Headrest Oak

Colli: 1  
 Size & Weight: H: 103 x W: 93 x D: 84 x SH: 43 cm - 16,5 kg  
 Packing: Brown Box - H: 105 x L: 96 x D: 92,7 cm - 22 kg  
 M3: 0,9344  
 Material: Shell: Hard molded PU foam w. steel reinforcement. Cushion: Soft molded PU foam. Legs: Steel: Powder-coated steel. Wooden legs: Lacquered or painted and lacquered oak.  
 Color: All colors from Camira: Synergy, Main Line Flax, Aquarius, Oceanic, Yoredale. Sørensen: Ultra Leather. Kvadrat: Remix, Canvas, Steelcut Trio, Hallingdal, Divina, Divina MD, Divina Melange, Fiord, Vidar, Elle & Zero.  
 Production time: 6 weeks

	607200 Remix / Remix
	607201 Steelcut Trio / Steelcut Trio
	607202 Hallingdal / Hallingdal
	607203 Elle / Elle
	607204 Ultra Leather / Ultra Leather
	607205 Remix / Steelcut Trio
	607206 Remix / Hallingdal
	607207 Remix / Elle
	607208 Remix / Ultra Leather
	607209 Steelcut Trio / Remix
	607210 Steelcut Trio / Hallingdal
	607211 Steelcut Trio / Elle
	607212 Steelcut Trio / Ultra Leather
	607213 Hallingdal / Remix
	607214 Hallingdal / Steelcut Trio
	607215 Hallingdal / Elle
	607216 Hallingdal / Ultra Leather
	607217 Elle / Remix
	607218 Elle / Steelcut Trio
	607219 Elle / Hallingdal
	607220 Elle / Ultra Leather
	607221 Ultra Leather / Remix
	607222 Ultra Leather / Steelcut Trio
	607223 Ultra Leather / Hallingdal
	607224 Ultra Leather / Elle



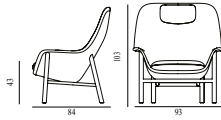

### Drape Lounge Chair High W. Headrest Black Oak

Colli: 1  
 Size & Weight: H: 103 x W: 93 x D: 84 x SH: 43 cm - 16,5 kg  
 Packing: Brown Box - H: 105 x L: 96 x D: 92,7 cm - 22 kg  
 M3: 0,9344  
 Material: Shell: Hard molded PU foam w. steel reinforcement. Cushion: Soft molded PU foam. Legs: Steel: Powder-coated steel. Wooden legs: Lacquered or painted and lacquered oak.  
 Color: All colors from Camira: Synergy, Main Line Flax, Aquarius, Oceanic, Yoredale. Sørensen: Ultra Leather. Kvadrat: Remix, Canvas, Steelcut Trio, Hallingdal, Divina, Divina MD, Divina Melange, Fiord, Vidar, Elle & Zero.  
 Production time: 6 weeks

	607225 Remix / Remix
	607226 Steelcut Trio / Steelcut Trio
	607227 Hallingdal / Hallingdal
	607228 Elle / Elle
	607229 Ultra Leather / Ultra Leather
	607230 Remix / Steelcut Trio
	607231 Remix / Hallingdal
	607232 Remix / Elle
	607233 Remix / Ultra Leather
	607234 Steelcut Trio / Remix
	607235 Steelcut Trio / Hallingdal
	607236 Steelcut Trio / Elle
	607237 Steelcut Trio / Ultra Leather
	607238 Hallingdal / Remix
	607239 Hallingdal / Steelcut Trio
	607240 Hallingdal / Elle
	607241 Hallingdal / Ultra Leather
	607242 Elle / Remix
	607243 Elle / Steelcut Trio
	607244 Elle / Hallingdal
	607245 Elle / Ultra Leather
	607246 Ultra Leather / Remix
	607247 Ultra Leather / Steelcut Trio
	607248 Ultra Leather / Hallingdal
	607249 Ultra Leather / Elle

# DRAPE LOUNGE CHAIR HIGH STEEL

---

Design: Simon Legald, 2022

Duty Code: 9401710000

Made in: Poland

Construction: A hard molded PU foam shell w. steel reinforcement ensures stability and strength, while a soft molded PU foam seat gives optimum comfort, as it shapes itself according to the body contours. Legs are either in powder-coated steel or wooden legs in lacquered oak or painted and lacquered oak. With piping following the desired upholstery chosen for the seat, Drape can be modified down to the smallest detail. It is consequently possible to choose one type of upholstery for the shell of the chair and another type for the piping, seat cover, and headrest if desired. Piping, headrest, and seat cover options in Ultra Leather are limited to the following four: Black 41599, Brandy 41574, Cognac 41598, Camel 41571.



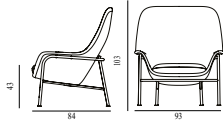





















Maintenance: Textile: Clean with textile or upholstery cleaner. Leather: Clean with a damp cloth. Frequent vacuuming with a soft fitting is recommended both for textile and leather to preserve color and appearance. Correct care and maintenance is important in preserving a product's attributes and appearance. Please see our related guide for further recommendations.



### Drape Lounge Chair High Grey Steel

Colli: 1  
 Size & Weight: H: 103 x W: 93 x D: 84 x SH: 43 cm - 19,5 kg  
 Packing: Brown Box - H: 105 x L: 96 x D: 92,7 cm - 25 kg  
 M3: 0,9344  
 Material: Shell: Hard molded PU foam w. steel reinforcement. Cushion: Soft molded PU foam. Legs: Steel: Powder-coated steel. Wooden legs: Lacquered or painted and lacquered oak.  
 Color: All colors from Camira: Synergy, Main Line Flax, Aquarius, Oceanic, Yoredale. Sørensen: Ultra Leather. Kvadrat: Remix, Canvas, Steelcut Trio, Hallingdal, Divina, Divina MD, Divina Melange, Fiord, Vidar, Elle & Zero.

Production time: 6 weeks

	607150 Remix / Remix
	607151 Steelcut Trio / Steelcut Trio
	607152 Hallingdal / Hallingdal
	607153 Elle / Elle
	607154 Ultra Leather / Ultra Leather
	607155 Remix / Steelcut Trio
	607156 Remix / Hallingdal
	607157 Remix / Elle
	607158 Remix / Ultra Leather
	607159 Steelcut Trio / Remix
	607160 Steelcut Trio / Hallingdal
	607161 Steelcut Trio / Elle
	607162 Steelcut Trio / Ultra Leather
	607163 Hallingdal / Remix
	607164 Hallingdal / Steelcut Trio
	607165 Hallingdal / Elle
	607166 Hallingdal / Ultra Leather
	607167 Elle / Remix
	607168 Elle / Steelcut Trio
	607169 Elle / Hallingdal
	607170 Elle / Ultra Leather
	607171 Ultra Leather / Remix
	607172 Ultra Leather / Steelcut Trio
	607173 Ultra Leather / Hallingdal
	607174 Ultra Leather / Elle

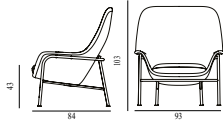

### Drape Lounge Chair High Black Steel

Colli: 1  
 Size & Weight: H: 103 x W: 93 x D: 84 x SH: 43 cm - 19,5 kg  
 Packing: Brown Box - H: 105 x L: 96 x D: 92,7 cm - 25 kg  
 M3: 0,9344  
 Material: Shell: Hard molded PU foam w. steel reinforcement. Cushion: Soft molded PU foam. Legs: Steel: Powder-coated steel. Wooden legs: Lacquered or painted and lacquered oak.  
 Color: All colors from Camira: Synergy, Main Line Flax, Aquarius, Oceanic, Yoredale. Sørensen: Ultra Leather. Kvadrat: Remix, Canvas, Steelcut Trio, Hallingdal, Divina, Divina MD, Divina Melange, Fiord, Vidar, Elle & Zero.

Production time: 6 weeks

	607175 Remix / Remix
	607176 Steelcut Trio / Steelcut Trio
	607177 Hallingdal / Hallingdal
	607178 Elle / Elle
	607179 Ultra Leather / Ultra Leather
	607180 Remix / Steelcut Trio
	607181 Remix / Hallingdal
	607182 Remix / Elle
	607183 Remix / Ultra Leather
	607184 Steelcut Trio / Remix
	607185 Steelcut Trio / Hallingdal
	607186 Steelcut Trio / Elle
	607187 Steelcut Trio / Ultra Leather
	607188 Hallingdal / Remix
	607189 Hallingdal / Steelcut Trio
	607190 Hallingdal / Elle
	607191 Hallingdal / Ultra Leather
	607192 Elle / Remix
	607193 Elle / Steelcut Trio
	607194 Elle / Hallingdal
	607195 Elle / Ultra Leather
	607196 Ultra Leather / Remix
	607197 Ultra Leather / Steelcut Trio
	607198 Ultra Leather / Hallingdal
	607199 Ultra Leather / Elle

# DRAPE LOUNGE CHAIR HIGH W. HEADREST STEEL

---

Design: Simon Legald, 2022

Duty Code: 9401390000

Made in: Poland

**Construction:** A hard molded PU foam shell w. steel reinforcement ensures stability and strength, while a soft molded PU foam seat gives optimum comfort, as it shapes itself according to the body contours. Legs are either in powder-coated steel or wooden legs in lacquered oak or painted and lacquered oak. With piping following the desired upholstery chosen for the seat, Drape can be modified down to the smallest detail. It is consequently possible to choose one type of upholstery for the shell of the chair and another type for the piping, seat cover, and headrest if desired. Piping, headrest, and seat cover options in Ultra Leather are limited to the following four: Black 41599, Brandy 41574, Cognac 41598, Camel 41571.





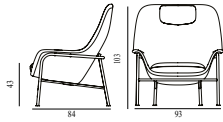



















**Maintenance:** Textile: Clean with textile or upholstery cleaner. Leather: Clean with a damp cloth. Frequent vacuuming with a soft fitting is recommended both for textile and leather to preserve color and appearance. Correct care and maintenance is important in preserving a product's attributes and appearance. Please see our related guide for further recommendations.





### Drape Lounge Chair High W. Headrest Grey Steel

Colli: 1  
 Size & Weight: H: 103 x W: 93 x D: 84 x SH: 43 cm - 19,5 kg  
 Packing: Brown Box - H: 105 x L: 96 x D: 92,7 cm - 25 kg  
 M3: 0,9344  
 Material: Shell: Hard molded PU foam w. steel reinforcement. Cushion: Soft molded PU foam. Legs: Steel: Powder-coated steel. Wooden legs: Lacquered or painted and lacquered oak.  
 Color: All colors from Camira: Synergy, Main Line Flax, Aquarius, Oceanic, Yoredale. Sørensen: Ultra Leather. Kvadrat: Remix, Canvas, Steelcut Trio, Hallingdal, Divina, Divina MD, Divina Melange, Fiord, Vidar, Elle & Zero.  
 Production time: 6 weeks

	607250 Remix / Remix
	607251 Steelcut Trio / Steelcut Trio
	607252 Hallingdal / Hallingdal
	607253 Elle / Elle
	607254 Ultra Leather / Ultra Leather
	607255 Remix / Steelcut Trio
	607256 Remix / Hallingdal
	607257 Remix / Elle
	607258 Remix / Ultra Leather
	607259 Steelcut Trio / Remix
	607260 Steelcut Trio / Hallingdal
	607261 Steelcut Trio / Elle
	607262 Steelcut Trio / Ultra Leather
	607263 Hallingdal / Remix
	607264 Hallingdal / Steelcut Trio
	607265 Hallingdal / Elle
	607266 Hallingdal / Ultra Leather
	607267 Elle / Remix
	607268 Elle / Steelcut Trio
	607269 Elle / Hallingdal
	607270 Elle / Ultra Leather
	607271 Ultra Leather / Remix
	607272 Ultra Leather / Steelcut Trio
	607273 Ultra Leather / Hallingdal
	607274 Ultra Leather / Elle

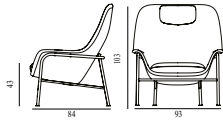

### Drape Lounge Chair High W. Headrest Black Steel

Colli: 1  
 Size & Weight: H: 103 x W: 93 x D: 84 x SH: 43 cm - 19,5 kg  
 Packing: Brown Box - H: 105 x L: 96 x D: 92,7 cm - 25 kg  
 M3: 0,9344  
 Material: Shell: Hard molded PU foam w. steel reinforcement. Cushion: Soft molded PU foam. Legs: Steel: Powder-coated steel. Wooden legs: Lacquered or painted and lacquered oak.  
 Color: All colors from Camira: Synergy, Main Line Flax, Aquarius, Oceanic, Yoredale. Sørensen: Ultra Leather. Kvadrat: Remix, Canvas, Steelcut Trio, Hallingdal, Divina, Divina MD, Divina Melange, Fiord, Vidar, Elle & Zero.  
 Production time: 6 weeks

	607275 Remix / Remix
	607276 Steelcut Trio / Steelcut Trio
	607277 Hallingdal / Hallingdal
	607278 Elle / Elle
	607279 Ultra Leather / Ultra Leather
	607280 Remix / Steelcut Trio
	607281 Remix / Hallingdal
	607282 Remix / Elle
	607283 Remix / Ultra Leather
	607284 Steelcut Trio / Remix
	607285 Steelcut Trio / Hallingdal
	607286 Steelcut Trio / Elle
	607287 Steelcut Trio / Ultra Leather
	607288 Hallingdal / Remix
	607289 Hallingdal / Steelcut Trio
	607290 Hallingdal / Elle
	607291 Hallingdal / Ultra Leather
	607292 Elle / Remix
	607293 Elle / Steelcut Trio
	607294 Elle / Hallingdal
	607295 Elle / Ultra Leather
	607296 Ultra Leather / Remix
	607297 Ultra Leather / Steelcut Trio
	607298 Ultra Leather / Hallingdal
	607299 Ultra Leather / Elle

# ERA LOUNGE CHAIR LOW WOOD

Design: Simon Legald, 2014  
 Awards: Red Dot Award 2016, Germany & German Design Award  
 2015 - "Special Mention", Germany

~~Duty Code: 94037000~~

Made in: Poland

- Price Groups:
- 1) Oceanic, Aquarius
  - 2) Remix, Main Line Flax, Synergy
  - 3) Canvas, Yoredale
  - 4) Steelcut Trio, City Velvet
  - 5) Divina, Divina MD, Divina Melange, Hallingdal, Fiord
  - 6) Zero, Vidar
  - 7) Elle, Ultra Læder

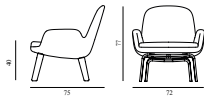

## Era Lounge Chair Low Oak

Coll: 1  
 Size & Weight: H: 77 x W: 72 x D: 74 x SH: 40 cm - 16,2 kg  
 Packing: Brown Box - H: 80,4 x L: 78,4 x D: 75,4 cm - 21 kg  
 Material: Shell: Hard Molded PU Foam w. Steel Reinforcement, Cushion:  
 Soft Molded PU Foam, Legs: Oak, Upholstery: See price groups.  
 Production time: 6 weeks

707021  
 Group 1

707022  
 Group 2

707023  
 Group 3

707024  
 Group 4

707025  
 Group 5

707026  
 Group 6

707027  
 Group 7

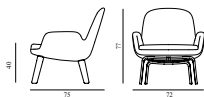

## Era Lounge Chair Low Black Oak

Coll: 1  
 Size & Weight: H: 77 x W: 72 x D: 74 x SH: 40 cm - 17 kg  
 Packing: Brown Box - H: 83 x L: 85 x D: 78 cm - 20 kg  
 Material: Shell: Hard Molded PU Foam w. Steel Reinforcement, Cushion:  
 Soft Molded PU Foam, Legs: Painted and Lacquered Oak Veneer,  
 Upholstery: See price groups.  
 Production time: 6 weeks

707041  
 Group 1

707042  
 Group 2

707043  
 Group 3

707044  
 Group 4

707045  
 Group 5

707046  
 Group 6

707047  
 Group 7



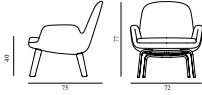

<b>Era Lounge Chair Low Walnut</b>	
Colli:	1
Size & Weight:	H: 77 x W: 83 x D: 83 x SH: 40 cm - 17 kg
Packing:	Brown Box - H: 80,4 x L: 78,4 x D: 75,4 cm - 21 kg
Material:	Shell: Hard Molded PU Foam w. Steel Reinforcement, Cushion: Soft Molded PU Foam, Legs: Walnut Veneer, Upholstery: See price groups.
Production time: 6 weeks	
707031	Group 1
707032	Group 2
707033	Group 3
707034	Group 4
707035	Group 5
707036	Group 6
707037	Group 7

## ERA LOUNGE CHAIR LOW STEEL & CHROME

Design: Simon Legald, 2014  
 Awards: Red Dot Award 2016, Germany & German Design Award  
 2015 - "Special Mention", Germany  
 Duty Code: 94037000  
 Made in: Poland  
 Price Groups: 1) Oceanic, Aquarius  
 2) Remix, Main Line Flax, Synergy  
 3) Canvas, Yoredale  
 4) Steelcut Trio, City Velvet  
 5) Divina, Divina MD, Divina Melange, Hallingdal, Fiord  
 6) Zero, Vidar  
 7) Elle, Ultra Læder

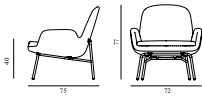

<b>Era Lounge Chair Low Black Steel</b>	
Colli:	1
Size & Weight:	H: 77 x W: 72 x D: 75 x SH: 40 cm - 16,2 kg
Packing:	Brown Box - H: 78,4 x L: 83,4 x D: 75,4 cm - 21 kg
Material:	Shell: Hard Molded PU Foam w. Steel Reinforcement, Cushion: Soft Molded PU Foam, Legs: Powder Coated Steel, Upholstery: See price groups.
Production time: 6 weeks	
707001	Group 1
707002	Group 2
707003	Group 3
707004	Group 4
707005	Group 5
707006	Group 6
707007	Group 7

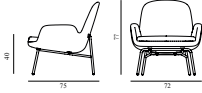

<b>Era Lounge Chair Low Chrome</b>	
Colli:	1
Size & Weight:	H: 77 x W: 72 x D: 74 x SH: 40 cm - 16,2 kg
Packing:	Brown Box - H: 80,4 x L: 78,4 x D: 75,4 cm - 21 kg
Material:	Shell: Hard Molded PU Foam w. Steel Reinforcement, Cushion: Soft Molded PU Foam, Legs: Chrome, Upholstery: See price groups.
Production time: 6 weeks	
707011	Group 1
707012	Group 2
707013	Group 3
707014	Group 4
707015	Group 5
707016	Group 6
707017	Group 7

## ERA LOUNGE CHAIR LOW SWIVEL

Design: Simon Legald, 2014  
 Awards: Red Dot Award 2016, Germany & German Design Award 2015 - "Special Mention", Germany  
 Duty Code: 94037000  
 Made in: Poland  
 Price Groups: 1) Oceanic, Aquarius  
 2) Remix, Main Line Flax, Synergy  
 3) Canvas, Yoredale  
 4) Steelcut Trio, City Velvet  
 5) Divina, Divina MD, Divina Melange, Hallingdal, Fiord  
 6) Zero, Vidar  
 7) Elle, Ultra Læder



<b>Era Lounge Chair Low Swivel Alu</b>	
Colli:	1
Size & Weight:	H: 77 x W: 83 x D: 83 x SH: 40 cm - 17 kg
Packing:	Brown Box - H: 83 x L: 85 x D: 78 cm - 24 kg
Material:	Shell: Hard Molded PU Foam w. Steel Reinforcement, Cushion: Soft Molded PU Foam, Legs: Aluminum, Upholstery: See price groups.
Production time: 6 weeks	
707051	Group 1
707052	Group 2
707053	Group 3
707054	Group 4
707055	Group 5
707056	Group 6
707057	Group 7



<b>Era Lounge Chair Low Swivel Black Alu</b> Colli: 1 Size & Weight: H: 77 x W: 83 x D: 83 x SH: 40 cm - 17 kg Packing: Brown Box - H: 83 x L: 85 x D: 78 cm - 24 kg Material: Shell: Hard Molded PU Foam w. Steel Reinforcement, Cushion: Soft Molded PU Foam, Legs: Powder Coated Aluminum, Upholstery: See price groups. Production time: 6 weeks	
707061	Group 1
707062	Group 2
707063	Group 3
707064	Group 4
707065	Group 5
707066	Group 6
707067	Group 7

## ERA LOUNGE CHAIR HIGH WOOD

Design: Simon Legald, 2014  
 Awards: Red Dot Award 2016, Germany & German Design Award 2015 - "Special Mention", Germany  
 Duty Code: 94037000  
 Made in: Poland  
 Price Groups: 1) Oceanic, Aquarius  
 2) Remix, Main Line Flax, Synergy  
 3) Canvas, Yoredale  
 4) Steelcut Trio, City Velvet  
 5) Divina, Divina MD, Divina Melange, Hallingdal, Fiord  
 6) Zero, Vidar  
 7) Elle, Ultra Læder

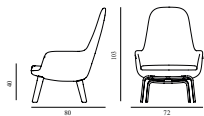

<b>Era Lounge Chair High Oak</b> Colli: 1 Size & Weight: H: 103 x W: 72 x D: 80 x SH: 40 cm - 15,6 kg Packing: Brown Box - H: 110 x L: 85 x D: 77 cm - 22,6 kg Material: Shell: Hard Molded PU Foam w. Steel Reinforcement, Cushion: Soft Molded PU Foam, Legs: Oak, Upholstery: See price groups. Production time: 6 weeks	
707091	Group 1
707092	Group 2
707093	Group 3
707094	Group 4
707095	Group 5
707096	Group 6
707097	Group 7

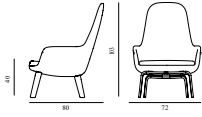

**Era Lounge Chair High Black Oak**

Colli: 1  
 Size & Weight: H: 103 x W: 72 x D: 80 x SH: 40 cm - 15,6 kg  
 Packing: Brown Box - H: 110 x L: 85 x D: 77 cm - 22,6 kg  
 Material: Shell: Hard Molded PU Foam w. Steel Reinforcement, Cushion:  
 Soft Molded PU Foam, Legs: Painted and Lacquered Oak Veneer,  
 Upholstery: See price groups.  
 Production time: 6 weeks

707111  
 Group 1

707112  
 Group 2

707113  
 Group 3

707114  
 Group 4

707115  
 Group 5

707116  
 Group 6

707117  
 Group 7

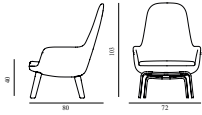

**Era Lounge Chair High Walnut**

Colli: 1  
 Size & Weight: H: 103 x W: 72 x D: 80 x SH: 40 cm - 15,6 kg  
 Packing: Brown Box - H: 110 x L: 85 x D: 77 cm - 22,6 kg  
 Material: Shell: Hard Molded PU Foam w. Steel Reinforcement, Cushion:  
 Soft Molded PU Foam, Legs: Walnut Veneer, Upholstery: See  
 price groups.  
 Production time: 6 weeks

707101  
 Group 1

707102  
 Group 2

707103  
 Group 3

707104  
 Group 4

707105  
 Group 5

707106  
 Group 6

707107  
 Group 7

# ERA LOUNGE CHAIR HIGH STEEL & CHROME

Design: Simon Legald, 2014  
 Awards: Red Dot Award 2016, Germany & German Design Award  
 2015 - "Special Mention", Germany  
 Duty Code: 94037000  
 Made in: Poland  
 Price Groups: 1) Oceanic, Aquarius  
 2) Remix, Main Line Flax, Synergy  
 3) Canvas, Yoredale  
 4) Steelcut Trio, City Velvet  
 5) Divina, Divina MD, Divina Melange, Hallingdal, Fiord  
 6) Zero, Vidar  
 7) Elle, Ultra Læder

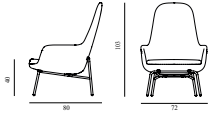

## Era Lounge Chair High Black Steel

Colli: 1  
 Size & Weight: H: 103 x W: 72 x D: 80 x SH: 40 cm - 16,6 kg  
 Packing: Brown Box - H: 110 x L: 85 x D: 77 cm - 23,6 kg  
 Material: Shell: Hard Molded PU Foam w. Steel Reinforcement, Cushion:  
 Soft Molded PU Foam, Legs: Powder Coated Steel, Upholstery:  
 See price groups.  
 Production time: 6 weeks

707071  
 Group 1

707072  
 Group 2

707073  
 Group 3

707074  
 Group 4

707075  
 Group 5

707076  
 Group 6

707077  
 Group 7



## Era Lounge Chair High Chrome

Colli: 1  
 Size & Weight: H: 103 x W: 72 x D: 80 x SH: 40 cm - 16,6 kg  
 Packing: Brown Box - H: 110 x L: 85 x D: 77 cm - 23,6 kg  
 Material: Shell: Hard Molded PU Foam w. Steel Reinforcement, Cushion:  
 Soft Molded PU Foam, Legs: Chrome, Upholstery: See price  
 groups.  
 Production time: 6 weeks

707081  
 Group 1

707082  
 Group 2

707083  
 Group 3

707084  
 Group 4

707085  
 Group 5

707086  
 Group 6

707087  
 Group 7

# ERA LOUNGE CHAIR HIGH SWIVEL

Design: Simon Legald, 2014  
 Awards: Red Dot Award 2016, Germany & German Design Award  
 2015 - "Special Mention", Germany  
 Duty Code: 94037000  
 Made in: Poland  
 Price Groups: 1) Oceanic, Aquarius  
 2) Remix, Main Line Flax, Synergy  
 3) Canvas, Yoredale  
 4) Steelcut Trio, City Velvet  
 5) Divina, Divina MD, Divina Melange, Hallingdal, Fiord  
 6) Zero, Vidar  
 7) Elle, Ultra Læder



## Era Lounge Chair High Swivel Alu

Colli: 1  
 Size & Weight: H: 103 x W: 83 x D: 83 x SH: 40 cm - 19,1 kg  
 Packing: Brown Box - H: 110 x L: 85 x D: 77 cm - 25,6 kg  
 Material: Shell: Hard Molded PU Foam w. Steel Reinforcement, Cushion:  
 Soft Molded PU Foam, Legs: Aluminum, Upholstery: See price  
 groups.  
 Production time: 6 weeks

707121  
 Group 1

707122  
 Group 2

707123  
 Group 3

707124  
 Group 4

707125  
 Group 5

707126  
 Group 6

707127  
 Group 7



## Era Lounge Chair High Swivel Black Alu

Colli: 1  
 Size & Weight: H: 103 x W: 83 x D: 83 x SH: 40 cm - 19,1 kg  
 Packing: Brown Box - H: 110 x L: 85 x D: 77 cm - 25,6 kg  
 Material: Shell: Hard Molded PU Foam w. Steel Reinforcement, Cushion:  
 Soft Molded PU Foam, Legs: Aluminum, Upholstery: See price  
 groups.  
 Production time: 6 weeks

707131  
 Group 1

707132  
 Group 2

707133  
 Group 3

707134  
 Group 4

707135  
 Group 5

707136  
 Group 6

707137  
 Group 7

# ERA SOFA WOOD

Design: Simon Legald, 2015  
 Awards: Red Dot Award 2016, Germany & German Design Award  
 2015 - "Special Mention", Germany  
 Duty Code: 94037000  
 Made in: Poland  
 Price Groups: 1) Oceanic, Aquarius  
 2) Remix, Main Line Flax, Synergy  
 3) Canvas, Yoredale  
 4) Steelcut Trio, City Velvet  
 5) Divina, Divina MD, Divina Melange, Hallingdal, Fiord  
 6) Zero, Vidar  
 7) Elle, Ultra Læder



## Era Sofa Oak

Colli: 1  
 Size & Weight: H: 78 x W: 145 x D: 77 x SH: 41 cm - 27,2 kg  
 Packing: Brown Box - H: 86,5 x L: 150,5 x D: 88,5 cm - 41,8 kg  
 Material: Shell: Hard Molded PU Foam w. Steel Reinforcement, Cushion:  
 Soft Molded PU Foam, Legs: Oak, Upholstery: See price groups  
 Production time: 6 weeks

707161  
 Group 1

707162  
 Group 2

707163  
 Group 3

707164  
 Group 4

707165  
 Group 5

707166  
 Group 6

707167  
 Group 7

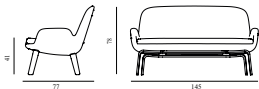

## Era Sofa Black Oak

Colli: 1  
 Size & Weight: H: 78 x W: 145 x D: 77 x SH: 41 cm - 27,2 kg  
 Packing: Brown Box - H: 86,5 x L: 150,5 x D: 88,5 cm - 41,8 kg  
 Material: Shell: Hard Molded PU Foam w. Steel Reinforcement, Cushion:  
 Soft Molded PU Foam, Legs: Painted and Lacquered Oak Veneer,  
 Upholstery: See price groups.  
 Production time: 6 weeks

707181  
 Group 1

707182  
 Group 2

707183  
 Group 3

707184  
 Group 4

707185  
 Group 5

707186  
 Group 6

707187  
 Group 7

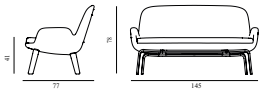

<b>Era Sofa Walnut</b>	
Colli:	1
Size & Weight:	H: 78 x W: 145 x D: 77 x SH: 41 cm - 27,2 kg
Packing:	Brown Box - H: 86,5 x L: 150,5 x D: 88,5 cm - 41,8 kg
Material:	Shell: Hard Molded PU Foam w. Steel Reinforcement, Cushion: Soft Molded PU Foam, Legs: Walnut Veneer, Upholstery: See price groups
Production time: 6 weeks	
707171	Group 1
707172	Group 2
707173	Group 3
707174	Group 4
707175	Group 5
707176	Group 6
707177	Group 7

## ERA SOFA STEEL & CHROME

Design: Simon Legald, 2015  
 Awards: Red Dot Award 2016, Germany & German Design Award  
 2015 - "Special Mention", Germany  
 Duty Code: 94037000  
 Made in: Poland  
 Price Groups: 1) Oceanic, Aquarius  
 2) Remix, Main Line Flax, Synergy  
 3) Canvas, Yoredale  
 4) Steelcut Trio, City Velvet  
 5) Divina, Divina MD, Divina Melange, Hallingdal, Fiord  
 6) Zero, Vidar  
 7) Elle, Ultra Læder

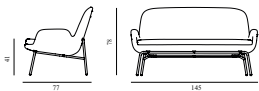

<b>Era Sofa Black Steel</b>	
Colli:	1
Size & Weight:	H: 78 x W: 145 x D: 77 x SH: 41 cm - 31,1 kg
Packing:	Brown Box - H: 86,5 x L: 150,5 x D: 88,5 cm - 41,6 kg
Material:	Shell: Hard Molded PU Foam w. Steel Reinforcement, Cushion: Soft Molded PU Foam, Legs: Powder Coated Steel, Upholstery: See price groups.
Production time: 6 weeks	
707141	Group 1
707142	Group 2
707143	Group 3
707144	Group 4
707145	Group 5
707146	Group 6
707147	Group 7



<p><b>Era Sofa Chrome</b></p> <p>Colli: 1</p> <p>Size &amp; Weight: H: 78 x W: 145 x D: 77 x SH: 41 cm - 31,1 kg</p> <p>Packing: Brown Box - H: 86,5 x L: 150,5 x D: 88,5 cm - 41,6 kg</p> <p>Material: Shell: Hard Molded PU Foam w. Steel Reinforcement, Cushion: Soft Molded PU Foam, Legs: Chrome, Upholstery: See price groups</p> <p>Production time: 6 weeks</p>
707151 Group 1
707152 Group 2
707153 Group 3
707154 Group 4
707155 Group 5
707156 Group 6
707157 Group 7

## ERA FOOTSTOOL WOOD

Design: Simon Legald, 2014  
Awards: Red Dot Award 2016, Germany & German Design Award 2015 - "Special Mention", Germany  
Duty Code: 94037000  
Made in: Poland  
Price Groups: 1) Oceanic, Aquarius  
2) Remix, Main Line Flax, Synergy  
3) Canvas, Yoredale  
4) Steelcut Trio, City Velvet  
5) Divina, Divina MD, Divina Melange, Hallingdal, Fiord  
6) Zero, Vidar  
7) Elle, Ultra Læder



<p><b>Era Footstool Oak</b></p> <p>Colli: 1</p> <p>Size &amp; Weight: H: 39 x W: 53 x D: 42 x SH: 39 cm - 6,4 kg</p> <p>Packing: Brown Box - H: 42,4 x L: 56,4 x D: 45,4 cm</p> <p>Material: Shell: Hard Molded PU Foam w. Steel Reinforcement, Cushion: Soft Molded PU Foam, Legs: Oak, Upholstery: See price groups.</p> <p>Production time: 6 weeks</p>
707211 Group 1
707212 Group 2
707213 Group 3
707214 Group 4
707215 Group 5
707216 Group 6
707217 Group 7



<b>Era Footstool Black Oak</b>	
Colli:	1
Size & Weight:	H: 39 x W: 53 x D: 42 x SH: 39 cm - 6,4 kg
Packing:	Brown Box - H: 42,4 x L: 56,4 x D: 45,4 cm
Material:	Shell: Hard Molded PU Foam w. Steel Reinforcement, Cushion: Soft Molded PU Foam, Legs: Painted and Lacquered Oak Veneer, Upholstery: See price groups
Production time: 6 weeks	
707231	Group 1
707232	Group 2
707233	Group 3
707234	Group 4
707235	Group 5
707236	Group 6
707237	Group 7



<b>Era Footstool Walnut</b>	
Colli:	1
Size & Weight:	H: 39 x W: 53 x D: 42 x SH: 39 cm - 6,4 kg
Packing:	Brown Box - H: 42,4 x L: 56,4 x D: 45,4 cm
Material:	Shell: Hard Molded PU Foam w. Steel Reinforcement, Cushion: Soft Molded PU Foam, Legs: Walnut Veneer, Upholstery: See price groups.
Production time: 6 weeks	
707221	Group 1
707222	Group 2
707223	Group 3
707224	Group 4
707225	Group 5
707226	Group 6
707227	Group 7

# ERA FOOTSTOOL STEEL & CHROME

Design: Simon Legald, 2014  
 Awards: Red Dot Award 2016, Germany & German Design Award  
 2015 - "Special Mention", Germany  
 Duty Code: 94037000  
 Made in: Poland  
 Price Groups: 1) Oceanic, Aquarius  
 2) Remix, Main Line Flax, Synergy  
 3) Canvas, Yoredale  
 4) Steelcut Trio, City Velvet  
 5) Divina, Divina MD, Divina Melange, Hallingdal, Fiord  
 6) Zero, Vidar  
 7) Elle, Ultra Læder



## Era Footstool Black Steel

Colli: 1  
 Size & Weight: H: 39 x W: 53 x D: 42 x SH: 39 cm - 6,6 kg  
 Packing: Brown Box - H: 42,4 x L: 56,4 x D: 45,4 cm  
 Material: Shell: Hard Molded PU Foam w. Steel Reinforcement, Cushion:  
 Soft Molded PU Foam, Legs: Powder Coated Steel, Upholstery:  
 See price group  
 Production time: 6 weeks

707191  
 Group 1

707192  
 Group 2

707193  
 Group 3

707194  
 Group 4

707195  
 Group 5

707196  
 Group 6

707197  
 Group 7



## Era Footstool Chrome

Colli: 1  
 Size & Weight: H: 39 x W: 53 x D: 42 x SH: 39 cm - 6,6 kg  
 Packing: Brown Box - H: 42,4 x L: 56,4 x D: 45,4 cm  
 Material: Shell: Hard Molded PU Foam w. Steel Reinforcement, Cushion:  
 Soft Molded PU Foam, Legs: Chrome, Upholstery: See price  
 groups.  
 Production time: 6 weeks

707201  
 Group 1

707202  
 Group 2

707203  
 Group 3

707204  
 Group 4

707205  
 Group 5

707206  
 Group 6

707207  
 Group 7

# ERA FOOTSTOOL SWIVEL ALU

Design: Simon Legald, 2016  
 Awards: Red Dot Award 2016, Germany & German Design Award  
 2015 - "Special Mention", Germany  
 Duty Code: 94037000  
 Made in: Poland  
 Price Groups: 1) Oceanic, Aquarius  
 2) Remix, Main Line Flax, Synergy  
 3) Canvas, Yoredale  
 4) Steelcut Trio, City Velvet  
 5) Divina, Divina MD, Divina Melange, Hallingdal, Fiord  
 6) Zero, Vidar  
 7) Elle, Ultra Læder



## Era Footstool Swivel Alu

Colli: 1  
 Size & Weight: H: 39 x W: 53 x D: 42 x SH: 39 cm - 6,6 kg  
 Packing: Brown Box - H: 42,4 x L: 56,4 x D: 45,4 cm  
 Material: Shell: Hard Molded PU Foam w. Steel Reinforcement, Cushion:  
 Soft Molded PU Foam, Legs: Aluminum, Upholstery: See price  
 groups.  
 Production time: 6 weeks

707241  
 Group 1

707242  
 Group 2

707243  
 Group 3

707244  
 Group 4

707245  
 Group 5

707246  
 Group 6

707247  
 Group 7

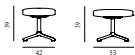

## Era Footstool Swivel Black Alu

Colli: 1  
 Size & Weight: H: 39 x W: 53 x D: 42 x SH: 39 cm - 6,6 kg  
 Packing: Brown Box - H: 42,4 x L: 56,4 x D: 45,4 cm  
 Material: Shell: Hard Molded PU Foam w. Steel Reinforcement, Cushion:  
 Soft Molded PU Foam, Legs: Aluminum, Upholstery: See price  
 groups.  
 Production time: 6 weeks

707251  
 Group 1

707252  
 Group 2

707253  
 Group 3

707254  
 Group 4

707255  
 Group 5

707256  
 Group 6

707257  
 Group 7

# ERA TABLE

Design: Simon Legald, 2016  
 Duty Code: 6802910090  
 Made in: China  
 Construction: Era Table is delivered assembled. As the table top is a natural material, the color may vary slightly from product to product.  
 Maintenance: Clean with damp cloth.

**Era Table 60 x 48,5 cm Alu**  
 Colli: 1  
 Size & Weight: H: 45 x W: 48,5 x L: 60 cm - 17 kg  
 Packing: Brown Box - H: 56 x L: 68 x D: 57 cm - 19 kg  
 Material: Top plate: Granite, Legs: Aluminum



# ERA GLIDES

Duty Code: 9401999090  
 Construction: Different types of flooring require different types of glides.  
 Maintenance: We recommend to check the glides every 3-6 months. If worn down, please replace.

**Era Lounge Chair, Era Sofa & Era Footstool Glides**

900125  
 PE for steel /  
 Black /  
 4pcs

# FORM CHAIR WOOD

Design: Simon Legald, 2016  
 Awards: German Design Award 2016, Germany - "Special Mention" & IF Product Design Award 2016, Germany  
 Duty Code: 9401790000  
 Made in: Denmark  
 Construction: The shell is made of high-quality polypropylene (PP) and has been molded using one single injection, ensuring an extremely strong construction with the finest surface possible. The molded connectors match the legs in color, creating a seamless transition from legs to shell. Form is delivered assembled.  
 Maintenance: Clean with damp cloth.

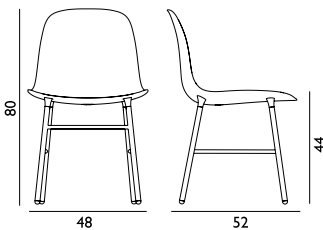

**Form Chair Oak**  
 Colli: 1  
 Size & Weight: H: 80 x W: 48 x D: 52 x SH: 44 cm - 4 kg  
 Packing: Brown Box - H: 97,3 x L: 51 x D: 60 cm (2 pcs) - 11 kg  
 Material: Shell: Polypropylene, Legs: Oak.  
 Production time: 2 weeks

 602816 White	 602817 Grey	 602818 Black	 602819 Blue
 602820 Green	 602821 Red		

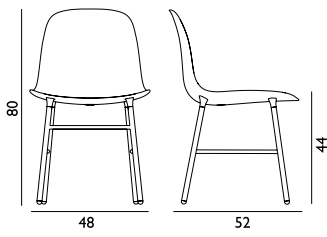

### Form Chair Black Oak

Colli: 1  
 Size & Weight: H: 80 x W: 48 x D: 52 x SH: 44 cm - 4 kg  
 Packing: Brown Box - H: 97,3 x L: 51 x D: 60 cm (2 pcs) - 11 kg  
 Material: Shell: Polypropylene, Legs: Painted and Lacquered Oak.  
 Production time: 2 weeks

 603200 White	 603201 Grey	 603202 Black	 603203 Blue
		 603204 Green	 603205 Red

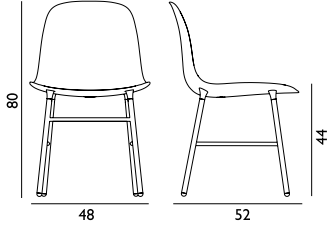

### Form Chair Walnut

Colli: 1  
 Size & Weight: H: 80 x W: 48 x D: 52 x SH: 44 cm - 4 kg  
 Packing: Brown Box - H: 97,3 x L: 51 x D: 60 cm (2 pcs) - 11 kg  
 Material: Shell: Polypropylene, Legs: Walnut.  
 Production time: 2 weeks

 602822 White	 602823 Grey	 602824 Black	 602825 Blue
		 602826 Green	 602827 Red

## FORM CHAIR FULL UPHOLSTERY WOOD

- Design: Simon Legald, 2016  
 Awards: German Design Award 2016, Germany - "Special Mention" & IF Product Design Award 2016, Germany  
 Duty Code: 9401610000  
 Made in: Poland  
 Construction: The shell is made of high-quality polypropylene (PP) and has been molded using one single injection, ensuring an extremely strong construction with the finest surface possible. The molded connectors are made from wood. The shell is upholstered with upholstery of your choice. Form is delivered assembled.  
 Maintenance: Textile: Clean with textile or upholstery cleaner. Leather: Clean with a damp cloth. Use warm water with soap flakes. Frequent vacuuming with a soft fitting is recommended for both textile and leather to preserve color and appearance.

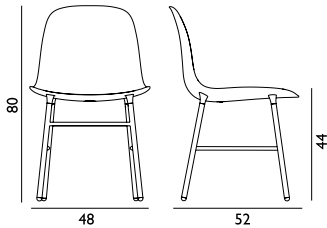

### Form Chair Full Upholstery Black Oak



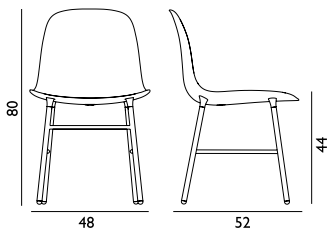

Colli: 1  
 Size & Weight: H: 80 x W: 48 x D: 52 x SH: 44 cm - 4,7 kg  
 Packing: Brown Box - H: 89 x L: 56 x D: 56 cm (2 pcs) - 14 kg  
 Material: Shell: Polypropylene, PU Foam, Textile: Sorensen Leather/Ultra Leather, JAB/City Velvet, Camira/Main Line Flax, Camira/Synergy, Camira/Aquarius, Camira/Oceanic, Camira/Yoredale. Legs: Painted and Lacquered Oak.  
 Production time: 6 weeks

 1350262 Ultra Leather
 1400853 City Velvet vol 2
 1400954 Main Line flax
 1400955 Synergy
 1401282 Aquarius
 1401283 Oceanic
 1401284 Yoredale



### Form Chair Full Upholstery Oak

Colli: 1  
 Size & Weight: H: 80 x W: 48 x D: 52 x SH: 44 cm - 4,7 kg  
 Packing: Brown Box - H: 89 x L: 56 x D: 56 cm (2 pcs) - 14 kg  
 Material: Shell: Polypropylene, PU Foam, Textile: Sorensen Leather/Ultra Leather, JAB/City Velvet, Camira/Main Line Flax, Camira/Synergy, Camira/Aquarius, Camira/Oceanic, Camira/Yoredale. Legs: Oak.  
 Production time: 6 weeks

	1350550 Ultra Leather
	1400854 City Velvet vol 2
	1400956 Main Line flax
	1400957 Synergy
	1401286 Aquarius
	1401287 Oceanic
	1401288 Yoredale

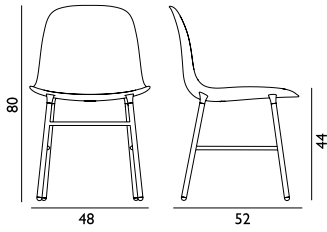

### Form Chair Full Upholstery Walnut

Colli: 1  
 Size & Weight: H: 80 x W: 48 x D: 52 x SH: 44 cm - 4,7 kg  
 Packing: Brown Box - H: 89 x L: 56 x D: 56 cm (2 pcs) - 14 kg  
 Material: Shell: Polypropylene, PU Foam, Textile: Sorensen Leather/Ultra Leather, JAB/City Velvet, Camira/Main Line Flax, Camira/Synergy, Camira/Aquarius, Camira/Oceanic, Camira/Yoredale. Legs: Walnut.  
 Production time: 6 weeks

	1350850 Ultra Leather
	1400855 City Velvet vol 2
	1400958 Main Line flax
	1400959 Synergy
	1401290 Aquarius
	1401291 Oceanic
	1401292 Yoredale

# FORM CHAIR STEEL

Design: Simon Legald, 2014  
 Awards: German Design Award 2016, Germany - "Special Mention" & IF Product Design Award 2016, Germany  
 Duty Code: 9401790000  
 Made in: Denmark  
 Construction: The shell is made of high-quality polypropylene (PP) and has been molded using one single injection, ensuring an extremely strong construction with the finest surface possible. The molded connectors match the legs in color, creating a seamless transition from legs to shell. Form is delivered assembled.  
 Maintenance: Clean with damp cloth.

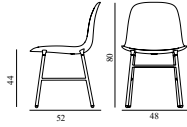

## Form Chair Steel

Coll: I  
 Size & Weight: H: 80 x W: 48 x D: 52 x SH: 44 cm - 5 kg  
 Packing: Brown Box - H: 97,3 x L: 51 x D: 60 cm (2 pcs) - 12,5 kg  
 Material: Shell: Polypropylene, Legs: Powder Coated Steel.  
 Production time: 2 weeks

 602810 White	 602811 Grey	 602812 Black	 602813 Blue
 602814 Green	 602815 Red		

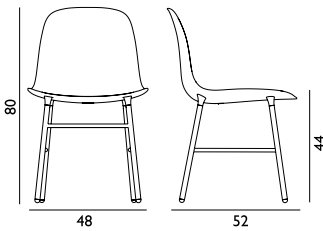

## Form Chair Chrome

Coll: I  
 Size & Weight: H: 80 x W: 48 x D: 52 x SH: 44 cm - 5 kg  
 Packing: Brown Box - H: 97,3 x L: 51 x D: 60 cm (2 pcs) - 12,5 kg  
 Material: Shell: Polypropylene, Legs: Chrome.  
 Production time: 2 weeks

 603168 White	 603169 Grey	 603170 Black	 603171 Blue
 603172 Green	 603173 Red		

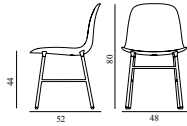

## Form Chair Brass

Coll: I  
 Size & Weight: H: 80 x W: 48 x D: 52 x SH: 44 cm - 5 kg  
 Packing: Brown Box - H: 97,3 x L: 51 x D: 60 cm (2 pcs) - 12,5 kg  
 Material: Shell: Polypropylene, Legs: Brass Plated Steel.  
 Production time: 2 weeks

 1400900 White	 1400901 Grey	 1400902 Black	 1400903 Blue
 1400904 Green	 1400905 Red		



# FORM CHAIR FULL UPHOLSTERY STEEL

Design: Simon Legald, 2015  
 Awards: German Design Award 2016, Germany - "Special Mention" & IF Product Design Award 2016, Germany  
 Duty Code: 9401710000  
 Made in: Poland  
 Construction: The shell is made of high-quality polypropylene (PP) and has been molded using one single injection, ensuring an extremely strong construction with the finest surface possible. The molded connectors match the legs in color, creating a seamless transition from legs to shell. Form is delivered assembled.  
 Maintenance: Textile: Clean with textile or upholstery cleaner. Leather: Clean with a damp cloth. Use warm water with soap flakes. Frequent vacuuming with a soft fitting is recommended for both textile and leather to preserve color and appearance.

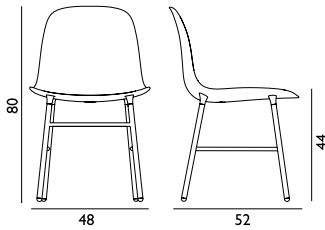

## Form Chair Full Upholstery Steel

Colli: 1  
 Size & Weight: H: 80 x W: 48 x D: 52 x SH: 44 cm - 6 kg  
 Packing: Brown Box - H: 89 x L: 56 x D: 56 cm (2 pcs) - 9 kg  
 Material: Shell: Polypropylene, PU Foam, Textile: Sorensen Leather/Ultra Leather  
 Production time: 6 weeks

	I350250 Ultra Leather
	I400850 City Velvet vol 2
	I400948 Main Line flax
	I400949 Synergy
	I401270 Aquarius
	I401271 Oceanic
	I401272 Yoredale



## Form Chair Full Upholstery Chrome

Colli: 1  
 Size & Weight: H: 80 x W: 48 x D: 52 x SH: 44 cm - 6 kg  
 Packing: Brown Box - H: 89 x L: 56 x D: 56 cm (2 pcs) - 9 kg  
 Material: Shell: Polypropylene, PU Foam, Textile: Sorensen Leather/Ultra Leather, JAB/City Velvet, Camira/Main Line Flax, Camira/Synergy, Camira/Aquarius, Camira/Oceanic, Camira/Yoredale. Legs: Chrome.  
 Production time: 6 weeks

	I350256 Ultra Leather
	I400851 City Velvet vol 2
	I400950 Main Line flax
	I400951 Synergy
	I401274 Aquarius
	I401275 Oceanic
	I401276 Yoredale

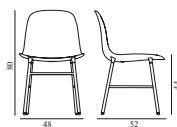

### Form Chair Full Upholstery Brass

Size & Weight: H: 80 x W: 48 x D: 52 x SH: 44 cm - 6 kg  
 Packing: Brown Box - H: 89 x L: 56 x D: 56 cm (2 pcs) - 9 kg  
 Material: Shell: Polypropylene, PU Foam, Textile: Sorensen Leather/ Ultra Leather, JAB/City Velvet, Camira/Main Line Flax, Camira/Synergy, Camira/Aquarius, Camira/Oceanic, Camira/Yoredale. Legs: Brass Plated Steel.  
 Production time: 6 weeks

	I400852 City Velvet vol 2
	I400911 Ultra Leather
	I400952 Main Line flax
	I400953 Synergy
	I401278 Aquarius
	I401279 Oceanic
	I401280 Yoredale

## FORM CHAIR STACKING STEEL

Design: Simon Legald, 2022  
 Duty Code: 9401790000  
 Made in: Denmark

Construction: The shell is made of high-quality polypropylene (PP) and has been molded using one single injection, ensuring an extremely strong construction with the finest surface possible. The molded connectors match the legs in color, creating a seamless transition from legs to shell. Form is delivered assembled.

Maintenance: Clean with damp cloth.

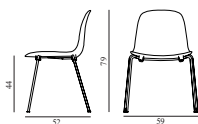

### Form Chair Stacking Black Steel

Colli: 1  
 Size & Weight: H: 79 x W: 58,5 x D: 52 x SH: 44,2 cm - 4,8 kg  
 Packing: Brown Box - H: 90,5 x L: 59,4 x D: 56 cm (2 pcs) - 11,6 kg  
 M3: 0,301  
 Material: Shell: Polypropylene, Legs: Powder Coated Steel.  
 Color: White, Grey, Black, Green, Blue, Red  
 Production time: 2 weeks

	607780 White
	607781 Grey
	607782 Black
	607783 Blue
	607784 Green
	607785 Red

# FORM CHAIR STACKING FULL UPHOLSTERY STEEL

Design: Simon Legald, 2022

Duty Code: 9401710000

Made in: Poland





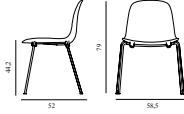

Construction: The shell is made of high-quality polypropylene (PP) and has been molded using one single injection, ensuring an extremely strong construction with the finest surface possible. The molded connectors match the legs in color, creating a seamless transition from legs to shell. Form is delivered assembled.

Maintenance: Textile: Clean with textile or upholstery cleaner. Leather: Clean with a damp cloth. Use warm water with soap flakes. Frequent vacuuming with a soft fitting is recommended for both textile and leather to preserve color and appearance.



## Form Chair Stacking Full Upholstery Black Steel

Colli: 1  
 Size & Weight: H: 79 x W: 58,5 x D: 52 x SH: 44,2 cm - 4,8 kg  
 Packing: Brown Box - H: 90,5 x L: 59,4 x D: 56 cm (2 pcs) - 11,6 kg  
 Material: Shell: Polypropylene, PU Foam, Textile: Camira/Main Line Flax, Camira/Synergy, Camira/Aquarius, Camira/Oceanic, Camira/Yoredale, Sørensen Leather/Ultra Leather. Legs: Powder Coated Steel.  
 Color: All colors from Camira: Synergy, Main Line Flax, Aquarius, Oceanic, Yoredale. Sørensen: Ultra Leather. Kvadrat: Remix, Canvas, Steelcut Trio, Hallingdal, Divina, Divina MD, Divina Melange, Fiord, Vidar, Elle & Zero.  
 Production time: 6 weeks

	607765 Main Line Flax
	607766 Synergy
	607767 Ultra Leather
	607768 Aquarius
	607769 Oceanic
	607770 Yoredale

# FORM ARMCHAIR WOOD

Design: Simon Legald, 2016

Awards: German Design Award 2016, Germany - "Special Mention" & IF Product Design Award 2016, Germany

Duty Code: 9401790000

Made in: Denmark

Construction: Form is delivered assembled. The plastic type is Polypropylene (PP). Armchair armrest height: 65,8 cm

Maintenance: Clean with damp cloth.

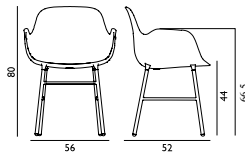

## Form Armchair Black Oak

Colli: 1  
 Size & Weight: H: 80 x W: 56 x D: 52 x SH: 44 cm - 5,3 kg  
 Packing: Brown Box - H: 81,5 x L: 54 x D: 54 cm - 6,5 kg  
 Material: Shell: Polypropylene, Legs: Painted and Lacquered Oak.  
 Production time: 2 weeks

	603206 White		603207 Grey		603208 Black		603209 Blue
	603210 Green		603211 Red				

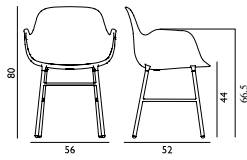

### Form Armchair Oak

Colli: 1  
 Size & Weight: H: 80 x W: 56 x D: 52 x SH: 44 cm - 5,3 kg  
 Packing: Brown Box - H: 81,5 x L: 54 x D: 54 cm - 6,5 kg  
 Material: Shell: Polypropylene, Legs: Oak.  
 Production time: 2 weeks

 602762 White	 602763 Grey	 602764 Black	 602765 Blue
 602766 Green	 602767 Red		

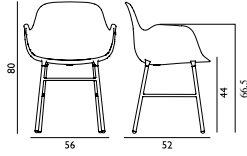

### Form Armchair Walnut

Colli: 1  
 Size & Weight: H: 80 x W: 56 x D: 52 x SH: 44 cm - 5,3 kg  
 Packing: Brown Box - H: 81,5 x L: 54 x D: 54 cm - 6,5 kg  
 Material: Shell: Polypropylene, Legs: Walnut.  
 Production time: 2 weeks

 602768 White	 602769 Grey	 602770 Black	 602771 Blue
 602772 Green	 602773 Red		

## FORM ARMCHAIR FULL UPHOLSTERY WOOD

Design: Simon Legald, 2016  
 Awards: German Design Award 2016, Germany - "Special Mention" & IF Product Design Award 2016, Germany  
 Duty Code: 9401710000  
 Made in: Poland

Construction: The shell is made of high-quality polypropylene (PP) and has been molded using one single injection, ensuring an extremely strong construction with the finest surface possible. The molded connectors are made from wood. The shell is upholstered with upholstery of your choice. Form is delivered assembled. Armchair armrest height: 65,8 cm

Maintenance: Textile: Clean with textile or upholstery cleaner. Leather: Clean with a damp cloth. Use warm water with soap flakes. Frequent vacuuming with a soft fitting is recommended for both textile and leather to preserve color and appearance.

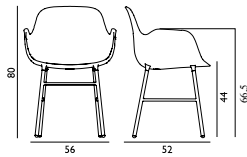

### Form Armchair Full Upholstery Black Oak

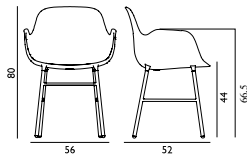

Colli: 1  
 Size & Weight: H: 80 x W: 56 x D: 52 x SH: 44 cm - 5,5 kg  
 Packing: Brown Box - H: 90 x L: 55,5 x D: 56,5 cm - 10 kg  
 Material: Shell: Polypropylene, PU Foam, Textile: Sørensen Leather/Ultra Leather, JAB/City Velvet, Camira/Main Line Flax, Camira/Synergy, Camira/Aquarius, Camira/Oceanic, Camira/Yoredale.  
 Legs: Painted and Lacquered Oak.  
 Production time: 6 weeks

 1360262 Ultra Leather
 1400867 City Velvet vol 2
 1400982 Main Line flax
 1400983 Synergy
 1401338 Aquarius
 1401339 Oceanic
 1401340 Yoredale



### Form Armchair Full Upholstery Oak

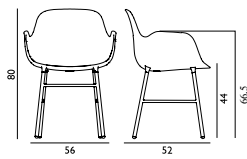

Colli: 1  
 Size & Weight: H: 80 x W: 56 x D: 52 x SH: 44 cm - 5,5 kg  
 Packing: Brown Box - H: 90 x L: 55,5 x D: 56,5 cm - 10 kg  
 Material: Shell: Polypropylene, PU Foam, Textile: Sorensen Leather/Ultra Leather, JAB/City Velvet, Camira/Main Line Flax, Camira/Synergy, Camira/Aquarius, Camira/Oceanic, Camira/Yoredale. Legs: Oak.  
 Production time: 6 weeks

	1360550 Ultra Leather
	1400868 City Velvet vol 2
	1400984 Main Line flax
	1400985 Synergy
	1401342 Aquarius
	1401343 Oceanic
	1401344 Yoredale



### Form Armchair Full Upholstery Walnut

Colli: 1  
 Size & Weight: H: 80 x W: 56 x D: 52 x SH: 44 cm - 5,5 kg  
 Packing: Brown Box - H: 90 x L: 55,5 x D: 56,5 cm - 10 kg  
 Material: Shell: Polypropylene, PU Foam, Textile: Sorensen Leather/Ultra Leather, JAB/City Velvet, Camira/Main Line Flax, Camira/Synergy, Camira/Aquarius, Camira/Oceanic, Camira/Yoredale. Legs: Walnut.  
 Production time: 6 weeks

	1360850 Ultra Leather
	1400869 City Velvet vol 2
	1400986 Main Line flax
	1400987 Synergy
	1401346 Aquarius
	1401347 Oceanic
	1401348 Yoredale

## FORM ARMCHAIR STEEL

Design: Simon Legald, 2014  
 Awards: German Design Award 2016, Germany - "Special Mention" & IF Product Design Award 2016, Germany  
 Duty Code: 9401790000  
 Made in: Denmark  
 Construction: Form is delivered assembled. The plastic type is Polypropylene (PP). Armchair armrest height: 65,8 cm  
 Maintenance: Clean with damp cloth.

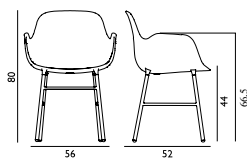

### Form Armchair Steel

Colli: 1  
 Size & Weight: H: 80 x W: 56 x D: 52 x SH: 44 cm - 7 kg  
 Packing: Brown Box - H: 81,5 x L: 54 x D: 54 cm - 8,2 kg  
 Material: Shell: Polypropylene, Legs: Powder Coated Steel.  
 Production time: 2 weeks

	602756 White		602757 Grey		602758 Black		602759 Blue
			602760 Green		602761 Red		

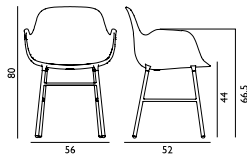

### Form Armchair Chrome

Colli: 1  
 Size & Weight: H: 80 x W: 56 x D: 52 x SH: 44 cm - 7 kg  
 Packing: Brown Box - H: 81,5 x L: 54 x D: 54 cm - 8,2 kg  
 Material: Shell: Polypropylene, Legs: Chrome.  
 Production time: 2 weeks

 603150 White	 603151 Grey	 603152 Black	 603153 Blue
 603154 Green	 603155 Red		

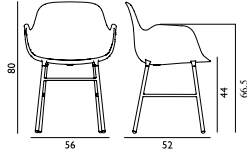

### Form Armchair Brass

Colli: 1  
 Size & Weight: H: 80 x W: 56 x D: 52 x SH: 44 cm - 7 kg  
 Packing: Brown Box - H: 81,5 x L: 54 x D: 54 cm - 8,2 kg  
 Material: Shell: Polypropylene, Legs: Brass Plated Steel.  
 Production time: 2 weeks

 1400912 White	 1400913 Grey	 1400914 Black	 1400915 Blue
 1400916 Green	 1400917 Red		

## FORM ARMCHAIR FULL UPHOLSTERY STEEL

**Design:** Simon Legald, 2014  
**Awards:** German Design Award 2016, Germany - "Special Mention" & IF Product Design Award 2016, Germany  
**Duty Code:** 9401710000  
**Made in:** Poland  
**Construction:** The shell is made of high-quality polypropylene (PP) and has been molded using one single injection, ensuring an extremely strong construction with the finest surface possible. The molded connectors are made from wood. The shell is upholstered with upholstery of your choice. Form is delivered assembled. Armchair armrest height: 65,8 cm  
**Maintenance:** Textile: Clean with textile or upholstery cleaner. Leather: Clean with a damp cloth. Use warm water with soap flakes. Frequent vacuuming with a soft fitting is recommended for both textile and leather to preserve color and appearance.

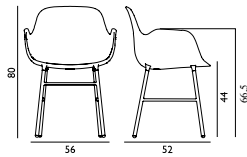

### Form Armchair Full Upholstery Steel

Colli: 1  
 Size & Weight: H: 80 x W: 56 x D: 52 x SH: 44 cm - 8 kg  
 Packing: Brown Box - H: 90 x L: 55,5 x D: 56,5 cm - 11 kg  
 Material: Shell: Polypropylene, PU Foam, Textile: Sørensen Leather/Ultra Leather, JAB/City Velvet, Camira/Main Line Flax, Camira/Synergy, Camira/Aquarius, Camira/Oceanic, Camira/Yoredale. Legs: Powder Coated Steel.  
 Production time: 6 weeks

 1360250 Ultra Leather
 1400864 City Velvet vol 2
 1400976 Main Line flax
 1400977 Synergy
 1401326 Aquarius
 1401327 Oceanic
 1401328 Yoredale

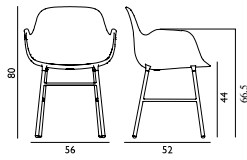

### Form Armchair Full Upholstery Chrome





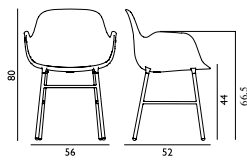

Colli: 1  
 Size & Weight: H: 80 x W: 56 x D: 52 x SH: 44 cm - 8 kg  
 Packing: Brown Box - H: 90 x L: 55,5 x D: 56,5 cm - 11 kg  
 Material: Shell: Polypropylene, PU Foam, Textile: Sorensen Leather/Ultra Leather, JAB/City Velvet, Camira/Main Line Flax, Camira/Synergy, Camira/Aquarius, Camira/Oceanic, Camira/Yoredale. Legs: Chrome.  
 Production time: 6 weeks

	1360256 Ultra Leather
	1400865 City Velvet vol 2
	1400978 Main Line flax
	1400979 Synergy
	1401330 Aquarius
	1401331 Oceanic
	1401332 Yoredale



### Form Armchair Full Upholstery Brass

Size & Weight: H: 80 x W: 56 x D: 52 x SH: 44 cm - 8 kg  
 Packing: Brown Box - H: 90 x L: 55,5 x D: 56,5 cm - 11 kg  
 Material: Shell: Polypropylene, PU Foam, Textile: Sorensen Leather/Ultra Leather, JAB/City Velvet, Camira/Main Line Flax, Camira/Synergy, Camira/Aquarius, Camira/Oceanic, Camira/Yoredale. Legs: Brass Plated Steel.  
 Production time: 6 weeks

	1400866 City Velvet vol 2
	1400923 Ultra Leather
	1400980 Main Line flax
	1400981 Synergy
	1401334 Aquarius
	1401335 Oceanic
	1401336 Yoredale

## FORM CHAIR SWIVEL 4L ALU

Design: Simon Legald, 2016  
 Duty Code: 9401790000  
 Made in: Denmark

Construction: The shell is made of high-quality polypropylene (PP) and has been molded using one single injection, ensuring an extremely strong construction with the finest surface possible. The swivel base grips the chair shell with four slim arms that meet in a rotating centerpiece, which then branch out into four legs. Form is delivered assembled.

Maintenance: Clean with damp cloth.

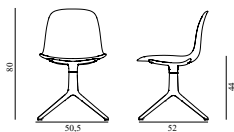

### Form Chair Swivel 4L Alu

Colli: 1  
 Size & Weight: H: 80 x W: 50,5 x D: 52 x SH: 44 cm - 7,6 kg  
 Packing: Brown Box - H: 90 x L: 56 x D: 56 cm  
 Material: Shell: Polypropylene, Legs: Aluminium.  
 Production time: 2 weeks

	606000 White		606001 Grey		606002 Black		606003 Blue
			606004 Green		606005 Red		



### Form Chair Swivel 4L Black Alu

Colli: 1  
 Size & Weight: H: 80 x W: 50,5 x D: 52 x SH: 44 cm - 7,6 kg  
 Packing: Brown Box - H: 90 x L: 56 x D: 56 cm  
 Material: Shell: Polypropylene, Legs: Powder Coated Aluminium.  
 Production time: 2 weeks

 606010 White	 606011 Grey	 606012 Black	 606013 Blue
 606014 Green	 606015 Red		

## FORM CHAIR SWIVEL 4L FULL UPHOLSTERY ALU

Design: Simon Legald, 2016  
 Duty Code: 9401710000  
 Made in: Poland





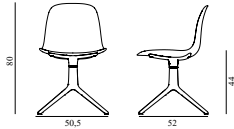

Construction: The shell is made of high-quality polypropylene (PP) and has been molded using one single injection, ensuring an extremely strong construction with the finest surface possible. The swivel base grips the chair shell with four slim arms that meet in a rotating centerpiece, which then branch out into four legs. Form is delivered assembled.

Maintenance: Textile: Clean with textile or upholstery cleaner. Leather: Clean with a damp cloth. Use warm water with soap flakes. Frequent vacuuming with a soft fitting is recommended for both textile and leather to preserve color and appearance.



### Form Chair Swivel 4L Full Upholstery Alu

Colli: 1  
 Size & Weight: H: 80 x W: 50,5 x D: 52 x SH: 44 cm - 8,6 kg  
 Packing: Brown Box - H: 90 x L: 56 x D: 56 cm  
 Material: Shell: Polypropylene, PU Foam, Textile: Sørensen Leather/Ultra Leather, JAB/City Velvet, Camira/Main Line Flax, Camira/Synergy, Camira/Aquarius, Camira/Oceanic, Camira/Yoredale. Legs: Aluminium.  
 Production time: 6 weeks

 1351005 Ultra Leather
 1400858 City Velvet vol 2
 1400964 Main Line flax
 1400965 Synergy
 1401302 Aquarius
 1401303 Oceanic
 1401304 Yoredale





### Form Chair Swivel 4L Full Upholstery Black Alu

Colli: 1  
 Size & Weight: H: 80 x W: 50,5 x D: 52 x SH: 44 cm - 8,6 kg  
 Packing: Brown Box - H: 90 x L: 56 x D: 56 cm  
 Material: Shell: Polypropylene, PU Foam, Textile: Sorensen Leather/ Ultra Leather, JAB/City Velvet, Camira/Main Line Flax, Camira/Synergy, Camira/Aquarius, Camira/Oceanic, Camira/Yoredale.  
 Legs: Powder Coated Aluminum.  
 Production time: 6 weeks

	1351025 Ultra Leather
	1400859 City Velvet vol 2
	1400966 Main Line flax
	1400967 Synergy
	1401306 Aquarius
	1401307 Oceanic
	1401308 Yoredale

## FORM CHAIR SWIVEL 4W

Design: Simon Legald, 2021  
 Awards: German Design Award 2016, Germany - "Special Mention" & IF Product Design Award 2016, Germany  
 Duty Code: 9401790000  
 Made in: Denmark  
 Construction: Polypropylen shell attached with 4 screws to 4L legs Swivel.  
 The chair comes fully assembled.  
 Maintenance: Clean with damp cloth.

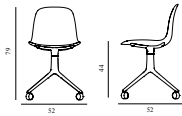

### Form Chair Swivel 4W Alu

Colli: 1  
 Size & Weight: H: 79 x W: 52 x D: 52 x SH: 44 cm - 7,9 kg  
 Packing: Brown Box - H: 83 x L: 54 x D: 58,1 cm - 10,3 kg  
 Material: Shell: Polypropylene. Legs: Swivel base in aluminum with four wheels.  
 Production time: 2 weeks

	604999 White		605000 Grey		605001 Black		605002 Blue
			605003 Green		605004 Red		

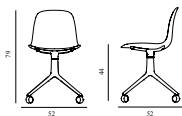

### Form Chair Swivel 4W Black Alu

Colli: 1  
 Size & Weight: H: 79 x W: 52 x D: 52 x SH: 44 cm - 7,9 kg  
 Packing: Brown Box - H: 83 x L: 54 x D: 58,1 cm - 10,3 kg  
 Material: Shell: Polypropylene. Legs: Swivel base in powder coated aluminum with four wheels.  
 Production time: 6 weeks

	605005 White		605006 Grey		605007 Black		605008 Blue
			605009 Green		605010 Red		

# FORM CHAIR SWIVEL 4W FULL UPHOLSTERY

Design: Simon Legald, 2021  
 Awards: German Design Award 2016, Germany - "Special Mention" & IF Product Design Award 2016, Germany  
 Duty Code: 9401710000  
 Made in: Poland  
 Construction: Polypropylen shell attached with 4 screws to 4L legs Swivel.  
 The chair comes fully assembled.  
 Maintenance: Clean with damp cloth.

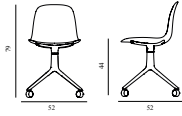



## Form Chair Swivel 4W Full Upholstery Alu

Colli: 1  
 Size & Weight: H: 79 x W: 52 x D: 52 x SH: 44 cm - 7,9 kg  
 Packing: Brown Box - H: 83 x L: 54 x D: 58, l cm - 10,3 kg  
 Material: Shell: Polypropylene with PU Foam and full upholstery, Textile: Sørensens Leather/Ultra Leather, Camira/Main Line Flax, Camira/Synergy, Camira/Aquarius, Camira/Oceanic, Camira/Yoredale. Legs: Swivel base in aluminum with four wheels.  
 Production time: 5 weeks

 605011  
Main Line Flax

 605012  
Synergy

 605013  
Oceanic

 605014  
Yoredale

 605015  
Aquarius

 605017  
Ultra Leather

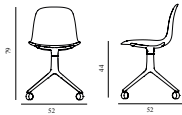

## Form Chair Swivel 4W Full Upholstery Black Alu

Colli: 1  
 Size & Weight: H: 79 x W: 52 x D: 52 x SH: 44 cm - 7,9 kg  
 Packing: Brown Box - H: 83 x L: 54 x D: 58, l cm - 10,3 kg  
 Material: Shell: Polypropylene with PU Foam and full upholstery, Textile: Sørensens Leather/Ultra Leather, Camira/Main Line Flax, Camira/Synergy, Camira/Aquarius, Camira/Oceanic, Camira/Yoredale. Legs: Swivel base in powder coated aluminum with four wheels.  
 Production time: 5 weeks

 605018  
Main Line Flax

 605019  
Synergy

 605020  
Oceanic

 605021  
Yoredale

 605022  
Aquarius

 605024  
Ultra Leather

# FORM CHAIR SWIVEL 5W GAS LIFT ALU

Design: Simon Legald, 2016

Duty Code: 9401390000

Made in: Denmark

Construction: The shell is made of high-quality polypropylene (PP) and has been molded using one single injection, ensuring an extremely strong construction with the finest surface possible. The swivel base grips the chair shell with four slim arms that meet in a rotating centerpiece, which then branch out into five legs with castors. The swivel base comes with a top-quality gas pump. Form is delivered assembled.

Maintenance: Clean with damp cloth.

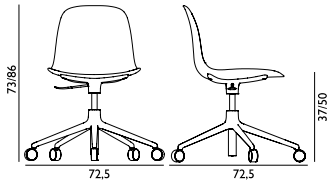

## Form Chair Swivel 5W Gas Lift Alu

Colli: 1  
 Size & Weight: H: 73/86 x L: 72,5 x SH: 37/50 cm - 9 kg  
 Packing: Brown Box - H: 79 x L: 68 x D: 65 cm - 12 kg  
 Material: Shell: Polypropylene, Legs: Aluminium.  
 Production time: 2 weeks

 606040 White	 606041 Grey	 606042 Black	 606043 Blue
		 606044 Green	 606045 Red

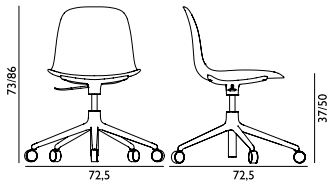

## Form Chair Swivel 5W Gas Lift Black Alu

Colli: 1  
 Size & Weight: H: 73/86 x L: 72,5 x SH: 37/50 cm - 9 kg  
 Packing: Brown Box - H: 79 x L: 68 x D: 65 cm - 12 kg  
 Material: Shell: Polypropylene, Legs: Powder Coated Aluminium.  
 Production time: 2 weeks

 606050 White	 606051 Grey	 606052 Black	 606053 Blue
		 606054 Green	 606055 Red

# FORM CHAIR SWIVEL 5W GAS LIFT FULL UPHOLSTERY ALU

Design: Simon Legald, 2016

Duty Code: 9401390000

Made in: Poland

Construction: The shell is made of high-quality polypropylene (PP) and has been molded using one single injection, ensuring an extremely strong construction with the finest surface possible. The swivel base grips the chair shell with four slim arms that meet in a rotating centerpiece, which then branch out into five legs with castors. The swivel base comes with a top-quality gas pump. Form is delivered assembled.

Maintenance: Textile: Clean with textile or upholstery cleaner. Leather: Clean with a damp cloth. Use warm water with soap flakes. Frequent vacuuming with a soft fitting is recommended for both textile and leather to preserve color and appearance.

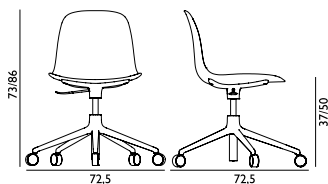

## Form Chair Swivel 5W Gas Lift Full Upholstery Alu

Colli: 1  
 Size & Weight: H: 73/86 x L: 72,5 x SH: 37/50 cm - 9 kg  
 Packing: Brown Box - H: 90 x L: 68 x D: 65 cm - 13 kg  
 Material: Shell: Polypropylene, PU Foam, Textile: Sørensen Leather/Ultra Leather, JAB/City Velvet, Camira/Main Line Flax, Camira/Synergy, Camira/Aquarius, Camira/Oceanic, Camira/Yoredale. Legs: Aluminium.  
 Production time: 6 weeks

 1351105  
Ultra Leather

 1400861  
City Velvet vol 2

 1400970  
Main Line flax

 1400971  
Synergy

 1401314  
Aquarius

 1401315  
Oceanic

 1401316  
Yoredale

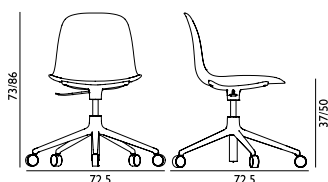

## Form Chair Swivel 5W Gas Lift Full Upholstery Black Alu

Colli: 1  
 Size & Weight: H: 73/86 x L: 72,5 x SH: 37/50 cm - 9 kg  
 Packing: Brown Box - H: 90 x L: 68 x D: 65 cm - 13 kg  
 Material: Shell: Polypropylene, PU Foam, Textile: Sørensen Leather/Ultra Leather, JAB/City Velvet, Camira/Main Line Flax, Camira/Synergy, Camira/Aquarius, Camira/Oceanic, Camira/Yoredale. Legs: Powder Coated Aluminium.  
 Production time: 6 weeks

 1351125  
Ultra Leather

 1400862  
City Velvet vol 2

 1400972  
Main Line flax

 1400973  
Synergy

 1401318  
Aquarius

 1401319  
Oceanic

 1401320  
Yoredale

# FORM ARMCHAIR SWIVEL 4L ALU

Design: Simon Legald, 2016  
 Awards: German Design Award 2016, Germany - "Special Mention" & IF Product Design Award 2016, Germany  
 Duty Code: 9401790000  
 Made in: Denmark  
 Construction: The shell is made of high-quality polypropylene (PP) and has been molded using one single injection, ensuring an extremely strong construction with the finest surface possible. The swivel base grips the chair shell with four slim arms that meet in a rotating centerpiece, which then branch out into four legs. Form is delivered assembled.  
 Maintenance: Clean with damp cloth.

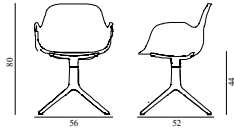

## Form Armchair Swivel 4L Alu

Coll: I  
 Size & Weight: H: 80 x W: 56 x D: 52 x SH: 44 cm - 9 kg  
 Packing: Brown Box - H: 86 x L: 58 x D: 55,5 cm - 11 kg  
 Material: Shell: Polypropylene, Legs: Aluminium.  
 Production time: 2 weeks

 606100 White	 606101 Grey	 606102 Black	 606103 Blue
 606104 Green	 606105 Red		

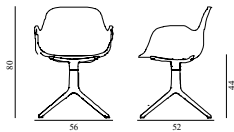

## Form Armchair Swivel 4L Black Alu

Coll: I  
 Size & Weight: H: 80 x W: 56 x D: 52 x SH: 44 cm - 9 kg  
 Packing: Brown Box - H: 86 x L: 58 x D: 55,5 cm - 11 kg  
 Material: Shell: Polypropylene, Legs: Powder Coated Aluminium.  
 Production time: 2 weeks

 606110 White	 606111 Grey	 606112 Black	 606113 Blue
 606114 Green	 606115 Red		

# FORM ARMCHAIR SWIVEL 4L FULL UPHOLSTERY ALU

Design: Simon Legald, 2016  
 Awards: German Design Award 2016, Germany - "Special Mention" & IF Product Design Award 2016, Germany  
 Duty Code: 9401710000  
 Made in: Poland  
 Construction: The shell is made of high-quality polypropylene (PP) and has been molded using one single injection, ensuring an extremely strong construction with the finest surface possible. The swivel base grips the chair shell with four slim arms that meet in a rotating centerpiece, which then branch out into four legs. Form is delivered assembled.  
 Maintenance: Textile: Clean with textile or upholstery cleaner. Leather: Clean with a damp cloth. Use warm water with soap flakes. Frequent vacuuming with a soft fitting is recommended for both textile and leather to preserve color and appearance.

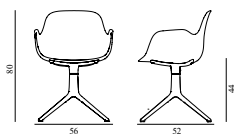

## Form Armchair Swivel 4L Full Uph. Alu

Colli: 1  
 Size & Weight: H: 80 x W: 56 x D: 52 x SH: 44 cm - 10 kg  
 Packing: Brown Box - H: 89,5 x L: 56,5 x D: 55,5 cm - 12 kg  
 Material: Shell: PP, PU Foam, Textile: Sørensens Læder/Ultra Leather, JAB/City Velvet, Camira/Main Line Flax, Camira/Synergy, Camira/Aquarius, Camira/Oceanic, Camira/Yoredale. Legs: Alu.  
 Production time: 6 weeks

 1361005  
Ultra Leather

 1400870  
City Velvet vol 2

 1400988  
Main Line flax

 1400989  
Synergy

 1401350  
Aquarius

 1401351  
Oceanic

 1401352  
Yoredale

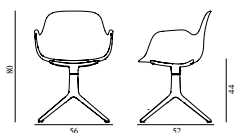



## Form Armchair Swivel 4L Full Uph. Black Alu

Colli: 1  
 Size & Weight: H: 80 x W: 56 x D: 52 x SH: 44 cm - 10 kg  
 Packing: Brown Box - H: 89,5 x L: 56,5 x D: 55,5 cm - 12 kg  
 Material: Shell: Polypropylene, PU Foam, Textile: Sørensens Leather/Ultra Leather, JAB/City Velvet, Camira/Main Line Flax, Camira/Synergy, Camira/Aquarius, Camira/Oceanic, Camira/Yoredale. Legs: Powder Coated Aluminium.  
 Production time: 6 weeks

 1361025  
Ultra Leather

 1400871  
City Velvet vol 2

 1400990  
Main Line flax

 1400991  
Synergy

 1401354  
Aquarius

 1401355  
Oceanic

 1401356  
Yoredale

# FORM ARMCHAIR SWIVEL 4W

Design: Simon Legald, 2021  
 Awards: German Design Award 2016, Germany - "Special Mention" & IF Product Design Award 2016, Germany  
 Duty Code: 9401790000  
 Made in: Denmark  
 Construction: Polypropylen shell attached with 4 screws to 4L legs Swivel.  
 The chair comes fully assembled.  
 Maintenance: Clean with damp cloth.

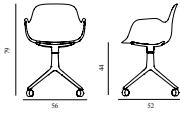

## Form Armchair Swivel 4W Alu

Colli: 1  
 Size & Weight: H: 79 x W: 56 x D: 52 x SH: 44 cm - 8,7 kg  
 Packing: Brown Box - H: 83 x L: 54 x D: 58,1 cm - 10,3 kg  
 Material: Shell: Polypropylene. Legs: Swivel base in aluminum with four wheels.  
 Production time: 6 weeks

 604973 White	 604974 Grey	 604975 Black	 604976 Blue
		 604977 Green	 604978 Red

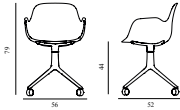

## Form Armchair Swivel 4W Black Alu





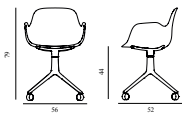

Colli: 1  
 Size & Weight: H: 79 x W: 56 x D: 52 x SH: 44 cm - 8,7 kg  
 Packing: Brown Box - H: 83 x L: 54 x D: 58,1 cm - 10,3 kg  
 Material: Shell: Polypropylene. Legs: Swivel base in powder coated aluminum with four wheels.  
 Production time: 6 weeks

 604979 White	 604980 Grey	 604981 Black	 604982 Blue
		 604983 Green	 604984 Red





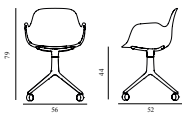

# FORM ARMCHAIR SWIVEL 4W FULL UPHOLSTERY

Design: Simon Legald, 2021  
 Awards: German Design Award 2016, Germany - "Special Mention" & IF Product Design Award 2016, Germany  
 Duty Code: 9401710000  
 Made in: Poland  
 Construction: Polypropylen shell attached with 4 screws to 4L legs Swivel.  
 The chair comes fully assembled.  
 Maintenance: Clean with damp cloth.



<b>Form Armchair Swivel 4W Full Upholstery Alu</b>	
Colli:	1
Size & Weight:	H: 79 x W: 56 x D: 52 x SH: 44 cm - 8,7 kg
Packing:	Brown Box - H: 83 x L: 54 x D: 58, l cm - 10,3 kg
Material:	Shell: Polypropylene with PU Foam and full upholstery. Textile: Sørensens Leather/Ultra Leather, Camira/Main Line Flax, Camira/Synergy, Camira/Aquarius, Camira/Oceanic, Camira/Yoredale. Legs: Swivel base in aluminum with four wheels.
Production time: 6 weeks	
	604985 Main Line Flax
	604986 Synergy
	604987 Oceanic
	604988 Yoredale
	604989 Aquarius
	604991 Ultra Leather



<b>Form Armchair Swivel 4W Full Upholstery Black Alu</b>	
Colli:	1
Size & Weight:	H: 79 x W: 56 x D: 52 x SH: 44 cm - 8,7 kg
Packing:	Brown Box - H: 83 x L: 54 x D: 58, l cm - 10,3 kg
Material:	Shell: Polypropylene with PU Foam and full upholstery. Textile: Sørensens Leather/Ultra Leather, Camira/Main Line Flax, Camira/Synergy, Camira/Aquarius, Camira/Oceanic, Camira/Yoredale. Legs: Swivel base in powder coated aluminum with four wheels.
Production time: 6 weeks	
	604992 Main Line Flax
	604993 Synergy
	604994 Oceanic
	604995 Yoredale
	604996 Aquarius
	604998 Ultra Leather



# FORM ARMCHAIR SWIVEL 5W GAS LIFT ALU

Design: Simon Legald, 2016  
 Awards: German Design Award 2016, Germany - "Special Mention" & IF Product Design Award 2016, Germany  
 Duty Code: 9401390000  
 Made in: Denmark  
 Construction: The shell is made of high-quality polypropylene (PP) and has been molded using one single injection, ensuring an extremely strong construction with the finest surface possible. The swivel base grips the chair shell with four slim arms that meet in a rotating centerpiece, which then branch out into five legs with castors. The swivel base comes with a top-quality gas pump. Form is delivered assembled.  
 Maintenance: Clean with damp cloth.

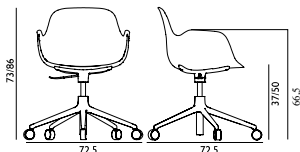

## Form Armchair Swivel 5W Gas Lift Alu

Colli: 1  
 Size & Weight: H: 73/86 x L: 72,5 x SH: 37/50 cm - 10 kg  
 Packing: Brown Box - H: 81 x L: 66,5 x D: 68,5 cm - 13 kg  
 Material: Shell: Polypropylene, Legs: Aluminium.  
 Production time: 2 weeks

 606140 White	 606141 Grey	 606142 Black	 606143 Blue
		 606144 Green	 606145 Red

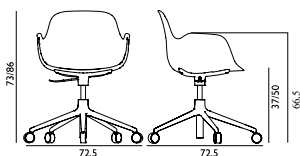

## Form Armchair Swivel 5W Gas Lift Black Alu

Colli: 1  
 Size & Weight: H: 73/86 x L: 72,5 x SH: 37/50 cm - 10 kg  
 Packing: Brown Box - H: 81 x L: 66,5 x D: 68,5 cm - 13 kg  
 Material: Shell: Polypropylene, Legs: Powder Coated Aluminium.  
 Production time: 2 weeks

 606150 White	 606151 Grey	 606152 Black	 606153 Blue
		 606154 Green	 606155 Red

# FORM ARMCHAIR SWIVEL 5W GAS LIFT FULL UPHOLSTERY ALU

Design: Simon Legald, 2016  
 Awards: German Design Award 2016, Germany - "Special Mention" & IF Product Design Award 2016, Germany  
 Duty Code: 9401390000  
 Made in: Poland  
 Construction: The shell is made of high-quality polypropylene (PP) and has been molded using one single injection, ensuring an extremely strong construction with the finest surface possible. The swivel base grips the chair shell with four slim arms that meet in a rotating centerpiece, which then branch out into five legs with castors. The swivel base comes with a top-quality gas pump. Form is delivered assembled.  
 Maintenance: Textile: Clean with textile or upholstery cleaner. Leather: Clean with a damp cloth. Use warm water with soap flakes. Frequent vacuuming with a soft fitting is recommended for both textile and leather to preserve color and appearance.

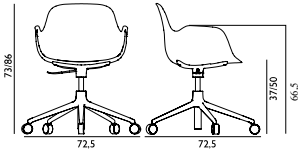

## Form Armchair Swivel 5W Gas Lift Full Uph. Alu

Colli: 1  
 Size & Weight: H: 73/86 x L: 72,5 x SH: 37/50 cm - 10 kg  
 Packing: Brown Box - H: 81 x L: 66,5 x D: 68,5 cm - 14 kg  
 Material: Shell: Polypropylene, PU Foam, Textile: Sørensens Leather/Ultra Leather, JAB/City Velvet, Camira/Main Line Flax, Camira/Synergy, Camira/Aquarius, Camira/Oceanic, Camira/Yoredale. Legs: Aluminium.

Production time: 6 weeks

 1361105  
Ultra Leather

 1400873  
City Velvet vol 2

 1400994  
Main Line flax

 1400995  
Synergy

 1401362  
Aquarius

 1401363  
Oceanic

 1401364  
Yoredale

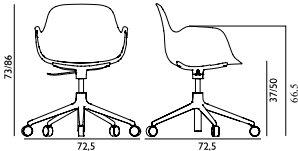

## Form Armchair Swivel 5W Gas Lift Full Uph. Black Alu

Colli: 1  
 Size & Weight: H: 73/86 x L: 72,5 x SH: 37/50 cm - 10 kg  
 Packing: Brown Box - H: 81 x L: 66,5 x D: 68,5 cm - 14 kg  
 Material: Shell: Polypropylene, PU Foam, Textile: Sørensens Leather/Ultra Leather, JAB/City Velvet, Camira/Main Line Flax, Camira/Synergy, Camira/Aquarius, Camira/Oceanic, Camira/Yoredale. Legs: Powder Coated Aluminium.

Production time: 6 weeks

 1361125  
Ultra Leather

 1400874  
City Velvet vol 2

 1400996  
Main Line flax

 1400997  
Synergy

 1401366  
Aquarius

 1401367  
Oceanic

 1401368  
Yoredale

# FORM BARSTOOL 65 CM WOOD

Design: Simon Legald, 2016  
 Awards: German Design Award 2016, Germany - "Special Mention" & IF Product Design Award 2016, Germany  
 Duty Code: 9401790000  
 Made in: Denmark  
 Construction: The shell is made of high-quality polypropylene (PP) and has been molded using one single injection, ensuring an extremely strong construction with the finest surface possible. The molded connectors match the legs in color, creating a seamless transition from legs to shell. Form is delivered assembled.  
 Maintenance: Clean with damp cloth.

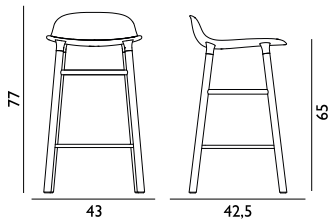

## Form Barstool 65 cm Black Oak

Coll: I  
 Size & Weight: H: 77 x W: 43 x D: 42,5 x SH: 65 cm - 3,4 kg  
 Packing: Brown Box - H: 82 x L: 45,2 x D: 45,2 cm - 4,6 kg  
 Material: Shell: Polypropylene, Legs: Painted and Lacquered Oak.  
 Production time: 2 weeks

 603212 White	 603213 Grey	 603214 Black	 603215 Blue
 603216 Green	 603217 Red		

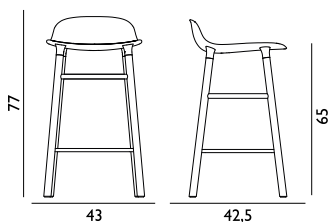

## Form Barstool 65 cm Oak

Coll: I  
 Size & Weight: H: 77 x W: 43 x D: 42,5 x SH: 65 cm - 3,4 kg  
 Packing: Brown Box - H: 82 x L: 45,2 x D: 45,2 cm - 4,6 kg  
 Material: Shell: Polypropylene, Legs: Oak.  
 Production time: 2 weeks

 602780 White	 602781 Grey	 602782 Black	 602783 Blue
 602784 Green	 602785 Red		

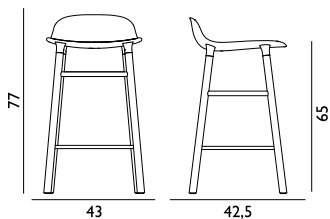

## Form Barstool 65 cm Walnut

Coll: I  
 Size & Weight: H: 77 x W: 43 x D: 42,5 x SH: 65 cm - 3,4 kg  
 Packing: Brown Box - H: 82 x L: 45,2 x D: 45,2 cm - 4,6 kg  
 Material: Shell: Polypropylene, Legs: Walnut.  
 Production time: 2 weeks

 602786 White	 602787 Grey	 602788 Black	 602789 Blue
 602790 Green	 602791 Red		

# FORM BARSTOOL 65 CM FULL UPHOLSTERY WOOD

Design: Simon Legald, 2016  
 Awards: German Design Award 2016, Germany - "Special Mention" & IF Product Design Award 2016, Germany  
 Duty Code: 9401610000  
 Made in: Poland  
 Construction: Form is delivered assembled. The molded connectors match the legs in color, creating a seamless transition from legs to shell.  
 Maintenance: Textile: Clean with textile or upholstery cleaner. Leather: Clean with a damp cloth. Use warm water with soap flakes. Frequent vacuuming with a soft fitting is recommended for both textile and leather to preserve color and appearance.

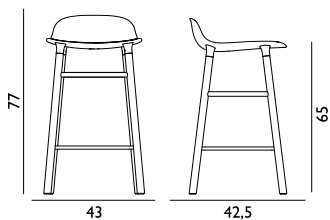

## Form Barstool 65 cm Full Upholstery Black Oak

Colli: 1  
 Size & Weight: H: 77 x W: 43 x D: 42,5 x SH: 65 cm - 4 kg  
 Packing: Brown Box - H: 92,5 x L: 48,5 x D: 49 cm - 7 kg  
 Material: Shell: Polypropylene, PU Foam, Textile: Sørensen Leather/Ultra Leather, JAB/City Velvet, Camira/Main Line Flax, Camira/Synergy, Camira/Aquarius, Camira/Oceanic, Camira/Yoredale. Legs: Painted and Lacquered Oak.

Production time: 6 weeks



1380362  
Ultra Leather

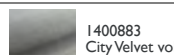

1400883  
City Velvet vol 2



1401214  
Main Line flax

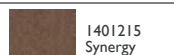

1401215  
Synergy

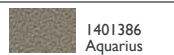

1401386  
Aquarius

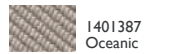

1401387  
Oceanic



1401388  
Yoredale

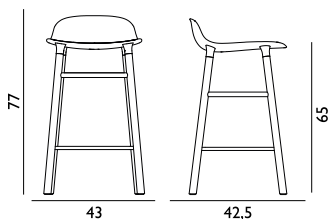

## Form Barstool 65 cm Full Upholstery Oak

Colli: 1  
 Size & Weight: H: 77 x W: 43 x D: 42,5 x SH: 65 cm - 4 kg  
 Packing: Brown Box - H: 92,5 x L: 48,5 x D: 49 cm - 7 kg  
 Material: Shell: Polypropylene, PU Foam, Textile: Sørensen Leather/Ultra Leather, JAB/City Velvet, Camira/Main Line Flax, Camira/Synergy, Camira/Aquarius, Camira/Oceanic, Camira/Yoredale. Legs: Oak.

Production time: 6 weeks



1380650  
Ultra Leather

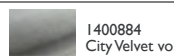

1400884  
City Velvet vol 2



1401216  
Main Line flax

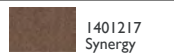

1401217  
Synergy

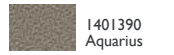

1401390  
Aquarius

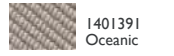

1401391  
Oceanic

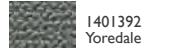

1401392  
Yoredale

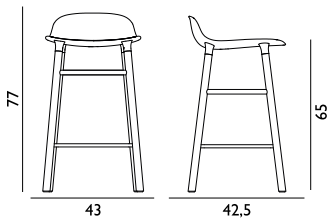

### Form Barstool 65 cm Full Upholstery Walnut

Colli: 1  
 Size & Weight: H: 77 x W: 43 x D: 42,5 x SH: 65 cm - 4 kg  
 Packing: Brown Box - H: 92,5 x L: 48,5 x D: 49 cm - 7 kg  
 Material: Shell: Polypropylene, PU Foam, Textile: Sorensen Leather/ Ultra Leather, JAB/City Velvet, Camira/Main Line Flax, Camira/Synergy, Camira/Aquarius, Camira/Oceanic, Camira/Yoredale. Legs: Walnut.  
 Production time: 6 weeks

	1380950 Ultra Leather
	1400885 City Velvet vol 2
	1401218 Main Line flax
	1401219 Synergy
	1401394 Aquarius
	1401395 Oceanic
	1401396 Yoredale

## FORM BARSTOOL 65 CM STEEL

Design: Simon Legald, 2014  
 Awards: German Design Award 2016, Germany - "Special Mention" & IF Product Design Award 2016, Germany  
 Duty Code: 9401790000  
 Made in: Denmark  
 Construction: The shell is made of high-quality polypropylene (PP) and has been molded using one single injection, ensuring an extremely strong construction with the finest surface possible. The molded connectors match the legs in color, creating a seamless transition from legs to shell. Form is delivered assembled.  
 Maintenance: Clean with damp cloth.

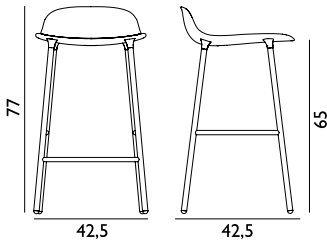

### Form Barstool 65 cm Steel

Colli: 1  
 Size & Weight: H: 77 x W: 42,5 x D: 42,5 x SH: 65 cm - 4,2 kg  
 Packing: Brown Box - H: 80 x L: 44,5 x D: 44,5 cm - 6,4 kg  
 Material: Shell: Polypropylene, Legs: Powder Coated Steel.  
 Production time: 2 weeks

	602774 White		602775 Grey		602776 Black		602777 Blue
			602778 Green		602779 Red		

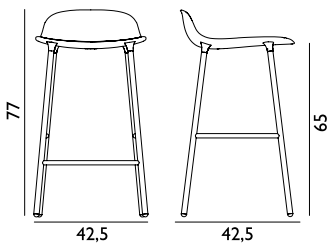

### Form Barstool 65 cm Chrome

Colli: 1  
 Size & Weight: H: 77 x W: 42,5 x D: 42,5 x SH: 65 cm - 4,2 kg  
 Packing: Brown Box - H: 82 x L: 45,2 x D: 45,2 cm - 6,4 kg  
 Material: Shell: Polypropylene, Legs: Chrome.  
 Production time: 2 weeks

	603156 White		603157 Grey		603158 Black		603159 Blue
			603160 Green		603161 Red		

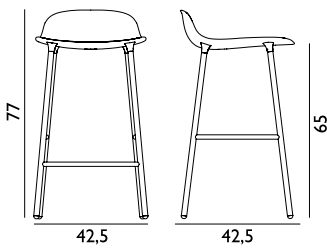

### Form Barstool 65 cm Brass

Colli: 1  
 Size & Weight: H: 77 x W: 42,5 x D: 42,5 x SH: 65 cm - 4,2 kg  
 Packing: Brown Box - H: 80 x L: 44,5 x D: 44,5 cm - 6,4 kg  
 Material: Shell: Polypropylene, Legs: Brass plated steel.  
 Production time: 2 weeks

 1400924 White	 1400925 Grey	 1400926 Black	 1400927 Blue
 1400928 Green	 1400929 Red		

## FORM BARSTOOL 65 CM FULL UPHOLSTERY STEEL

Design: Simon Legald, 2015  
 Awards: German Design Award 2016, Germany - "Special Mention" & IF Product Design Award 2016, Germany  
 Duty Code: 9401710000  
 Made in: Poland  
 Construction: Form is delivered assembled. The molded connectors match the legs in color, creating a seamless transition from legs to shell.  
 Maintenance: Textile: Clean with textile or upholstery cleaner. Leather: Clean with a damp cloth. Use warm water with soap flakes. Frequent vacuuming with a soft fitting is recommended for both textile and leather to preserve color and appearance.

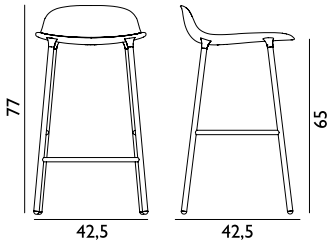

### Form Barstool 65 cm Full Upholstery Steel

Colli: 1  
 Size & Weight: H: 77 x W: 42,5 x D: 42,5 x SH: 65 cm - 4,5 kg  
 Packing: Brown Box - H: 92,5 x L: 48,5 x D: 49 cm - 7 kg  
 Material: Shell: Polypropylene, PU Foam, Textile: Sorensen Leather/Ultra Leather, JAB/City Velvet, Camira/Main Line Flax, Camira/Synergy, Camira/Aquarius, Camira/Oceanic, Camira/Yoredale. Legs: Powder Coated Steel.  
 Production time: 6 weeks

 1380350 Ultra Leather
 1400880 City Velvet vol 2
 1401208 Main Line flax
 1401209 Synergy
 1401374 Aquarius
 1401375 Oceanic
 1401376 Yoredale

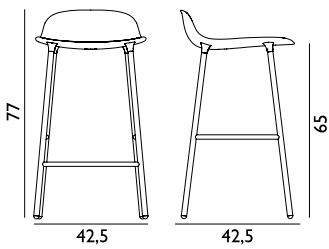

### Form Barstool 65 cm Full Upholstery Chrome

Colli: 1  
 Size & Weight: H: 77 x W: 42,5 x D: 42,5 x SH: 65 cm - 4,5 kg  
 Packing: Brown Box - H: 92,5 x L: 48,5 x D: 49 cm - 7 kg  
 Material: Shell: Polypropylene, PU Foam, Textile: Sorensen Leather/Ultra Leather, JAB/City Velvet, Camira/Main Line Flax, Camira/Synergy, Camira/Aquarius, Camira/Oceanic, Camira/Yoredale. Legs: Chrome.  
 Production time: 6 weeks

	I380356 Ultra Leather
	I400881 City Velvet vol 2
	I401210 Main Line flax
	I401211 Synergy
	I401378 Aquarius
	I401379 Oceanic
	I401380 Yoredale

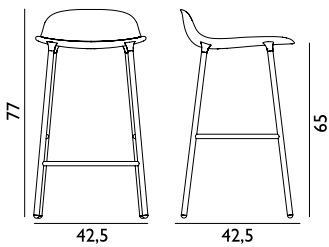

### Form Barstool 65 cm Full Upholstery Brass

Size & Weight: H: 77 x W: 42,5 x D: 42,5 x SH: 65 cm - 4,5 kg  
 Packing: Brown Box - H: 92,5 x L: 48,5 x D: 49 cm - 7 kg  
 Material: Shell: Polypropylene, PU Foam, Textile: Sorensen Leather/Ultra Leather, JAB/City Velvet, Camira/Main Line Flax, Camira/Synergy, Camira/Aquarius, Camira/Oceanic, Camira/Yoredale. Legs: Brass plated steel.  
 Production time: 6 weeks

	I400882 City Velvet vol 2
	I400935 Ultra Leather
	I401212 Main Line flax
	I401213 Synergy
	I401382 Aquarius
	I401383 Oceanic
	I401384 Yoredale

## FORM BAR CHAIR 65 CM STEEL

Design: Simon Legald, 2014  
 Awards: German Design Award 2016, Germany - "Special Mention" & IF Product Design Award 2016, Germany  
 Duty Code: 9401790000  
 Made in: Denmark  
 Construction: The shell is made of high-quality polypropylene (PP) and has been molded using one single injection, ensuring an extremely strong construction with the finest surface possible. Form is delivered assembled.  
 Maintenance: Clean with damp cloth.

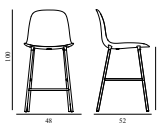

### Form Bar Chair 65 cm Steel

Colli: 1  
 Size & Weight: H: 100 x W: 48 x D: 52 x SH: 65 cm - 5,6 kg  
 Packing: Brown Box - H: 100 x L: 50 x D: 52,5 cm - 7,9 kg  
 Material: Shell: Polypropylene, Legs: Powder coated steel  
 Production time: 2 weeks

	I402006 White		I402007 Grey		I402008 Black		I402009 Blue
	I402010 Green		I402011 Red				

## FORM BAR CHAIR 65 CM FULL UPHOLSTERY STEEL

Design: Simon Legald, 2015  
 Awards: German Design Award 2016, Germany - "Special Mention" & IF Product Design Award 2016, Germany

Duty Code: 9401710000

Made in: Poland

Construction: The shell is made of high-quality polypropylene (PP) and has been molded using one single injection, ensuring an extremely strong construction with the finest surface possible. Form is delivered assembled.

Maintenance: Textile: Clean with textile or upholstery cleaner. Leather: Clean with a damp cloth. Use warm water with soap flakes. Frequent vacuuming with a soft fitting is recommended for both textile and leather to preserve color and appearance.

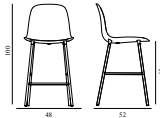

### Form Bar Chair 65 cm Full Upholstery Steel

Colli: 1  
 Size & Weight: H: 100 x W: 56 x D: 52 x SH: 65 cm - 5,6 kg  
 Packing: Brown Box - H: 100 x L: 50 x D: 52,5 cm - 7,9 kg  
 Material: Shell: Polypropylene (PP), PU Foam, Textile: Sørensen Leather/ Ultra Leather, JAB/City Velvet, Camira/Main Line Flax, Camira/Synergy, Camira/Aquarius, Camira/Oceanic, Camira/Yoredale. Legs: Lacquered steel.  
 Production time: 6 weeks

 1402045  
Ultra Leather

 1402046  
Main Line Flax

 1402047  
Synergy

 1402048  
Aquarius

 1402049  
Oceanic

 1402050  
Yoredale

## FORM BAR ARMCHAIR 65 CM STEEL

Design: Simon Legald, 2014  
 Awards: German Design Award 2016, Germany - "Special Mention" & IF Product Design Award 2016, Germany

Duty Code: 9401790000

Made in: Denmark

Construction: The shell is made of high-quality polypropylene (PP) and has been molded using one single injection, ensuring an extremely strong construction with the finest surface possible. Form is delivered assembled.

Maintenance: Clean with damp cloth.

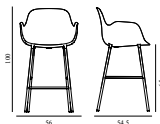

### Form Bar Armchair 65 cm Steel

Colli: 1  
 Size & Weight: H: 100 x W: 56 x D: 54,5 x SH: 65 cm - 6,4 kg  
 Packing: Brown Box - H: 100 x L: 52,5 x D: 58 cm - 8,4 kg  
 Material: Shell: Polypropylene, Legs: Powder coated steel  
 Production time: 2 weeks

 1402018  
White

 1402019  
Grey

 1402020  
Black

 1402021  
Blue

 1402022  
Green

 1402023  
Red



# FORM BAR ARMCHAIR 65 CM FULL UPHOLSTERY STEEL

Design: Simon Legald, 2015  
 Awards: German Design Award 2016, Germany - "Special Mention" & IF Product Design Award 2016, Germany  
 Duty Code: 9401710000  
 Made in: Poland  
 Construction: The shell is made of high-quality polypropylene (PP) and has been molded using one single injection, ensuring an extremely strong construction with the finest surface possible. Form is delivered assembled.  
 Maintenance: Textile: Clean with textile or upholstery cleaner. Leather: Clean with a damp cloth. Use warm water with soap flakes. Frequent vacuuming with a soft fitting is recommended for both textile and leather to preserve color and appearance.

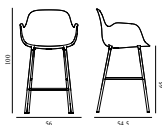

## Form Bar Armchair 65 cm Full Upholstery Steel

Colli: 1  
 Size & Weight: H: 100 x W: 56 x D: 54,5 x SH: 65 cm - 6,4 kg  
 Packing: Brown Box - H: 100 x L: 52,5 x D: 58 cm - 8,7 kg  
 Material: Shell: Polypropylene (PP), PU Foam, Textile: Sorensen Leather/Ultra Leather, JAB/City Velvet, Camira/Main Line Flax, Camira/Synergy, Camira/Aquarius, Camira/Oceanic, Camira/Yoredale. Legs: Lacquered steel.  
 Production time: 6 weeks

	1402087 Ultra Leather
	1402088 Main Line Flax
	1402089 Synergy
	1402090 Aquarius
	1402091 Oceanic
	1402092 Yoredale

# FORM BARSTOOL 75 CM WOOD

Design: Simon Legald, 2016  
 Awards: German Design Award 2016, Germany - "Special Mention" & IF Product Design Award 2016, Germany  
 Duty Code: 9401790000  
 Made in: Denmark  
 Construction: The shell is made of high-quality polypropylene (PP) and has been molded using one single injection, ensuring an extremely strong construction with the finest surface possible. The molded connectors match the legs in color, creating a seamless transition from legs to shell. Form is delivered assembled.  
 Maintenance: Clean with damp cloth.

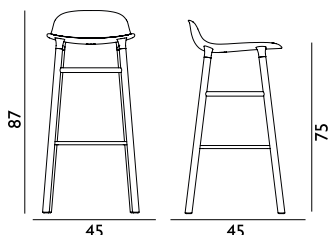

## Form Barstool 75 cm Black Oak

Colli: 1  
 Size & Weight: H: 87 x W: 45 x D: 45 x SH: 75 cm - 3,5 kg  
 Packing: Brown Box - H: 92 x L: 46,5 x D: 47 cm - 4,7 kg  
 Material: Shell: Polypropylene, Legs: Painted and Lacquered Oak.  
 Production time: 2 weeks

	603218 White		603219 Grey		603220 Black		603221 Blue
	603222 Green		603223 Red				

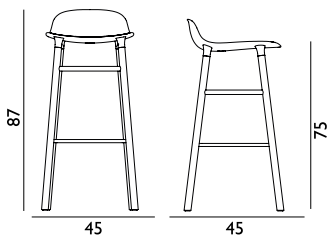

### Form Barstool 75 cm Oak

Colli: 1  
 Size & Weight: H: 87 x W: 45 x D: 45 x SH: 75 cm - 3,5 kg  
 Packing: Brown Box - H: 92 x L: 46,5 x D: 47 cm - 4,7 kg  
 Material: Shell: Polypropylene, Legs: Oak.  
 Production time: 2 weeks

 602798 White	 602799 Grey	 602800 Black	 602801 Blue
		 602802 Green	 602803 Red

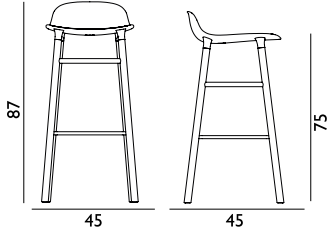

### Form Barstool 75 cm Walnut

Colli: 1  
 Size & Weight: H: 87 x W: 45 x D: 45 x SH: 75 cm - 3,5 kg  
 Packing: Brown Box - H: 92 x L: 46,5 x D: 47 cm - 4,7 kg  
 Material: Shell: Polypropylene, Legs: Walnut.  
 Production time: 2 weeks

 602804 White	 602805 Grey	 602806 Black	 602807 Blue
		 602808 Green	 602809 Red





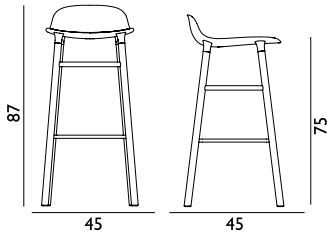

## FORM BARSTOOL 75 CM FULL UPHOLSTERY WOOD

Design: Simon Legald, 2016  
 Awards: German Design Award 2016, Germany - "Special Mention" & IF Product Design Award 2016, Germany  
 Duty Code: 9401610000  
 Made in: Poland  
 Construction: Form is delivered assembled. The molded connectors match the legs in color, creating a seamless transition from legs to shell.  
 Maintenance: Textile: Clean with textile or upholstery cleaner. Leather: Clean with a damp cloth. Use warm water with soap flakes. Frequent vacuuming with a soft fitting is recommended for both textile and leather to preserve color and appearance.



### Form Barstool 75 cm Full Upholstery Black Oak

Colli: 1  
 Size & Weight: H: 87 x W: 45 x D: 45 x SH: 75 cm - 4,1 kg  
 Packing: Brown Box - H: 94,5 x L: 49,5 x D: 48,5 cm - 5,3 kg  
 Material: Shell: Polypropylene, PU Foam, Textile: Sørensens Leather/Ultra Leather, JAB/City Velvet, Camira/Main Line Flax, Camira/Synergy, Camira/Aquarius, Camira/Oceanic, Camira/Yoredale. Legs: Painted and Lacquered Oak.  
 Production time: 6 weeks

 1385362 Ultra Leather
 1400891 City Velvet vol 2
 1401230 Main Line flax
 1401231 Synergy
 1401418 Aquarius
 1401419 Oceanic
 1401420 Yoredale

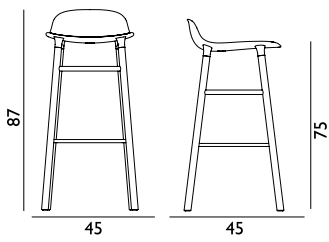

### Form Barstool 75 cm Full Upholstery Oak

Colli: 1  
 Size & Weight: H: 87 x W: 45 x D: 45 x SH: 75 cm - 4,1 kg  
 Packing: Brown Box - H: 94,5 x L: 49,5 x D: 48,5 cm - 5,3 kg  
 Material: Shell: Polypropylene, PU Foam, Textile: Sorensen Leather/Ultra Leather, JAB/City Velvet, Camira/Main Line Flax, Camira/Synergy, Camira/Aquarius, Camira/Oceanic, Camira/Yoredale. Legs: Oak.  
 Production time: 6 weeks

	1385650 Ultra Leather
	1400892 City Velvet vol 2
	1401232 Main Line flax
	1401233 Synergy
	1401422 Aquarius
	1401423 Oceanic
	1401424 Yoredale

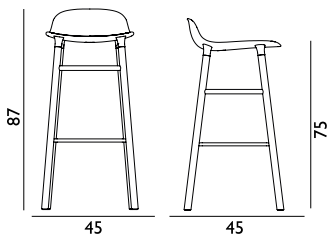

### Form Barstool 75 cm Full Upholstery Walnut

Colli: 1  
 Size & Weight: H: 87 x W: 45 x D: 45 x SH: 75 cm - 4,1 kg  
 Packing: Brown Box - H: 94,5 x L: 49,5 x D: 48,5 cm - 5,3 kg  
 Material: Shell: Polypropylene, PU Foam, Textile: Sorensen Leather/Ultra Leather, JAB/City Velvet, Camira/Main Line Flax, Camira/Synergy, Camira/Aquarius, Camira/Oceanic, Camira/Yoredale. Legs: Walnut.  
 Production time: 6 weeks

	1385950 Ultra Leather
	1400893 City Velvet vol 2
	1401234 Main Line flax
	1401235 Synergy
	1401426 Aquarius
	1401427 Oceanic
	1401428 Yoredale

# FORM BARSTOOL 75 CM STEEL

Design: Simon Legald, 2014  
 Awards: German Design Award 2016, Germany - "Special Mention" & IF Product Design Award 2016, Germany  
 Duty Code: 9401790000  
 Made in: Denmark  
 Construction: The shell is made of high-quality polypropylene (PP) and has been molded using one single injection, ensuring an extremely strong construction with the finest surface possible. The molded connectors match the legs in color, creating a seamless transition from legs to shell. Form is delivered assembled.  
 Maintenance: Clean with damp cloth.

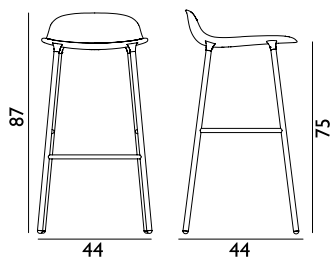

## Form Barstool 75 cm Steel

Coll: I  
 Size & Weight: H: 87 x W: 44 x D: 44 x SH: 75 cm - 4,4 kg  
 Packing: Brown Box - H: 92 x L: 46,5 x D: 47 cm - 6,7 kg  
 Material: Shell: Polypropylene, Legs: Powder Coated Steel.  
 Production time: 2 weeks

 602792 White	 602793 Grey	 602794 Black	 602795 Blue
 602796 Green	 602797 Red		

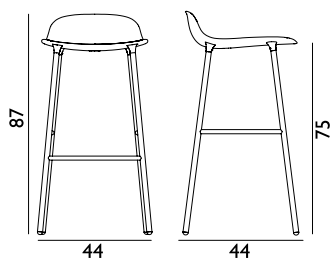

## Form Barstool 75 cm Chrome

Coll: I  
 Size & Weight: H: 87 x W: 44 x D: 44 x SH: 75 cm - 4,4 kg  
 Packing: Brown Box - H: 92 x L: 46,5 x D: 47 cm - 6,7 kg  
 Material: Shell: Polypropylene, Legs: Chrome.  
 Production time: 2 weeks

 603162 White	 603163 Grey	 603164 Black	 603165 Blue
 603166 Green	 603167 Red		

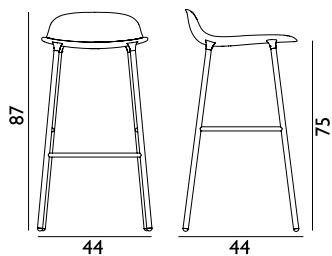

## Form Barstool 75 cm Brass

Coll: I  
 Size & Weight: H: 87 x W: 44 x D: 44 x SH: 75 cm - 4,4 kg  
 Packing: Brown Box - H: 92 x L: 46,5 x D: 47 cm - 6,7 kg  
 Material: Shell: Polypropylene, Legs: Brass plated steel.  
 Production time: 2 weeks

 1400936 White	 1400937 Grey	 1400938 Black	 1400939 Blue
 1400940 Green	 1400941 Red		

# FORM BARSTOOL 75 CM FULL UPHOLSTERY STEEL

Design: Simon Legald, 2015  
 Awards: German Design Award 2016, Germany - "Special Mention" & IF Product Design Award 2016, Germany  
 Duty Code: 9401710000  
 Made in: Poland  
 Construction: Form is delivered assembled. The molded connectors match the legs in color, creating a seamless transition from legs to shell.  
 Maintenance: Textile: Clean with textile or upholstery cleaner. Leather: Clean with a damp cloth. Use warm water with soap flakes. Frequent vacuuming with a soft fitting is recommended for both textile and leather to preserve color and appearance.

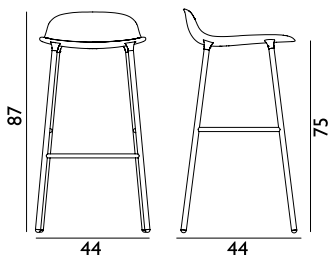

## Form Barstool 75 cm Full Upholstery Steel

Colli: 1  
 Size & Weight: H: 87 x W: 44 x D: 44 x SH: 75 cm - 5 kg  
 Packing: Brown Box - H: 94,5 x L: 49,5 x D: 48,5 cm - 5 kg  
 Material: Shell: Polypropylene, PU Foam, Textile: Sørensen Leather/Ultra Leather, JAB/City Velvet, Camira/Main Line Flax, Camira/Synergy, Camira/Aquarius, Camira/Oceanic, Camira/Yoredale. Legs: Powder Coated Steel.  
 Color: Legs: black, white, grey, blue, green, red  
 Production time: 6 weeks

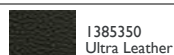

1385350  
Ultra Leather

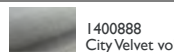

1400888  
City Velvet vol 2

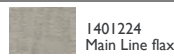

1401224  
Main Line flax

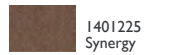

1401225  
Synergy

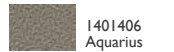

1401406  
Aquarius

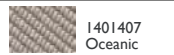

1401407  
Oceanic

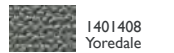

1401408  
Yoredale

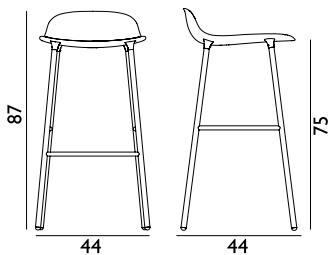

## Form Barstool 75 cm Full Upholstery Chrome

Colli: 1  
 Size & Weight: H: 87 x W: 44 x D: 44 x SH: 75 cm - 5 kg  
 Packing: Brown Box - H: 94,5 x L: 49,5 x D: 48,5 cm - 5 kg  
 Material: Shell: Polypropylene, PU Foam, Textile: Sørensen Leather/Ultra Leather, JAB/City Velvet, Camira/Main Line Flax, Camira/Synergy, Camira/Aquarius, Camira/Oceanic, Camira/Yoredale. Legs: Chrome.  
 Production time: 6 weeks

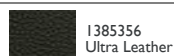

1385356  
Ultra Leather

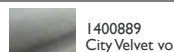

1400889  
City Velvet vol 2



1401226  
Main Line flax

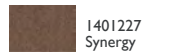

1401227  
Synergy

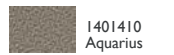

1401410  
Aquarius

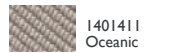

1401411  
Oceanic

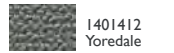



1401412  
Yoredale



### Form Barstool 75 cm Full Upholstery Brass

Size & Weight: H: 87 x W: 44 x D: 44 x SH: 75 cm - 5 kg  
 Packing: Brown Box - H: 94,5 x L: 49,5 x D: 48,5 cm - 5 kg  
 Material: Shell: Polypropylene, PU Foam, Textile: Sorensen Leather/Ultra Leather, JAB/City Velvet, Camira/Main Line Flax, Camira/Synergy, Camira/Aquarius, Camira/Oceanic, Camira/Yoredale. Legs: Brass plated steel.  
 Production time: 6 weeks

	I400890 City Velvet vol 2
	I400947 Ultra Leather
	I401228 Main Line flax
	I401229 Synergy
	I401414 Aquarius
	I401415 Oceanic
	I401416 Yoredale

## FORM BAR CHAIR 75 CM STEEL

Design: Simon Legald, 2014  
 Awards: German Design Award 2016, Germany - "Special Mention" & IF Product Design Award 2016, Germany  
 Duty Code: 9401790000  
 Made in: Denmark  
 Construction: The shell is made of high-quality polypropylene (PP) and has been molded using one single injection, ensuring an extremely strong construction with the finest surface possible. Comes with and without armrest in two different heights. Form is delivered assembled.  
 Maintenance: Clean with damp cloth.



### Form Bar Chair 75 cm Steel

Colli: 1  
 Size & Weight: H: 110 x W: 49 x D: 54,5 x SH: 75 cm - 5,9 kg  
 Packing: Brown Box - H: 110 x L: 51 x D: 56,5 cm - 7,9 kg  
 Material: Shell: Polypropylene, Legs: Powder coated steel  
 Production time: 2 weeks

	I402000 White		I402001 Grey		I402002 Black		I402003 Blue
	I402004 Green		I402005 Red				







# FORM BAR CHAIR 75 CM FULL UPHOLSTERY STEEL

Design: Simon Legald, 2015  
 Awards: German Design Award 2016, Germany - "Special Mention" & IF Product Design Award 2016, Germany  
 Duty Code: 9401710000  
 Made in: Poland  
 Construction: The shell is made of high-quality polypropylene (PP) and has been molded using one single injection, ensuring an extremely strong construction with the finest surface possible. Form is delivered assembled.  
 Maintenance: Textile: Clean with textile or upholstery cleaner. Leather: Clean with a damp cloth. Use warm water with soap flakes. Frequent vacuuming with a soft fitting is recommended for both textile and leather to preserve color and appearance.



## Form Bar Chair 75 cm Full Upholstery Steel

Colli: 1  
 Size & Weight: H: 110 x W: 49 x D: 54,5 x SH: 75 cm - 5,9 kg  
 Packing: Brown Box - H: 110 x L: 51 x D: 56,5 cm - 8,2 kg  
 Material: Shell: Polypropylene (PP), PU Foam, Textile: Sorensen Leather/Ultra Leather, JAB/City Velvet, Camira/Main Line Flax, Camira/Synergy, Camira/Aquarius, Camira/Oceanic, Camira/Yoredale. Legs: Lacquered steel.  
 Production time: 6 weeks

	I402024 Ultra Leather
	I402025 Main Line Flax
	I402026 Synergy
	I402027 Aquarius
	I402028 Oceanic
	I402029 Yoredale

# FORM BAR ARMCHAIR 75 CM STEEL

Design: Simon Legald, 2014  
 Awards: German Design Award 2016, Germany - "Special Mention" & IF Product Design Award 2016, Germany  
 Duty Code: 9401790000  
 Made in: Denmark  
 Construction: The shell is made of high-quality polypropylene (PP) and has been molded using one single injection, ensuring an extremely strong construction with the finest surface possible. Form is delivered assembled.  
 Maintenance: Clean with damp cloth.

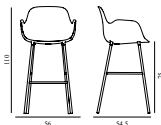

## Form Bar Armchair 75 cm Steel

Colli: 1  
 Size & Weight: H: 110 x W: 56 x D: 54,5 x SH: 75 cm - 6,6 kg  
 Packing: Brown Box - H: 110 x L: 56 x D: 58 cm - 8,6 kg  
 Material: Shell: Polypropylene, Legs: Powder coated steel  
 Production time: 2 weeks

	I402012 White		I402013 Grey		I402014 Black		I402015 Blue
			I402016 Green		I402017 Red		

# FORM BAR ARMCHAIR 75 CM FULL UPHOLSTERY STEEL

Design: Simon Legald, 2015  
 Awards: German Design Award 2016, Germany - "Special Mention" & IF Product Design Award 2016, Germany  
 Duty Code: 9401710000  
 Made in: Poland  
 Construction: The shell is made of high-quality polypropylene (PP) and has been molded using one single injection, ensuring an extremely strong construction with the finest surface possible. Form is delivered assembled.  
 Maintenance: Textile: Clean with textile or upholstery cleaner. Leather: Clean with a damp cloth. Use warm water with soap flakes. Frequent vacuuming with a soft fitting is recommended for both textile and leather to preserve color and appearance.

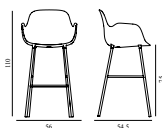

## Form Bar Armchair 75 cm Full Upholstery Steel

Colli: 1  
 Size & Weight: H: 110 x W: 56 x D: 54,5 x SH: 75 cm - 6,6 kg  
 Packing: Brown Box - H: 110 x L: 56 x D: 58 cm - 8,9 kg  
 Material: Shell: Polypropylene (PP), PU Foam, Textile: Sorensen Leather/Ultra Leather, JAB/City Velvet, Camira/Main Line Flax, Camira/Synergy, Camira/Aquarius, Camira/Oceanic, Camira/Yoredale. Legs: Lacquered steel.  
 Production time: 6 weeks

	I402066 Ultra Leather
	I402067 Main Line Flax
	I402068 Synergy
	I402069 Aquarius
	I402070 Oceanic
	I402071 Yoredale

# FORM TABLE H65 CM

Design: Simon Legald, 2014  
 Duty Code: 9403601000  
 Made in: Denmark  
 Construction: Form café table consists of a cylindrical center base in powder coated steel available in four heights. The tabletop comes in various sizes and shapes available in polished marble, oak veneer or matte stainless steel. The marble tabletops are treated with a surface treatment that penetrates into the material and thereby provides a long-term protection. The surface should not be exposed to acidic foods or beverages, which can leave stains on the surface.  
 Maintenance: Clean with a damp cloth.



## Form Café Table H65 Ø60 cm Oak

Colli: 1  
 Size & Weight: H: 65 x Ø: 60 cm - 17,7 kg  
 Packing: Tabletop: Brown Box - L: 63 x B: 63 x D: 4,5 cm - 5,5 kg - 0,018 m3 - Pillar: Brown Box - L: 65 x Ø: 7 cm - 2,3 kg - 0,37 m3 - Base: Brown Box - L: 50 x W: 50 x H: 4 cm - 13,5 kg - 0,01 m3  
 Material: Base in powder coated steel. Tabletop in oak veneer.  
 Color: Oak, Black oak  
 Production time: 2 weeks

604116  
Oak



## Form Café Table H65 Ø60 cm Marble

Colli: 1  
 Size & Weight: H: 65 x Ø: 60 cm - 26,8 kg  
 Packing: Base in powder coated steel. Tabletop in marble.  
 Color: Black, White, Sand, Coffee  
 Production time: 2 weeks

604117  
Marble





### Form Café Table H65 Ø60 cm Steel

Colli: 1  
Size & Weight: H: 65 x Ø: 60 cm - 22,8 kg  
Packing: Tabletop: Brown Box - L: 73 x B: 73 x D: 4,5 cm - 8,9 kg - 0,024 m<sup>3</sup> - Pillar: Brown Box - L: 65 x Ø: 7 cm - 2,3 kg - 0,37 m<sup>3</sup> - Base: Brown Box - L: 50 x B: 50 x H: 4 cm - 13,5 kg - 0,01 m<sup>3</sup>  
Material: Base in powder coated steel. Tabletop in brushed stainless steel.  
Color: Steel  
Production time: 2 weeks

604118  
Steel



### Form Café Table H65 Ø70 cm Oak

Colli: 1  
Size & Weight: H: 65 x Ø: 70 cm - 22,2 kg  
Packing: Tabletop: Brown Box - L: 73 x B: 73 x D: 4,5 cm - 8,9 kg - 0,024 m<sup>3</sup> - Pillar: Brown Box - L: 65 x Ø: 7 cm - 2,3 kg - 0,37 m<sup>3</sup> - Base: Brown Box - L: 50 x B: 50 x H: 4 cm - 13,5 kg - 0,01 m<sup>3</sup>  
Material: Base in powder coated steel. Tabletop in oak veneer.  
Color: Oak, Black oak  
Production time: 2 weeks

604119  
Oak



### Form Café Table H65 Ø70 cm Marble

Colli: 1  
Size & Weight: H: 65 x Ø: 70 cm - 32,4 kg  
Packing: Tabletop: Brown Box - L: 73 x B: 73 x D: 4,5 cm - 8,9 kg - 0,024 m<sup>3</sup> - Pillar: Brown Box - L: 65 x Ø: 7 cm - 2,3 kg - 0,37 m<sup>3</sup> - Base: Brown Box - L: 50 x B: 50 x H: 4 cm - 13,5 kg - 0,01 m<sup>3</sup>  
Material: Base in powder coated steel. Tabletop in polished marble.  
Color: Black, White, Sand, Coffee  
Production time: 2 weeks

604120  
Marble



### Form Café Table H65 Ø70 cm Steel

Colli: 1  
Size & Weight: H: 65 x Ø: 70 cm - 25,9 kg  
Packing: Tabletop: Brown Box - L: 73 x B: 73 x D: 4,5 cm - 8,9 kg - 0,024 m<sup>3</sup> - Pillar: Brown Box - L: 65 x Ø: 7 cm - 2,3 kg - 0,37 m<sup>3</sup> - Base: Brown Box - L: 50 x B: 50 x H: 4 cm - 13,5 kg - 0,01 m<sup>3</sup>  
Material: Base in powder coated steel. Tabletop in brushed stainless steel.  
Color: Steel  
Production time: 2 weeks

604121  
Steel



### Form Café Table H65 60x60 cm Oak

Colli: 1  
Size & Weight: H: 65 x W: 60 x L: 60 cm - 18,7 kg  
Packing: Tabletop: Brown Box - L: 63 x B: 63 x D: 4,5 cm - 6 kg - 0,018 m<sup>3</sup> - Pillar: Brown Box - L: 65 x Ø: 7 cm - 2,3 kg - 0,37 m<sup>3</sup> - Base: Brown Box - L: 50 x B: 50 x H: 4 cm - 13,5 kg - 0,01 m<sup>3</sup>  
Material: Base in powder coated steel. Tabletop in polished oak veneer.  
Color: Oak, Black oak  
Production time: 2 weeks

604122  
Oak



### Form Café Table H65 60x60 cm Steel

Colli: 1  
Size & Weight: H: 65 x W: 60 x L: 60 cm - 25,4 kg  
Packing: Tabletop: Brown Box - L: 63 x B: 63 x D: 4,5 cm - 6 kg - 0,018 m<sup>3</sup> - Pillar: Brown Box - L: 65 x Ø: 7 cm - 2,3 kg - 0,37 m<sup>3</sup> - Base: Brown Box - L: 50 x B: 50 x H: 4 cm - 13,5 kg - 0,01 m<sup>3</sup>  
Material: Base in powder coated steel. Tabletop in polished brushed stainless steel.  
Color: Steel  
Production time: 2 weeks

604123  
Steel



### Form Café Table H65 70x70 cm Oak

Colli: 1  
Size & Weight: H: 65 x W: 70 x L: 70 cm - 20,8 kg  
Packing: Tabletop: Brown Box - L: 73 x B: 73 x D: 4,5 cm - 8,9 kg - 0,024 m<sup>3</sup> - Pillar: Brown Box - L: 65 x Ø: 7 cm - 2,3 kg - 0,37 m<sup>3</sup> - Base: Brown Box - L: 50 x B: 50 x H: 4 cm - 13,5 kg - 0,01 m<sup>3</sup>  
Material: Base in powder coated steel. Tabletop in oak veneer.  
Color: Oak, Black oak  
Production time: 2 weeks

604124  
Oak



### Form Café Table H65 70x70 cm Marble

Colli: 1  
Size & Weight: H: 65 x W: 70 x L: 70 cm - 41,5 kg  
Packing:  
Material: Base in powder coated steel. Tabletop in polished marble.  
Color: Black, White, Sand, Coffee  
Production time: 2 weeks

604125  
Marble



### Form Café Table H65 70x70 cm Steel

Colli: 1  
Size & Weight: H: 65 x W: 70 x L: 70 cm - 29,6 kg  
Packing:  
Material: Base in powder coated steel. Tabletop in brushed stainless steel.  
Color: Steel  
Production time: 2 weeks

604126  
Steel

## FORM TABLE H74,5 CM

Design: Simon Legald, 2014  
Duty Code: 9403890090  
Made in: Denmark

Construction: Form café table consists of a cylindrical center base in powder coated steel available in four heights. The tabletop comes in various sizes and shapes available in polished marble, oak veneer or matte stainless steel. The marble tabletops are treated with a surface treatment that penetrates into the material and thereby provides a long-term protection. The surface should not be exposed to acidic foods or beverages, which can leave stains on the surface.

Maintenance: Clean with a damp cloth.



### Form Café Table H74,5 Ø60 cm Oak

Colli: 1  
Size & Weight: H: 74,5 x Ø: 60 cm - 17,9 kg  
Packing: Tabletop: Brown Box - L: 63 x B: 63 x D: 4,5 cm - 5,5 kg - 0,018 m<sup>3</sup> - Pillar: Brown Box - L: 77 x Ø: 7 cm - 2,5 kg - 0,49 m<sup>3</sup> - Base: Brown Box - L: 50 x B: 50 x H: 4 cm - 13,5 kg - 0,01 m<sup>3</sup>  
Material: Base in powder coated steel. Tabletop in oak veneer.  
Color: Oak, Black oak  
Production time: 2 weeks

604127  
Oak



### Form Café Table H74,5 Ø60 cm Marble

Colli: 1  
Size & Weight: H: 74,5 x Ø: 60 cm - 27 kg  
Packing:  
Material: Base in powder coated steel. Tabletop in polished marble.  
Color: Black, White, Sand, Coffee  
Production time: 2 weeks

604128  
Marble



### Form Café Table H74,5 Ø60 cm Steel

Colli: 1  
Size & Weight: H: 74,5 x Ø: 60 cm - 23 kg  
Packing:  
Material: Base in powder coated steel. Tabletop in brushed stainless steel.  
Color: Steel  
Production time: 2 weeks

604129  
Steel



### Form Café Table H74,5 Ø70 cm Oak

Colli: 1  
Size & Weight: H: 74,5 x Ø: 70 cm - 22,4 kg  
Packing: Tabletop: Brown Box - L: 73 x B: 73 x D: 4,5 cm - 8,9 kg - 0,024 m<sup>3</sup> - Pillar: Brown Box - L: 77 x Ø: 7 cm - 2,5 kg - + 0,49 m<sup>3</sup> - Base: Brown Box - L: 50 x B: 50 x H: 4 cm - 13,5 kg - 0,01 m<sup>3</sup>  
Material: Base in powder coated steel. Tabletop in oak veneer.  
Color: Oak, Black oak  
Production time: 2 weeks

604130  
Oak



### Form Café Table H74,5 Ø70 cm Marble

Colli: 1  
Size & Weight: H: 74,5 x Ø: 70 cm - 32,6 kg  
Packing: Tabletop: Brown Box - L: 73 x B: 73 x D: 4,5 cm - 8,9 kg - 0,024 m<sup>3</sup> - Pillar: Brown Box - L: 77 x Ø: 7 cm - 2,5 kg - 0,49 m<sup>3</sup> - Base: Brown Box - L: 50 x B: 50 x H: 4 cm - 13,5 kg - 0,01 m<sup>3</sup>  
Material: Base in powder coated steel. Tabletop in polished marble.  
Color: Black, White, Sand, Coffee  
Production time: 2 weeks

604131  
Marble



### Form Café Table H74,5 Ø70 cm Steel

Colli: 1  
Size & Weight: H: 74,5 x Ø: 70 cm - 26,1 kg  
Packing: Tabletop: Brown Box - L: 73 x B: 73 x D: 4,5 cm - 8,9 kg - 0,024 m<sup>3</sup> - Pillar: Brown Box - L: 77 x Ø: 7 cm - 2,5 kg - 0,49 m<sup>3</sup> - Base: Brown Box - L: 50 x B: 50 x H: 4 cm - 13,5 kg - 0,01 m<sup>3</sup>  
Material: Base in powder coated steel. Tabletop in brushed stainless steel.  
Color: Steel  
Production time: 2 weeks

604132  
Steel



### Form Café Table H74,5 60x60 cm Oak

Colli: 1  
Size & Weight: H: 74,5 x W: 60 x L: 60 cm - 18,9 kg  
Packing: Tabletop: Brown Box - L: 63 x B: 63 x D: 4,5 cm - 6 kg - 0,018 m<sup>3</sup> - Pillar: Brown Box - L: 77 x Ø: 7 cm - 2,5 kg - 0,49 m<sup>3</sup> - Base: Brown Box - L: 50 x B: 50 x H: 4 cm - 13,5 kg - 0,01 m<sup>3</sup>  
Material: Base in powder coated steel. Tabletop in oak veneer.  
Color: Oak, Black oak  
Production time: 2 weeks

604133  
Oak



### Form Café Table H74,5 60x60 cm Steel

Colli: 1  
Size & Weight: H: 74,5 x W: 60 x L: 60 cm - 25,6 kg  
Packing: Tabletop: Brown Box - L: 63 x B: 63 x D: 4,5 cm - 6 kg - 0,018 m<sup>3</sup> - Pillar: Brown Box - L: 77 x Ø: 7 cm - 2,5 kg - 0,49 m<sup>3</sup> - Base: Brown Box - L: 50 x B: 50 x H: 4 cm - 13,5 kg - 0,01 m<sup>3</sup>  
Material: Base in powder coated steel. Tabletop in brushed stainless steel.  
Color: Steel  
Production time: 2 weeks

604134  
Steel



### Form Café Table H74,5 70x70 cm Oak

Colli: 1  
Size & Weight: H: 74,5 x W: 70 x L: 70 cm - 21 kg  
Packing: Tabletop: Brown Box - L: 73 x B: 73 x D: 4,5 cm - 8,9 kg - 0,024 m<sup>3</sup> - Pillar: Brown Box - L: 77 x Ø: 7 cm - 2,5 kg - 0,49 m<sup>3</sup> - Base: Brown Box - L: 50 x B: 50 x H: 4 cm - 13,5 kg - 0,01 m<sup>3</sup>  
Material: Base in powder coated steel. Tabletop in oak veneer.  
Color: Oak, Black oak  
Production time: 2 weeks

604135  
Oak



### Form Café Table H74,5 70x70 cm Marble

Colli: 1  
Size & Weight: H: 74,5 x W: 70 x L: 70 cm - 41,7 kg  
Packing: Tabletop: Brown Box - L: 73 x B: 73 x D: 4,5 cm - 8,9 kg - 0,024 m<sup>3</sup> - Pillar: Brown Box - L: 77 x Ø: 7 cm - 2,5 kg - 0,49 m<sup>3</sup> - Base: Brown Box - L: 50 x B: 50 x H: 4 cm - 13,5 kg - 0,01 m<sup>3</sup>  
Material: Base in powder coated steel. Tabletop in polished marble.  
Color: Black, White, Sand, Coffee  
Production time: 2 weeks

604136  
Marble



<b>Form Café Table H74,5 70x70 cm Steel</b> Colli: 1 Size & Weight: H: 74,5 x W: 70 x L: 70 cm - 29,8 kg Packing: Material: Base in powder coated steel. Tabletop in brushed stainless steel. Color: Steel Production time: 2 weeks	604137 Steel
-------------------------------------------------------------------------------------------------------------------------------------------------------------------------------------------------------------------------------------------------------	-----------------

## FORM TABLE H94,5 CM

Design: Simon Legald, 2014  
Duty Code: 9403890090  
Made in: Denmark

Construction: Form café table consists of a cylindrical center base in powder coated steel available in four heights. The tabletop comes in various sizes and shapes available in polished marble, oak veneer or matte stainless steel. The marble tabletops are treated with a surface treatment that penetrates into the material and thereby provides a long-term protection. The surface should not be exposed to acidic foods or beverages, which can leave stains on the surface.

Maintenance: Clean with a damp cloth.

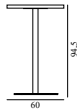

<b>Form Café Table H94,5 Ø60 cm Oak</b> Colli: 1 Size & Weight: H: 94,5 x Ø: 60 cm - 18,4 kg Packing: Tabletop: Brown Box - L: 63 x B: 63 x D: 4,5 cm - 5,5 kg - 0,018 m <sup>3</sup> - Pillar: Brown Box - L: 97 x Ø: 7 cm - 3 kg - 0,62 m <sup>3</sup> - Base: Brown Box - L: 50 x B: 50 x H: 4 cm - 13,5 kg - 0,01 m <sup>3</sup> Material: Base in powder coated steel. Tabletop in oak veneer. Color: Oak, Black oak Production time: 2 weeks	604138 Oak
----------------------------------------------------------------------------------------------------------------------------------------------------------------------------------------------------------------------------------------------------------------------------------------------------------------------------------------------------------------------------------------------------------------------------------------------------------------------	---------------

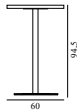

<b>Form Café Table H94,5 Ø60 cm Marble</b> Colli: 1 Size & Weight: H: 94,5 x Ø: 60 cm - 27,5 kg Packing: Material: Base in powder coated steel. Tabletop in polished marble. Color: Black, White, Sand, Coffee Production time: 2 weeks	604139 Marble
-----------------------------------------------------------------------------------------------------------------------------------------------------------------------------------------------------------------------------------------------------------	------------------

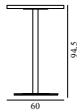

<b>Form Café Table H94,5 Ø60 cm Steel</b> Colli: 1 Size & Weight: H: 94,5 x Ø: 60 cm - 23,5 kg Packing: Material: Base in powder coated steel. Tabletop in brushed stainless steel. Color: Steel Production time: 2 weeks	604140 Steel
---------------------------------------------------------------------------------------------------------------------------------------------------------------------------------------------------------------------------------------------	-----------------

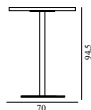

<b>Form Café Table H94,5 Ø70 cm Oak</b> Colli: 1 Size & Weight: H: 94,5 x Ø: 70 cm - 22,9 kg Packing: Tabletop: Brown Box - L: 73 x B: 73 x D: 4,5 cm - 8,9 kg - 0,024 m <sup>3</sup> - Pillar: Brown Box - L: 97 x Ø: 7 cm - 3 kg - 0,62 m <sup>3</sup> - Base: Brown Box - L: 50 x B: 50 x H: 4 cm - 13,5 kg - 0,01 m <sup>3</sup> Material: Base in powder coated steel. Tabletop in oak veneer. Color: Oak, Black oak Production time: 2 weeks	604141 Oak
----------------------------------------------------------------------------------------------------------------------------------------------------------------------------------------------------------------------------------------------------------------------------------------------------------------------------------------------------------------------------------------------------------------------------------------------------------------------	---------------

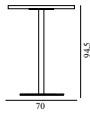

### Form Café Table H94,5 Ø70 cm Marble

Colli: 1  
Size & Weight: H: 94,5 x Ø: 70 cm - 33,1 kg  
Packing:  
Material: Base in powder coated steel. Tabletop in polished marble.  
Color: Black, White, Sand, Coffee  
Production time: 2 weeks

604142  
Marble

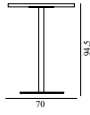

### Form Café Table H94,5 Ø70 cm Steel

Colli: 1  
Size & Weight: H: 94,5 x Ø: 70 cm - 26,6 kg  
Packing:  
Material: Base in powder coated steel. Tabletop in brushed stainless steel.  
Color: Steel  
Production time: 2 weeks

604143  
Steel

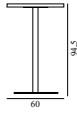

### Form Café Table H94,5 60x60 cm Oak

Colli: 1  
Size & Weight: H: 94,5 x W: 60 x L: 60 cm - 19,4 kg  
Packing: Tabletop: Brown Box - L: 63 x B: 63 x D: 4,5 cm - 6 kg - 0,018 m<sup>3</sup> - Pillar: Brown Box - L: 97 x Ø: 7 cm - 3 kg - 0,62 m<sup>3</sup> - Base: Brown Box - L: 50 x B: 50 x H: 4 cm - 13,5 kg - 0,01 m<sup>3</sup>  
Material: Base in powder coated steel. Tabletop in oak veneer.  
Color: Oak, Black oak  
Production time: 2 weeks

604144  
Oak



### Form Café Table H94,5 60x60 cm Steel

Colli: 1  
Size & Weight: H: 94,5 x W: 60 x L: 60 cm - 26,1 kg  
Packing:  
Material: Base in powder coated steel. Tabletop in brushed stainless steel.  
Color: Steel  
Production time: 2 weeks

604145  
Steel



### Form Café Table H94,5 70x70 cm Oak

Colli: 1  
Size & Weight: H: 94,5 x W: 70 x L: 70 cm - 21,5 kg  
Packing: Tabletop: Brown Box - L: 73 x B: 73 x D: 4,5 cm - 7,5 kg - 0,024 m<sup>3</sup> - Pillar: Brown Box - L: 97 x Ø: 7 cm - 3 kg - 0,62 m<sup>3</sup> - Base: Brown Box - L: 50 x B: 50 x H: 4 cm - 13,5 kg - 0,01 m<sup>3</sup>  
Material: Base in powder coated steel. Tabletop in oak veneer.  
Color: Oak, Black oak  
Production time: 2 weeks

604146  
Oak

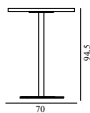

### Form Café Table H94,5 70x70 cm Marble

Colli: 1  
Size & Weight: H: 94,5 x W: 70 x L: 70 cm - 42,2 kg  
Packing:  
Material: Base in powder coated steel. Tabletop in polished marble.  
Color: Black, White, Sand, Coffee  
Production time: 2 weeks

604147  
Marble

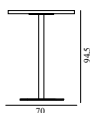

### Form Café Table H94,5 70x70 cm Steel

Colli: 1  
Size & Weight: H: 94,5 x W: 70 x L: 70 cm - 30,3 kg  
Packing:  
Material: Base in powder coated steel. Tabletop in brushed stainless steel.  
Color: Steel  
Production time: 2 weeks

604148  
Steel

# FORM TABLE H104,5 CM

Design: Simon Legald, 2014

Duty Code: 9403890090

Made in: Denmark

Construction: Form café table consists of a cylindrical center base in powder coated steel available in four heights. The tabletop comes in various sizes and shapes available in polished marble, oak veneer or matte stainless steel. The marble tabletops are treated with a surface treatment that penetrates into the material and thereby provides a long-term protection. The surface should not be exposed to acidic foods or beverages, which can leave stains on the surface.

Maintenance: Clean with a damp cloth.



## Form Café Table H104,5 Ø60 cm Oak

Colli: 1  
Size & Weight: H: 104,5 x Ø: 60 cm - 18,5 kg  
Packing: Tabletop: Brown Box - L: 63 x B: 63 x D: 4,5 cm - 5,5 kg - 0,018 m<sup>3</sup> - Pillar: Brown Box - L: 113 x Ø: 7 cm - 3,1 kg - 0,71 m<sup>3</sup> - Base: Brown Box - L: 50 x B: 50 x H: 4 cm - 13,5 kg - 0,01 m<sup>3</sup>  
Material: Base in powder coated steel. Tabletop in oak veneer.  
Color: Oak, Black oak  
Production time: 2 weeks

604149  
Oak

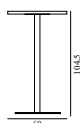

## Form Café Table H104,5 Ø60 cm Marble

Colli: 1  
Size & Weight: H: 104,5 x Ø: 60 cm - 27,6 kg  
Packing: Base in powder coated steel. Tabletop in polished marble.  
Material: Base in powder coated steel. Tabletop in polished marble.  
Color: Black, White, Sand, Coffee  
Production time: 2 weeks

604150  
Marble



## Form Café Table H104,5 Ø60 cm Steel

Colli: 1  
Size & Weight: H: 104,5 x Ø: 60 cm - 23,6 kg  
Packing: Base in powder coated steel. Tabletop in brushed stainless steel.  
Material: Base in powder coated steel. Tabletop in brushed stainless steel.  
Color: Steel  
Production time: 2 weeks

604151  
Steel

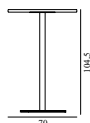

## Form Café Table H104,5 Ø70 cm Oak

Colli: 1  
Size & Weight: H: 104,5 x Ø: 70 cm - 23 kg  
Packing: Tabletop: Brown Box - L: 73 x B: 73 x D: 4,5 cm - 8,9 kg - 0,024 m<sup>3</sup> - Pillar: Brown Box - L: 113 x Ø: 7 cm - 3,1 kg - 0,71 m<sup>3</sup> - Base: Brown Box - L: 50 x B: 50 x H: 4 cm - 13,5 kg - 0,01 m<sup>3</sup>  
Material: Base in powder coated steel. Tabletop in oak veneer.  
Color: Oak, Black oak  
Production time: 2 weeks

604152  
Oak

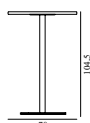

## Form Café Table H104,5 Ø70 cm Marble

Colli: 1  
Size & Weight: H: 104,5 x Ø: 70 cm - 33,2 kg  
Packing: Base in powder coated steel. Tabletop in polished marble.  
Material: Base in powder coated steel. Tabletop in polished marble.  
Color: Black, White, Sand, Coffee  
Production time: 2 weeks

604153  
Marble

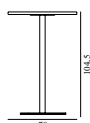

## Form Café Table H104,5 Ø70 cm Steel

Colli: 1  
Size & Weight: H: 104,5 x Ø: 70 cm - 26,7 kg  
Packing: Base in powder coated steel. Tabletop in brushed stainless steel.  
Material: Base in powder coated steel. Tabletop in brushed stainless steel.  
Color: Steel  
Production time: 2 weeks

604154  
Steel

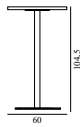

### Form Café Table H104,5 60x60 cm Oak

Colli: 1  
Size & Weight: H: 104,5 x W: 60 x L: 60 cm - 19,5 kg  
Packing: Tabletop: Brown Box - L: 63 x B: 63 x D: 4,5 cm - 6 kg - 0,018 m<sup>3</sup> - Pillar: Brown Box - L: 113 x Ø: 7 cm - 3,1 kg - 0,71 m<sup>3</sup> - Base: Brown Box - L: 50 x B: 50 x H: 4 cm - 13,5 kg - 0,01 m<sup>3</sup>  
Material: Base in powder coated steel. Tabletop in oak veneer.  
Color: Oak, Black oak  
Production time: 2 weeks

604155  
Oak



### Form Café Table H104,5 60x60 cm Steel

Colli: 1  
Size & Weight: H: 104,5 x W: 60 x L: 60 cm - 26,2 kg  
Packing: Base in powder coated steel. Tabletop in brushed stainless steel.  
Material: Base in powder coated steel. Tabletop in brushed stainless steel.  
Color: Steel  
Production time: 2 weeks

604156  
Steel

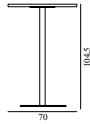

### Form Café Table H104,5 70x70 cm Oak

Colli: 1  
Size & Weight: H: 104,5 x W: 70 x L: 70 cm - 21,6 kg  
Packing: Tabletop: Brown Box - L: 73 x B: 73 x D: 4,5 cm - 7,5 kg - 0,024 m<sup>3</sup> - Pillar: Brown Box - L: 113 x Ø: 7 cm - 3,1 kg - 0,71 m<sup>3</sup> - Base: Brown Box - L: 50 x B: 50 x H: 4 cm - 13,5 kg - 0,01 m<sup>3</sup>  
Material: Base in powder coated steel. Tabletop in oak veneer.  
Color: Oak, Black oak  
Production time: 2 weeks

604157  
Oak



### Form Café Table H104,5 70x70 cm Marble

Colli: 1  
Size & Weight: H: 104,5 x W: 70 x L: 70 cm - 42,3 kg  
Packing: Base in powder coated steel. Tabletop in polished marble.  
Material: Base in powder coated steel. Tabletop in polished marble.  
Color: Black, White, Sand, Coffee  
Production time: 2 weeks

604158  
Marble

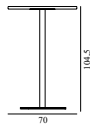

### Form Café Table H104,5 70x70 cm Steel

Colli: 1  
Size & Weight: H: 104,5 x W: 70 x L: 70 cm - 30,4 kg  
Packing: Base in powder coated steel. Tabletop in brushed stainless steel.  
Material: Base in powder coated steel. Tabletop in brushed stainless steel.  
Color: Steel  
Production time: 2 weeks

604159  
Steel

## FORM TABLE

Design: Simon Legald, 2014

Duty Code: 9403601000

Made in: Denmark

Construction: A perfect match for the Form Chair. The table comes flat packed. Easily assembled by following the included manual.

Maintenance: Daily cleaning: Wipe with a damp cloth. Use a PH-neutral cleaning product. Thorough cleaning and maintenance: Use a special linoleum cleaner followed by a linoleum care product.

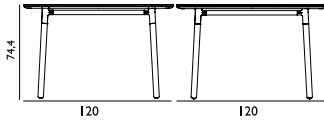

### Form Table 120 x 120 cm

Colli: 1  
 Size & Weight: H: 74,4 x W: 120 x L: 120 cm - 34 kg  
 Packing: Brown Box - H: 126 x L: 126 x D: 18 cm - 38 kg  
 Material: Tabletop: Linoleum, Laminate (white version only), Legs: Oak  
 Production time: 5 weeks

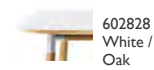

602828  
White /  
Oak

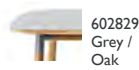

602829  
Grey /  
Oak

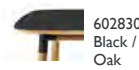

602830  
Black /  
Oak

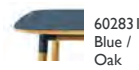

602831  
Blue /  
Oak



602832  
Green /  
Oak



602833  
Red /  
Oak

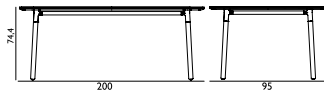

### Form Table 95 x 200 cm

Colli: 1  
 Size & Weight: H: 74,4 x W: 95 x L: 200 cm - 44 kg  
 Packing: Brown Box - H: 206 x L: 101 x D: 18 cm - 48 kg  
 Material: Tabletop: Linoleum, Laminate (white version only), Legs: Oak  
 Production time: 5 weeks



602834  
White /  
Oak



602835  
Grey /  
Oak

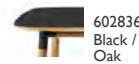

602836  
Black /  
Oak



602837  
Blue /  
Oak



602838  
Green /  
Oak



602839  
Red /  
Oak

## FORM GLIDES

Duty Code: 9401999090

Construction: Different types of flooring require different types of glides.

Maintenance: We recommend to check the glides every 3-6 months. If worn down, please replace.

### Form Chair & Barstool Glides Steel

Size & Weight: Ø: 2 cm - 0,12 kg



900104  
PE for steel /  
Black /  
4pcs



900105  
PE for steel w. felt /  
Black /  
4pcs

### Form Chair & Barstool Glides Wood

Size & Weight: Ø: 2,4 cm - 0,12 kg



900103  
PS for wood w. felt /  
Black /  
4pcs



900236  
POM for wood /  
White /  
4pcs

### Form Chair Swivel Glides



900237  
PE swivel /  
Black /  
4pcs



## FORM STACKING GLIDERS

Design: Simon Legald, 2022  
 Duty Code: 9403910090  
 Made in: Sweden

### Form Stacking Gliders

Size & Weight: Ø: 2 cm  
 Packing: Poly Bag - (4 pcs)  
 Material: Nylon



900500



900501

## FORM SEAT CUSHION

Design: Simon Legald, 2016  
 Duty Code: 9404909000  
 Made in: Lithuania

Construction: The Seat Cushion is sewn with non-slip backside, and fabric or leather front.

Maintenance: Textile: Clean with textile or upholstery cleaner. Leather: Clean with a damp cloth. Use warm water with soap flakes. Frequent vacuuming with a soft fitting is recommended for both textile and leather to preserve color and appearance.



### Form Seat Cushion Leather

Colli: I  
 Size & Weight: H: 1 x W: 46 x D: 39 cm - 0,7 kg  
 Packing: Clear poly bag  
 Material: Sørensens Ultra leather on top, foam, and rubber fabric on backside.



602636  
White 41594



602637  
Brandy 41574



602638  
Black 41599



602896  
Camel 41571



### Form Seat Cushion

Colli: I  
 Size & Weight: H: 1 x W: 46 x D: 39 cm - 0,7 kg  
 Packing: Clear poly bag  
 Material: Camira Main Line Flax on top, foam, and rubber fabric on backside.



602598  
Grey MLF26



602894  
MLF20 Sand



602895  
Black MLF28



602897  
Blue MLF36



602898  
Green MLF29



602899  
Red MLF14

## CHAIR RACK

Design: Hans Hornemann, 2017  
 Duty Code: 9403991010  
 Made in: Denmark  
 Construction: Capacity: Chair Rack Single can hold up to 15 chairs and Chair Rack Double can hold up to 30 chairs. Suitable for stacking chairs from the Form, Just, Studio and My Chair collections.



### Chair Rack Single

Colli: I  
 Size & Weight: H: 104,5 x W: 65 x L: 93 cm - 17,5 kg  
 Packing: Brown Box - H: 60 x L: 95 x D: 67 cm  
 Material: Powder Coated Steel



601110  
Black





<b>Chair Rack Double</b> Colli: 1 Size & Weight: H: 105,5 x W: 135 x L: 102 cm - 35 kg Packing: Brown Box - H: 57 x L: 95 x D: 137 cm Material: Powder Coated Steel		 601111 Black
---------------------------------------------------------------------------------------------------------------------------------------------------------------------------------	--	-----------------------------------------------------------------------------------------------------

## CHAIR SUSPENSION

Duty Code: 9403991010  
 Made in: Denmark  
 Construction: The Chair suspension is suitable for Union Table, and fits the Form Chair, Just Chair and My Chair.



<b>Chair Suspension</b> Size & Weight: H: 10 x L: 33 x D: 22 cm - 2,5 kg Packing: Brown Box - H: 12 x L: 34 x D: 23 cm Production time: 2 weeks		
 602667 White	 602668 Grey	 602669 Black

## GROW

Design: Simon Legald, 2017  
 Duty Code: 9403601000  
 Made in: Lithuania  
 Construction: Grow Table is delivered assembled.  
 Maintenance: Clean with damp cloth.

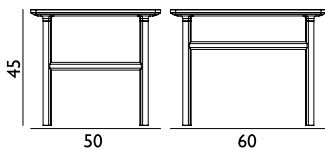

<b>Grow Table 50 x 60 cm</b> Colli: 1 Size & Weight: H: 45 x W: 60 x L: 50 cm - 8 kg Packing: Brown Box - H: 48,5 x L: 66 x D: 64 cm - 10 kg Material: Lacquered oak or painted and lacquered oak		
 1401830 Black	 602278 Oak	 602279 Smoked oak

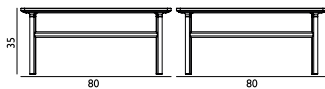

<b>Grow Table 80 x 80 cm</b> Colli: 1 Size & Weight: H: 35 x W: 80 x L: 80 cm - 15 kg Packing: Brown Box - H: 38 x L: 85 x D: 85 cm - 18 kg Material: Lacquered oak or painted and lacquered oak		
 1401831 Black	 602280 Oak	 602281 Smoked oak

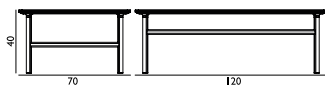



<b>Grow Table 70 x 120 cm</b> Colli: 1 Size & Weight: H: 40 x W: 70 x L: 120 cm - 20 kg Packing: Brown Box - H: 44 x L: 126 x D: 74,5 cm - 23 kg Material: Lacquered oak or painted and lacquered oak		
 1401832 Black	 602282 Oak	 602283 Smoked oak

# HERIT GLIDES

Duty Code: 940199090

Construction: Different types of flooring require different types of glides.

Maintenance: We recommend to check the glides every 3-6 months. If worn down, please replace.

Herit Chair Glides	
	900110 PE / Black / 4pcs
	900111 PE w. felt / Black / 4pcs

# HERIT CHAIR

Design: Simon Legald, 2018





Duty Code: 9401690000

Made in: Denmark

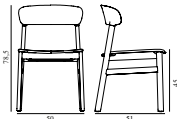



Construction: The polypropylene (PP) parts are molded and injected with a core of foam. This innovative, patented technique enables large variations in thickness without the polypropylene subsiding. Legs are made of solid wood. Herit comes assembled.

Maintenance: Clean with damp cloth.

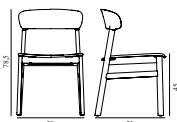

Herit Chair Oak			
Colli: 1 Size & Weight: H: 78,5 x W: 50 x D: 51 x SH: 45 cm - 6,2 kg Packing: Brown Box - H: 96 x L: 70 x D: 53 cm (2 pcs) - 15,2 kg Material: Shell: Polypropylene, Legs: Oak Production time: 2 weeks			
 1401000 White	 1401001 Grey	 1401002 Black	 1401003 Sand
 1401004 Dusty Green			



Herit Chair Smoked Oak			
Colli: 1 Size & Weight: H: 78,5 x W: 50 x D: 51 x SH: 45 cm - 6,2 kg Packing: Brown Box - H: 96 x L: 70 x D: 53 cm (2 pcs) - 15,2 kg Material: Shell: Polypropylene, Legs: Painted and Lacquered Oak Production time: 2 weeks			
 1401005 White	 1401006 Grey	 1401007 Black	 1401008 Sand
 1401009 Dusty Green			

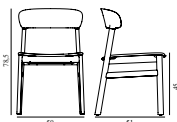

Herit Chair Black Oak
Colli: 1 Size & Weight: H: 78,5 x W: 50 x D: 51 x SH: 45 cm - 6,2 kg Packing: Brown Box - H: 96 x L: 70 x D: 53 cm (2 pcs) - 15,2 kg Material: Shell: Polypropylene, Legs: Painted and Lacquered Oak. Production time: 2 weeks
 1401056 Black

# HERIT CHAIR UPHOLSTERY

Design: Simon Legald, 2018

Duty Code: 9401610000

Made in: Denmark

Construction: The polypropylene (PP) parts are molded and injected with a core of foam. This innovative, patented technique enables large variations in thickness without the polypropylene subsiding. Legs are made of solid wood. Herit comes assembled.

Maintenance: Textile: Clean with textile or upholstery cleaner. Leather: Clean with a damp cloth. Use warm water with soap flakes. Frequent vacuuming with a soft fitting is recommended for both textile and leather to preserve color and appearance.

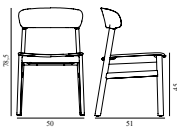

## Herit Chair Upholstery Oak

Colli: 1  
 Size & Weight: H: 78,5 x W: 50 x D: 51 x SH: 45 cm - 6,2 kg  
 Packing: Brown Box - H: 96 x L: 70 x D: 53 cm (2 pcs) - 15,2 kg  
 Material: Backrest: Polypropylene, Seat: Camira/Synergy or Sørensen/Spectrum Leather; Legs: Oak  
 Production time: 2 weeks

	1401010 Synergy Grey
	1401011 Synergy Black
	1401012 Synergy Sand
	1401013 Synergy Dusty Green
	1401018 Spectrum Leather White
	1401019 Spectrum Leather Grey
	1401020 Spectrum Leather Black
	1401021 Spectrum Leather Sand
	1401022 Spectrum Leather Dusty Green

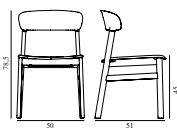

## Herit Chair Upholstery Smoked Oak

Colli: 1  
 Size & Weight: H: 78,5 x W: 50 x D: 51 x SH: 45 cm - 6,2 kg  
 Packing: Brown Box - H: 96 x L: 70 x D: 53 cm (2 pcs) - 15,2 kg  
 Material: Backrest: Polypropylene, Seat: Camira/Synergy or Sørensen/Spectrum Leather; Legs: Painted and Lacquered Oak  
 Production time: 2 weeks

	1401014 Synergy Grey
	1401015 Synergy Black
	1401016 Synergy Sand
	1401017 Synergy Dusty Green
	1401023 Spectrum Leather White
	1401024 Spectrum Leather Grey
	1401025 Spectrum Leather Black
	1401026 Spectrum Leather Sand
	1401027 Spectrum Leather Dusty Green

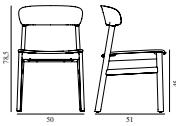

### Herit Chair Upholstery Black Oak

Colli: 1  
 Size & Weight: H: 78,5 x W: 50 x D: 51 x SH: 45 cm - 6,2 kg  
 Packing: Brown Box - H: 96 x L: 70 x D: 53 cm (2 pcs) - 15,2 kg  
 Material: Backrest: Polypropylene, Seat: Camira/Synergy or Sørensen/Spectrum Leather, Legs: Painted and Lacquered Oak.  
 Production time: 2 weeks



1401057  
Synergy Black



1401058  
Spectrum Leather  
Black

## HERIT ARMCHAIR

Design: Simon Legald, 2018  
 Duty Code: 9401690000  
 Made in: Denmark  
 Construction: The polypropylene (PP) parts are molded and injected with a core of foam. This innovative, patented technique enables large variations in thickness without the polypropylene subsiding. Legs are made of solid wood. Herit comes assembled.  
 Maintenance: Clean with damp cloth.

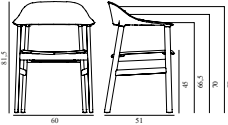

### Herit Armchair Oak

Colli: 1  
 Size & Weight: H: 81,5 x W: 60 x D: 51 x SH: 45 cm - 7 kg  
 Packing: Brown Box - H: 88 x L: 70 x D: 54 cm - 9,3 kg  
 Material: Shell: Polypropylene, Legs: Oak  
 Production time: 2 weeks



1401028  
White



1401029  
Grey



1401030  
Black



1401031  
Sand



1401032  
Dusty Green

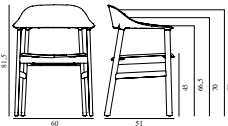

### Herit Armchair Smoked Oak

Colli: 1  
 Size & Weight: H: 81,5 x W: 60 x D: 51 x SH: 45 cm - 7 kg  
 Packing: Brown Box - H: 88 x L: 60 x D: 54 cm - 9,3 kg  
 Material: Shell: Polypropylene, Legs: Painted and Lacquered Oak  
 Production time: 2 weeks



1401033  
White



1401034  
Grey



1401035  
Black



1401036  
Sand



1401037  
Dusty Green

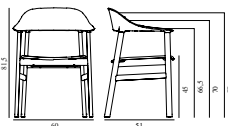

### Herit Armchair Black Oak

Colli: 1  
 Size & Weight: H: 81,5 x W: 60 x D: 51 x SH: 45 cm - 7 kg  
 Packing: Brown Box - H: 88 x L: 60 x D: 54 cm - 9,3 kg  
 Material: Shell: Polypropylene, Legs: Painted and Lacquered Oak.  
 Production time: 2 weeks



1401059  
Black

# HERIT ARMCHAIR UPHOLSTERY

Design: Simon Legald, 2018

Duty Code: 9401610000

Made in: Denmark



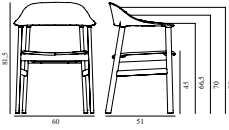

Construction: The polypropylene (PP) parts are molded and injected with a core of foam. This innovative, patented technique enables large variations in thickness without the polypropylene subsiding. Legs are made of solid wood. Herit comes assembled.

Maintenance: Textile: Clean with textile or upholstery cleaner. Leather: Clean with a damp cloth. Use warm water with soap flakes. Frequent vacuuming with a soft fitting is recommended for both textile and leather to preserve color and appearance.



## Herit Armchair Upholstery Oak

Colli: 1  
 Size & Weight: H: 81,5 x W: 60 x D: 51 x SH: 45 cm - 7 kg  
 Packing: Brown Box - H: 88 x L: 60 x D: 54 cm - 9,3 kg  
 M3: 0,2851  
 Material: Backrest: Polypropylene, Seat: Camira/Synergy or Sørensen/Spectrum Leather; Legs: Oak  
 Production time: 2 weeks

	1401038 Synergy Grey
	1401039 Synergy Black
	1401040 Synergy Sand
	1401041 Synergy Dusty Green
	1401046 Spectrum Leather White
	1401047 Spectrum Leather Grey
	1401048 Spectrum Leather Black
	1401049 Spectrum Leather Sand
	1401050 Spectrum Leather Dusty Green

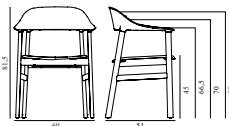

## Herit Armchair Upholstery Smoked Oak

Colli: 1  
 Size & Weight: H: 81,5 x W: 60 x D: 51 x SH: 45 cm - 7 kg  
 Packing: Brown Box - H: 88 x L: 60 x D: 54 cm - 9,3 kg  
 M3: 0,2851  
 Material: Backrest: Polypropylene, Seat: Camira/Synergy or Sørensen/Spectrum Leather; Legs: Painted and Lacquered Oak  
 Production time: 2 weeks

	1401042 Synergy Grey
	1401043 Synergy Black
	1401044 Synergy Sand
	1401045 Synergy Dusty Green
	1401051 Spectrum Leather White
	1401052 Spectrum Leather Grey
	1401053 Spectrum Leather Black
	1401054 Spectrum Leather Sand
	1401055 Spectrum Leather Dusty Green

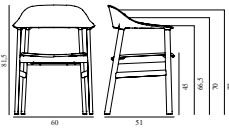

### Herit Armchair Upholstery Black Oak

Colli: 1  
 Size & Weight: H: 81,5 x W: 60 x D: 51 x SH: 45 cm - 7 kg  
 Packing: Brown Box - H: 88 x L: 60 x D: 54 cm - 9,3 kg  
 M3: 0,2851  
 Material: Backrest: Polypropylene, Seat: Camira/Synergy or Sørensen/Spectrum Leather; Legs: Painted and Lacquered Oak  
 Production time: 2 weeks



1401060  
Synergy Black



1401061  
Spectrum Leather  
Black

## HYG CHAIR WOOD

Design: Simon Legald, 2021  
 Duty Code: 9401690000  
 Made in: Denmark

Construction: A shell of high-strength polypropylene is mounted with four screws and cups to a wooden base. The Hyg chair wood is available with front or full upholstery following the shell color. The Hyg chair wood is delivered fully assembled.

Maintenance: Polypropylene shell: Clean with a damp cloth. Textile: Clean with textile or upholstery cleaner. Leather: Clean with a damp cloth. Use warm water with soap flakes. Frequent vacuuming with a soft fitting is recommended for both textile and leather to preserve color and appearance.

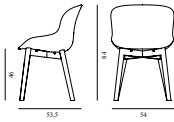

### Hyg Chair Oak

Colli: 1  
 Size & Weight: H: 84 x W: 54 x D: 53,5 x SH: 46 cm - 7,4 kg  
 Packing: Brown Box - H: 86 x L: 57,5 x D: 56 cm - 8,9 kg  
 M3: 0,2769  
 Material: Shell: Polypropylene. Legs: Lacquered oak.  
 Production time: 2 weeks



604462  
White



604463  
Grey



604464  
Black



604465  
Olive



604466  
Sand

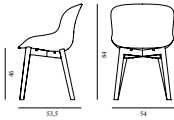

### Hyg Chair Black Oak

Colli: 1  
 Size & Weight: H: 84 x W: 54 x D: 53,5 x SH: 46 cm - 7,4 kg  
 Packing: Brown Box - H: 86 x L: 57,5 x D: 56 cm - 8,9 kg  
 M3: 0,2769  
 Material: Shell: Polypropylene. Legs: Painted and lacquered oak.  
 Production time: 2 weeks



604467  
White



604468  
Grey



604469  
Black



604470  
Olive



604471  
Sand

# HYG CHAIR FRONT UPHOLSTERY WOOD

Design: Simon Legald, 2021  
 Duty Code: 9401610000  
 Made in: Denmark  
 Price Groups: 1) Oceanic, Aquarius  
 2) Remix, Main Line Flax, Synergy  
 3) Canvas, Yoredale  
 4) Steelcut Trio, City Velvet  
 5) Divina, Divina MD, Divina Melange, Hallingdal, Fiord  
 6) Zero, Vidar  
 7) Elle, Ultra Læder

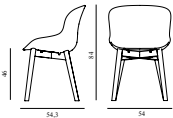

## Hyg Chair Front Upholstery White & Oak

Colli: 1  
 Size & Weight: H: 84 x W: 54 x D: 53,5 x SH: 46 cm - 7,6 kg  
 Packing: Brown Box - H: 86 x L: 57,5 x D: 56 cm - 9,1 kg  
 Material: Shell: Polypropylene with PU foam and front upholstery. Legs: Lacquered oak, Upholstery: See price groups.  
 Production time: 5 weeks

708421  
 Group 1

708422  
 Group 2

708423  
 Group 3

708424  
 Group 4

708425  
 Group 5

708426  
 Group 6

708427  
 Group 7

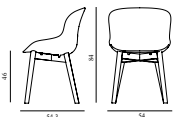

## Hyg Chair Front Upholstery Grey & Oak

Colli: 1  
 Size & Weight: H: 84 x W: 54 x D: 53,5 x SH: 46 cm - 7,6 kg  
 Packing: Brown Box - H: 86 x L: 57,5 x D: 56 cm - 9,1 kg  
 Material: Shell: Polypropylene with PU foam and front upholstery. Legs: Lacquered oak, Upholstery: See price groups.  
 Production time: 5 weeks

708431  
 Group 1

708432  
 Group 2

708433  
 Group 3

708434  
 Group 4

708435  
 Group 5

708436  
 Group 6

708437  
 Group 7



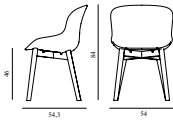

### Hyg Chair Front Upholstery Black & Oak

Colli: 1  
 Size & Weight: H: 84 x W: 54 x D: 53,5 x SH: 46 cm - 7,6 kg  
 Packing: Brown Box - H: 86 x L: 57,5 x D: 56 cm - 9,1 kg  
 Material: Shell: Polypropylene with PU foam and front upholstery. Legs: Lacquered oak, Upholstery: See price groups.  
 Production time: 5 weeks

708441  
 Group 1

708442  
 Group 2

708443  
 Group 3

708444  
 Group 4

708445  
 Group 5

708446  
 Group 6

708447  
 Group 7

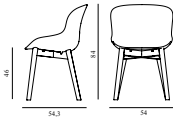

### Hyg Chair Front Upholstery Olive & Oak

Colli: 1  
 Size & Weight: H: 84 x W: 54 x D: 53,5 x SH: 46 cm - 7,6 kg  
 Packing: Brown Box - H: 86 x L: 57,5 x D: 56 cm - 9,1 kg  
 Material: Shell: Polypropylene with PU foam and front upholstery. Legs: Lacquered oak, Upholstery: See price groups.  
 Production time: 5 weeks

708451  
 Group 1

708452  
 Group 2

708453  
 Group 3

708454  
 Group 4

708455  
 Group 5

708456  
 Group 6

708457  
 Group 7

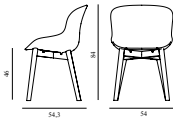

### Hyg Chair Front Upholstery Sand & Oak

Colli: 1  
 Size & Weight: H: 84 x W: 54 x D: 53,5 x SH: 46 cm - 7,6 kg  
 Packing: Brown Box - H: 86 x L: 57,5 x D: 56 cm - 9,1 kg  
 Material: Shell: Polypropylene with PU foam and front upholstery. Legs: Lacquered oak, Upholstery: See price groups.  
 Production time: 5 weeks

708461  
Group 1

708462  
Group 2

708463  
Group 3

708464  
Group 4

708465  
Group 5

708466  
Group 6

708467  
Group 7

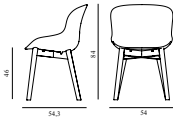

### Hyg Chair Front Upholstery White & Black Oak

Colli: 1  
 Size & Weight: H: 84 x W: 54 x D: 53,5 x SH: 46 cm - 7,6 kg  
 Packing: Brown Box - H: 86 x L: 57,5 x D: 56 cm - 9,1 kg  
 Material: Shell: Polypropylene with PU foam and front upholstery. Legs: Painted and lacquered oak, Upholstery: See price groups.  
 Production time: 5 weeks

708471  
Group 1

708472  
Group 2

708473  
Group 3

708474  
Group 4

708475  
Group 5

708476  
Group 6

708477  
Group 7

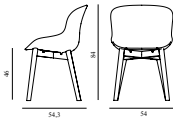

### Hyg Chair Front Upholstery Grey & Black Oak

Colli: 1  
 Size & Weight: H: 84 x W: 54 x D: 53,5 x SH: 46 cm - 7,6 kg  
 Packing: Brown Box - H: 86 x L: 57,5 x D: 56 cm - 9,1 kg  
 Material: Shell: Polypropylene with PU foam and front upholstery. Legs: Painted and lacquered oak, Upholstery: See price groups.  
 Production time: 5 weeks

708481  
Group 1

708482  
Group 2

708483  
Group 3

708484  
Group 4

708485  
Group 5

708486  
Group 6

708487  
Group 7

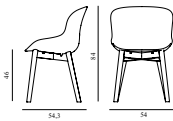

### Hyg Chair Front Upholstery Black & Black Oak

Colli: 1  
 Size & Weight: H: 84 x W: 54 x D: 53,5 x SH: 46 cm - 7,6 kg  
 Packing: Brown Box - H: 86 x L: 57,5 x D: 56 cm - 9,1 kg  
 Material: Shell: Polypropylene with PU foam and front upholstery. Legs: Painted and lacquered oak, Upholstery: See price groups.  
 Production time: 5 weeks

708491  
Group 1

708492  
Group 2

708493  
Group 3

708494  
Group 4

708495  
Group 5

708496  
Group 6

708497  
Group 7

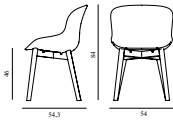

### Hyg Chair Front Upholstery Olive & Black Oak

Colli: 1  
 Size & Weight: H: 84 x W: 54 x D: 53,5 x SH: 46 cm - 7,6 kg  
 Packing: Brown Box - H: 86 x L: 57,5 x D: 56 cm - 9,1 kg  
 Material: Shell: Polypropylene with PU foam and front upholstery. Legs: Painted and lacquered oak, Upholstery: See price groups.  
 Production time: 5 weeks

708501  
Group 1

708502  
Group 2

708503  
Group 3

708504  
Group 4

708505  
Group 5

708506  
Group 6

708507  
Group 7

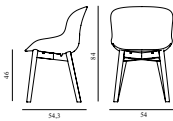

### Hyg Chair Front Upholstery Sand & Black Oak

Colli: 1  
 Size & Weight: H: 84 x W: 54 x D: 53,5 x SH: 46 cm - 7,6 kg  
 Packing: Brown Box - H: 86 x L: 57,5 x D: 56 cm - 9,1 kg  
 Material: Shell: Polypropylene with PU foam and front upholstery. Legs: Painted and lacquered oak, Upholstery: See price groups.  
 Production time: 5 weeks

708511  
Group 1

708512  
Group 2

708513  
Group 3

708514  
Group 4

708515  
Group 5

708516  
Group 6

708517  
Group 7

# HYG CHAIR FULL UPHOLSTERY WOOD

Design: Simon Legald, 2021

Duty Code: 9401610000

Made in: Denmark

- Price Groups:
- 1) Oceanic, Aquarius
  - 2) Remix, Main Line Flax, Synergy
  - 3) Canvas, Yoredale
  - 4) Steelcut Trio, City Velvet
  - 5) Divina, Divina MD, Divina Melange, Hallingdal, Fiord
  - 6) Zero, Vidar
  - 7) Elle, Ultra Læder

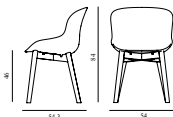

## Hyg Chair Full Upholstery Oak

Coll: I  
Size & Weight: H: 84 x W: 54 x D: 53,5 x SH: 46 cm - 7,8 kg  
Packing: Brown Box - H: 86 x L: 57,5 x D: 56 cm - 9,3 kg  
Material: Shell: Polypropylene with PU foam and full upholstery. Legs: Lacquered oak, Upholstery: See price groups.  
Production time: 2 weeks

708521  
Group 1

708522  
Group 2

708523  
Group 3

708524  
Group 4

708525  
Group 5

708526  
Group 6

708527  
Group 7

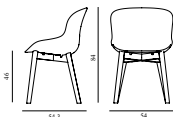

## Hyg Chair Full Upholstery Black Oak

Coll: I  
Size & Weight: H: 84 x W: 54 x D: 53,5 x SH: 46 cm - 7,8 kg  
Packing: Brown Box - H: 86 x L: 57,5 x D: 56 cm - 9,3 kg  
Material: Shell: Polypropylene with PU foam and full upholstery. Legs: Painted and lacquered oak, Upholstery: See price groups.  
Production time: 2 weeks

708531  
Group 1

708532  
Group 2

708533  
Group 3

708534  
Group 4

708535  
Group 5

708536  
Group 6

708537  
Group 7

# HYG COMFORT CHAIR FULL UPHOLSTERY WOOD

Design: Simon Legald, 2022  
 Duty Code: 9401610000  
 Made in: Denmark  
 Price Groups: 1) Oceanic, Aquarius  
 2) Remix, Main Line Flax, Synergy  
 3) Canvas, Yoredale  
 4) Steelcut Trio, City Velvet  
 5) Divina, Divina MD, Divina Melange, Hallingdal, Fiord  
 6) Zero, Vidar  
 7) Elle, Ultra Læder

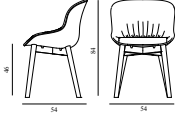

## Hyg Comfort Chair Full Upholstery Oak

Coll: I  
 Size & Weight: H: 84 x W: 54 x D: 54 x SH: 46 cm - 7,5 kg  
 Packing: Brown Box - H: 86 x L: 57,5 x D: 56 cm  
 Material: Shell: Polypropylene with molded soft PU foam and full upholstery. Legs: Lacquered oak, Upholstery: See price groups.  
 Production time: 5 weeks

708541  
Group 1

708542  
Group 2

708543  
Group 3

708544  
Group 4

708545  
Group 5

708546  
Group 6

708547  
Group 7

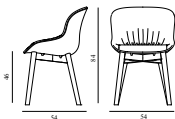

## Hyg Comfort Chair Full Upholstery Black Oak

Size & Weight: H: 84 x W: 54 x D: 54 x SH: 46 cm - 7,5 kg  
 Packing: Brown Box - H: 86 x L: 57,5 x D: 56 cm  
 Material: Shell: Polypropylene with molded soft PU foam and full upholstery. Legs: Painted and lacquered oak, Upholstery: See price groups.  
 Production time: 5 weeks

708551  
Group 1

708552  
Group 2

708553  
Group 3

708554  
Group 4

708555  
Group 5

708556  
Group 6

708557  
Group 7

## HYG CHAIR STEEL

Design: Simon Legald, 2019  
 Duty Code: 9401790000  
 Made in: Denmark  
 Construction: Pressed Polypropylen shell attached with 4 screws and cups to steel frame. Hyg is delivered fully assembled.  
 Maintenance: Clean with damp cloth.

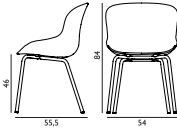

### Hyg Chair Steel

Colli: 1  
 Size & Weight: H: 84 x W: 54 x D: 55,5 x SH: 46 cm - 6,2 kg  
 Packing: Brown Box - H: 86 x L: 57,5 x D: 56 cm - 8,6 kg  
 Material: Shell: Polypropylene, Legs: Powder Coated Steel  
 Production time: 2 weeks

 603872 White	 603873 Grey	 603874 Black	 603875 Olive
			 603876 Sand

## HYG CHAIR FRONT UPHOLSTERY STEEL

Design: Simon Legald, 2019  
 Duty Code: 9401710000  
 Made in: Denmark  
 Price Groups: 1) Oceanic, Aquarius  
 2) Remix, Main Line Flax, Synergy  
 3) Canvas, Yoredale  
 4) Steelcut Trio, City Velvet  
 5) Divina, Divina MD, Divina Melange, Hallingdal, Fiord  
 6) Zero, Vidar  
 7) Elle, Ultra Læder

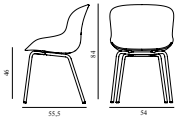

### Hyg Chair Front Upholstery White & White Steel

Colli: 1  
 Size & Weight: H: 84 x W: 54 x D: 55,5 x SH: 46 cm - 6,7 kg  
 Packing: Brown Box - H: 86 x L: 57,5 x D: 56 cm - 9,1 kg  
 Material: Shell: Polypropylene and front upholstery. Legs: Powder Coated Steel, Upholstery: See price groups  
 Production time: 5 weeks

708561 Group 1
708562 Group 2
708563 Group 3
708564 Group 4
708565 Group 5
708566 Group 6
708567 Group 7

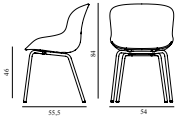

**Hyg Chair Front Upholstery Grey & Grey Steel**

Colli: 1  
 Size & Weight: H: 84 x W: 54 x D: 55,5 x SH: 46 cm - 6,7 kg  
 Packing: Brown Box - H: 86 x L: 57,5 x D: 56 cm - 9,1 kg  
 Material: Shell: Polypropylene and front upholstery. Legs: Powder Coated Steel, Upholstery: See price groups  
 Production time: 5 weeks

708571  
 Group 1

708572  
 Group 2

708573  
 Group 3

708574  
 Group 4

708575  
 Group 5

708576  
 Group 6

708577  
 Group 7

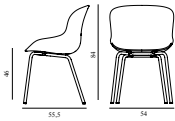

**Hyg Chair Front Upholstery Black & Black Steel**

Colli: 1  
 Size & Weight: H: 84 x W: 54 x D: 55,5 x SH: 46 cm - 6,7 kg  
 Packing: Brown Box - H: 86 x L: 57,5 x D: 56 cm - 9,1 kg  
 Material: Shell: Polypropylene and front upholstery. Legs: Powder Coated Steel, Upholstery: See price groups  
 Production time: 5 weeks

708581  
 Group 1

708582  
 Group 2

708583  
 Group 3

708584  
 Group 4

708585  
 Group 5

708586  
 Group 6

708587  
 Group 7



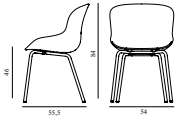

### Hyg Chair Front Upholstery Olive & Olive Steel

Colli: 1  
 Size & Weight: H: 84 x W: 54 x D: 55,5 x SH: 46 cm - 6,7 kg  
 Packing: Brown Box - H: 86 x L: 57,5 x D: 56 cm - 9,1 kg  
 Material: Shell: Polypropylene and front upholstery. Legs: Powder Coated Steel, Upholstery: See price groups  
 Production time: 5 weeks

708591  
Group 1

708592  
Group 2

708593  
Group 3

708594  
Group 4

708595  
Group 5

708596  
Group 6

708597  
Group 7

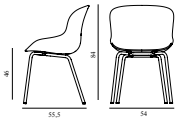

### Hyg Chair Front Upholstery Sand & Sand Steel

Colli: 1  
 Size & Weight: H: 84 x W: 54 x D: 55,5 x SH: 46 cm - 6,7 kg  
 Packing: Brown Box - H: 86 x L: 57,5 x D: 56 cm - 9,1 kg  
 Material: Shell: Polypropylene and front upholstery. Legs: Powder Coated Steel, Upholstery: See price groups  
 Production time: 5 weeks

708601  
Group 1

708602  
Group 2

708603  
Group 3

708604  
Group 4

708605  
Group 5

708606  
Group 6

708607  
Group 7

# HYG CHAIR FULL UPHOLSTERY STEEL

Design: Simon Legald, 2019

Duty Code: 9401710000

Made in: Denmark

Price Groups: 1) Oceanic, Aquarius

2) Remix, Main Line Flax, Synergy

3) Canvas, Yoredale

4) Steelcut Trio, City Velvet

5) Divina, Divina MD, Divina Melange, Hallingdal, Fiord

6) Zero, Vidar

7) Elle, Ultra Læder

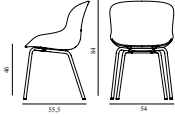

## Hyg Chair Full Upholstery White Steel

Coll: I

Size & Weight: H: 84 x W: 54 x D: 55,5 x SH: 46 cm - 7,5 kg

Packing: Brown Box - H: 86 x L: 57,5 x D: 56 cm - 9,9 kg

Material: Shell: Polypropylene with PU foam and full upholstery. Legs: Powder Coated Steel, Upholstery: See price groups

Production time: 2 weeks

708611  
Group 1

708612  
Group 2

708613  
Group 3

708614  
Group 4

708615  
Group 5

708616  
Group 6

708617  
Group 7

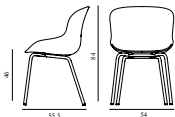

## Hyg Chair Full Upholstery Grey Steel

Coll: I

Size & Weight: H: 84 x W: 54 x D: 55,5 x SH: 46 cm - 7,5 kg

Packing: Brown Box - H: 86 x L: 57,5 x D: 56 cm - 9,9 kg

Material: Shell: Polypropylene with PU foam and full upholstery. Legs: Powder Coated Steel, Upholstery: See price groups

Production time: 2 weeks

708621  
Group 1

708622  
Group 2

708623  
Group 3

708624  
Group 4

708625  
Group 5

708626  
Group 6

708627  
Group 7

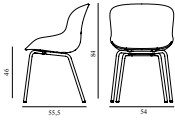

### Hyg Chair Full Upholstery Black Steel

Colli: 1  
 Size & Weight: H: 84 x W: 54 x D: 55,5 x SH: 46 cm - 7,5 kg  
 Packing: Brown Box - H: 86 x L: 57,5 x D: 56 cm - 9,9 kg  
 Material: Shell: Polypropylene with PU foam and full upholstery. Legs: Powder Coated Steel, Upholstery: See price groups  
 Production time: 2 weeks

708631  
 Group 1

708632  
 Group 2

708633  
 Group 3

708634  
 Group 4

708635  
 Group 5

708636  
 Group 6

708637  
 Group 7

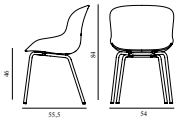

### Hyg Chair Full Upholstery Olive Steel

Colli: 1  
 Size & Weight: H: 84 x W: 54 x D: 55,5 x SH: 46 cm - 7,5 kg  
 Packing: Brown Box - H: 86 x L: 57,5 x D: 56 cm - 9,9 kg  
 Material: Shell: Polypropylene with PU foam and full upholstery. Legs: Powder Coated Steel, Upholstery: See price groups  
 Production time: 2 weeks

708641  
 Group 1

708642  
 Group 2

708643  
 Group 3

708644  
 Group 4

708645  
 Group 5

708646  
 Group 6

708647  
 Group 7

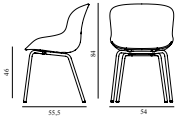

<b>Hyg Chair Full Upholstery Sand Steel</b>	
Colli:	1
Size & Weight:	H: 84 x W: 54 x D: 55,5 x SH: 46 cm - 7,5 kg
Packing:	Brown Box - H: 86 x L: 57,5 x D: 56 cm - 9,9 kg
Material:	Shell: Polypropylene with PU foam and full upholstery. Legs: Powder Coated Steel, Upholstery: See price groups
Production time: 2 weeks	
708651	Group 1
708652	Group 2
708653	Group 3
708654	Group 4
708655	Group 5
708656	Group 6
708657	Group 7

## HYG COMFORT CHAIR FULL UPHOLSTERY STEEL

Design: Simon Legald, 2022  
 Duty Code: 9401710000  
 Made in: Denmark  
 Price Groups: 1) Oceanic, Aquarius  
 2) Remix, Main Line Flax, Synergy  
 3) Canvas, Yoredale  
 4) Steelfut Trio, City Velvet  
 5) Divina, Divina MD, Divina Melange, Hallingdal, Fiord  
 6) Zero, Vidar  
 7) Elle, Ultra Læder

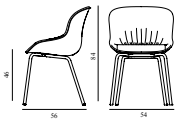

<b>Hyg Comfort Chair Full Upholstery White Steel</b>	
Colli:	1
Size & Weight:	H: 84 x W: 54 x D: 54 x SH: 46 cm - 7,5 kg
Packing:	Brown Box - H: 86 x L: 57,5 x D: 56 cm
M3:	0,2769
Material:	Shell: Polypropylene with molded soft PU foam and full upholstery. Legs: Powder Coated Steel, Upholstery: See price groups
Production time: 2 weeks	
708661	Group 1
708662	Group 2
708663	Group 3
708664	Group 4
708665	Group 5
708666	Group 6
708667	Group 7

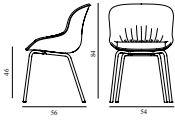

**Hyg Comfort Chair Full Upholstery Grey Steel**

Colli: 1  
 Size & Weight: H: 84 x W: 54 x D: 54 x SH: 46 cm - 7,5 kg  
 Packing: Brown Box - H: 86 x L: 57,5 x D: 56 cm  
 M3: 0,2769  
 Material: Shell: Polypropylene with PU foam and full upholstery. Legs: Powder Coated Steel, Upholstery: See price groups  
 Production time: 2 weeks

708671  
 Group 1

708672  
 Group 2

708673  
 Group 3

708674  
 Group 4

708675  
 Group 5

708676  
 Group 6

708677  
 Group 7

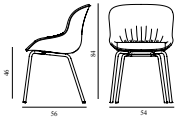

**Hyg Comfort Chair Full Upholstery Black Steel**

Colli: 1  
 Size & Weight: H: 84 x W: 54 x D: 54 x SH: 46 cm - 7,5 kg  
 Packing: Brown Box - H: 86 x L: 57,5 x D: 56 cm  
 M3: 0,2769  
 Material: Shell: Polypropylene with PU foam and full upholstery. Legs: Powder Coated Steel, Upholstery: See price groups  
 Production time: 2 weeks

708681  
 Group 1

708682  
 Group 2

708683  
 Group 3

708684  
 Group 4

708685  
 Group 5

708686  
 Group 6

708687  
 Group 7

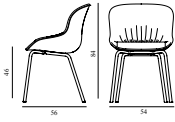

### Hyg Comfort Chair Full Upholstery Olive Steel

Colli: 1  
 Size & Weight: H: 84 x W: 54 x D: 54 x SH: 46 cm - 7,5 kg  
 Packing: Brown Box - H: 86 x L: 57,5 x D: 56 cm  
 M3: 0,2769  
 Material: Shell: Polypropylene with PU foam and full upholstery. Legs: Powder Coated Steel, Upholstery: See price groups  
 Production time: 2 weeks

708691  
 Group 1

708692  
 Group 2

708693  
 Group 3

708694  
 Group 4

708695  
 Group 5

708696  
 Group 6

708697  
 Group 7

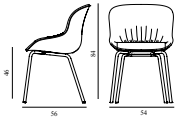

### Hyg Comfort Chair Full Upholstery Sand Steel

Colli: 1  
 Size & Weight: H: 84 x W: 54 x D: 54 x SH: 46 cm - 7,5 kg  
 Packing: Brown Box - H: 86 x L: 57,5 x D: 56 cm  
 M3: 0,2769  
 Material: Shell: Polypropylene with PU foam and full upholstery. Legs: Powder Coated Steel, Upholstery: See price groups  
 Production time: 2 weeks

708701  
 Group 1

708702  
 Group 2

708703  
 Group 3

708704  
 Group 4

708705  
 Group 5

708706  
 Group 6

708707  
 Group 7



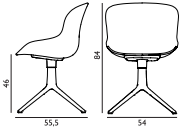

# HYG CHAIR SWIVEL 4L

Design: Simon Legald, 2019  
 Duty Code: 9401790000  
 Made in: Denmark  
 Construction: Pressed Polypropylen shell attached with 4 screws and cups to steel frame. Hyg is delivered fully assembled.  
 Maintenance: Clean with damp cloth.



## Hyg Chair Swivel 4L Alu

Coll: 1  
 Size & Weight: H: 84 x W: 54 x D: 55,5 x SH: 46 cm - 9,5 kg  
 Packing: Brown Box - H: 86 x L: 57,5 x D: 56 cm - 11,9 kg  
 Material: Shell: Polypropylene, Legs: Aluminum  
 Production time: 2 weeks

 603907 White	 603908 Grey	 603909 Black	 603910 Olive
			 603911 Sand

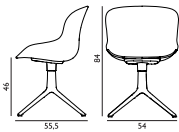

## Hyg Chair Swivel 4L Black Alu

Coll: 1  
 Size & Weight: H: 84 x W: 54 x D: 55,5 x SH: 46 cm - 9,5 kg  
 Packing: Brown Box - H: 86 x L: 57,5 x D: 56 cm - 11,9 kg  
 Material: Shell: Polypropylene, Legs: Aluminum  
 Production time: 2 weeks

 603912 White	 603913 Grey	 603914 Black	 603915 Olive
			 603916 Sand

# HYG CHAIR SWIVEL 4L FRONT UPHOLSTERY

Design: Simon Legald, 2019  
 Duty Code: 9401710000  
 Made in: Denmark  
 Price Groups: 1) Oceanic, Aquarius  
 2) Remix, Main Line Flax, Synergy  
 3) Canvas, Yoredale  
 4) Steelcut Trio, City Velvet  
 5) Divina, Divina MD, Divina Melange, Hallingdal, Fiord  
 6) Zero, Vidar  
 7) Elle, Ultra Læder

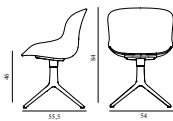

## Hyg Chair Swivel 4L Front Upholstery White & Alu

Coll: 1  
 Size & Weight: H: 84 x W: 54 x D: 55,5 x SH: 46 cm - 10,4 kg  
 Packing: Brown Box - H: 86 x L: 56 x D: 57,5 cm - 12,8 kg  
 Material: Shell: Polypropylene and front upholstery. Legs: Aluminium,  
 Upholstery: See price groups  
 Production time: 5 weeks

708711  
 Group 1

708712  
 Group 2

708713  
 Group 3

708714  
 Group 4

708715  
 Group 5

708716  
 Group 6

708717  
 Group 7

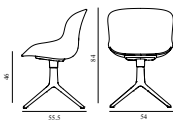

## Hyg Chair Swivel 4L Front Upholstery Grey & Alu

Coll: 1  
 Size & Weight: H: 84 x W: 54 x D: 55,5 x SH: 46 cm - 10,4 kg  
 Packing: Brown Box - H: 86 x L: 56 x D: 57,5 cm - 12,8 kg  
 Material: Shell: Polypropylene and front upholstery. Legs: Aluminium,  
 Upholstery: See price groups  
 Production time: 5 weeks

708721  
 Group 1

708722  
 Group 2

708723  
 Group 3

708724  
 Group 4

708725  
 Group 5

708726  
 Group 6

708727  
 Group 7



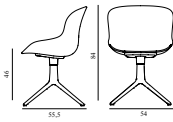

**Hyg Chair Swivel 4L Front Upholstery Black & Alu**

Colli: 1  
 Size & Weight: H: 84 x W: 54 x D: 55,5 x SH: 46 cm - 10,4 kg  
 Packing: Brown Box - H: 86 x L: 56 x D: 57,5 cm - 12,8 kg  
 Material: Shell: Polypropylene and front upholstery. Legs: Aluminium,  
 Upholstery: See price groups  
 Production time: 5 weeks

708731  
 Group 1

708732  
 Group 2

708733  
 Group 3

708734  
 Group 4

708735  
 Group 5

708736  
 Group 6

708737  
 Group 7

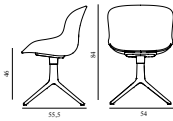

**Hyg Chair Swivel 4L Front Upholstery Olive & Alu**

Colli: 1  
 Size & Weight: H: 84 x W: 54 x D: 55,5 x SH: 46 cm - 10,4 kg  
 Packing: Brown Box - H: 86 x L: 56 x D: 57,5 cm - 12,8 kg  
 Material: Shell: Polypropylene and front upholstery. Legs: Aluminium,  
 Upholstery: See price groups  
 Production time: 5 weeks

708741  
 Group 1

708742  
 Group 2

708743  
 Group 3

708744  
 Group 4

708745  
 Group 5

708746  
 Group 6

708747  
 Group 7

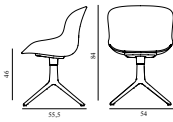

**Hyg Chair Swivel 4L Front Upholstery Sand & Alu**

Colli: 1  
 Size & Weight: H: 84 x W: 54 x D: 55,5 x SH: 46 cm - 10,4 kg  
 Packing: Brown Box - H: 86 x L: 56 x D: 57,5 cm - 12,8 kg  
 Material: Shell: Polypropylene and front upholstery. Legs: Aluminium,  
 Upholstery: See price groups  
 Production time: 5 weeks

708751  
 Group 1

708752  
 Group 2

708753  
 Group 3

708754  
 Group 4

708755  
 Group 5

708756  
 Group 6

708757  
 Group 7

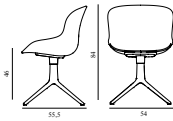

**Hyg Chair Swivel 4L Front Upholstery White & Black Alu**

Colli: 1  
 Size & Weight: H: 84 x W: 54 x D: 55,5 x SH: 46 cm - 10,4 kg  
 Packing: Brown Box - H: 86 x L: 56 x D: 57,5 cm - 12,8 kg  
 Material: Shell: Polypropylene and front upholstery. Legs: Black aluminium,  
 Upholstery: See price groups  
 Production time: 5 weeks

708761  
 Group 1

708762  
 Group 2

708763  
 Group 3

708764  
 Group 4

708765  
 Group 5

708766  
 Group 6

708767  
 Group 7

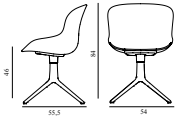

**Hyg Chair Swivel 4L Front Upholstery Grey & Black Alu**

Colli: 1  
 Size & Weight: H: 84 x W: 54 x D: 55,5 x SH: 46 cm - 10,4 kg  
 Packing: Brown Box - H: 86 x L: 56 x D: 57,5 cm - 12,8 kg  
 Material: Shell: Polypropylene and front upholstery. Legs: Black aluminium,  
 Upholstery: See price groups  
 Production time: 5 weeks

708771  
 Group 1

708772  
 Group 2

708773  
 Group 3

708774  
 Group 4

708775  
 Group 5

708776  
 Group 6

708777  
 Group 7

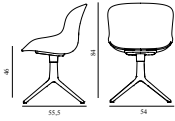

**Hyg Chair Swivel 4L Front Upholstery Black & Black Alu**

Colli: 1  
 Size & Weight: H: 84 x W: 54 x D: 55,5 x SH: 46 cm - 10,4 kg  
 Packing: Brown Box - H: 86 x L: 56 x D: 57,5 cm - 12,8 kg  
 Material: Shell: Polypropylene and front upholstery. Legs: Black aluminium,  
 Upholstery: See price groups  
 Production time: 5 weeks

708781  
 Group 1

708782  
 Group 2

708783  
 Group 3

708784  
 Group 4

708785  
 Group 5

708786  
 Group 6

708787  
 Group 7



**Hyg Chair Swivel 4L Front Upholstery Olive & Black Alu**

Colli: 1  
 Size & Weight: H: 84 x W: 54 x D: 55,5 x SH: 46 cm - 10,4 kg  
 Packing: Brown Box - H: 86 x L: 56 x D: 57,5 cm - 12,8 kg  
 Material: Shell: Polypropylene and front upholstery. Legs: Black aluminium,  
 Upholstery: See price groups  
 Production time: 5 weeks

708791  
 Group 1

708792  
 Group 2

708793  
 Group 3

708794  
 Group 4

708795  
 Group 5

708796  
 Group 6

708797  
 Group 7

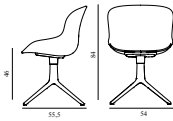

**Hyg Chair Swivel 4L Front Upholstery Sand & Black Alu**

Colli: 1  
 Size & Weight: H: 84 x W: 54 x D: 55,5 x SH: 46 cm - 10,4 kg  
 Packing: Brown Box - H: 86 x L: 56 x D: 57,5 cm - 12,8 kg  
 Material: Shell: Polypropylene and front upholstery. Legs: Black aluminium,  
 Upholstery: See price groups  
 Production time: 5 weeks

708801  
 Group 1

708802  
 Group 2

708803  
 Group 3

708804  
 Group 4

708805  
 Group 5

708806  
 Group 6

708807  
 Group 7

# HYG CHAIR SWIVEL 4L FULL UPHOLSTERY

Design: Simon Legald, 2019  
 Duty Code: 9401710000  
 Made in: Denmark  
 Price Groups: 1) Oceanic, Aquarius  
 2) Remix, Main Line Flax, Synergy  
 3) Canvas, Yoredale  
 4) Steelcut Trio, City Velvet  
 5) Divina, Divina MD, Divina Melange, Hallingdal, Fiord  
 6) Zero, Vidar  
 7) Elle, Ultra Læder



## Hyg Chair Swivel 4L Full Upholstery Alu

Colli: 1  
 Size & Weight: H: 84 x W: 54 x D: 55,5 x SH: 46 cm - 11,2 kg  
 Packing: Brown Box - H: 86 x L: 57,5 x D: 56 cm - 13,6 kg  
 Material: Shell: Polypropylene and full upholstery. Legs: Aluminium,  
 Upholstery: See price groups  
 Production time: 5 weeks

708811  
 Group 1

708812  
 Group 2

708813  
 Group 3

708814  
 Group 4

708815  
 Group 5

708816  
 Group 6

708817  
 Group 7

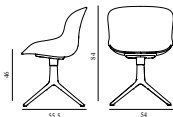

## Hyg Chair Swivel 4L Full Upholstery Black Alu

Colli: 1  
 Size & Weight: H: 84 x W: 54 x D: 55,5 x SH: 46 cm - 11,2 kg  
 Packing: Brown Box - H: 86 x L: 57,5 x D: 56 cm - 13,6 kg  
 Material: Shell: Polypropylene and full upholstery. Legs: Black aluminium,  
 Upholstery: See price groups  
 Production time: 5 weeks

708821  
 Group 1

708822  
 Group 2

708823  
 Group 3

708824  
 Group 4

708825  
 Group 5

708826  
 Group 6

708827  
 Group 7

# HYG COMFORT CHAIR SWIVEL 4L FULL UPHOLSTERY

Design: Simon Legald, 2022  
 Duty Code: 9401710000  
 Made in: Denmark  
 Price Groups: 1) Oceanic, Aquarius  
 2) Remix, Main Line Flax, Synergy  
 3) Canvas, Yoredale  
 4) Steelcut Trio, City Velvet  
 5) Divina, Divina MD, Divina Melange, Hallingdal, Fiord  
 6) Zero, Vidar  
 7) Elle, Ultra Læder

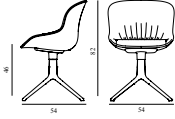

## Hyg Comfort Chair Swivel 4L Full Upholstery Alu

Colli: 1  
 Size & Weight: H: 82 x W: 54 x D: 54 x SH: 46 cm - 9,5 kg  
 Packing: Brown Box - H: 86 x L: 57,5 x D: 56 cm  
 Material: Shell: Polypropylene and full upholstery. Legs: Aluminium,  
 Upholstery: See price groups  
 Production time: 5 weeks

708831  
 Group 1

708832  
 Group 2

708833  
 Group 3

708834  
 Group 4

708835  
 Group 5

708836  
 Group 6

708837  
 Group 7

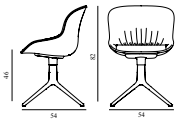

## Hyg Comfort Chair Swivel 4L Full Upholstery Black Alu

Colli: 1  
 Size & Weight: H: 82 x W: 54 x D: 54 x SH: 46 cm - 9,5 kg  
 Packing: Brown Box - H: 84 x L: 54 x D: 56 cm  
 Material: Shell: Polypropylene and full upholstery. Legs: Black aluminium,  
 Upholstery: See price groups  
 Production time: 5 weeks

708841  
 Group 1

708842  
 Group 2

708843  
 Group 3

708844  
 Group 4

708845  
 Group 5

708846  
 Group 6

708847  
 Group 7

# HYG CHAIR SWIVEL 4W

Design: Simon Legald, 2021

Duty Code: 9401790000

Made in: Denmark

Construction: A shell of high-strength polypropylene is mounted to a swivel base with four wheels. The Hyg chair swivel 4W is available with front or full upholstery following the shell color. The Hyg chair swivel 4W is delivered fully assembled.

Maintenance: Polypropylene shell: Clean with a damp cloth. Textile: Clean with textile or upholstery cleaner. Leather: Clean with a damp cloth. Use warm water with soap flakes. Frequent vacuuming with a soft fitting is recommended for both textile and leather to preserve color and appearance.

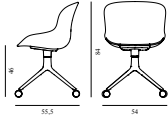

## Hyg Chair Swivel 4W Alu

Coll: 1  
 Size & Weight: H: 84 x W: 54 x D: 55,5 x SH: 46 cm - 10 kg  
 Packing: Brown Box - H: 86 x L: 56 x D: 57,4 cm - 12,4 kg  
 Material: Shell: Polypropylene. Legs: Swivel base in aluminum with four wheels.  
 Production time: 2 weeks

 604568 White	 604569 Grey	 604570 Black	 604571 Sand
			 604572 Olive

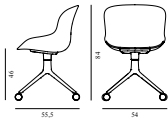

## Hyg Chair Swivel 4W Black Alu

Coll: 1  
 Size & Weight: H: 84 x W: 54 x D: 55,5 x SH: 46 cm - 10 kg  
 Packing: Brown Box - H: 86 x L: 56 x D: 57,4 cm - 12,4 kg  
 Material: Shell: Polypropylene. Legs: Swivel base in powder coated aluminum with four wheels.  
 Production time: 2 weeks

 604574 White	 604575 Grey	 604576 Black	 604577 Sand
			 604578 Olive

# HYG CHAIR SWIVEL 4W FRONT UPHOLSTERY

Design: Simon Legald, 2021  
Duty Code: 9401710000  
Made in: Denmark  
Price Groups: 1) Oceanic, Aquarius  
2) Remix, Main Line Flax, Synergy  
3) Canvas, Yoredale  
4) Steelcut Trio, City Velvet  
5) Divina, Divina MD, Divina Melange, Hallingdal, Fiord  
6) Zero, Vidar  
7) Elle, Ultra Læder

## Hyg Chair Swivel 4W Front Upholstery White & Alu

Colli: 1  
Size & Weight: H: 84 x W: 54 x D: 55,5 x SH: 46 cm - 10 kg  
Packing: Brown Box - H: 86 x L: 56 x D: 57,4 cm - 12,4 kg  
Material: Shell: Polypropylene and front upholstery. Legs: Swivel base in aluminum with four wheels, Upholstery: See price groups  
Production time: 5 weeks

708851  
Group 1

708852  
Group 2

708853  
Group 3

708854  
Group 4

708855  
Group 5

708856  
Group 6

708857  
Group 7

## Hyg Chair Swivel 4W Front Upholstery Grey & Alu

Colli: 1  
Size & Weight: H: 84 x W: 54 x D: 55,5 x SH: 46 cm - 10 kg  
Packing: Brown Box - H: 86 x L: 56 x D: 57,4 cm - 12,4 kg  
Material: Shell: Polypropylene and front upholstery. Legs: Swivel base in aluminum with four wheels, Upholstery: See price groups  
Production time: 5 weeks

708861  
Group 1

708862  
Group 2

708863  
Group 3

708864  
Group 4

708865  
Group 5

708866  
Group 6

708867  
Group 7



**Hyg Chair Swivel 4W Front Upholstery Black & Alu**

Colli: 1  
Size & Weight: H: 84 x W: 54 x D: 55,5 x SH: 46 cm - 10 kg  
Packing: Brown Box - H: 86 x L: 56 x D: 57,4 cm - 12,4 kg  
Material: Shell: Polypropylene and front upholstery. Legs: Swivel base in aluminum with four wheels, Upholstery: See price groups  
Production time: 5 weeks

708871  
Group 1

708872  
Group 2

708873  
Group 3

708874  
Group 4

708875  
Group 5

708876  
Group 6

708877  
Group 7

**Hyg Chair Swivel 4W Front Upholstery Olive & Alu**

Colli: 1  
Size & Weight: H: 84 x W: 54 x D: 55,5 x SH: 46 cm - 10 kg  
Packing: Brown Box - H: 86 x L: 56 x D: 57,4 cm - 12,4 kg  
Material: Shell: Polypropylene and front upholstery. Legs: Swivel base in aluminum with four wheels, Upholstery: See price groups  
Production time: 5 weeks

708881  
Group 1

708882  
Group 2

708883  
Group 3

708884  
Group 4

708885  
Group 5

708886  
Group 6

708887  
Group 7

**Hyg Chair Swivel 4W Front Upholstery Sand & Alu**

Colli: 1  
Size & Weight: H: 84 x W: 54 x D: 55,5 x SH: 46 cm - 10 kg  
Packing: Brown Box - H: 86 x L: 56 x D: 57,4 cm - 12,4 kg  
Material: Shell: Polypropylene and front upholstery. Legs: Swivel base in aluminum with four wheels, Upholstery: See price groups  
Production time: 5 weeks

708891  
Group 1

708892  
Group 2

708893  
Group 3

708894  
Group 4

708895  
Group 5

708896  
Group 6

708897  
Group 7

**Hyg Chair Swivel 4W Front Upholstery White & Black Alu**

Colli: 1  
Size & Weight: H: 84 x W: 54 x D: 55,5 x SH: 46 cm - 10 kg  
Packing: Brown Box - H: 86 x L: 56 x D: 57,4 cm - 12,4 kg  
Material: Shell: Polypropylene and front upholstery. Legs: Swivel base in powder coated aluminum with four wheels, Upholstery: See price groups  
Production time: 5 weeks

708901  
Group 1

708902  
Group 2

708903  
Group 3

708904  
Group 4

708905  
Group 5

708906  
Group 6

708907  
Group 7

### Hyg Chair Swivel 4W Front Upholstery Grey & Black Alu

Colli: 1  
Size & Weight: H: 84 x W: 54 x D: 55,5 x SH: 46 cm - 10 kg  
Packing: Brown Box - H: 86 x L: 56 x D: 57,4 cm - 12,4 kg  
Material: Shell: Polypropylene and front upholstery. Legs: Swivel base  
in powder coated aluminum with four wheels, Upholstery: See  
price groups  
Production time: 5 weeks

708911  
Group 1

708912  
Group 2

708913  
Group 3

708914  
Group 4

708915  
Group 5

708916  
Group 6

708917  
Group 7

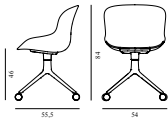

### Hyg Chair Swivel 4W Front Upholstery Black & Black Alu

Colli: 1  
Size & Weight: H: 84 x W: 54 x D: 55,5 x SH: 46 cm - 10 kg  
Packing: Brown Box - H: 86 x L: 56 x D: 57,4 cm - 12,4 kg  
Material: Shell: Polypropylene and front upholstery. Legs: Swivel base  
in powder coated aluminum with four wheels, Upholstery: See  
price groups  
Production time: 5 weeks

708921  
Group 1

708922  
Group 2

708923  
Group 3

708924  
Group 4

708925  
Group 5

708926  
Group 6

708927  
Group 7

<b>Hyg Chair Swivel 4W Front Upholstery Olive &amp; Black Alu</b> Colli: 1 Size & Weight: H: 84 x W: 54 x D: 55,5 x SH: 46 cm - 10 kg Packing: Brown Box - H: 86 x L: 56 x D: 57,4 cm - 12,4 kg Material: Shell: Polypropylene and front upholstery. Legs: Swivel base in powder coated aluminum with four wheels, Upholstery: See price groups Production time: 5 weeks	
708931	Group 1
708932	Group 2
708933	Group 3
708934	Group 4
708935	Group 5
708936	Group 6
708937	Group 7

<b>Hyg Chair Swivel 4W Front Upholstery Sand &amp; Black Alu</b> Colli: 1 Size & Weight: H: 84 x W: 54 x D: 55,5 x SH: 46 cm - 10 kg Packing: Brown Box - H: 86 x L: 56 x D: 57,4 cm - 12,4 kg Material: Shell: Polypropylene and front upholstery. Legs: Swivel base in powder coated aluminum with four wheels, Upholstery: See price groups Production time: 5 weeks	
708941	Group 1
708942	Group 2
708943	Group 3
708944	Group 4
708945	Group 5
708946	Group 6
708947	Group 7

# HYG CHAIR SWIVEL 4W FULL UPHOLSTERY

Design: Simon Legald, 2021  
Duty Code: 9401710000  
Made in: Denmark  
Price Groups: 1) Oceanic, Aquarius  
2) Remix, Main Line Flax, Synergy  
3) Canvas, Yoredale  
4) Steelcut Trio, City Velvet  
5) Divina, Divina MD, Divina Melange, Hallingdal, Fiord  
6) Zero, Vidar  
7) Elle, Ultra Læder

<b>Hyg Chair Swivel 4W Full Upholstery Alu</b>	
Colli:	1
Size & Weight:	H: 84 x W: 54 x D: 55,5 x SH: 46 cm - 10 kg
Packing:	Brown Box - H: 86 x L: 56 x D: 57,4 cm - 12,4 kg
Material:	Shell: Polypropylene with PU foam and full upholstery. Legs: Swivel base in aluminum with four wheels, Upholstery: See price groups
Production time:	5 weeks
708951	Group 1
708952	Group 2
708953	Group 3
708954	Group 4
708955	Group 5
708956	Group 6
708957	Group 7

<b>Hyg Chair Swivel 4W Full Upholstery Black Alu</b>	
Colli:	1
Size & Weight:	H: 84 x W: 54 x D: 55,5 x SH: 46 cm - 10 kg
Packing:	Brown Box - H: 86 x L: 56 x D: 57,4 cm - 12,4 kg
Material:	Shell: Polypropylene with PU foam and full upholstery. Legs: Swivel base in powder coated aluminum with four wheels, Upholstery: See price groups
Production time:	5 weeks
708961	Group 1
708962	Group 2
708963	Group 3
708964	Group 4
708965	Group 5
708966	Group 6
708967	Group 7

# HYG COMFORT CHAIR SWIVEL 4W FULL UPHOLSTERY

Design: Simon Legald, 2022  
Duty Code: 9401710000  
Made in: Denmark  
Price Groups: 1) Oceanic, Aquarius  
2) Remix, Main Line Flax, Synergy  
3) Canvas, Yoredale  
4) Steelcut Trio, City Velvet  
5) Divina, Divina MD, Divina Melange, Hallingdal, Fiord  
6) Zero, Vidar  
7) Elle, Ultra Læder

<b>Hyg Comfort Chair Swivel 4W Full Upholstery Alu</b>
Colli: 1 Size & Weight: H: 82 x W: 55 x D: 54 x SH: 46 cm - 10 kg Packing: Brown Box - H: 86 x L: 56 x D: 57,4 cm Material: Shell: Polypropylene with PU foam and full upholstery. Legs: Swivel base in aluminum with four wheels, Upholstery: See price groups Production time: 5 weeks
708971 Group 1
708972 Group 2
708973 Group 3
708974 Group 4
708975 Group 5
708976 Group 6
708977 Group 7

<b>Hyg Comfort Chair Swivel 4W Full Upholstery Black Alu</b>
Colli: 1 Size & Weight: H: 82 x W: 55 x D: 54 x SH: 46 cm - 10 kg Packing: Brown Box - H: 86 x L: 56 x D: 57,4 cm Material: Shell: Polypropylene with PU foam and full upholstery. Legs: Swivel base in powder coated aluminum with four wheels, Upholstery: See price groups Production time: 5 weeks
708981 Group 1
708982 Group 2
708983 Group 3
708984 Group 4
708985 Group 5
708986 Group 6
708987 Group 7



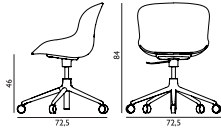

# HYG CHAIR SWIVEL 5W GAS LIFT

Design: Simon Legald, 2019  
 Duty Code: 9401390000  
 Made in: Denmark  
 Construction: Pressed Polypropylen shell attached with 4 screws and cups to steel frame. Hyg is delivered fully assembled.  
 Maintenance: Clean with damp cloth.



## Hyg Chair Swivel 5W Gas Lift Alu



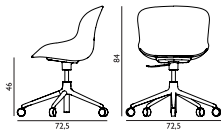

Coll: 1  
 Size & Weight: H: 78/92 x L: 72,5 x D: 72,5 x SH: 38/52 cm - 10,2 kg  
 Packing: Brown Box - H: 80 x L: 69 x D: 66 cm - 13,7 kg  
 Material: Shell: PolypropyleneLegs: Aluminum  
 Production time: 2 weeks

 603983 White	 603984 Grey	 603985 Black	 603986 Olive
			 603987 Sand



## Hyg Chair Swivel 5W Gas Lift Black Alu

Coll: 1  
 Size & Weight: H: 78/92 x L: 72,5 x D: 72,5 x SH: 38/52 cm - 10,2 kg  
 Packing: Brown Box - H: 80 x L: 69 x D: 66 cm - 13,7 kg  
 Material: Shell: Polypropylen (PP) Legs: Aluminum  
 Production time: 2 weeks

 603988 White	 603989 Grey	 603990 Black	 603991 Olive
			 603992 Sand

# HYG CHAIR SWIVEL 5W GAS LIFT FRONT UPHOLSTERY

Design: Simon Legald, 2019  
 Duty Code: 9401390000  
 Made in: Denmark  
 Price Groups: 1) Oceanic, Aquarius  
 2) Remix, Main Line Flax, Synergy  
 3) Canvas, Yoredale  
 4) Steelcut Trio, City Velvet  
 5) Divina, Divina MD, Divina Melange, Hallingdal, Fiord  
 6) Zero, Vidar  
 7) Elle, Ultra Læder

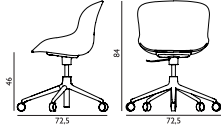

## Hyg Chair Swivel 5W Gas Lift Front Upholstery White & Alu

Colli: 1  
 Size & Weight: H: 78/92 x L: 72,5 x D: 72,5 x SH: 38/52 cm - 10,8 kg  
 Packing: Brown Box - H: 80 x L: 69 x D: 66 cm - 14,3 kg  
 Material: Shell: Polypropylene with PU foam and front upholstery. Legs: Swivel base in aluminum with five wheels, Upholstery: See price groups  
 Production time: 5 weeks

708991  
Group 1

708992  
Group 2

708993  
Group 3

708994  
Group 4

708995  
Group 5

708996  
Group 6

708997  
Group 7

## Hyg Chair Swivel 5W Gas Lift Front Upholstery Grey & Alu

Colli: 1  
 Size & Weight: H: 78/92 x L: 72,5 x D: 72,5 x SH: 38/52 cm - 10,8 kg  
 Packing: Brown Box - H: 80 x L: 69 x D: 66 cm - 14,3 kg  
 Material: Shell: Polypropylene with PU foam and front upholstery. Legs: Swivel base in aluminum with five wheels, Upholstery: See price groups  
 Production time: 5 weeks

709001  
Group 1

709002  
Group 2

709003  
Group 3

709004  
Group 4

709005  
Group 5

709006  
Group 6

709007  
Group 7



**Hyg Chair Swivel 5W Gas Lift Front Upholstery Black & Alu**

Colli: 1  
Size & Weight: H: 78/92 x L: 72,5 x D: 72,5 x SH: 38/52 cm - 10,8 kg  
Packing: Brown Box - H: 80 x L: 69 x D: 66 cm - 14,3 kg  
Material: Shell: Polypropylene with PU foam and front upholstery. Legs: Swivel base in aluminum with five wheels, Upholstery: See price groups  
Production time: 5 weeks

709011  
Group 1

709012  
Group 2

709013  
Group 3

709014  
Group 4

709015  
Group 5

709016  
Group 6

709017  
Group 7

**Hyg Chair Swivel 5W Gas Lift Front Upholstery Olive & Alu**

Colli: 1  
Size & Weight: H: 78/92 x L: 72,5 x D: 72,5 x SH: 38/52 cm - 10,8 kg  
Packing: Brown Box - H: 80 x L: 69 x D: 66 cm - 14,3 kg  
Material: Shell: Polypropylene with PU foam and front upholstery. Legs: Swivel base in aluminum with five wheels, Upholstery: See price groups  
Production time: 5 weeks

709021  
Group 1

709022  
Group 2

709023  
Group 3

709024  
Group 4

709025  
Group 5

709026  
Group 6

709027  
Group 7

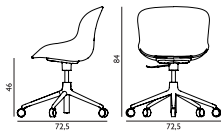

### Hyg Chair Swivel 5W Gas Lift Front Upholstery Sand & Alu

Colli: 1  
 Size & Weight: H: 78/92 x L: 72,5 x D: 72,5 x SH: 38/52 cm - 10,8 kg  
 Packing: Brown Box - H: 80 x L: 69 x D: 66 cm - 14,3 kg  
 Material: Shell: Polypropylene with PU foam and front upholstery. Legs: Swivel base in aluminum with five wheels, Upholstery: See price groups  
 Production time: 5 weeks

709031  
 Group 1

709032  
 Group 2

709033  
 Group 3

709034  
 Group 4

709035  
 Group 5

709036  
 Group 6

709037  
 Group 7

### Hyg Chair Swivel 5W Gas Lift Front Upholstery White & Black Alu

Colli: 1  
 Size & Weight: H: 78/92 x L: 72,5 x D: 72,5 x SH: 38/52 cm - 10,8 kg  
 Packing: Brown Box - H: 80 x L: 69 x D: 66 cm - 14,3 kg  
 Material: Shell: Polypropylene with PU foam and front upholstery. Legs: Swivel base in powder coated aluminum with five wheels, Upholstery: See price groups  
 Production time: 5 weeks

709041  
 Group 1

709042  
 Group 2

709043  
 Group 3

709044  
 Group 4

709045  
 Group 5

709046  
 Group 6

709047  
 Group 7

**Hyg Chair Swivel 5W Gas Lift Front Upholstery Grey & Black Alu**

Colli: 1  
Size & Weight: H: 78/92 x L: 72,5 x D: 72,5 x SH: 38/52 cm - 10,8 kg  
Packing: Brown Box - H: 80 x L: 69 x D: 66 cm - 14,3 kg  
Material: Shell: Polypropylene with PU foam and front upholstery. Legs: Swivel base in powder coated aluminum with five wheels, Upholstery: See price groups  
Production time: 5 weeks

709051  
Group 1

709052  
Group 2

709053  
Group 3

709054  
Group 4

709055  
Group 5

709056  
Group 6

709057  
Group 7

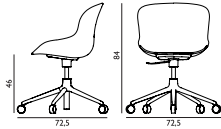

**Hyg Chair Swivel 5W Gas Lift Front Upholstery Black & Black Alu**

Colli: 1  
Size & Weight: H: 78/92 x L: 72,5 x D: 72,5 x SH: 38/52 cm - 10,8 kg  
Packing: Brown Box - H: 80 x L: 69 x D: 66 cm - 14,3 kg  
Material: Shell: Polypropylene with PU foam and front upholstery. Legs: Swivel base in powder coated aluminum with five wheels, Upholstery: See price groups  
Production time: 5 weeks

709061  
Group 1

709062  
Group 2

709063  
Group 3

709064  
Group 4

709065  
Group 5

709066  
Group 6

709067  
Group 7

**Hyg Chair Swivel 5W Gas Lift Front Upholstery Olive & Black Alu**

Colli: 1  
Size & Weight: H: 78/92 x L: 72,5 x D: 72,5 x SH: 38/52 cm - 10,8 kg  
Packing: Brown Box - H: 80 x L: 69 x D: 66 cm - 14,3 kg  
Material: Shell: Polypropylene with PU foam and front upholstery. Legs:  
Swivel base in powder coated aluminum with five wheels,  
Upholstery: See price groups  
Production time: 5 weeks

709071  
Group 1

709072  
Group 2

709073  
Group 3

709074  
Group 4

709075  
Group 5

709076  
Group 6

709077  
Group 7

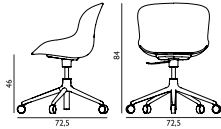

**Hyg Chair Swivel 5W Gas Lift Front Upholstery Sand & Black Alu**

Colli: 1  
Size & Weight: H: 78/92 x L: 72,5 x D: 72,5 x SH: 38/52 cm - 10,8 kg  
Packing: Brown Box - H: 80 x L: 69 x D: 66 cm - 14,3 kg  
Material: Shell: Polypropylene with PU foam and front upholstery. Legs:  
Swivel base in powder coated aluminum with five wheels,  
Upholstery: See price groups  
Production time: 5 weeks

709081  
Group 1

709082  
Group 2

709083  
Group 3

709084  
Group 4

709085  
Group 5

709086  
Group 6

709087  
Group 7

# HYG CHAIR SWIVEL 5W GAS LIFT FULL UPHOLSTERY

Design: Simon Legald, 2019  
Duty Code: 9401390000  
Made in: Denmark  
Price Groups: 1) Oceanic, Aquarius  
2) Remix, Main Line Flax, Synergy  
3) Canvas, Yoredale  
4) Steelcut Trio, City Velvet  
5) Divina, Divina MD, Divina Melange, Hallingdal, Fiord  
6) Zero, Vidar  
7) Elle, Ultra Læder

## Hyg Chair Swivel 5W Gas Lift Full Upholstery Alu

Colli: 1  
Size & Weight: H: 78/92 x L: 72,5 x D: 72,5 x SH: 38/52 cm - 11,5 kg  
Packing: Brown Box - H: 80 x L: 69 x D: 66 cm - 15 kg  
Material: Shell: Polypropylene with PU foam and full upholstery. Legs: Swivel base in aluminum with five wheels, Upholstery: See price groups  
Production time: 5 weeks

709091  
Group 1

709092  
Group 2

709093  
Group 3

709094  
Group 4

709095  
Group 5

709096  
Group 6

709097  
Group 7

## Hyg Chair Swivel 5W Gas Lift Full Upholstery Black Alu

Colli: 1  
Size & Weight: H: 78/92 x L: 72,5 x D: 72,5 x SH: 38/52 cm - 11,5 kg  
Packing: Brown Box - H: 80 x L: 69 x D: 66 cm - 15 kg  
Material: Shell: Polypropylene with PU foam and full upholstery. Legs: Swivel base in powder coated aluminum with five wheels, Upholstery: See price groups  
Production time: 5 weeks

709101  
Group 1

709102  
Group 2

709103  
Group 3

709104  
Group 4

709105  
Group 5

709106  
Group 6

709107  
Group 7

# HYG COMFORT CHAIR SWIVEL 5W GAS LIFT FULL UPHOLSTERY

Design: Simon Legald, 2022

Duty Code: 9401390000

Made in: Denmark

Price Groups: 1) Oceanic, Aquarius

2) Remix, Main Line Flax, Synergy

3) Canvas, Yoredale

4) Steelcut Trio, City Velvet

5) Divina, Divina MD, Divina Melange, Hallingdal, Fiord

6) Zero, Vidar

7) Elle, Ultra Læder

## Hyg Comfort Chair Swivel 5W Gas Lift Full Upholstery Alu

Colli: 1

Size & Weight: H: 82 x W: 72 x D: 68,5 x SH: 46 cm - 11,5 kg

Packing: Brown Box - H: 80 x L: 69 x D: 66 cm - 13,7 kg

Material: Shell: Polypropylene with PU foam and full upholstery. Legs:  
Swivel base in aluminum with five wheels, Upholstery: See price  
groups

Production time: 5 weeks

709111

Group 1

709112

Group 2

709113

Group 3

709114

Group 4

709115

Group 5

709116

Group 6

709117

Group 7

## Hyg Comfort Chair Swivel 5W Gas Lift Full Upholstery Black Alu

Colli: 1

Size & Weight: H: 82 x W: 72 x D: 68,5 x SH: 46 cm - 11,5 kg

Packing: Brown Box - H: 80 x L: 69 x D: 66 cm - 13,7 kg

Material: Shell: Polypropylene with PU foam and full upholstery. Legs:  
Swivel base in powder coated aluminum with five wheels,  
Upholstery: See price groups

Production time: 5 weeks

709121

Group 1

709122

Group 2

709123

Group 3

709124

Group 4

709125

Group 5

709126

Group 6

709127

Group 7

# HYG LOUNGE CHAIR LOW

Design: Simon Legald, 2018  
 Duty Code: 9401610000  
 Made in: Lithuania  
 Price Groups: 1) Oceanic, Aquarius  
 2) Remix, Main Line Flax, Synergy  
 3) Canvas, Yoredale  
 4) Steelcut Trio, City Velvet  
 5) Divina, Divina MD, Divina Melange, Hallingdal, Fiord  
 6) Zero, Vidar  
 7) Elle, Ultra Læder

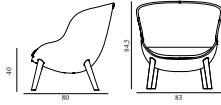

## Hyg Lounge Chair Low Oak

Coll: 1  
 Size & Weight: H: 84,5 x W: 83 x D: 80 x SH: 40 cm - 15 kg  
 Packing: Brown Box - H: 93 x L: 92 x D: 88 cm - 22,2 kg  
 Material: Shell: Hard Molded PU Foam w. Steel Reinforcement, Cushion:  
 Soft Molded PU Foam, Legs: Oak, Upholstery: See price groups  
 Production time: 6 weeks

709131  
 Group 1

709132  
 Group 2

709133  
 Group 3

709134  
 Group 4

709135  
 Group 5

709136  
 Group 6

709137  
 Group 7

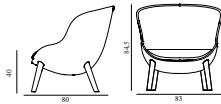

## Hyg Lounge Chair Low Black Oak

Coll: 1  
 Size & Weight: H: 84,5 x W: 83 x D: 80 x SH: 40 cm - 15 kg  
 Packing: Brown Box - H: 93 x L: 92 x D: 88 cm - 22,2 kg  
 Material: Shell: Hard Molded PU Foam w. Steel Reinforcement, Cushion:  
 Soft Molded PU Foam, Legs: Painted and Lacquered Oak,  
 Upholstery: See price groups  
 Production time: 6 weeks

709141  
 Group 1

709142  
 Group 2

709143  
 Group 3

709144  
 Group 4

709145  
 Group 5

709146  
 Group 6

709147  
 Group 7

# HYG LOUNGE CHAIR HIGH

Design: Simon Legald, 2018  
 Duty Code: 9401610000  
 Made in: Lithuania  
 Price Groups: 1) Oceanic, Aquarius  
 2) Remix, Main Line Flax, Synergy  
 3) Canvas, Yoredale  
 4) Steelcut Trio, City Velvet  
 5) Divina, Divina MD, Divina Melange, Hallingdal, Fiord  
 6) Zero, Vidar  
 7) Elle, Ultra Læder

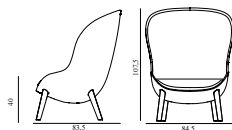

## Hyg Lounge Chair High Oak

Coll: 1  
 Size & Weight: H: 107,5 x W: 84,5 x D: 83,5 x SH: 40 cm - 17 kg  
 Packing: Brown Box - H: 115 x L: 92 x D: 88 cm - 23,4 kg  
 Material: Shell: Hard Molded PU Foam w. Steel Reinforcement, Cushion:  
 Soft Molded PU Foam, Legs: Oak, Upholstery: See price groups  
 Production time: 6 weeks

709151  
 Group 1

709152  
 Group 2

709153  
 Group 3

709154  
 Group 4

709155  
 Group 5

709156  
 Group 6

709157  
 Group 7

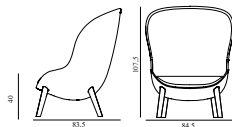

## Hyg Lounge Chair High Black Oak

Coll: 1  
 Size & Weight: H: 107,5 x W: 84,5 x D: 83,5 x SH: 40 cm - 17 kg  
 Packing: Brown Box - H: 115 x L: 92 x D: 88 cm - 23,4 kg  
 Material: Shell: Hard Molded PU Foam w. Steel Reinforcement, Cushion:  
 Soft Molded PU Foam, Legs: Painted and lacquered Oak,  
 Upholstery: See price groups  
 Production time: 6 weeks

709161  
 Group 1

709162  
 Group 2

709163  
 Group 3

709164  
 Group 4

709165  
 Group 5

709166  
 Group 6

709167  
 Group 7



# HYG LOUNGE CHAIR LOW SWIVEL

Design: Simon Legald, 2018  
 Duty Code: 9401710000  
 Made in: Lithuania  
 Price Groups: 1) Oceanic, Aquarius  
 2) Remix, Main Line Flax, Synergy  
 3) Canvas, Yoredale  
 4) Steelcut Trio, City Velvet  
 5) Divina, Divina MD, Divina Melange, Hallingdal, Fiord  
 6) Zero, Vidar  
 7) Elle, Ultra Læder

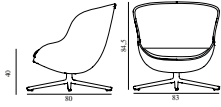

## Hyg Lounge Chair Low Swivel Alu

Coll: 1  
 Size & Weight: H: 84,5 x W: 83 x D: 80 x SH: 40 cm - 18,8 kg  
 Packing: Brown Box - H: 93 x L: 92 x D: 88 cm - 26 kg  
 Material: Shell: Hard Molded PU Foam w. Steel Reinforcement, Cushion: Soft Molded PU Foam, Legs: Aluminum, Upholstery: See price groups  
 Production time: 6 weeks

709171  
 Group 1

709172  
 Group 2

709173  
 Group 3

709174  
 Group 4

709175  
 Group 5

709176  
 Group 6

709177  
 Group 7

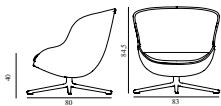

## Hyg Lounge Chair Low Swivel Black Alu

Size & Weight: H: 84,5 x W: 83 x D: 80 x SH: 40 cm - 18,8 kg  
 Material: Shell: Hard Molded PU Foam w. Steel Reinforcement, Cushion: Soft Molded PU Foam, Legs: Powder coated aluminum, Upholstery: See price groups  
 Production time: 6 weeks

709181  
 Group 1

709182  
 Group 2

709183  
 Group 3

709184  
 Group 4

709185  
 Group 5

709186  
 Group 6

709187  
 Group 7

# HYG LOUNGE CHAIR LOW SWIVEL TILT

Design: Simon Legald, 2018  
 Duty Code: 9401710000  
 Made in: Lithuania  
 Price Groups: 1) Oceanic, Aquarius  
 2) Remix, Main Line Flax, Synergy  
 3) Canvas, Yoredale  
 4) Steelcut Trio, City Velvet  
 5) Divina, Divina MD, Divina Melange, Hallingdal, Fiord  
 6) Zero, Vidar  
 7) Elle, Ultra Læder

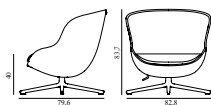

## Hyg Lounge Chair Low Swivel Alu Tilt

Size & Weight: H: 84,5 x W: 83 x D: 80 x SH: 40 cm - 20,5 kg  
 Packing: Brown Box - H: 93 x L: 92 x D: 88 cm - 27,7 kg  
 Material: Shell: Hard Molded PU Foam w. Steel Reinforcement, Cushion:  
 Soft Molded PU Foam, Legs: Aluminum, Upholstery: See price  
 groups  
 Production time: 6 weeks

709191  
 Group 1

709192  
 Group 2

709193  
 Group 3

709194  
 Group 4

709195  
 Group 5

709196  
 Group 6

709197  
 Group 7

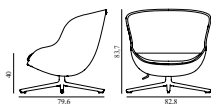

## Hyg Lounge Chair Low Swivel Black Alu Tilt

Size & Weight: H: 84,5 x W: 83 x D: 80 x SH: 40 cm - 20,5 kg  
 Packing: Brown Box - H: 93 x L: 92 x D: 88 cm - 27,7 kg  
 Material: Shell: Hard Molded PU Foam w. Steel Reinforcement, Cushion:  
 Soft Molded PU Foam, Legs: Powder coated aluminum,  
 Upholstery: See price groups  
 Production time: 6 weeks

709201  
 Group 1

709202  
 Group 2

709203  
 Group 3

709204  
 Group 4

709205  
 Group 5

709206  
 Group 6

709207  
 Group 7

# HYG LOUNGE CHAIR HIGH SWIVEL

Design: Simon Legald, 2018  
 Duty Code: 9401710000  
 Made in: Lithuania  
 Price Groups: 1) Oceanic, Aquarius  
 2) Remix, Main Line Flax, Synergy  
 3) Canvas, Yoredale  
 4) Steelcut Trio, City Velvet  
 5) Divina, Divina MD, Divina Melange, Hallingdal, Fiord  
 6) Zero, Vidar  
 7) Elle, Ultra Læder

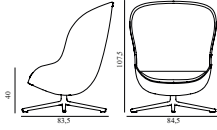

## Hyg Lounge Chair High Swivel Alu

Colli: 1  
 Size & Weight: H: 107,5 x W: 84,5 x D: 83,5 x SH: 40 cm - 20,8 kg  
 Packing: Brown Box - H: 115 x L: 92 x D: 88 cm - 27,2 kg  
 Material: Shell: Hard Molded PU Foam w. Steel Reinforcement, Cushion:  
 Soft Molded PU Foam, Legs: Aluminum, Upholstery: See price  
 groups  
 Production time: 6 weeks

709211  
 Group 1

709212  
 Group 2

709213  
 Group 3

709214  
 Group 4

709215  
 Group 5

709216  
 Group 6

709217  
 Group 7

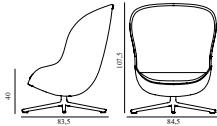

## Hyg Lounge Chair High Swivel Black Alu

Colli: 1  
 Size & Weight: H: 107,5 x W: 84,5 x D: 83,5 x SH: 40 cm - 20,8 kg  
 Packing: Brown Box - H: 115 x L: 92 x D: 88 cm - 27,2 kg  
 Material: Shell: Hard Molded PU Foam w. Steel Reinforcement, Cushion:  
 Soft Molded PU Foam, Legs: Powder coated aluminum,  
 Upholstery: See price groups  
 Production time: 6 weeks

709221  
 Group 1

709222  
 Group 2

709223  
 Group 3

709224  
 Group 4

709225  
 Group 5

709226  
 Group 6

709227  
 Group 7

# HYG LOUNGE CHAIR HIGH SWIVEL TILT

Design: Simon Legald, 2018  
 Duty Code: 9401710000  
 Made in: Lithuania  
 Price Groups: 1) Oceanic, Aquarius  
 2) Remix, Main Line Flax, Synergy  
 3) Canvas, Yoredale  
 4) Steelcut Trio, City Velvet  
 5) Divina, Divina MD, Divina Melange, Hallingdal, Fiord  
 6) Zero, Vidar  
 7) Elle, Ultra Læder

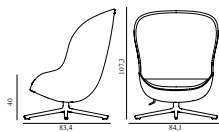

## Hyg Lounge Chair High Swivel Alu Tilt

Coll: 1  
 Size & Weight: H: 107,5 x W: 84,5 x D: 83,5 x SH: 40 cm - 22,5 kg  
 Packing: Brown Box - H: 115 x L: 92 x D: 88 cm - 28,9 kg  
 Material: Shell: Hard Molded PU Foam w. Steel Reinforcement, Cushion:  
 Soft Molded PU Foam, Legs: Aluminum, Upholstery: See price  
 groups  
 Production time: 6 weeks

709231  
 Group 1

709232  
 Group 2

709233  
 Group 3

709234  
 Group 4

709235  
 Group 5

709236  
 Group 6

709237  
 Group 7

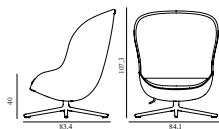

## Hyg Lounge Chair High Swivel Black Alu Tilt

Size & Weight: H: 107,5 x W: 84,5 x D: 83,5 x SH: 40 cm - 22,5 kg  
 Packing: Brown Box - H: 115 x L: 92 x D: 88 cm - 28,9 kg  
 Material: Shell: Hard Molded PU Foam w. Steel Reinforcement, Cushion:  
 Soft Molded PU Foam, Legs: Powder coated aluminum,  
 Upholstery: See price groups  
 Production time: 6 weeks

709241  
 Group 1

709242  
 Group 2

709243  
 Group 3

709244  
 Group 4

709245  
 Group 5

709246  
 Group 6

709247  
 Group 7

# HYG BARSTOOL 65 CM WOOD

Design: Simon Legald, 2019  
 Duty Code: 9401690000  
 Made in: Denmark

Construction: A shell of high-strength polypropylene is mounted with four screws to a wooden base. The Hyg barstool wood is available with front or full upholstery following the shell color. The Hyg barstool wood is delivered fully assembled.

Maintenance: Polypropylene shell: Clean with a damp cloth. Textile: Clean with textile or upholstery cleaner. Leather: Clean with a damp cloth. Use warm water with soap flakes. Frequent vacuuming with a soft fitting is recommended for both textile and leather to preserve color and appearance.

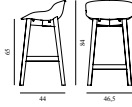

## Hyg Barstool 65 cm Oak

Colli: 1  
 Size & Weight: H: 84 x W: 46,5 x D: 44 x SH: 65 cm - 5,3 kg  
 Packing: Brown Box - H: 86 x L: 48,5 x D: 47 cm - 7,3 kg  
 Material: Shell: Polypropylene. Legs: Lacquered oak.  
 Production time: 2 weeks

 604386 White	 604387 Grey	 604388 Black	 604389 Olive
			 604390 Sand

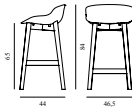

## Hyg Barstool 65 cm Black Oak

Colli: 1  
 Size & Weight: H: 84 x W: 46,5 x D: 44 x SH: 65 cm - 5,3 kg  
 Packing: Brown Box - H: 86 x L: 48,5 x D: 47 cm - 7,3 kg  
 Material: Shell: Polypropylene. Legs: Painted and lacquered oak.  
 Production time: 2 weeks

 604391 White	 604392 Grey	 604393 Black	 604394 Olive
			 604395 Sand

# HYG BARSTOOL 65 CM FRONT UPHOLSTERY WOOD

Design: Simon Legald, 2019  
Duty Code: 9401610000  
Made in: Denmark  
Price Groups: 1) Oceanic, Aquarius  
2) Remix, Main Line Flax, Synergy  
3) Canvas, Yoredale  
4) Steelcut Trio, City Velvet  
5) Divina, Divina MD, Divina Melange, Hallingdal, Fiord  
6) Zero, Vidar  
7) Elle, Ultra Læder

## Hyg Barstool 65 cm Front Upholstery White & Oak

Colli: 1  
Size & Weight: H: 84 x W: 46,5 x D: 44 x SH: 65 cm - 5,4 kg  
Packing: Brown Box - H: 86 x L: 48,5 x D: 47 cm - 7,4 kg  
M3: 0,196  
Material: Shell: Polypropylene with PU foam and front upholstery. Legs:  
Lacquered oak, Upholstery: See price groups.  
Production time: 5 weeks

709251  
Group 1

709252  
Group 2

709253  
Group 3

709254  
Group 4

709255  
Group 5

709256  
Group 6

709257  
Group 7

## Hyg Barstool 65 cm Front Upholstery Grey & Oak

Colli: 1  
Size & Weight: H: 84 x W: 46,5 x D: 44 x SH: 65 cm - 5,4 kg  
Packing: Brown Box - H: 86 x L: 48,5 x D: 47 cm - 7,4 kg  
M3: 0,196  
Material: Shell: Polypropylene with PU foam and front upholstery. Legs:  
Lacquered oak, Upholstery: See price groups.  
Production time: 5 weeks

709261  
Group 1

709262  
Group 2

709263  
Group 3

709264  
Group 4

709265  
Group 5

709266  
Group 6

709267  
Group 7

**Hyg Barstool 65 cm Front Upholstery Black & Oak**

Colli: 1  
Size & Weight: H: 84 x W: 46,5 x D: 44 x SH: 65 cm - 5,4 kg  
Packing: Brown Box - H: 86 x L: 48,5 x D: 47 cm - 7,4 kg  
M3: 0,196  
Material: Shell: Polypropylene with PU foam and front upholstery. Legs:  
Lacquered oak, Upholstery: See price groups.  
Production time: 5 weeks

709271  
Group 1

709272  
Group 2

709273  
Group 3

709274  
Group 4

709275  
Group 5

709276  
Group 6

709277  
Group 7

**Hyg Barstool 65 cm Front Upholstery Olive & Oak**

Colli: 1  
Size & Weight: H: 84 x W: 46,5 x D: 44 x SH: 65 cm - 5,4 kg  
Packing: Brown Box - H: 86 x L: 48,5 x D: 47 cm - 7,4 kg  
M3: 0,196  
Material: Shell: Polypropylene with PU foam and front upholstery. Legs:  
Lacquered oak, Upholstery: See price groups.  
Production time: 5 weeks

709281  
Group 1

709282  
Group 2

709283  
Group 3

709284  
Group 4

709285  
Group 5

709286  
Group 6

709287  
Group 7

**Hyg Barstool 65 cm Front Upholstery Sand & Oak**

Colli: 1  
Size & Weight: H: 84 x W: 46,5 x D: 44 x SH: 65 cm - 5,4 kg  
Packing: Brown Box - H: 86 x L: 48,5 x D: 47 cm - 7,4 kg  
M3: 0,196  
Material: Shell: Polypropylene with PU foam and front upholstery. Legs:  
Lacquered oak, Upholstery: See price groups.  
Production time: 5 weeks

709291  
Group 1

709292  
Group 2

709293  
Group 3

709294  
Group 4

709295  
Group 5

709296  
Group 6

709297  
Group 7

**Hyg Barstool 65 cm Front Upholstery White & Black  
Oak**

Colli: 1  
Size & Weight: H: 84 x W: 46,5 x D: 44 x SH: 65 cm - 5,4 kg  
Packing: Brown Box - H: 86 x L: 48,5 x D: 47 cm - 7,4 kg  
M3: 0,196  
Material: Shell: Polypropylene with PU foam and front upholstery. Legs:  
Painted and lacquered oak, Upholstery: See price groups.  
Production time: 5 weeks

709311  
Group 1

709312  
Group 2

709313  
Group 3

709314  
Group 4

709315  
Group 5

709316  
Group 6

709317  
Group 7



**Hyg Barstool 65 cm Front Upholstery Grey & Black Oak**

Colli: 1  
Size & Weight: H: 84 x W: 46,5 x D: 44 x SH: 65 cm - 5,4 kg  
Packing: Brown Box - H: 86 x L: 48,5 x D: 47 cm - 7,4 kg  
M3: 0,196  
Material: Shell: Polypropylene with PU foam and front upholstery. Legs:  
Painted and lacquered oak, Upholstery: See price groups.  
Production time: 5 weeks

709321  
Group 1

709322  
Group 2

709323  
Group 3

709324  
Group 4

709325  
Group 5

709326  
Group 6

709327  
Group 7

**Hyg Barstool 65 cm Front Upholstery Black & Black Oak**

Colli: 1  
Size & Weight: H: 84 x W: 46,5 x D: 44 x SH: 65 cm - 5,4 kg  
Packing: Brown Box - H: 86 x L: 48,5 x D: 47 cm - 7,4 kg  
M3: 0,196  
Material: Shell: Polypropylene with PU foam and front upholstery. Legs:  
Painted and lacquered oak, Upholstery: See price groups.  
Production time: 5 weeks

709331  
Group 1

709332  
Group 2

709333  
Group 3

709334  
Group 4

709335  
Group 5

709336  
Group 6

709337  
Group 7

**Hyg Barstool 65 cm Front Upholstery Olive & Black Oak**

Colli: 1  
Size & Weight: H: 84 x W: 46,5 x D: 44 x SH: 65 cm - 5,4 kg  
Packing: Brown Box - H: 86 x L: 48,5 x D: 47 cm - 7,4 kg  
M3: 0,196  
Material: Shell: Polypropylene with PU foam and front upholstery. Legs: Painted and lacquered oak, Upholstery: See price groups.  
Production time: 5 weeks

709341  
Group 1

709342  
Group 2

709343  
Group 3

709344  
Group 4

709345  
Group 5

709346  
Group 6

709347  
Group 7

**Hyg Barstool 65 cm Front Upholstery Sand & Black Oak**

Colli: 1  
Size & Weight: H: 84 x W: 46,5 x D: 44 x SH: 65 cm - 5,4 kg  
Packing: Brown Box - H: 86 x L: 48,5 x D: 47 cm - 7,4 kg  
M3: 0,196  
Material: Shell: Polypropylene with PU foam and front upholstery. Legs: Painted and lacquered oak, Upholstery: See price groups.  
Production time: 5 weeks

709351  
Group 1

709352  
Group 2

709353  
Group 3

709354  
Group 4

709355  
Group 5

709356  
Group 6

709357  
Group 7

# HYG BARSTOOL 65 CM FULL UPHOLSTERY WOOD

Design: Simon Legald, 2021  
Duty Code: 9401610000  
Made in: Denmark  
Price Groups: 1) Oceanic, Aquarius  
2) Remix, Main Line Flax, Synergy  
3) Canvas, Yoredale  
4) Steelcut Trio, City Velvet  
5) Divina, Divina MD, Divina Melange, Hallingdal, Fiord  
6) Zero, Vidar  
7) Elle, Ultra Læder

## Hyg Barstool 65 cm Full Upholstery Oak

Colli: 1  
Size & Weight: H: 84 x W: 46,5 x D: 44 x SH: 65 cm - 5,5 kg  
Packing: Brown Box - H: 86 x L: 48,5 x D: 47 cm - 7,5 kg  
Material: Shell: Polypropylene with PU foam and full upholstery. Legs:  
Lacquered oak, Upholstery: See price groups.  
Production time: 5 weeks

709301  
Group 1

709302  
Group 2

709303  
Group 3

709304  
Group 4

709305  
Group 5

709306  
Group 6

709307  
Group 7

## Hyg Barstool 65 cm Full Upholstery Black Oak

Colli: 1  
Size & Weight: H: 84 x W: 46,5 x D: 44 x SH: 65 cm - 5,5 kg  
Packing: Brown Box - H: 86 x L: 48,5 x D: 47 cm - 7,5 kg  
Material: Shell: Polypropylene with PU foam and full upholstery. Legs:  
Painted and lacquered oak, Upholstery: See price groups.  
Production time: 5 weeks

709361  
Group 1

709362  
Group 2

709363  
Group 3

709364  
Group 4

709365  
Group 5

709366  
Group 6

709367  
Group 7

## HYG BARSTOOL 65 CM STEEL

Design: Simon Legald, 2019  
 Duty Code: 9401790000  
 Made in: Denmark  
 Construction: Pressed Polypropylen shell attached with 4 screws and cups to steel frame. Hyg is delivered fully assembled.  
 Maintenance: Clean with damp cloth.

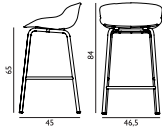

### Hyg Barstool 65 cm Steel

Colli: 1  
 Size & Weight: H: 84 x W: 46,5 x D: 45 x SH: 65 cm - 5,4 kg  
 Packing: Brown Box - H: 86 x L: 48,5 x D: 47 cm - 7,4 kg  
 Material: Shell: Polypropylene Legs: Powder Coated Steel  
 Production time: 2 weeks

 604029 White	 604030 Grey	 604031 Black	 604032 Olive
			 604033 Sand

## HYG BARSTOOL 65 CM FRONT UPHOLSTERY STEEL

Design: Simon Legald, 2019  
 Duty Code: 9401710000  
 Made in: Denmark  
 Price Groups: 1) Oceanic, Aquarius  
 2) Remix, Main Line Flax, Synergy  
 3) Canvas, Yoredale  
 4) Steelcut Trio, City Velvet  
 5) Divina, Divina MD, Divina Melange, Hallingdal, Fiord  
 6) Zero, Vidar  
 7) Elle, Ultra Læder

### Hyg Barstool 65 cm Front Upholstery White & White Steel

Colli: 1  
 Size & Weight: H: 84 x W: 46,5 x D: 45 x SH: 65 cm - 6 kg  
 Packing: Brown Box - H: 86 x L: 48,5 x D: 47 cm - 8 kg  
 Material: Shell: Polypropylene with PU foam and front upholstery. Legs: Powder coated steel, Upholstery: See price groups.  
 Production time: 5 weeks

709371 Group 1
709372 Group 2
709373 Group 3
709374 Group 4
709375 Group 5
709376 Group 6
709377 Group 7

**Hyg Barstool 65 cm Front Upholstery Grey & Grey Steel**

Colli: 1  
Size & Weight: H: 84 x W: 46,5 x D: 45 x SH: 65 cm - 6 kg  
Packing: Brown Box - H: 86 x L: 48,5 x D: 47 cm - 8 kg  
Material: Shell: Polypropylene with PU foam and front upholstery. Legs: Powder coated steel, Upholstery: See price groups.  
Production time: 5 weeks

709381  
Group 1

709382  
Group 2

709383  
Group 3

709384  
Group 4

709385  
Group 5

709386  
Group 6

709387  
Group 7

**Hyg Barstool 65 cm Front Upholstery Black & Black Steel**

Colli: 1  
Size & Weight: H: 84 x W: 46,5 x D: 45 x SH: 65 cm - 6 kg  
Packing: Brown Box - H: 86 x L: 48,5 x D: 47 cm - 8 kg  
Material: Shell: Polypropylene with PU foam and front upholstery. Legs: Powder coated steel, Upholstery: See price groups.  
Production time: 5 weeks

709391  
Group 1

709392  
Group 2

709393  
Group 3

709394  
Group 4

709395  
Group 5

709396  
Group 6

709397  
Group 7

**Hyg Barstool 65 cm Front Upholstery Olive & Olive Steel**

Colli: 1  
Size & Weight: H: 84 x W: 46,5 x D: 45 x SH: 65 cm - 6 kg  
Packing: Brown Box - H: 86 x L: 48,5 x D: 47 cm - 8 kg  
Material: Shell: Polypropylene with PU foam and front upholstery. Legs: Powder coated steel, Upholstery: See price groups.  
Production time: 5 weeks

709401  
Group 1

709402  
Group 2

709403  
Group 3

709404  
Group 4

709405  
Group 5

709406  
Group 6

709407  
Group 7

**Hyg Barstool 65 cm Front Upholstery Sand & Sand Steel**

Colli: 1  
Size & Weight: H: 84 x W: 46,5 x D: 45 x SH: 65 cm - 6 kg  
Packing: Brown Box - H: 86 x L: 48,5 x D: 47 cm - 8 kg  
Material: Shell: Polypropylene with PU foam and front upholstery. Legs: Powder coated steel, Upholstery: See price groups.  
Production time: 5 weeks

709411  
Group 1

709412  
Group 2

709413  
Group 3

709414  
Group 4

709415  
Group 5

709416  
Group 6

709417  
Group 7

# HYG BARSTOOL 65 CM FULL UPHOLSTERY STEEL

Design: Simon Legald, 2019  
Duty Code: 9401710000  
Made in: Denmark  
Price Groups: 1) Oceanic, Aquarius  
2) Remix, Main Line Flax, Synergy  
3) Canvas, Yoredale  
4) Steelcut Trio, City Velvet  
5) Divina, Divina MD, Divina Melange, Hallingdal, Fiord  
6) Zero, Vidar  
7) Elle, Ultra Læder

## Hyg Barstool 65 cm Full Upholstery White Steel

Colli: 1  
Size & Weight: H: 84 x W: 46,5 x D: 45 x SH: 65 cm - 6,2 kg  
Packing: Brown Box - H: 86 x L: 48,5 x D: 47 cm - 8,2 kg  
Material: Shell: Polypropylene with PU foam and full upholstery. Legs: Powder coated steel, Upholstery: See price groups.  
Production time: 5 weeks

709422  
Group 2

709423  
Group 3

709424  
Group 4

709425  
Group 5

709426  
Group 6

709427  
Group 7

## Hyg Barstool 65 cm Full Upholstery Grey Steel

Colli: 1  
Size & Weight: H: 84 x W: 46,5 x D: 45 x SH: 65 cm - 6,2 kg  
Packing: Brown Box - H: 86 x L: 48,5 x D: 47 cm - 8,2 kg  
Material: Shell: Polypropylene with PU foam and full upholstery. Legs: Powder coated steel, Upholstery: See price groups.  
Production time: 5 weeks

709431  
Group 1

709432  
Group 2

709433  
Group 3

709434  
Group 4

709435  
Group 5

709436  
Group 6

709437  
Group 7

**Hyg Barstool 65 cm Full Upholstery Black Steel**

Colli: 1  
Size & Weight: H: 84 x W: 46,5 x D: 45 x SH: 65 cm - 6,2 kg  
Packing: Brown Box - H: 86 x L: 48,5 x D: 47 cm - 8,2 kg  
Material: Shell: Polypropylene with PU foam and full upholstery. Legs:  
Powder coated steel, Upholstery: See price groups.  
Production time: 5 weeks

709441  
Group 1

709442  
Group 2

709443  
Group 3

709444  
Group 4

709445  
Group 5

709446  
Group 6

709447  
Group 7

**Hyg Barstool 65 cm Full Upholstery Olive Steel**

Colli: 1  
Size & Weight: H: 84 x W: 46,5 x D: 45 x SH: 65 cm - 6,2 kg  
Packing: Brown Box - H: 86 x L: 48,5 x D: 47 cm - 8,2 kg  
Material: Shell: Polypropylene with PU foam and full upholstery. Legs:  
Powder coated steel, Upholstery: See price groups.  
Production time: 5 weeks

709451  
Group 1

709452  
Group 2

709453  
Group 3

709454  
Group 4

709455  
Group 5

709456  
Group 6

709457  
Group 7



<p><b>Hyg Barstool 65 cm Full Upholstery Sand Steel</b></p> <p>Colli: 1  Size &amp; Weight: H: 84 x W: 46,5 x D: 45 x SH: 65 cm - 6,2 kg  Packing: Brown Box - H: 86 x L: 48,5 x D: 47 cm - 8,2 kg  Material: Shell: Polypropylene with PU foam and full upholstery. Legs: Powder coated steel, Upholstery: See price groups.  Production time: 5 weeks</p>
709461 Group 1
709462 Group 2
709463 Group 3
709464 Group 4
709465 Group 5
709466 Group 6
709467 Group 7

## HYG BARSTOOL 75 CM WOOD

Design: Simon Legald, 2019  
Duty Code: 9401690000  
Made in: Denmark  
Construction: A shell of high-strength polypropylene is mounted with four screws to a wooden base. The Hyg barstool wood is available with front or full upholstery following the shell color. The Hyg barstool wood is delivered fully assembled.  
Maintenance: Polypropylene shell: Clean with a damp cloth. Textile: Clean with textile or upholstery cleaner. Leather: Clean with a damp cloth. Use warm water with soap flakes. Frequent vacuuming with a soft fitting is recommended for both textile and leather to preserve color and appearance.

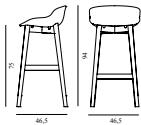

### Hyg Barstool 75 cm Oak

Colli: 1  
Size & Weight: H: 94 x W: 46,5 x D: 46,5 x SH: 75 cm - 5,8 kg  
Packing: Brown Box - H: 96 x L: 49,5 x D: 48,5 cm - 7,8 kg  
Material: Shell: Polypropylene. Legs: Lacquered oak.  
Production time: 2 weeks

 604396 White	 604397 Grey	 604398 Black	 604399 Olive
			 604400 Sand

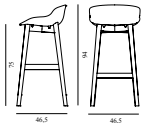

### Hyg Barstool 75 cm Black Oak

Colli: 1  
Size & Weight: H: 94 x W: 46,5 x D: 46,5 x SH: 75 cm - 5,8 kg  
Packing: Brown Box - H: 96 x L: 49,5 x D: 48,5 cm - 7,8 kg  
Material: Shell: Polypropylene. Legs: Painted and lacquered oak.  
Production time: 2 weeks

 604401 White	 604402 Grey	 604403 Black	 604404 Olive
			 604405 Sand

# HYG BARSTOOL 75 CM FRONT UPHOLSTERY WOOD

Design: Simon Legald, 2019  
Duty Code: 9401610000  
Made in: Denmark  
Price Groups: 1) Oceanic, Aquarius  
2) Remix, Main Line Flax, Synergy  
3) Canvas, Yoredale  
4) Steelcut Trio, City Velvet  
5) Divina, Divina MD, Divina Melange, Hallingdal, Fiord  
6) Zero, Vidar  
7) Elle, Ultra Læder

## Hyg Barstool 75 cm Front Upholstery White & Oak

Colli: 1  
Size & Weight: H: 94 x W: 46,5 x D: 46,5 x SH: 75 cm - 5,9 kg  
Packing: Brown Box - H: 96 x L: 49,5 x D: 48,5 cm - 7,9 kg  
Material: Shell: Polypropylene with PU foam and front upholstery. Legs:  
Lacquered oak, Upholstery: See price groups.  
Production time: 5 weeks

709471  
Group 1

709472  
Group 2

709473  
Group 3

709474  
Group 4

709475  
Group 5

709476  
Group 6

709477  
Group 7

## Hyg Barstool 75 cm Front Upholstery Grey & Oak

Colli: 1  
Size & Weight: H: 94 x W: 46,5 x D: 46,5 x SH: 75 cm - 5,9 kg  
Packing: Brown Box - H: 96 x L: 49,5 x D: 48,5 cm - 7,9 kg  
Material: Shell: Polypropylene with PU foam and front upholstery. Legs:  
Lacquered oak, Upholstery: See price groups.  
Production time: 5 weeks

709481  
Group 1

709482  
Group 2

709483  
Group 3

709484  
Group 4

709485  
Group 5

709486  
Group 6

709487  
Group 7

**Hyg Barstool 75 cm Front Upholstery Black & Oak**

Colli: 1  
Size & Weight: H: 94 x W: 46,5 x D: 46,5 x SH: 75 cm - 5,9 kg  
Packing: Brown Box - H: 96 x L: 49,5 x D: 48,5 cm - 7,9 kg  
Material: Shell: Polypropylene with PU foam and front upholstery. Legs:  
Lacquered oak, Upholstery: See price groups.  
Production time: 5 weeks

709491  
Group 1

709492  
Group 2

709493  
Group 3

709494  
Group 4

709495  
Group 5

709496  
Group 6

709497  
Group 7

**Hyg Barstool 75 cm Front Upholstery Olive & Oak**

Colli: 1  
Size & Weight: H: 94 x W: 46,5 x D: 46,5 x SH: 75 cm - 5,9 kg  
Packing: Brown Box - H: 96 x L: 49,5 x D: 48,5 cm - 7,9 kg  
Material: Shell: Polypropylene with PU foam and front upholstery. Legs:  
Lacquered oak, Upholstery: See price groups.  
Production time: 5 weeks

709501  
Group 1

709502  
Group 2

709503  
Group 3

709504  
Group 4

709505  
Group 5

709506  
Group 6

709507  
Group 7

**Hyg Barstool 75 cm Front Upholstery Sand & Oak**

Colli: 1  
Size & Weight: H: 94 x W: 46,5 x D: 46,5 x SH: 75 cm - 5,9 kg  
Packing: Brown Box - H: 96 x L: 49,5 x D: 48,5 cm - 7,9 kg  
Material: Shell: Polypropylene with PU foam and front upholstery. Legs:  
Lacquered oak, Upholstery: See price groups.  
Production time: 5 weeks

709511  
Group 1

709512  
Group 2

709513  
Group 3

709514  
Group 4

709515  
Group 5

709516  
Group 6

709517  
Group 7

**Hyg Barstool 75 cm Front Upholstery White & Black Oak**

Colli: 1  
Size & Weight: H: 94 x W: 46,5 x D: 46,5 x SH: 75 cm - 5,9 kg  
Packing: Brown Box - H: 96 x L: 49,5 x D: 48,5 cm - 7,9 kg  
M3: 0,2305  
Material: Shell: Polypropylene with PU foam and front upholstery. Legs:  
Painted and lacquered oak, Upholstery: See price groups.  
Production time: 5 weeks

709531  
Group 1

709532  
Group 2

709533  
Group 3

709534  
Group 4

709535  
Group 5

709536  
Group 6

709537  
Group 7

**Hyg Barstool 75 cm Front Upholstery Grey & Black Oak**

Colli: 1  
Size & Weight: H: 94 x W: 46,5 x D: 46,5 x SH: 75 cm - 5,9 kg  
Packing: Brown Box - H: 96 x L: 49,5 x D: 48,5 cm - 7,9 kg  
M3: 0,2305  
Material: Shell: Polypropylene with PU foam and front upholstery. Legs:  
Painted and lacquered oak, Upholstery: See price groups.  
Production time: 5 weeks

709541  
Group 1

709542  
Group 2

709543  
Group 3

709544  
Group 4

709545  
Group 5

709546  
Group 6

709547  
Group 7

**Hyg Barstool 75 cm Front Upholstery Black & Black Oak**

Colli: 1  
Size & Weight: H: 94 x W: 46,5 x D: 46,5 x SH: 75 cm - 5,9 kg  
Packing: Brown Box - H: 96 x L: 49,5 x D: 48,5 cm - 7,9 kg  
M3: 0,2305  
Material: Shell: Polypropylene with PU foam and front upholstery. Legs:  
Painted and lacquered oak, Upholstery: See price groups.  
Production time: 5 weeks

709551  
Group 1

709552  
Group 2

709553  
Group 3

709554  
Group 4

709555  
Group 5

709556  
Group 6

709557  
Group 7

**Hyg Barstool 75 cm Front Upholstery Olive & Black Oak**

Colli: 1  
Size & Weight: H: 94 x W: 46,5 x D: 46,5 x SH: 75 cm - 5,9 kg  
Packing: Brown Box - H: 96 x L: 49,5 x D: 48,5 cm - 7,9 kg  
M3: 0,2305  
Material: Shell: Polypropylene with PU foam and front upholstery. Legs: Painted and lacquered oak, Upholstery: See price groups.  
Production time: 5 weeks

709561  
Group 1

709562  
Group 2

709563  
Group 3

709564  
Group 4

709565  
Group 5

709566  
Group 6

709567  
Group 7

**Hyg Barstool 75 cm Front Upholstery Sand & Black Oak**

Colli: 1  
Size & Weight: H: 94 x W: 46,5 x D: 46,5 x SH: 75 cm - 5,9 kg  
Packing: Brown Box - H: 96 x L: 49,5 x D: 48,5 cm - 7,9 kg  
M3: 0,2305  
Material: Shell: Polypropylene with PU foam and front upholstery. Legs: Painted and lacquered oak, Upholstery: See price groups.  
Production time: 5 weeks

709571  
Group 1

709572  
Group 2

709573  
Group 3

709574  
Group 4

709575  
Group 5

709576  
Group 6

709577  
Group 7

# HYG BARSTOOL 75 CM FULL UPHOLSTERY WOOD

Design: Simon Legald, 2019  
Duty Code: 9401610000  
Made in: Denmark  
Price Groups: 1) Oceanic, Aquarius  
2) Remix, Main Line Flax, Synergy  
3) Canvas, Yoredale  
4) Steelcut Trio, City Velvet  
5) Divina, Divina MD, Divina Melange, Hallingdal, Fiord  
6) Zero, Vidar  
7) Elle, Ultra Læder

## Hyg Barstool 75 cm Full Upholstery Oak

Colli: 1  
Size & Weight: H: 94 x W: 46,5 x D: 46,5 x SH: 75 cm - 6 kg  
Packing: Brown Box - H: 96 x L: 49,5 x D: 48,5 cm - 8 kg  
M3: 0,2305  
Material: Shell: Polypropylene with PU foam and full upholstery. Legs:  
Lacquered oak, Upholstery: See price groups.  
Production time: 5 weeks

709521  
Group 1

709522  
Group 2

709523  
Group 3

709524  
Group 4

709525  
Group 5

709526  
Group 6

709527  
Group 7

## Hyg Barstool 75 cm Full Upholstery Black Oak

Colli: 1  
Size & Weight: H: 94 x W: 46,5 x D: 46,5 x SH: 75 cm - 6 kg  
Packing: Brown Box - H: 96 x L: 49,5 x D: 48,5 cm - 8 kg  
M3: 0,2305  
Material: Shell: Polypropylene with PU foam and full upholstery. Legs:  
Painted and lacquered oak, Upholstery: See price groups.  
Production time: 5 weeks

709581  
Group 1

709582  
Group 2

709583  
Group 3

709584  
Group 4

709585  
Group 5

709586  
Group 6

709587  
Group 7

## HYG BARSTOOL 75 CM STEEL

Design: Simon Legald, 2019  
 Duty Code: 9401790000  
 Made in: Denmark  
 Construction: Pressed Polypropylen shell attached with 4 screws and cups to steel frame. Hyg is delivered fully assembled.  
 Maintenance: Clean with damp cloth.

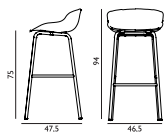

### Hyg Barstool 75 cm Steel

Colli: 1  
 Size & Weight: H: 94 x W: 46,5 x D: 47,5 x SH: 75 cm - 5,8 kg  
 Packing: Brown Box - H: 96 x L: 49,5 x D: 48,5 cm - 7,8 kg  
 M3: 0,2305  
 Material: Shell: Polypropylene, Legs: Powder Coated Steel  
 Production time: 2 weeks

 604064 White	 604065 Grey	 604066 Black	 604067 Olive
			 604068 Sand

## HYG BARSTOOL 75 CM FRONT UPHOLSTERY STEEL

Design: Simon Legald, 2019  
 Duty Code: 9401710000  
 Made in: Denmark  
 Price Groups: 1) Oceanic, Aquarius  
 2) Remix, Main Line Flax, Synergy  
 3) Canvas, Yoredale  
 4) Steelcut Trio, City Velvet  
 5) Divina, Divina MD, Divina Melange, Hallingdal, Fiord  
 6) Zero, Vidar  
 7) Elle, Ultra Læder

### Hyg Barstool 75 cm Front Upholstery White & White Steel

Colli: 1  
 Size & Weight: H: 94 x W: 46,5 x D: 47,5 x SH: 75 cm - 6,2 kg  
 Packing: Brown Box - H: 96 x L: 49,5 x D: 48,5 cm - 8,2 kg  
 M3: 0,2305  
 Material: Shell: Polypropylene with PU foam and front upholstery. Legs: Powder coated steel, Upholstery: See price groups.  
 Production time: 5 weeks

709591 Group 1
709592 Group 2
709593 Group 3
709594 Group 4
709595 Group 5
709596 Group 6
709597 Group 7



**Hyg Barstool 75 cm Front Upholstery Grey & Grey Steel**

Colli: 1  
Size & Weight: H: 94 x W: 46,5 x D: 47,5 x SH: 75 cm - 6,2 kg  
Packing: Brown Box - H: 96 x L: 49,5 x D: 48,5 cm - 8,2 kg  
M3: 0,2305  
Material: Shell: Polypropylene with PU foam and front upholstery. Legs: Powder coated steel, Upholstery: See price groups.  
Production time: 5 weeks

709601  
Group 1

709602  
Group 2

709603  
Group 3

709604  
Group 4

709605  
Group 5

709606  
Group 6

709607  
Group 7

**Hyg Barstool 75 cm Front Upholstery Black & Black Steel**

Colli: 1  
Size & Weight: H: 94 x W: 46,5 x D: 47,5 x SH: 75 cm - 6,2 kg  
Packing: Brown Box - H: 96 x L: 49,5 x D: 48,5 cm - 8,2 kg  
M3: 0,2305  
Material: Shell: Polypropylene with PU foam and front upholstery. Legs: Powder coated steel, Upholstery: See price groups.  
Production time: 5 weeks

709611  
Group 1

709612  
Group 2

709613  
Group 3

709614  
Group 4

709615  
Group 5

709616  
Group 6

709617  
Group 7

**Hyg Barstool 75 cm Front Upholstery Olive & Olive Steel**

Colli: 1  
Size & Weight: H: 94 x W: 46,5 x D: 47,5 x SH: 75 cm - 6,2 kg  
Packing: Brown Box - H: 96 x L: 49,5 x D: 48,5 cm - 8,2 kg  
M3: 0,2305  
Material: Shell: Polypropylene with PU foam and front upholstery. Legs: Powder coated steel, Upholstery: See price groups.  
Production time: 5 weeks

709621  
Group 1

709622  
Group 2

709623  
Group 3

709624  
Group 4

709625  
Group 5

709626  
Group 6

709627  
Group 7

**Hyg Barstool 75 cm Front Upholstery Sand & Sand Steel**

Colli: 1  
Size & Weight: H: 94 x W: 46,5 x D: 47,5 x SH: 75 cm - 6,2 kg  
Packing: Brown Box - H: 96 x L: 49,5 x D: 48,5 cm - 8,2 kg  
M3: 0,2305  
Material: Shell: Polypropylene with PU foam and front upholstery. Legs: Powder coated steel, Upholstery: See price groups.  
Production time: 5 weeks

709631  
Group 1

709632  
Group 2

709633  
Group 3

709634  
Group 4

709635  
Group 5

709636  
Group 6

709637  
Group 7

# HYG BARSTOOL 75 CM FULL UPHOLSTERY STEEL

Design: Simon Legald, 2019  
Duty Code: 9401710000  
Made in: Denmark  
Price Groups: 1) Oceanic, Aquarius  
2) Remix, Main Line Flax, Synergy  
3) Canvas, Yoredale  
4) Steelcut Trio, City Velvet  
5) Divina, Divina MD, Divina Melange, Hallingdal, Fiord  
6) Zero, Vidar  
7) Elle, Ultra Læder

## Hyg Barstool 75 cm Full Upholstery White Steel

Colli: 1  
Size & Weight: H: 94 x W: 46,5 x D: 47,5 x SH: 75 cm - 6,6 kg  
Packing: Brown Box - H: 96 x L: 49,5 x D: 48,5 cm - 8,6 kg  
M3: 0,2305  
Material: Shell: Polypropylene with PU foam and full upholstery. Legs: Powder coated steel, Upholstery: See price groups.  
Production time: 5 weeks

709641  
Group 1

709642  
Group 2

709643  
Group 3

709644  
Group 4

709645  
Group 5

709646  
Group 6

709647  
Group 7

## Hyg Barstool 75 cm Full Upholstery Grey Steel

Colli: 1  
Size & Weight: H: 94 x W: 46,5 x D: 47,5 x SH: 75 cm - 6,6 kg  
Packing: Brown Box - H: 96 x L: 49,5 x D: 48,5 cm - 8,6 kg  
M3: 0,2305  
Material: Shell: Polypropylene with PU foam and full upholstery. Legs: Powder coated steel, Upholstery: See price groups.  
Production time: 5 weeks

709651  
Group 1

709652  
Group 2

709653  
Group 3

709654  
Group 4

709655  
Group 5

709656  
Group 6

709657  
Group 7

**Hyg Barstool 75 cm Full Upholstery Black Steel**

Colli: 1  
Size & Weight: H: 94 x W: 46,5 x D: 47,5 x SH: 75 cm - 6,6 kg  
Packing: Brown Box - H: 96 x L: 49,5 x D: 48,5 cm - 8,6 kg  
M3: 0,2305  
Material: Shell: Polypropylene with PU foam and full upholstery. Legs:  
Powder coated steel, Upholstery: See price groups.  
Production time: 5 weeks

709661  
Group 1

709662  
Group 2

709663  
Group 3

709664  
Group 4

709665  
Group 5

709666  
Group 6

709667  
Group 7

**Hyg Barstool 75 cm Full Upholstery Olive Steel**

Colli: 1  
Size & Weight: H: 94 x W: 46,5 x D: 47,5 x SH: 75 cm - 6,6 kg  
Packing: Brown Box - H: 96 x L: 49,5 x D: 48,5 cm - 8,6 kg  
M3: 0,2305  
Material: Shell: Polypropylene with PU foam and full upholstery. Legs:  
Powder coated steel, Upholstery: See price groups.  
Production time: 5 weeks

709671  
Group 1

709672  
Group 2

709673  
Group 3

709674  
Group 4

709675  
Group 5

709676  
Group 6

709677  
Group 7

<b>Hyg Barstool 75 cm Full Upholstery Sand Steel</b>
Colli: 1 Size & Weight: H: 94 x W: 46,5 x D: 47,5 x SH: 75 cm - 6,6 kg Packing: Brown Box - H: 96 x L: 49,5 x D: 48,5 cm - 8,6 kg M3: 0,2305 Material: Shell: Polypropylene with PU foam and full upholstery. Legs: Powder coated steel, Upholstery: See price groups. Production time: 5 weeks
709681 Group 1
709682 Group 2
709683 Group 3
709684 Group 4
709685 Group 5
709686 Group 6

## HYG SOFA

Design: Simon Legald, 2018  
 Duty Code: 9401610000  
 Made in: Lithuania  
 Price Groups: 1) Oceanic, Aquarius  
 2) Remix, Main Line Flax, Synergy  
 3) Canvas, Yoredale  
 4) Steelcut Trio, City Velvet  
 5) Divina, Divina MD, Divina Melange, Hallingdal, Fiord  
 6) Zero, Vidar  
 7) Elle, Ultra Læder



<b>Hyg Sofa Oak</b>
Colli: 1 Size & Weight: H: 107,5 x W: 168 x D: 86 x SH: 40 cm - 36 kg Packing: Brown Box - H: 110 x L: 172 x D: 93 cm - 42,2 kg Material: Shell: Hard Molded PU Foam w. Steel Reinforcement, Cushion: Soft Molded PU Foam, Legs: Oak, Upholstery: See price groups Production time: 6 weeks
709691 Group 1
709692 Group 2
709693 Group 3
709694 Group 4
709695 Group 5
709696 Group 6
709697 Group 7

<p><b>Hyg Sofa Black Oak</b></p> <p>Size &amp; Weight: H: 107,5 x W: 168 x D: 86 x SH: 40 cm - 36 kg  Packing: Brown Box - H: 110 x L: 172 x D: 93 cm - 42,2 kg  Material: Shell: Hard Molded PU Foam w. Steel Reinforcement, Cushion: Soft Molded PU Foam, Legs: Painted and lacquered oak, Upholstery: See price groups  Production time: 6 weeks</p>
709701 Group 1
709702 Group 2
709703 Group 3
709704 Group 4
709705 Group 5
709706 Group 6
709707 Group 7

## HYG FOOTSTOOL

Design: Simon Legald, 2018  
Duty Code: 9401610000  
Made in: Lithuania  
Price Groups: 1) Oceanic, Aquarius  
2) Remix, Main Line Flax, Synergy  
3) Canvas, Yoredale  
4) Steelcut Trio, City Velvet  
5) Divina, Divina MD, Divina Melange, Hallingdal, Fiord  
6) Zero, Vidar  
7) Elle, Ultra Læder



<p><b>Hyg Footstool Oak</b></p> <p>Coll: 1  Size &amp; Weight: H: 39 x W: 62,5 x D: 48,5 x SH: 39 cm - 6 kg  Packing: Brown Box - H: 42,5 x L: 64,5 x D: 51,5 cm - 8,7 kg  Material: Cushion: Soft Molded PU Foam w. Steel Reinforcement, Legs: Oak, Upholstery: See price groups  Production time: 6 weeks</p>
709711 Group 1
709712 Group 2
709713 Group 3
709714 Group 4
709715 Group 5
709716 Group 6
709717 Group 7

<b>Hyg Footstool Black Oak</b>	
Size & Weight:	H: 39 x W: 62,5 x D: 48,5 x SH: 39 cm - 6 kg
Packing:	Brown Box - H: 42,5 x L: 64,5 x D: 51,5 cm - 8,7 kg
Material:	Cushion: Soft Molded PU Foam w. Steel Reinforcement, Legs: Painted and lacquered oak, Upholstery: See price groups
Production time: 6 weeks	
709721	Group 1
709722	Group 2
709723	Group 3
709724	Group 4
709725	Group 5
709726	Group 6
709727	Group 7

## HYG FOOTSTOOL SWIVEL

Design: Simon Legald, 2018

Duty Code: 9401710000

Made in: Lithuania

Price Groups: 1) Oceanic, Aquarius

2) Remix, Main Line Flax, Synergy

3) Canvas, Yoredale

4) Steelcut Trio, City Velvet

5) Divina, Divina MD, Divina Melange, Hallingdal, Fiord

6) Zero, Vidar

7) Elle, Ultra Læder

<b>Hyg Footstool Swivel Alu</b>	
Coll:	1
Size & Weight:	H: 39 x W: 62,5 x D: 48,5 x SH: 39 cm - 7,5 kg
Packing:	Brown Box - H: 42,5 x L: 64,5 x D: 51,5 cm - 10,2 kg
Material:	Cushion: Soft Molded PU Foam w. Steel Reinforcement, Legs: Aluminum, Upholstery: See price groups
Production time: 6 weeks	
709731	Group 1
709732	Group 2
709733	Group 3
709734	Group 4
709735	Group 5
709736	Group 6
709737	Group 7







<p><b>Hyg Footstool Swivel Black Alu</b></p> <p>Size &amp; Weight: H: 39 x W: 62,5 x D: 48,5 x SH: 39 cm - 7,5 kg  Packing: Brown Box - H: 42,5 x L: 64,5 x D: 51,5 cm - 10,2 kg  Material: Cushion: Soft Molded PU Foam w. Steel Reinforcement, Legs: Powder coated aluminum, Upholstery: See price groups  Production time: 6 weeks</p>
709741 Group 1
709742 Group 2
709743 Group 3
709744 Group 4
709745 Group 5
709746 Group 6
709747 Group 7

## HYG GLIDES

Duty Code: 9401999090

Construction: Different types of flooring require different types of glides.

Maintenance: We recommend to check the glides every 3-6 months. If worn down, please replace.

<b>Hyg Lounge Chair, Sofa &amp; Footstool Glides</b>	
	900122 PE for wood / Black / 4pcs
<b>Hyg Chair Swivel Glides</b>	
	900239 PE swivel / Black / 4pcs
<b>Hyg Chair &amp; Barstool Glides</b>	
	900273 PS for wood w. felt / Black / 4pcs
	900274 NIPH for wood Black / 4pcs
	900275 PA for steel w. felt / Black / 4pcs
	900276 PA for steel / Black / 4pcs



# JALOUSI

Design: Simon Legald, 2016  
 Duty Code: 9403208000  
 Made in: Latvia  
 Construction: Jalousi is constructed of MDF and veneered with lacquered oak. The front doors are made of ABS.  
 Maintenance: Clean with damp cloth.

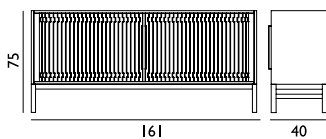

## Jalousi Sideboard

Colli: 1  
 Size & Weight: H: 75 x W: 40 x L: 161 cm - 63 kg  
 Packing: Brown Box - H: 83 x L: 167 x D: 43 cm - 67 kg  
 M3: 0,596  
 Material: MDF, Oak veneer, ABS

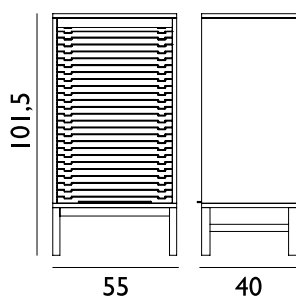
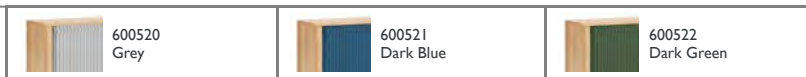

## Jalousi Cabinet Low

Colli: 1  
 Size & Weight: H: 101,5 x W: 40 x L: 55 cm - 32,5 kg  
 Material: MDF, Oak veneer, ABS

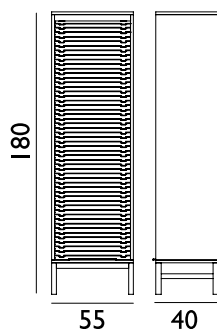
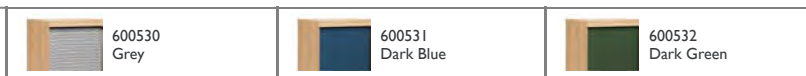

## Jalousi Cabinet High

Colli: 1  
 Size & Weight: H: 180 x W: 40 x L: 55 cm - 57 kg  
 Material: MDF, Oak veneer, ABS

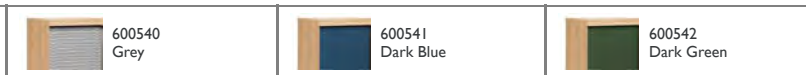

# JAM

Design: Rudolph Schelling Webermann, 2018  
 Duty Code: 9403208000  
 Made in: China

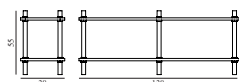

## Jam Bookcase 6 poles

Colli: 1  
 Size & Weight: H: 55 x W: 38 x L: 138 cm - 19 kg  
 Packing: Brown Box - H: 19 x L: 145,5 x D: 44 cm - 21 kg  
 Material: Shelves: Chipboard with Oak Veneer; Poles: Solid Oak, Polypropylene



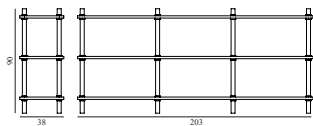

### Jam Bookcase 8 poles

Colli: 1  
 Size & Weight: H: 90 x W: 38 x L: 203 cm - 39 kg  
 Packing: Brown Box - H: 19 x L: 210 x D: 44 cm - 42,5 kg  
 M3: 0,1756  
 Material: Shelves: Chipboard with Oak Veneer, Poles: Solid Oak, Polypropylene



## JET

Design: Simon Legald, 2016  
 Duty Code: 8302500000  
 Made in: China  
 Construction: Extruded aluminum, CNC cut after extrusion. Delivered with plugs and screws + mounting bracket. Max load on the shelf is estimated to 5 kg on 80 cm and 10 kg on 160 cm.  
 Maintenance: Clean with damp cloth.



### Jet Shelf 80 cm

Colli: 1  
 Size & Weight: H: 11 x L: 80 x D: 21 cm - 2,1 kg  
 Packing: Brown Box - H: 29,5 x L: 84 x D: 18 cm - 3 kg  
 Material: Jet in White and Black: Powder Coated Aluminum.

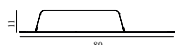

600992  
White

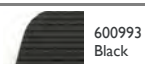

600993  
Black

### Jet Shelf 160 cm

Colli: 1  
 Size & Weight: H: 11 x L: 160 x D: 21 cm - 4,5 kg  
 Packing: Brown Box - H: 30,5 x L: 167 x D: 18 cm - 6,4 kg  
 Material: Jet in White and Black: Powder Coated Aluminum. Jet in Silver & Champagne: Aluminum with anodized surface.



600996  
White

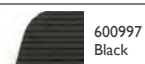

600997  
Black

## JOURNAL

Design: Simon Legald, 2016  
 Duty Code: 9403601000  
 Made in: Denmark  
 Construction: Laminated tabletop with oak edge, powder coated steel legs, steel drawer; painted in same color as tabletop and legs. Silicone rosette at hole for power-cords.  
 Maintenance: Clean with damp cloth.

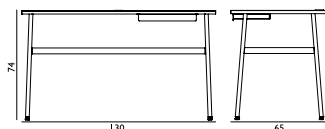

### Journal Desk

Colli: 1  
 Size & Weight: H: 74 x W: 65 x L: 130 cm - 20,5 kg  
 Packing: Brown Box - H: 20 x L: 151 x D: 90 cm - 22 kg  
 M3: 0,2718  
 Material: Laminated table-top, legs in powder coated steel, drawer in steel  
 Production time: 5 weeks

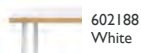

602188  
White

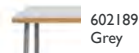

602189  
Grey



602190  
Black

# JUST CHAIR WOOD

Design: Iskos-Berlin, 2016  
 Duty Code: 9401690000  
 Made in: Latvia  
 Construction: Just consists of a shell and legs made of oak veneer. Just chair is delivered assembled.  
 Maintenance: Clean with damp cloth.

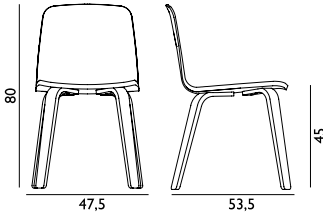

## Just Chair Oak

Colli: 2  
 Size & Weight: H: 80 x W: 47,5 x D: 53,5 x SH: 45 cm - 5,5 kg  
 Packing: Brown Box - H: 95,5 x L: 68 x D: 56 cm - 14 kg  
 Material: Lacquered Oak Veneer or Painted and Lacquered Ash Veneer.  
 Production time: 2 weeks



602071  
 Oak /  
 Oak



602072  
 Black /  
 Black

# JUST CHAIR STEEL

Design: Iskos-Berlin, 2014  
 Awards: Interior Innovation Award – Selection 2014, Germany  
 Duty Code: 9403601000  
 Made in: Latvia  
 Construction: Just consists of a shell made of molded ash or oak veneer and a steel or chrome frame. The frame is mounted to the seat by slotting seamlessly into the millings underneath the seat. The chairs are stackable, up to 6 pcs. The chair is delivered assembled.  
 Maintenance: Clean with damp cloth.

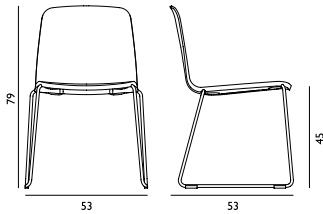

## Just Chair Steel

Colli: 1  
 Size & Weight: H: 79 x W: 53 x D: 53 x SH: 45 cm - 6,3 kg  
 Packing: Brown Box - H: 93 x L: 70,5 x D: 60 cm (4 pcs) - 30 kg  
 Material: Lacquered Ash Veneer, Lacquered Oak Veneer or Painted and Lacquered Ash Veneer, Legs: Powder Coated Steel / Chrome  
 Production time: 2 weeks



602065  
 Black /  
 Black /  
 Black



602066  
 Black /  
 Black /  
 Ash



602069  
 Chrome /  
 Ash



602070  
 Chrome /  
 Oak



602559  
 Black /  
 Oak



602560  
 Chrome /  
 Black

# JUST CHAIR FULL UPHOLSTERY STEEL

Design: Iskos-Berlin, 2014  
Awards: Interior Innovation Award – Selection 2014, Germany  
Duty Code: 9401710000  
Made in: Latvia  
Price Groups: 1) Oceanic, Aquarius  
2) Remix, Main Line Flax, Synergy  
3) Canvas, Yoredale  
4) Steelcut Trio, City Velvet  
5) Divina, Divina MD, Divina Melange, Hallingdal, Fiord  
6) Zero, Vidar  
7) Elle, Ultra Læder

<b>Just Chair Full Upholstery Black Steel</b>
Colli: 1 Size & Weight: H: 79 x W: 53 x D: 53 x SH: 45 cm - 7,2 kg Packing: Brown Box - H: 104,5 x L: 67,5 x D: 57 cm - 18 kg Material: Shell: Ash Veneer, PU Foam, Legs: Powder Coated Steel, Upholstery: See price groups. Production time: 6 weeks
709751 Group 1
709752 Group 2
709753 Group 3
709754 Group 4
709755 Group 5
709756 Group 6
709757 Group 7

<b>Just Chair Full Upholstery Chrome</b>
Colli: 1 Size & Weight: H: 79 x W: 53 x D: 53 x SH: 45 cm - 7,2 kg Packing: Brown Box - H: 104,5 x L: 67,5 x D: 57 cm - 18 kg Material: Shell: Ash Veneer, PU Foam, Legs: Chrome, Upholstery: See price groups. Production time: 6 weeks
709761 Group 1
709762 Group 2
709763 Group 3
709764 Group 4
709765 Group 5
709766 Group 6
709767 Group 7

# JUST BARSTOOL

Design: Iskos-Berlin, 2016  
 Duty Code: 9401790000  
 Made in: Latvia  
 Construction: Just is delivered assembled.  
 Maintenance: Clean with damp cloth.

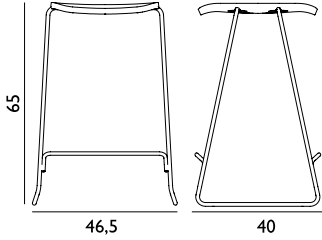

## Just Barstool 65 cm

Colli: 1  
 Size & Weight: H: 65 x W: 46,5 x D: 40 x SH: 65 cm - 6,3 kg  
 Packing: Brown Box - H: 102,5 x L: 51 x D: 51 cm (4 pcs) - 27,8 kg  
 Material: Lacquered Oak Veneer or Painted and Lacquered Ash Veneer,  
 Legs: Powder Coated Steel / Chrome.  
 Production time: 2 weeks

 602555 Black / Oak	 602556 Chrome / Black	 602670 Chrome / Oak	 602671 Black / Black
------------------------------------------------------------------------------------------------------------	---------------------------------------------------------------------------------------------------------------	---------------------------------------------------------------------------------------------------------------	----------------------------------------------------------------------------------------------------------------

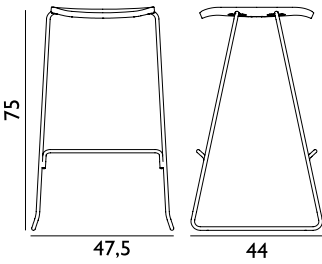

## Just Barstool 75 cm

Colli: 1  
 Size & Weight: H: 75 x W: 47,5 x D: 44 x SH: 75 cm - 6,6 kg  
 Packing: Brown Box - H: 102,5 x L: 51 x D: 51 cm (4 pcs) - 29,2 kg  
 Material: Lacquered Oak Veneer or Painted and Lacquered Ash Veneer,  
 Legs: Powder Coated Steel / Chrome.  
 Production time: 2 weeks

 602551 Black / Oak	 602552 Chrome / Black	 602680 Chrome / Oak	 602681 Black / Black
------------------------------------------------------------------------------------------------------------	---------------------------------------------------------------------------------------------------------------	---------------------------------------------------------------------------------------------------------------	----------------------------------------------------------------------------------------------------------------

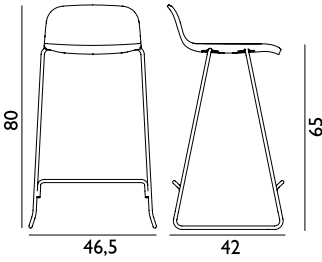

## Just Barstool 65 cm w. back

Colli: 1  
 Size & Weight: H: 80 x W: 46,5 x D: 42 x SH: 65 cm - 6,8 kg  
 Packing: Brown Box - H: 106 x L: 54 x D: 52 cm (4 pcs) - 29,8 kg  
 Material: Lacquered Oak Veneer or Painted and Lacquered Ash Veneer,  
 Legs: Powder Coated Steel / Chrome.  
 Production time: 2 weeks

 602557 Black / Oak	 602558 Chrome / Black	 602690 Chrome / Oak	 602691 Black / Black
--------------------------------------------------------------------------------------------------------------	-----------------------------------------------------------------------------------------------------------------	-----------------------------------------------------------------------------------------------------------------	------------------------------------------------------------------------------------------------------------------

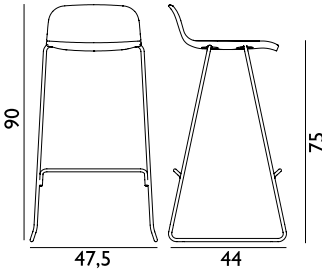

## Just Barstool 75 cm w. back

Colli: 1  
 Size & Weight: H: 90 x W: 47,5 x D: 44 x SH: 75 cm - 7 kg  
 Packing: Brown Box - H: 108 x L: 53,5 x D: 51 cm (3 pcs) - 24 kg  
 Material: Lacquered Oak Veneer or Painted and Lacquered Ash Veneer,  
 Legs: Powder Coated Steel / Chrome.  
 Production time: 2 weeks

 602553 Black / Oak	 602554 Chrome / Black	 602700 Chrome / Oak	 602701 Black / Black
--------------------------------------------------------------------------------------------------------------	-----------------------------------------------------------------------------------------------------------------	-----------------------------------------------------------------------------------------------------------------	------------------------------------------------------------------------------------------------------------------

# JUST BARSTOOL 65 CM FULL UPHOLSTERY STEEL

Design: Iskos-Berlin, 2014  
Awards: Interior Innovation Award – Selection 2014, Germany  
Duty Code: 9401710000  
Made in: Latvia  
Price Groups: 1) Oceanic, Aquarius  
2) Remix, Main Line Flax, Synergy  
3) Canvas, Yoredale  
4) Steelcut Trio, City Velvet  
5) Divina, Divina MD, Divina Melange, Hallingdal, Fiord  
6) Zero, Vidar  
7) Elle, Ultra Læder

<b>Just Barstool 65 cm Full Upholstery Black Steel</b> Colli: 1 Size & Weight: H: 65 x W: 46,5 x D: 40 x SH: 65 cm - 6,3 kg Packing: Brown Box - H: 1000 x L: 500 x D: 500 cm Material: Shell: Lacquered Oak Veneer; Legs: Powder Coated Steel, Upholstery: See price groups. Production time: 6 weeks
709771 Group 1
709772 Group 2
709773 Group 3
709774 Group 4
709775 Group 5
709776 Group 6
709777 Group 7

<b>Just Barstool 65 cm w. back Full Upholstery Black Steel</b> Colli: 1 Size & Weight: H: 80 x W: 46,5 x D: 42 x SH: 65 cm - 6,4 kg Packing: Brown Box - H: 1150 x L: 520 x D: 500 cm Material: Shell: Lacquered Oak Veneer; Legs: Powder Coated Steel, Upholstery: See price groups. Production time: 6 weeks
709781 Group 1
709782 Group 2
709783 Group 3
709784 Group 4
709785 Group 5
709786 Group 6
709787 Group 7

**Just Barstool 65 cm Full Upholstery Chrome**

Colli: 1  
Size & Weight: H: 65 x W: 46,5 x D: 40 x SH: 65 cm - 6,3 kg  
Packing: Brown Box - H: 1000 x L: 500 x D: 500 cm  
Material: Shell: Lacquered Oak Veneer, Legs: Chrome, Upholstery: See price groups.  
Production time: 6 weeks

709791  
Group 1

709792  
Group 2

709793  
Group 3

709794  
Group 4

709795  
Group 5

709796  
Group 6

709797  
Group 7

**Just Barstool 65 cm w. back Full Upholstery Chrome**

Colli: 1  
Size & Weight: H: 80 x W: 46,5 x D: 42 x SH: 65 cm - 6,4 kg  
Packing: Brown Box - H: 1150 x L: 520 x D: 500 cm  
Material: Shell: Lacquered Oak Veneer, Legs: Chrome, Upholstery: See price groups.  
Production time: 6 weeks

709801  
Group 1

709802  
Group 2

709803  
Group 3

709804  
Group 4

709805  
Group 5

709806  
Group 6

709807  
Group 7

# JUST BARSTOOL 75 CM FULL UPHOLSTERY STEEL

Design: Iskos-Berlin, 2014  
Duty Code: 9401710000  
Made in: Latvia  
Price Groups: 1) Oceanic, Aquarius  
2) Remix, Main Line Flax, Synergy  
3) Canvas, Yoredale  
4) Steelcut Trio, City Velvet  
5) Divina, Divina MD, Divina Melange, Hallingdal, Fiord  
6) Zero, Vidar  
7) Elle, Ultra Læder

## Just Barstool 75 cm Full Upholstery Black Steel

Colli: 1  
Size & Weight: H: 75 x W: 47,5 x D: 44 x SH: 75 cm - 6,9 kg  
Packing: Brown Box - H: 1000 x L: 500 x D: 500 cm  
Material: Shell: Lacquered Oak Veneer, Legs: Powder Coated Steel,  
Upholstery: See price groups.  
Production time: 6 weeks

709811  
Group 1

709812  
Group 2

709813  
Group 3

709814  
Group 4

709815  
Group 5

709816  
Group 6

709817  
Group 7

## Just Barstool 75 cm w. back Full Upholstery Black Steel

Colli: 1  
Size & Weight: H: 90 x W: 47,5 x D: 44 x SH: 75 cm - 7 kg  
Packing: Brown Box - H: 1150 x L: 520 x D: 500 cm  
Material: Shell: Lacquered Oak Veneer, Legs: Powder Coated Steel,  
Upholstery: See price groups.  
Production time: 6 weeks

709821  
Group 1

709822  
Group 2

709823  
Group 3

709824  
Group 4

709825  
Group 5

709826  
Group 6

709827  
Group 7



**Just Barstool 75 cm Full Upholstery Chrome**

Colli: 1  
Size & Weight: H: 75 x W: 47,5 x D: 44 x SH: 75 cm - 6,9 kg  
Packing: Brown Box - H: 1000 x L: 500 x D: 500 cm  
Material: Shell: Lacquered Oak Veneer, Legs: Chrome, Upholstery: See price groups.  
Production time: 6 weeks

709831  
Group 1

709832  
Group 2

709833  
Group 3

709834  
Group 4

709835  
Group 5

709836  
Group 6

709837  
Group 7

**Just Barstool 75 cm w. back Full Upholstery Chrome**

Colli: 1  
Size & Weight: H: 90 x W: 47,5 x D: 44 x SH: 75 cm - 7 kg  
Packing: Brown Box - H: 1150 x L: 520 x D: 500 cm  
Material: Shell: Lacquered Oak Veneer, Legs: Chrome, Upholstery: See price groups.  
Production time: 6 weeks

709841  
Group 1

709842  
Group 2

709843  
Group 3

709844  
Group 4

709845  
Group 5

709846  
Group 6





709847  
Group 7

# JUST GLIDES

Duty Code: 9401999090

Construction: Different types of flooring require different types of glides.

Maintenance: We recommend to check the glides every 3-6 months. If worn down, please replace.

Just Chair & Barstool Glides	
	900112 PA for steel / Black / 4pcs
	900113 PA for steel w. felt / Black / 4pcs
	900114 PC for chrome w. felt / White / 4pcs
	900115 PE for wood / Black / 4pcs
	900116 PE for wood w. felt / Black / 4pcs
	900238 PC for chrome / White / 4 pcs

# KABINO

Design: Simon Legald, 2013

Duty Code: 9403208000

Made in: Latvia

Construction: Kabino comes flat packed and is assembled using the included manual and tools. Kabino is made of painted MDF with an ash frame mounted to its front. Fronts are made of matt lacquered aluminum. 2 Kabinos can be stacked on top of each other if the legs are removed. Size of Kabino Sideboard without legs is H: 51 x L: 114 x D: 42 cm. Load capacity of each drawer: ca. 6-8 kg.

Maintenance: Clean with damp cloth.

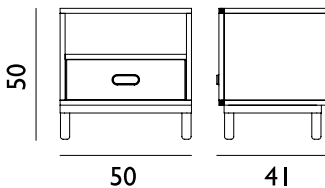

## Kabino Bedside Table

Colli: 1  
Size & Weight: H: 50 x W: 41 x L: 50 cm - 20,8 kg  
Packing: Brown Box - H: 30 x L: 84 x D: 49 cm - 26,4 kg  
M3: 0,1235  
Material: Ash, MDF, Aluminum



601053  
White



601054  
Grey

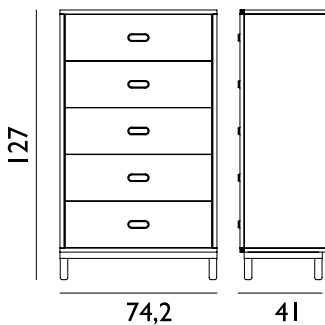

## Kabino Dresser w. 5 Drawers

Colli: 1  
Size & Weight: H: 127 x W: 41 x L: 74,2 cm - 66,4 kg  
Packing: Brown Box - H: 21 x L: 152 x D: 84 cm - 74,2 kg  
M3: 0,2681  
Material: Ash, MDF, Aluminum



601051  
White



601052  
Grey

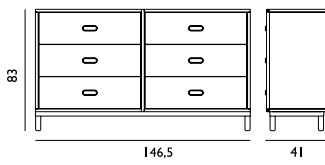

### Kabino Dresser w. 6 Drawers

Colli: 1  
 Size & Weight: H: 83 x W: 41 x L: 146,5 cm - 86 kg  
 Packing: Brown Box - H: 23 x L: 183 x D: 88 cm - 94 kg  
 M3: 0,3704  
 Material: Ash, MDF, Aluminum

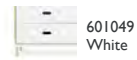

601049  
White



601050  
Grey

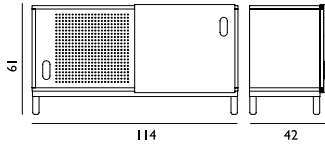

### Kabino Sideboard

Colli: 1  
 Size & Weight: H: 61 x W: 42 x L: 114 cm - 34 kg  
 Packing: Brown Box - H: 60 x L: 132 x D: 21 cm - 42 kg  
 M3: 0,1663  
 Material: Ash, MDF, Aluminum

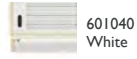

601040  
White

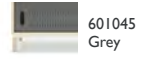

601045  
Grey

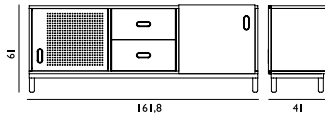

### Kabino Sideboard w. Drawers

Colli: 1  
 Size & Weight: H: 61 x W: 41 x L: 161,8 cm - 54 kg  
 Packing: Brown Box - H: 24 x L: 194 x D: 59 cm - 66,7 kg  
 M3: 0,2747  
 Material: Ash, MDF, Aluminum



601047  
White

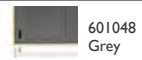

601048  
Grey

## KNOT

Design: Tatsuo Kuroda, 2012  
 Duty Code: 9403601000  
 Made in: China  
 Construction: Knot chair is made of stained ash and the back is assembled with paper cord joints. Knot chair is delivered assembled.  
 Maintenance: Clean with damp cloth. Avoid getting the chairs wet, as the color can rub off.

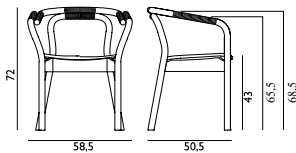

### Knot Chair

Colli: 1  
 Size & Weight: H: 72 x W: 58,5 x D: 50,5 x SH: 43 cm - 5 kg  
 Packing: Brown Box - H: 78 x L: 56 x D: 63 cm - 11,2 kg  
 M3: 0,2752  
 Material: Stained Ash, Paper Cord



602011  
Black /  
Nature



602012  
Black /  
Black

## KNOT GLIDES

Duty Code: 9401999090  
 Construction: Different types of flooring require different types of glides.  
 Maintenance: We recommend to check the glides every 3-6 months. If worn down, please replace.

### Knot Chair Glides



900240  
PP /  
Black /  
4 pcs

# LUNAR TABLE H40 CM ALU

Design: Simon Legald, 2021

Duty Code: 9403890090

Made in: Denmark

Construction: Lunar table consist of a casted aluminum center-base with four legs available in polished aluminum or powder coated black aluminum. The tabletop comes in black marble, white marble, oak veneer or black painted oak veneer. Lunar table is available in two heights. The marble tabletops are treated with a surface treatment that penetrates into the material and thereby provides a long-term protection. The surface should not be exposed to acidic foods or beverages, which can leave stains on the surface.

Maintenance: Clean with a damp cloth.

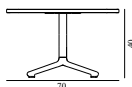

## Lunar Coffee Table H40 Ø70 cm Alu/ Oak

Colli: 1  
Size & Weight: H: 40 x Ø: 70 cm - 11,85 kg  
Packing: Tabletop: Brown Box - L: 73 x B: 73 x D: 4,5 cm - 8,9 kg - 0,024 m<sup>3</sup> - Base: Brown Box - L: 52 x W: 52 x H: 16,5 cm - 6,35 kg - 0,045 m<sup>3</sup>  
Material: Base in casted aluminum center in polished aluminum. Tabletop in oak veneer or black painted oak veneer.  
Color: Oak, Black oak  
Production time: 2 weeks

604166  
Oak

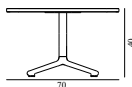

## Lunar Coffee Table H40 Ø70 cm Alu/ Marble

Colli: 1  
Size & Weight: H: 40 x Ø: 70 cm - 22,05 kg  
Packing: Tabletop: Brown Box - L: 73 x B: 73 x D: 4,5 cm - 8,9 kg - 0,024 m<sup>3</sup> - Base: Brown Box - L: 52 x W: 52 x H: 16,5 cm - 6,35 kg - 0,045 m<sup>3</sup>  
Material: Base in casted aluminum center in polished aluminum. Tabletop in polished marble.  
Color: Black, White, Sand, Coffee  
Production time: 2 weeks

604167  
Marble

# LUNAR TABLE H40 CM BLACK ALU

Design: Simon Legald, 2021

Duty Code: 9403890090

Made in: Denmark

Construction: Lunar table consist of a casted aluminum center-base with four legs available in polished aluminum or powder coated black aluminum. The tabletop comes in black marble, white marble, oak veneer or black painted oak veneer. Lunar table is available in two heights. The marble tabletops are treated with a surface treatment that penetrates into the material and thereby provides a long-term protection. The surface should not be exposed to acidic foods or beverages, which can leave stains on the surface.

Maintenance: Clean with a damp cloth.

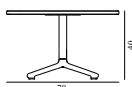

## Lunar Coffee Table H40 Ø70 cm Black Alu/ Oak

Colli: 1  
Size & Weight: H: 40 x Ø: 70 cm - 11,85 kg  
Packing: Tabletop: Brown Box - L: 73 x B: 73 x D: 4,5 cm - 8,9 kg - 0,024 m<sup>3</sup> - Base: Brown Box - L: 52 x W: 52 x H: 16,5 cm - 6,35 kg - 0,045 m<sup>3</sup>  
Material: Base in casted aluminum center in powder coated black aluminum. Tabletop in oak veneer.  
Color: Oak, Black oak  
Production time: 2 weeks

604164  
Oak

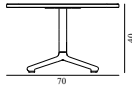

### Lunar Coffee Table H40 Ø70 cm Black Alu/ Marble

Colli: 1  
Size & Weight: H: 40 x Ø: 70 cm - 22,05 kg  
Packing:  
Material: Base in casted aluminum center in powder coated black aluminum. Tabletop in polished marble.  
Color: Black, White, Sand, Coffee  
Production time: 2 weeks

604165  
Marble

## LUNAR TABLE H45 CM ALU

Design: Simon Legald, 2021  
Duty Code: 9403890090  
Made in: Denmark

Construction: Lunar table consist of a casted aluminum center-base with four legs available in polished aluminum or powder coated black aluminum. The tabletop comes in black marble, white marble, oak veneer or black painted oak veneer. Lunar table is available in two heights. The marble tabletops are treated with a surface treatment that penetrates into the material and thereby provides a long-term protection. The surface should not be exposed to acidic foods or beverages, which can leave stains on the surface.

Maintenance: Clean with a damp cloth.

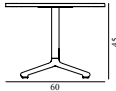

### Lunar Coffee Table H45 Ø60 cm Alu/ Oak

Colli: 1  
Size & Weight: H: 45 x Ø: 60 cm - 7,65 kg  
Packing: Tabletop: Brown Box - L: 63 x B: 63 x D: 4,5 cm - 5,5 kg - 0,018 m<sup>3</sup> - Base: Brown Box - L: 52 x W: 52 x H: 16,5 cm - 6,75 kg - 0,045 m<sup>3</sup>  
Material: Base in casted aluminum center in polished aluminum. Tabletop in oak veneer.  
Color: Oak, Black oak  
Production time: 2 weeks

604162  
Oak

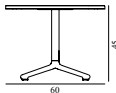

### Lunar Coffee Table H45 Ø60 cm Alu/ Marble

Colli: 1  
Size & Weight: H: 45 x Ø: 60 cm - 16,75 kg  
Packing:  
Material: Base in casted aluminum center in polished aluminum. Tabletop in polished marble.  
Color: Black, White, Sand, Coffee  
Production time: 2 weeks

604163  
Marble

# LUNAR TABLE H45 CM BLACK ALU

Design: Simon Legald, 2021

Duty Code: 9403890090

Made in: Denmark

Construction: Lunar table consist of a casted aluminum center-base with four legs available in polished aluminum or powder coated black aluminum. The tabletop comes in black marble, white marble, oak veneer or black painted oak veneer. Lunar table is available in two heights. The marble tabletops are treated with a surface treatment that penetrates into the material and thereby provides a long-term protection. The surface should not be exposed to acidic foods or beverages, which can leave stains on the surface.

Maintenance: Clean with a damp cloth.

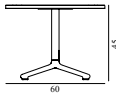

## Lunar Coffee Table H45 Ø60 Black Alu/ Oak

Colli: 1  
 Size & Weight: H: 45 x Ø: 60 cm - 7,65 kg  
 Packing: Tabletop: Brown Box - L: 63 x B: 63 x D: 4,5 cm - 5,5 kg - 0,018 m<sup>3</sup> - Base: Brown Box - L: 52 x W: 52 x H: 16,5 cm - 6,75 kg - 0,045 m<sup>3</sup>  
 Material: Base in casted aluminum center in powder coated black aluminum. Tabletop in oak veneer.  
 Color: Oak, Black oak  
 Production time: 2 weeks

604160  
Oak

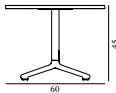

## Lunar Coffee Table H45 Ø60 Black Alu/ Marble

Colli: 1  
 Size & Weight: H: 45 x Ø: 60 cm - 16,75 kg  
 Packing: Tabletop: Brown Box - L: 63 x B: 63 x D: 4,5 cm - 5,5 kg - 0,018 m<sup>3</sup> - Base: Brown Box - L: 52 x W: 52 x H: 16,5 cm - 6,75 kg - 0,045 m<sup>3</sup>  
 Material: Base in casted aluminum center in powder coated black aluminum. Tabletop in polished marble.  
 Color: Black, White, Sand, Coffee  
 Production time: 2 weeks

604161  
Marble

# MY CHAIR WOOD

Design: Nicholai Wiig Hansen, 2013

Awards: Interior Innovation Award – Winner 2014, Germany

Duty Code: 9401690000

Made in: Lithuania

Construction: My Chair consists of a shell made in molded walnut, oak or a painted ash veneer version. Comes with legs in chrome, powder coated steel or molded walnut, oak or painted ash veneer. The rubber pieces between the shell and the legs, as well as the plastic parts underneath the ends of the legs, are specially designed for Normann Copenhagen for My Chair. My Chair with chrome and steel legs are stackable - up to 6 pcs. The chair is delivered assembled. Load capacity: Max. 150 kg dynamic weight. Seat Depth: 42 cm.

Maintenance: Clean with damp cloth.

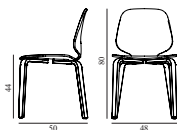

## My Chair Oak

Colli: 1  
 Size & Weight: H: 80 x W: 48 x D: 50 x SH: 44 cm - 6 kg  
 Packing: Brown Box - H: 100 x L: 54 x D: 67 cm - 15,4 kg  
 Material: Shell and Legs: Lacquered Oak Veneer  
 Production time: 4 weeks

 601113  
Oak

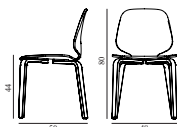

## My Chair Walnut

Colli: 1  
 Size & Weight: H: 80 x W: 48 x D: 50 x SH: 44 cm - 6,2 kg  
 Packing: Brown Box - H: 100 x L: 54 x D: 67 cm - 15,4 kg  
 Material: Shell and Legs: Lacquered Walnut Veneer  
 Production time: 4 weeks

 601115  
Walnut

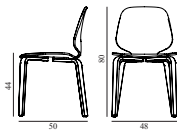

### My Chair Black

Colli: 1  
 Size & Weight: H: 80 x W: 48 x D: 50 x SH: 44 cm - 6,2 kg  
 Packing: Brown Box - H: 100 x L: 54 x D: 67 cm - 15,4 kg  
 Material: Shell and Legs: Painted and Lacquered Ash Veneer  
 Production time: 4 weeks



601116  
Black

## MY CHAIR CHROME & STEEL

Design: Nicholai Wiig Hansen, 2013  
 Awards: Interior Innovation Award – Winner 2014, Germany  
 Duty Code: 9401790000  
 Made in: Lithuania  
 Construction: My Chair consists of a shell made in molded walnut, oak or a painted ash veneer version. Comes with legs in chrome, powder coated steel or molded walnut, oak or painted ash veneer. The rubber pieces between the shell and the legs, as well as the plastic parts underneath the ends of the legs, are specially designed for Normann Copenhagen for My Chair. My Chair with chrome and steel legs are stackable - up to 6 pcs. The chair is delivered assembled. Load capacity: Max. 150 kg dynamic weight. Seat Depth: 42 cm.  
 Maintenance: Clean with damp cloth.

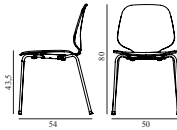

### My Chair Chrome & Oak

Colli: 1  
 Size & Weight: H: 80 x W: 50 x D: 54 x SH: 43,5 cm - 6 kg  
 Packing: Brown Box - H: 100 x L: 54 x D: 67 cm (2 pcs)  
 Material: Shell: Lacquered Oak Veneer; Legs: Chrome  
 Production time: 4 weeks

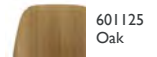

601125  
Oak

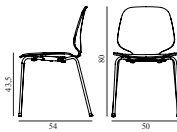

### My Chair Chrome & Walnut

Colli: 1  
 Size & Weight: H: 80 x W: 50 x D: 54 x SH: 43,5 cm - 6 kg  
 Packing: Brown Box - H: 100 x L: 54 x D: 67 cm (2 pcs)  
 Material: Shell: Lacquered Walnut Veneer; Legs: Chrome  
 Production time: 4 weeks

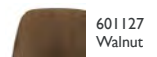

601127  
Walnut

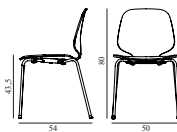

### My Chair Chrome & Black

Colli: 1  
 Size & Weight: H: 80 x W: 50 x D: 54 x SH: 43,5 cm - 6 kg  
 Packing: Brown Box - H: 100 x L: 54 x D: 67 cm (2 pcs)  
 Material: Shell: Painted and Lacquered Ash Veneer; Legs: Chrome  
 Production time: 4 weeks

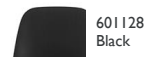

601128  
Black

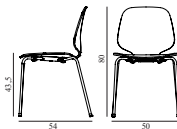

### My Chair Black Steel & Oak

Colli: 1  
 Size & Weight: H: 80 x W: 50 x D: 54 x SH: 43,5 cm - 6 kg  
 Packing: Brown Box - H: 100 x L: 54 x D: 67 cm (2 pcs)  
 Material: Shell: Lacquered Oak Veneer; Legs: Powder Coated Steel  
 Production time: 4 weeks

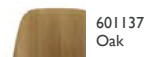

601137  
Oak

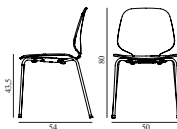

### My Chair Black Steel & Walnut

Colli: 1  
 Size & Weight: H: 80 x W: 50 x D: 54 x SH: 43,5 cm - 6 kg  
 Packing: Brown Box - H: 100 x L: 54 x D: 67 cm (2 pcs)  
 Material: Shell: Lacquered Walnut Veneer; Legs: Powder Coated Steel  
 Production time: 4 weeks



601139  
Walnut

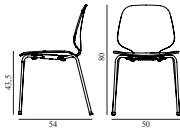

### My Chair Black Steel & Black

Colli: 1  
 Size & Weight: H: 80 x W: 50 x D: 54 x SH: 43,5 cm - 6 kg  
 Packing: Brown Box - H: 100 x L: 54 x D: 67 cm (2 pcs)  
 Material: Shell: Painted and Lacquered Ash Veneer, Legs: Powder Coated Steel  
 Production time: 4 weeks

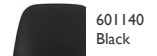

## MY CHAIR FRONT UPHOLSTERY WOOD

Design: Nicholai Wiig Hansen, 2013  
 Duty Code: 9401590000  
 Made in: Lithuania

Construction: My Chair Front Upholstery consists of a shell made in molded walnut, oak or in a painted ash veneer version with PU foam and textile or leather upholstery. Legs option in chrome, powder coated steel or molded walnut, oak or painted ash veneer. The rubber pieces between the shell and the legs, as well as the plastic parts underneath the ends of the legs, are specially designed for Normann Copenhagen for My Chair. My Chair with chrome and steel legs are stackable - up to 6 pcs. Be aware this can harm the upholstery. The chair is delivered assembled. Load capacity: Max. 150 kg dynamic weight.

Maintenance: Textile: Clean with textile or upholstery cleaner. Leather: Clean with damp cloth. Use warm water with soap flakes. Frequent vacuuming with a soft fitting is recommended for both textile and leather to preserve color and appearance.

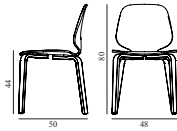

### My Chair Front Upholstery Oak

Colli: 1  
 Size & Weight: H: 80 x W: 48 x D: 50 x SH: 44 cm - 6,6 kg  
 Packing: Brown Box - H: 100 x L: 54 x D: 67 cm - 9,6 kg  
 Material: Shell: Lacquered Oak Veneer, PU Foam and Front Upholstery, Legs: Lacquered Oak Veneer  
 Production time: 6 weeks

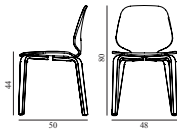

### My Chair Front Upholstery Walnut

Colli: 1  
 Size & Weight: H: 80 x W: 48 x D: 50 x SH: 44 cm - 6,6 kg  
 Packing: Brown Box - H: 100 x L: 54 x D: 67 cm - 9,6 kg  
 Material: Shell: Lacquered Walnut Veneer, PU Foam and Front Upholstery, Legs: Lacquered Walnut Veneer  
 Production time: 6 weeks

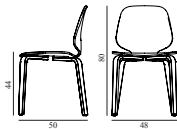

### My Chair Front Upholstery Black

Colli: 1  
 Size & Weight: H: 80 x W: 48 x D: 50 x SH: 44 cm - 6,6 kg  
 Packing: Brown Box - H: 100 x L: 54 x D: 67 cm - 9,6 kg  
 Material: Shell: Painted and Lacquered Ash Veneer, PU Foam and Front Upholstery, Legs: Painted and Lacquered Ash Veneer  
 Color: Black.  
 Production time: 6 weeks

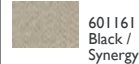
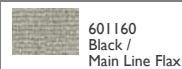



# MY CHAIR FRONT UPHOLSTERY STEEL

Design: Nicholai Wiig Hansen, 2013

Duty Code: 9401710000

Made in: Lithuania

Construction: My Chair Front Upholstery consists of a shell made in molded walnut or oak with a clear lacquer or in a painted ash veneer version with PU foam and textile or leather upholstery. Legs option in chrome, powder coated steel or molded walnut or oak. The rubber pieces between the shell and the legs, as well as the plastic parts underneath the ends of the legs, are specially designed for Normann Copenhagen for My Chair. My Chair with chrome and steel legs are stackable - up to 6 pcs. Be aware this can harm the upholstery. The chair is delivered assembled. Load capacity: Max. 150 kg dynamic weight.

Maintenance: Textile: Clean with textile or upholstery cleaner. Leather: Clean with damp cloth. Use warm water with soap flakes. Frequent vacuuming with a soft fitting is recommended for both textile and leather to preserve color and appearance.

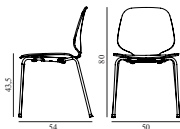

## My Chair Front Upholstery Chrome & Oak

Colli: 1  
 Size & Weight: H: 80 x W: 50 x D: 54 x SH: 43,5 cm - 6 kg  
 Packing: Brown Box - H: 100 x L: 54 x D: 67 cm  
 Material: Shell: Lacquered Oak Veneer, PU Foam and Front Upholstery,  
 Legs: Chrome  
 Production time: 6 weeks

 601187  
 Oak /  
 Main Line Flax

 601188  
 Oak /  
 Synergy

 601189  
 Oak /  
 Ultra Leather

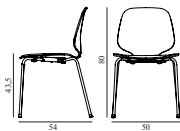

## My Chair Front Upholstery Chrome & Walnut

Colli: 1  
 Size & Weight: H: 80 x W: 50 x D: 54 x SH: 43,5 cm - 6,1 kg  
 Packing: Brown Box - H: 100 x L: 54 x D: 67 cm  
 Material: Shell: Lacquered Walnut Veneer, PU Foam and Front Upholstery,  
 Legs: Chrome  
 Production time: 6 weeks

 601193  
 Walnut /  
 Main Line Flax

 601194  
 Walnut /  
 Synergy

 601195  
 Walnut /  
 Ultra Leather

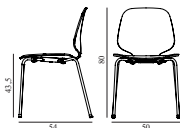

## My Chair Front Upholstery Chrome & Black

Colli: 1  
 Size & Weight: H: 80 x W: 50 x D: 54 x SH: 43,5 cm - 6,1 kg  
 Packing: Brown Box - H: 100 x L: 54 x D: 67 cm  
 Material: Shell: Painted and Lacquered Ash Veneer, PU Foam and Front  
 Upholstery, Legs: Chrome  
 Production time: 6 weeks

 601196  
 Black /  
 Main Line Flax

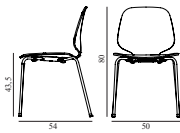

 601197  
 Black /  
 Synergy

 601198  
 Black /  
 Ultra Leather



### My Chair Front Upholstery Black Steel & Oak

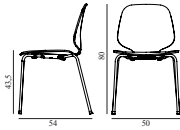

Colli: 1  
 Size & Weight: H: 80 x W: 50 x D: 54 x SH: 43,5 cm - 6 kg  
 Packing: Brown Box - H: 100 x L: 54 x D: 67 cm  
 Material: Shell: Lacquered Oak Veneer; PU Foam and Front Upholstery,  
 Legs: Powder Coated Steel  
 Production time: 6 weeks

	601223 Oak / Main Line Flax
	601224 Oak / Synergy
	601225 Oak / Ultra Leather



### My Chair Front Upholstery Black Steel & Walnut

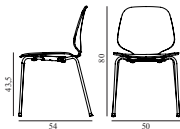

Colli: 1  
 Size & Weight: H: 80 x W: 50 x D: 54 x SH: 43,5 cm - 6 kg  
 Packing: Brown Box - H: 100 x L: 54 x D: 67 cm  
 Material: Shell: Lacquered Walnut Veneer; PU Foam and Front Upholstery,  
 Legs: Powder Coated Steel  
 Production time: 6 weeks

	601229 Walnut / Main Line Flax
	601230 Walnut / Synergy
	601231 Walnut / Ultra Leather



### My Chair Front Upholstery Black Steel & Black

Colli: 1  
 Size & Weight: H: 80 x W: 50 x D: 54 x SH: 43,5 cm - 5,9 kg  
 Packing: Brown Box - H: 100 x L: 54 x D: 67 cm  
 Material: Shell: Painted and Lacquered Ash Veneer; PU Foam and Front  
 Upholstery, Legs: Powder Coated Steel  
 Production time: 6 weeks

	601232 Black / Main Line Flax
	601233 Black / Synergy
	601234 Black / Ultra Leather

# MY CHAIR FULL UPHOLSTERY WOOD

Design: Nicholai Wiig Hansen, 2013

Duty Code: 9401610000

Made in: Lithuania

Construction: My Chair Full Upholstery consists of a shell made of molded oak veneer with PU foam and textile or leather upholstery. Legs option in chrome, powder coated steel, molded walnut, oak or painted ash veneer. The rubber pieces between the shell and the legs, as well as the plastic parts underneath the ends of the legs, are specially designed for Normann Copenhagen for My Chair. My Chair with chrome and steel legs are stackable - up to 6 pcs. Be aware this can harm the upholstery. The chair is delivered assembled. Load capacity: Max. 150 kg dynamic weight.

Maintenance: Textile: Clean with textile or upholstery cleaner. Leather: Clean with damp cloth. Use warm water with soap flakes. Frequent vacuuming with a soft fitting is recommended for both textile and leather to preserve color and appearance.

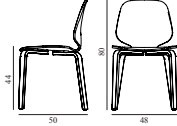

## My Chair Full Upholstery Oak

Colli: 1  
 Size & Weight: H: 80 x W: 48 x D: 50 x SH: 44 cm - 6,3 kg  
 Packing: Brown Box - H: 100 x L: 54 x D: 67 cm - 15,6 kg  
 Material: Shell: Oak Veneer, PU Foam and Full Upholstery, Legs: Lacquered Oak Veneer  
 Production time: 6 weeks

 601259  
Main Line flax

 601260  
Synergy

 601261  
Ultra Leather

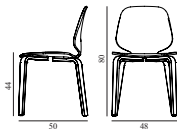

## My Chair Full Upholstery Walnut

Colli: 1  
 Size & Weight: H: 80 x W: 48 x D: 50 x SH: 44 cm - 6,3 kg  
 Packing: Brown Box - H: 100 x L: 54 x D: 67 cm - 15,6 kg  
 Material: Shell: Oak Veneer, PU Foam and Full Upholstery, Legs: Lacquered Walnut Veneer  
 Production time: 6 weeks

 601265  
Main Line flax

 601266  
Synergy

 601267  
Ultra Leather

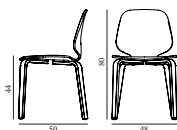

## My Chair Full Upholstery Black

Colli: 1  
 Size & Weight: H: 80 x W: 48 x D: 50 x SH: 44 cm - 6,3 kg  
 Packing: Brown Box - H: 100 x L: 54 x D: 67 cm - 15,6 kg  
 Material: Shell: Oak Veneer, PU Foam and Full Upholstery, Legs: Painted and Lacquered Ash Veneer  
 Production time: 6 weeks

 601268  
Main Line flax

 601269  
Synergy

 601270  
Ultra Leather

# MY CHAIR FULL UPHOLSTERY STEEL

Design: Nicholai Wiig Hansen, 2013

Duty Code: 9401710000

Made in: Lithuania

Construction: My Chair Full Upholstery consists of a shell made of molded oak veneer with PU foam and textile or leather upholstery. Legs option in chrome, powder coated steel or molded walnut or oak veneer. The rubber pieces between the shell and the legs, as well as the plastic parts underneath the ends of the legs, are specially designed for Normann Copenhagen for My Chair. My Chair with chrome and steel legs are stackable - up to 6 pcs. Be aware this can harm the upholstery. The chair is delivered assembled. Load capacity: Max. 150 kg dynamic weight.

Maintenance: Textile: Clean with textile or upholstery cleaner. Leather: Clean with damp cloth. Use warm water with soap flakes. Frequent vacuuming with a soft fitting is recommended for both textile and leather to preserve color and appearance.

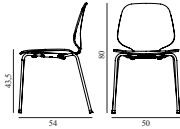

## My Chair Full Upholstery Chrome

Colli: 1  
 Size & Weight: H: 80 x W: 50 x D: 50 x SH: 43,5 cm - 6,2 kg  
 Packing: Brown Box - H: 100 x L: 54 x D: 67 cm - 9,4 kg  
 Material: Shell: Oak Veneer, PU Foam and Full Upholstery, Legs: Chrome  
 Production time: 6 weeks

 601292  
Main Line flax

 601293  
Synergy

 601294  
Ultra Leather

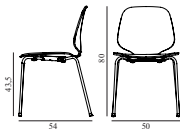

## My Chair Full Upholstery Black Steel

Colli: 1  
 Size & Weight: H: 80 x W: 50 x D: 50 x SH: 43,5 cm - 6,2 kg  
 Packing: Brown Box - H: 100 x L: 54 x D: 67 cm - 9,4 kg  
 Material: Shell: Oak Veneer, PU Foam and Full Upholstery, Legs: Powder Coated Steel  
 Production time: 6 weeks

 601295  
Main Line flax

 601296  
Synergy

 601297  
Ultra Leather

# MY CHAIR LOUNGE WOOD

Design: Nicholai Wiig Hansen, 2013

Duty Code: 9401690000

Made in: Lithuania

Construction: My Chair Lounge consists of a shell made in molded walnut, oak or in a painted ash veneer version. Comes with legs in molded walnut, oak or painted ash veneer. The rubber pieces between the shell and the legs as well as the plastic parts underneath the ends of the legs are specially designed for Normann Copenhagen for My Chair. The chair is delivered assembled. Load capacity: Max. 150 kg dynamic weight.

Maintenance: Clean with damp cloth.

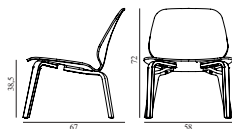

## My Chair Lounge Oak

Colli: 1  
 Size & Weight: H: 72 x W: 58 x D: 67 x SH: 38,5 cm - 7,9 kg  
 Packing: Brown Box - H: 76,5 x L: 67 x D: 62,5 cm - 11,1 kg  
 Material: Shell and Legs: Lacquered Oak Veneer  
 Production time: 4 weeks

 601299  
Oak

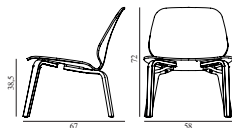

### My Chair Lounge Walnut

Colli: 1  
 Size & Weight: H: 72 x W: 58 x D: 67 x SH: 38,5 cm - 7,9 kg  
 Packing: Brown Box - H: 76,5 x L: 67 x D: 62,5 cm - 11,1 kg  
 Material: Shell and Legs: Lacquered Walnut Veneer  
 Production time: 4 weeks

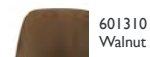

601310  
Walnut

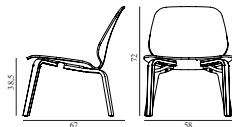

### My Chair Lounge Black

Colli: 1  
 Size & Weight: H: 72 x W: 58 x D: 67 x SH: 38,5 cm - 7,9 kg  
 Packing: Brown Box - H: 76,5 x L: 67 x D: 62,5 cm - 11,1 kg  
 Material: Shell and Legs: Painted and Lacquered Ash Veneer  
 Production time: 4 weeks



601311  
Black

## MY CHAIR LOUNGE FRONT UPHOLSTERY WOOD

Design: Nicholai Wiig Hansen, 2013  
 Duty Code: 9401610000  
 Made in: Lithuania

Construction: My Chair Lounge Front Upholstery consists of a shell made in molded walnut, oak or in a painted ash veneer version with PU foam and textile or leather upholstery. Leg options in molded walnut, oak or painted ash veneer. The rubber pieces between the shell and the legs, as well as the plastic parts underneath the ends of the legs, are specially designed for Normann Copenhagen for My Chair. The chair is delivered assembled. Load capacity: Max. 150 kg dynamic weight.

Maintenance: Textile: Clean with textile or upholstery cleaner. Leather: Clean with damp cloth. Use warm water with soap flakes. Frequent vacuuming with a soft fitting is recommended for both textile and leather to preserve color and appearance.

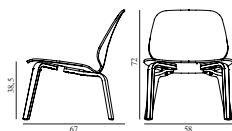

### My Chair Lounge Front Upholstery Oak

Colli: 1  
 Size & Weight: H: 72 x W: 58 x D: 67 x SH: 38,5 cm - 8,9 kg  
 Packing: Brown Box - H: 76,5 x L: 67 x D: 62,5 cm - 11,9 kg  
 Material: Shell: Lacquered Oak Veneer; PU Foam and Front Upholstery, Legs: Lacquered Oak Veneer  
 Production time: 6 weeks



601322  
Main Line Flax



601323  
Synergy



601324  
Ultra Leather

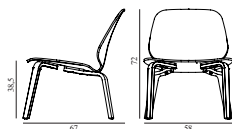

### My Chair Lounge Front Upholstery Walnut

Colli: 1  
 Size & Weight: H: 72 x W: 58 x D: 67 x SH: 38,5 cm - 8,9 kg  
 Packing: Brown Box - H: 76,5 x L: 67 x D: 62,5 cm - 11,9 kg  
 Material: Shell: Lacquered Walnut Veneer; PU Foam and Front Upholstery, Legs: Lacquered Walnut Veneer  
 Production time: 6 weeks



601328  
Main Line Flax



601329  
Synergy



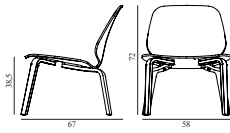

601330  
Ultra Leather



### My Chair Lounge Front Upholstery Black

Colli: 1  
 Size & Weight: H: 72 x W: 58 x D: 67 x SH: 38,5 cm - 8,9 kg  
 Packing: Brown Box - H: 76,5 x L: 67 x D: 62,5 cm - 11,9 kg  
 Material: Shell: Painted and Lacquered Ash Veneer, PU Foam and Front Upholstery, Legs: Painted and Lacquered Ash Veneer  
 Production time: 6 weeks

	601331 Black / Main Line Flax
	601332 Black / Synergy
	601333 Black / Ultra Leather

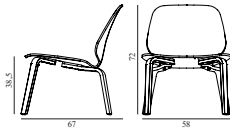

## MY CHAIR LOUNGE FULL UPHOLSTERY

**Design:** Nicholai Wiig Hansen, 2013  
**Duty Code:** 9401610000  
**Made in:** Lithuania  
**Construction:** My Chair Lounge Full Upholstery consists of a shell made of molded oak veneer with PU foam and textile or leather upholstery. Leg options in molded walnut, oak or painted ash veneer. The rubber pieces between the shell and the legs, as well as the plastic parts underneath the ends of the legs, are specially designed for Normann Copenhagen for My Chair. The chair is delivered assembled. Load capacity: Max. 150 kg dynamic weight.  
**Maintenance:** Textile: Clean with textile or upholstery cleaner. Leather: Clean with damp cloth. Use warm water with soap flakes. Frequent vacuuming with a soft fitting is recommended for both textile and leather to preserve color and appearance.



### My Chair Lounge Full Upholstery Oak

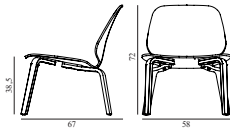

Colli: 1  
 Size & Weight: H: 72 x W: 58 x D: 67 x SH: 38,5 cm - 9,8 kg  
 Packing: Brown Box - H: 76,5 x L: 67 x D: 62,5 cm - 12,8 kg  
 Material: Shell: Oak Veneer, PU Foam and Full Upholstery, Legs: Lacquered Oak Veneer  
 Production time: 6 weeks

	601358 Main Line flax
	601359 Synergy
	601360 Ultra Leather



### My Chair Lounge Full Upholstery Walnut

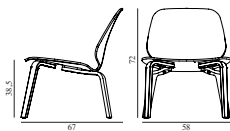

Colli: 1  
 Size & Weight: H: 72 x W: 58 x D: 67 x SH: 38,5 cm - 9,8 kg  
 Packing: Brown Box - H: 76,5 x L: 67 x D: 62,5 cm - 12,8 kg  
 Material: Shell: Oak Veneer, PU Foam and Full Upholstery, Legs: Lacquered Walnut Veneer  
 Production time: 6 weeks

	601364 Main Line flax
	601365 Synergy
	601366 Ultra Leather



### My Chair Lounge Full Upholstery Black

Colli: 1  
 Size & Weight: H: 72 x W: 58 x D: 67 x SH: 38,5 cm - 9 kg  
 Packing: Brown Box - H: 76,5 x L: 67 x D: 62,5 cm - 12 kg  
 Material: Shell: Oak Veneer, PU Foam and Full Upholstery, Legs: Painted and Lacquered Ash Veneer  
 Production time: 6 weeks

	601367 Main Line flax
	601368 Synergy
	601369 Ultra Leather

## MY CHAIR BARSTOOL 65 CM WOOD

Design: Nicholai Wiig Hansen, 2013

Duty Code: 9401690000

Made in: Lithuania

Construction: My Chair Barstool 65 cm consists of a shell made in molded walnut, oak or in a painted ash veneer version. Comes with legs in chrome legs in chrome, powder coated steel, molded walnut, oak or painted ash veneer. The rubber pieces between the shell and the legs, as well as the plastic parts underneath the ends of the legs, are specially designed for Normann Copenhagen for My Chair. My Chair Barstool with chrome and steel legs are stackable - up to 6 pcs. The chair is delivered assembled. Load capacity: Max. 150 kg dynamic weight. Seat Depth: 42 cm.

Maintenance: Clean with damp cloth.

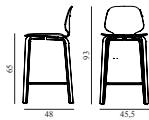

### My Chair Barstool 65 cm Oak

Colli: 1  
Size & Weight: H: 93 x W: 45,5 x D: 48 x SH: 65 cm - 6,2 kg  
Packing: Brown Box - H: 97 x L: 55 x D: 50,5 cm - 9 kg  
Material: Shell and Legs: Lacquered Oak Veneer  
Production time: 4 weeks



601392  
Oak

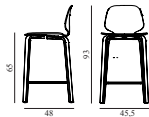

### My Chair Barstool 65 cm Walnut

Colli: 1  
Size & Weight: H: 93 x W: 45,5 x D: 48 x SH: 65 cm - 6,2 kg  
Packing: Brown Box - H: 97 x L: 55 x D: 50,5 cm - 9 kg  
Material: Shell and Legs: Lacquered Walnut Veneer  
Production time: 4 weeks



601394  
Walnut

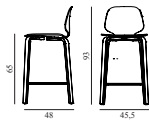

### My Chair Barstool 65 cm Black

Colli: 1  
Size & Weight: H: 93 x W: 45,5 x D: 48 x SH: 65 cm - 6,2 kg  
Packing: Brown Box - H: 97 x L: 55 x D: 50,5 cm - 9 kg  
Material: Shell and Legs: Painted and Lacquered Ash Veneer  
Production time: 4 weeks



601395  
Black

## MY CHAIR BARSTOOL 65 CM CHROME & STEEL

Design: Nicholai Wiig Hansen, 2013

Duty Code: 9401790000

Made in: Lithuania

Construction: My Chair Barstool 65 cm consists of a shell made in molded walnut, oak or in a painted ash veneer version. Comes with legs in chrome legs in chrome, powder coated steel, molded walnut, oak or painted ash veneer. The rubber pieces between the shell and the legs, as well as the plastic parts underneath the ends of the legs, are specially designed for Normann Copenhagen for My Chair. My Chair Barstool with chrome and steel legs are stackable - up to 6 pcs. The chair is delivered assembled. Load capacity: Max. 150 kg dynamic weight. Seat Depth: 42 cm.

Maintenance: Clean with damp cloth.

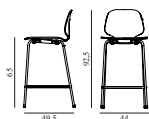

### My Chair Barstool 65 cm Chrome & Oak

Colli: 1  
Size & Weight: H: 92,5 x W: 44 x D: 49,5 x SH: 65 cm - 6 kg  
Packing: Brown Box - H: 97 x L: 55 x D: 50,5 cm  
Material: Shell: Lacquered Oak Veneer; Legs: Chrome  
Production time: 4 weeks



601404  
Oak

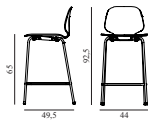

### My Chair Barstool 65 cm Chrome & Walnut

Colli: 1  
Size & Weight: H: 92,5 x W: 44 x D: 49,5 x SH: 65 cm - 6 kg  
Packing: Brown Box - H: 97 x L: 55 x D: 50,5 cm  
Material: Shell: Lacquered Walnut Veneer, Legs: Chrome  
Production time: 4 weeks

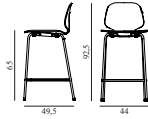

### My Chair Barstool 65 cm Chrome & Black

Colli: 1  
Size & Weight: H: 92,5 x W: 44 x D: 49,5 x SH: 65 cm - 6 kg  
Packing: Brown Box - H: 97 x L: 55 x D: 50,5 cm  
Material: Shell: Painted and Lacquered Ash Veneer, Legs: Chrome  
Production time: 4 weeks

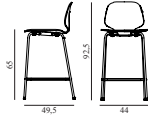

### My Chair Barstool 65 cm Black Steel & Oak

Colli: 1  
Size & Weight: H: 92,5 x W: 44 x D: 49,5 x SH: 65 cm - 6 kg  
Packing: Brown Box - H: 97 x L: 55 x D: 50,5 cm  
Material: Shell: Lacquered Oak Veneer, Legs: Powder Coated Steel  
Production time: 4 weeks

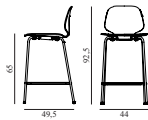
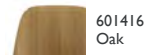

### My Chair Barstool 65 cm Black Steel & Walnut

Colli: 1  
Size & Weight: H: 92,5 x W: 44 x D: 49,5 x SH: 65 cm - 6 kg  
Packing: Brown Box - H: 97 x L: 55 x D: 50,5 cm  
Material: Shell: Lacquered Walnut Veneer, Legs: Powder Coated Steel  
Production time: 4 weeks

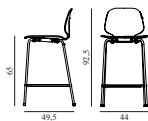

### My Chair Barstool 65 cm Black Steel & Black

Colli: 1  
Size & Weight: H: 92,5 x W: 44 x D: 49,5 x SH: 65 cm - 6 kg  
Packing: Brown Box - H: 97 x L: 55 x D: 50,5 cm  
Material: Shell: Painted and Lacquered Ash Veneer, Legs: Powder Coated Steel  
Production time: 4 weeks





# MY CHAIR BARSTOOL 65 CM FRONT UPHOLSTERY WOOD

Design: Nicholai Wiig Hansen, 2013

Duty Code: 9401590000

Made in: Lithuania

Construction: My Chair Barstool 65 cm Front Upholstery consists of a shell made in molded walnut, oak or in a painted ash veneer version with PU foam and textile or leather upholstery. Leg options in chrome, powder coated steel, molded walnut, oak or painted ash veneer. The rubber pieces between the shell and the legs, as well as the plastic parts underneath the ends of the legs, are specially designed for Normann Copenhagen for My Chair. My Chair Barstool with chrome and steel legs are stackable - up to 6 pcs. Be aware this can harm the upholstery. The chair is delivered assembled. Load capacity: Max. 150 kg dynamic weight.

Maintenance: Textile: Clean with textile or upholstery cleaner. Leather: Clean with damp cloth. Use warm water with soap flakes. Frequent vacuuming with a soft fitting is recommended for both textile and leather to preserve color and appearance.

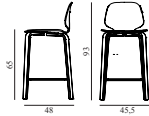

## My Chair Barstool 65 cm Front Upholstery Oak

Colli: 1  
 Size & Weight: H: 93 x W: 45,5 x D: 48 x SH: 65 cm - 6,2 kg  
 Packing: Brown Box - H: 97 x L: 55 x D: 50,5 cm  
 Material: Shell: Lacquered Oak Veneer, PU Foam and Front Upholstery,  
 Legs: Lacquered Oak Veneer  
 Production time: 6 weeks

 601430  
Main Line Flax

 601431  
Synergy

 601432  
Ultra Leather

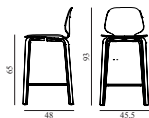

## My Chair Barstool 65 cm Front Upholstery Walnut

Colli: 1  
 Size & Weight: H: 93 x W: 45,5 x D: 48 x SH: 65 cm - 6,2 kg  
 Packing: Brown Box - H: 97 x L: 55 x D: 50,5 cm  
 Material: Shell: Lacquered Walnut Veneer, PU Foam and Front Upholstery,  
 Legs: Lacquered Walnut Veneer  
 Production time: 6 weeks

 601436  
Main Line Flax

 601437  
Synergy

 601438  
Ultra Leather

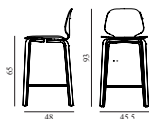

## My Chair Barstool 65 cm Front Upholstery Black

Colli: 1  
 Size & Weight: H: 93 x W: 45,5 x D: 48 x SH: 65 cm - 6,2 kg  
 Packing: Brown Box - H: 97 x L: 55 x D: 50,5 cm  
 Material: Shell: Painted and Lacquered Ash Veneer, PU Foam and Front  
 Upholstery, Legs: Painted and Lacquered Ash Veneer  
 Production time: 6 weeks

 601439  
Black /  
Main Line Flax

 601440  
Black /  
Synergy

 601441  
Black /  
Ultra Leather

# MY CHAIR BARSTOOL 65 CM FRONT UPHOLSTERY STEEL

Design: Nicholai Wiig Hansen, 2013

Duty Code: 9401710000

Made in: Lithuania

Construction: My Chair Barstool 65 cm Front Upholstery consists of a shell made in molded walnut, oak or in a painted ash veneer version with PU foam and textile or leather upholstery. Leg options in chrome, powder coated steel, molded walnut, oak or painted ash veneer. The rubber pieces between the shell and the legs, as well as the plastic parts underneath the ends of the legs, are specially designed for Normann Copenhagen for My Chair. My Chair Barstool with chrome and steel legs are stackable - up to 6 pcs. Be aware this can harm the upholstery. The chair is delivered assembled. Load capacity: Max. 150 kg dynamic weight.

Maintenance: Textile: Clean with textile or upholstery cleaner. Leather: Clean with damp cloth. Use warm water with soap flakes. Frequent vacuuming with a soft fitting is recommended for both textile and leather to preserve color and appearance.

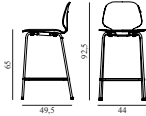

## My Chair Barstool 65 cm Front Upholstery Chrome & Oak

Colli: 1  
 Size & Weight: H: 92,5 x W: 44 x D: 49,5 x SH: 65 cm - 6,3 kg  
 Packing: Brown Box - H: 97 x L: 55 x D: 50,5 cm  
 Material: Shell: Lacquered Oak Veneer, PU Foam and Front Upholstery,  
 Legs: Chrome  
 Production time: 6 weeks

 601466  
 Oak /  
 Main Line Flax

 601467  
 Oak /  
 Synergy

 601468  
 Oak /  
 Ultra Leather

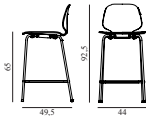

## My Chair Barstool 65 cm Front Upholstery Chrome & Walnut

Colli: 1  
 Size & Weight: H: 92,5 x W: 44 x D: 49,5 x SH: 65 cm - 6,3 kg  
 Packing: Brown Box - H: 97 x L: 55 x D: 50,5 cm  
 Material: Shell: Lacquered Walnut Veneer, PU Foam and Front Upholstery,  
 Legs: Chrome  
 Production time: 6 weeks

 601472  
 Walnut /  
 Main Line Flax

 601473  
 Walnut /  
 Synergy

 601474  
 Walnut /  
 Ultra Leather

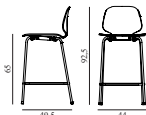

## My Chair Barstool 65 cm Front Upholstery Chrome & Black

Colli: 1  
 Size & Weight: H: 92,5 x W: 44 x D: 49,5 x SH: 65 cm - 6,3 kg  
 Packing: Brown Box - H: 97 x L: 55 x D: 50,5 cm  
 Material: Shell: Painted and Lacquered Ash Veneer, PU Foam and Front  
 Upholstery, Legs: Chrome  
 Production time: 6 weeks

 601475  
 Black /  
 Main Line Flax

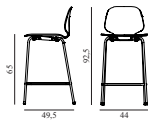

 601476  
 Black /  
 Synergy

 601477  
 Black /  
 Ultra Leather



### My Chair Barstool 65 cm Front Upholstery Black Steel & Oak

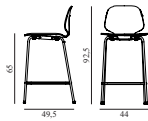

Colli: 1  
 Size & Weight: H: 92,5 x W: 44 x D: 49,5 x SH: 65 cm - 6,3 kg  
 Packing: Brown Box - H: 97 x L: 55 x D: 50,5 cm  
 Material: Shell: Lacquered Oak Veneer, PU Foam and Front Upholstery,  
 Legs: Powder Coated Steel  
 Production time: 6 weeks

	601502 Oak / Main Line Flax
	601503 Oak / Synergy
	601504 Oak / Ultra Leather



### My Chair Barstool 65 cm Front Upholstery Black Steel & Walnut

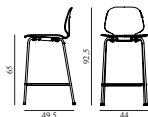

Colli: 1  
 Size & Weight: H: 92,5 x W: 44 x D: 49,5 x SH: 65 cm - 6,3 kg  
 Packing: Brown Box - H: 97 x L: 55 x D: 50,5 cm  
 Material: Shell: Lacquered Walnut Veneer, PU Foam and Front Upholstery,  
 Legs: Powder Coated Steel  
 Production time: 6 weeks

	601508 Walnut / Main Line Flax
	601509 Walnut / Synergy
	601510 Walnut / Ultra Leather



### My Chair Barstool 65 cm Front Upholstery Black Steel & Black

Colli: 1  
 Size & Weight: H: 92,5 x W: 44 x D: 49,5 x SH: 65 cm - 6,3 kg  
 Packing: Brown Box - H: 97 x L: 55 x D: 50,5 cm  
 Material: Shell: Painted and Lacquered Ash Veneer, PU Foam and Front  
 Upholstery, Legs: Powder Coated Steel  
 Production time: 6 weeks

	601511 Black / Main Line Flax
	601512 Black / Synergy
	601513 Black / Ultra Leather

# MY CHAIR BARSTOOL 65 CM FULL UPHOLSTERY WOOD

Design: Nicholai Wiig Hansen, 2013

Duty Code: 9401610000

Made in: Lithuania

Construction: My Chair Barstool 65 cm Full Upholstery consists of a shell made of molded oak veneer with PU foam and textile or leather upholstery. Leg options in chrome, powder coated steel, molded walnut, oak or painted ash veneer. The rubber pieces between the shell and the legs, as well as the plastic parts underneath the ends of the legs, are specially designed for Normann Copenhagen for My Chair. My Chair Barstool with chrome and steel legs are stackable - up to 6 pcs. Be aware this can harm the upholstery. The chair is delivered assembled. Load capacity: Max. 150 kg dynamic weight.

Maintenance: Textile: Clean with textile or upholstery cleaner. Leather: Clean with damp cloth. Use warm water with soap flakes. Frequent vacuuming with a soft fitting is recommended for both textile and leather to preserve color and appearance.

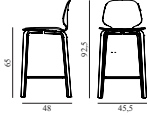

## My Chair Barstool 65 cm Full Upholstery Oak

Colli: 1  
 Size & Weight: H: 92,5 x W: 45,5 x D: 48 x SH: 65 cm - 6,3 kg  
 Packing: Brown Box - H: 97 x L: 55 x D: 50,5 cm - 9,1 kg  
 Material: Shell: Oak Veneer, PU Foam and Full Upholstery, Legs: Lacquered Oak Veneer  
 Production time: 6 weeks

 601538  
Main Line flax

 601539  
Synergy

 601540  
Ultra Leather

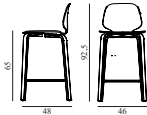

## My Chair Barstool 65 cm Full Upholstery Walnut

Colli: 1  
 Size & Weight: H: 92,5 x W: 45,5 x D: 48 x SH: 65 cm - 6,3 kg  
 Packing: Brown Box - H: 97 x L: 55 x D: 50,5 cm - 9,1 kg  
 Material: Shell: Oak Veneer, PU Foam and Full Upholstery, Legs: Lacquered Walnut Veneer  
 Production time: 6 weeks

 601544  
Main Line flax

 601545  
Synergy

 601546  
Ultra Leather

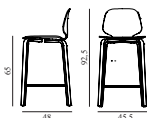

## My Chair Barstool 65 cm Full Upholstery Black

Colli: 1  
 Size & Weight: H: 92,5 x W: 45,5 x D: 48 x SH: 65 cm - 6,3 kg  
 Packing: Brown Box - H: 97 x L: 55 x D: 50,5 cm - 9,1 kg  
 Material: Shell: Oak Veneer, PU Foam and Full Upholstery, Legs: Painted and Lacquered Ash Veneer  
 Production time: 6 weeks

 601547  
Main Line flax

 601548  
Synergy

 601549  
Ultra Leather

# MY CHAIR BARSTOOL 65 CM FULL UPHOLSTERY STEEL

Design: Nicholai Wiig Hansen, 2013

Duty Code: 9401710000

Made in: Lithuania

Construction: My Chair Barstool 65 cm Full Upholstery consists of a shell made of molded oak veneer with PU foam and textile or leather upholstery. Leg options in chrome, powder coated steel or molded walnut or oak veneer. The rubber pieces between the shell and the legs, as well as the plastic parts underneath the ends of the legs, are specially designed for Normann Copenhagen for My Chair. My Chair Barstool with chrome and steel legs are stackable - up to 6 pcs. Be aware this can harm the upholstery. The chair is delivered assembled. Load capacity: Max. 150 kg dynamic weight.

Maintenance: Textile: Clean with textile or upholstery cleaner. Leather: Clean with damp cloth. Use warm water with soap flakes. Frequent vacuuming with a soft fitting is recommended for both textile and leather to preserve color and appearance.

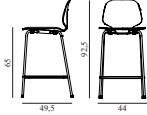

## My Chair Barstool 65 cm Full Upholstery Black Steel

Colli: 1  
 Size & Weight: H: 92,5 x W: 44 x D: 49,5 x SH: 65 cm - 7 kg  
 Packing: Brown Box - H: 97 x L: 55 x D: 50,5 cm - 9,8 kg  
 Material: Shell: Oak Veneer, PU Foam and Full Upholstery, Legs: Powder Coated Steel  
 Production time: 6 weeks

 601574  
Main Line flax

 601575  
Synergy

 601576  
Ultra Leather

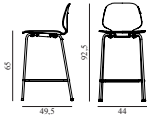

## My Chair Barstool 65 cm Full Upholstery Chrome

Colli: 1  
 Size & Weight: H: 92,5 x W: 44 x D: 49,5 x SH: 65 cm - 7 kg  
 Packing: Brown Box - H: 97 x L: 55 x D: 50,5 cm - 9,8 kg  
 Material: Shell: Oak Veneer, PU Foam and Full Upholstery, Legs: Chrome  
 Production time: 6 weeks

 601571  
Main Line flax

 601572  
Synergy

 601573  
Ultra Leather

# MY CHAIR BARSTOOL 75 CM WOOD

Design: Nicholai Wiig Hansen, 2013

Duty Code: 9401690000

Made in: Lithuania

Construction: My Chair Barstool 75 cm consists of a shell made in molded walnut, oak or in a painted ash veneer version. Comes with legs in chrome legs in chrome, powder coated steel, molded walnut or painted ash veneer. The rubber pieces between the shell and the legs, as well as the plastic parts underneath the ends of the legs, are specially designed for Normann Copenhagen for My Chair. My Chair Barstool with chrome and steel legs are stackable - up to 6 pcs. The chair is delivered assembled. Load capacity: Max. 150 kg dynamic weight. Seat Depth: 42 cm.

Maintenance: Clean with damp cloth.

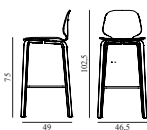

## My Chair Barstool 75 cm Oak

Colli: 1  
 Size & Weight: H: 102,5 x W: 50 x D: 49 x SH: 75 cm - 6,6 kg  
 Packing: Brown Box - H: 108 x L: 55 x D: 50,5 cm - 9 kg  
 Material: Shell and Legs: Lacquered Oak Veneer  
 Production time: 4 weeks

 601578  
Oak

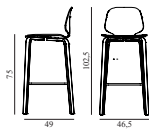

### My Chair Barstool 75 cm Walnut

Colli: 1  
 Size & Weight: H: 102,5 x W: 46,5 x D: 49 x SH: 75 cm - 6,6 kg  
 Packing: Brown Box - H: 108 x L: 55 x D: 50,5 cm - 9 kg  
 Material: Shell and Legs: Lacquered Walnut Veneer  
 Production time: 4 weeks



601580  
Walnut

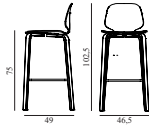

### My Chair Barstool 75 cm Black

Colli: 1  
 Size & Weight: H: 102,5 x W: 46,5 x D: 49 x SH: 75 cm - 6,6 kg  
 Packing: Brown Box - H: 108 x L: 55 x D: 50,5 cm - 9 kg  
 Material: Shell and Legs: Painted and Lacquered Ash Veneer  
 Production time: 4 weeks



601581  
Black

## MY CHAIR BARSTOOL 75 CM CHROME & STEEL

Design: Nicholai Wiig Hansen, 2013

Duty Code: 9401790000

Made in: Lithuania

Construction: My Chair Barstool 75 cm consists of a shell made in molded walnut, oak or in a painted ash veneer version. Comes with legs in chrome legs in chrome, powder coated steel, molded walnut or painted ash veneer. The rubber pieces between the shell and the legs, as well as the plastic parts underneath the ends of the legs, are specially designed for Normann Copenhagen for My Chair. My Chair Barstool with chrome and steel legs are stackable - up to 6 pcs. The chair is delivered assembled. Load capacity: Max. 150 kg dynamic weight. Seat Depth: 42 cm.

Maintenance: Clean with damp cloth.

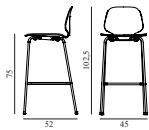

### My Chair Barstool 75 cm Chrome & Oak

Colli: 1  
 Size & Weight: H: 102,5 x W: 45 x D: 52 x SH: 75 cm - 6,4 kg  
 Packing: Brown Box - H: 108 x L: 55 x D: 50,5 cm  
 Material: Shell: Lacquered Oak Veneer, Legs: Chrome  
 Production time: 4 weeks



601590  
Oak

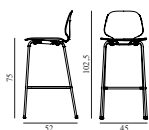

### My Chair Barstool 75 cm Chrome & Walnut

Colli: 1  
 Size & Weight: H: 102,5 x W: 45 x D: 52 x SH: 75 cm - 6,4 kg  
 Packing: Brown Box - H: 108 x L: 55 x D: 50,5 cm  
 Material: Shell: Lacquered Walnut Veneer, Legs: Chrome  
 Production time: 4 weeks



601592  
Walnut

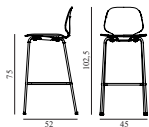

### My Chair Barstool 75 cm Chrome & Black

Colli: 1  
 Size & Weight: H: 102,5 x W: 45 x D: 52 x SH: 75 cm - 6,4 kg  
 Packing: Brown Box - H: 108 x L: 55 x D: 50,5 cm  
 Material: Shell: Painted and Lacquered Ash Veneer, Legs: Chrome  
 Production time: 4 weeks



601593  
Black

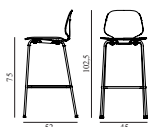

### My Chair Barstool 75 cm Black Steel & Oak

Colli: 1  
 Size & Weight: H: 102,5 x W: 45 x D: 52 x SH: 75 cm - 6,4 kg  
 Packing: Brown Box - H: 108 x L: 55 x D: 50,5 cm  
 Material: Shell: Lacquered Oak Veneer, Legs: Powder Coated Steel  
 Production time: 4 weeks



601602  
Oak

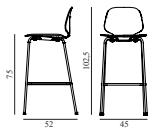

### My Chair Barstool 75 cm Black Steel & Walnut

Colli: 1  
 Size & Weight: H: 102,5 x W: 45 x D: 52 x SH: 75 cm - 6,4 kg  
 Packing: Brown Box - H: 108 x L: 55 x D: 50,5 cm  
 M3: 0,3  
 Material: Shell: Lacquered Walnut Veneer, Legs: Powder Coated Steel  
 Production time: 4 weeks



601604  
Walnut

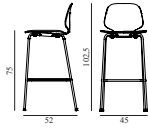

### My Chair Barstool 75 cm Black Steel & Black

Colli: 1  
 Size & Weight: H: 102,5 x W: 45 x D: 52 x SH: 75 cm - 6,4 kg  
 Packing: Brown Box - H: 108 x L: 55 x D: 50,5 cm  
 Material: Shell: Painted and Lacquered Ash Veneer, Legs: Powder Coated Steel  
 Production time: 4 weeks



601605  
Black

## MY CHAIR BARSTOOL 75 CM FRONT UPHOLSTERY WOOD

Design: Nicholai Wiig Hansen, 2013  
 Duty Code: 9401590000  
 Made in: Lithuania

Construction: My Chair Barstool 75 cm Front Upholstery consists of a shell made in molded walnut, oak or in a painted ash veneer version with PU foam and textile or leather upholstery. Leg options in chrome, powder coated steel or molded walnut or oak. The rubber pieces between the shell and the legs, as well as the plastic parts underneath the ends of the legs, are specially designed for Normann Copenhagen for My Chair. My Chair Barstool with chrome and steel legs are stackable - up to 6 pcs. Be aware this can harm the upholstery. The chair is delivered assembled. Load capacity: Max. 150 kg dynamic weight.

Maintenance: Textile: Clean with textile or upholstery cleaner. Leather: Clean with damp cloth. Use warm water with soap flakes. Frequent vacuuming with a soft fitting is recommended for both textile and leather to preserve color and appearance.

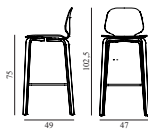

### My Chair Barstool 75 cm Front Upholstery Oak

Colli: 1  
 Size & Weight: H: 102,5 x W: 47 x D: 49 x SH: 75 cm - 7,3 kg  
 Packing: Brown Box - H: 108 x L: 55 x D: 50,5 cm  
 Material: Shell: Lacquered Oak Veneer, PU Foam and Front Upholstery, Legs: Lacquered Oak Veneer  
 Production time: 6 weeks



601616  
Main Line Flax



601617  
Synergy



601618  
Ultra Leather

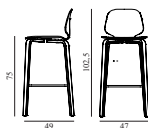

### My Chair Barstool 75 cm Front Upholstery Walnut

Colli: 1  
 Size & Weight: H: 102,5 x W: 47 x D: 49 x SH: 75 cm - 7,3 kg  
 Packing: Brown Box - H: 108 x L: 55 x D: 50,5 cm  
 Material: Shell: Lacquered Walnut Veneer, PU Foam and Front Upholstery, Legs: Lacquered Walnut Veneer  
 Production time: 6 weeks



601622  
Main Line Flax



601623  
Synergy



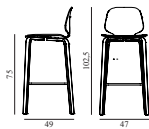

601624  
Ultra Leather



### My Chair Barstool 75 cm Front Upholstery Black

Colli: 1  
 Size & Weight: H: 102,5 x W: 47 x D: 49 x SH: 75 cm - 7,3 kg  
 Packing: Brown Box - H: 108 x L: 55 x D: 50,5 cm  
 Material: Shell: Painted and Lacquered Ash Veneer, PU Foam and Front Upholstery, Legs: Painted and Lacquered Ash Veneer  
 Production time: 6 weeks

	601625 Main Line Flax
	601626 Synergy
	601627 Ultra Leather

## MY CHAIR BARSTOOL 75 CM FRONT UPHOLSTERY STEEL

Design: Nicholai Wiig Hansen, 2013  
 Duty Code: 9403601000  
 Made in: Lithuania

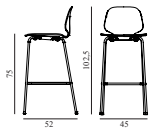

Construction: My Chair Barstool 75 cm Front Upholstery consists of a shell made in molded walnut or oak veneer with a clear lacquer or in a painted ash veneer version with PU foam and textile or leather upholstery. Leg options in chrome, powder coated steel or molded walnut or oak. The rubber pieces between the shell and the legs, as well as the plastic parts underneath the ends of the legs, are specially designed for Normann Copenhagen for My Chair. My Chair Barstool with chrome and steel legs are stackable - up to 6 pcs. Be aware this can harm the upholstery. The chair is delivered assembled. Load capacity: Max. 150 kg dynamic weight.

Maintenance: Textile: Clean with textile or upholstery cleaner. Leather: Clean with damp cloth. Use warm water with soap flakes. Frequent vacuuming with a soft fitting is recommended for both textile and leather to preserve color and appearance.



### My Chair Barstool 75 cm Front Upholstery Chrome & Oak

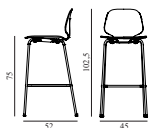

Colli: 1  
 Size & Weight: H: 102,5 x W: 45 x D: 52 x SH: 75 cm - 7,2 kg  
 Packing: Brown Box - H: 108 x L: 55 x D: 50,5 cm  
 Material: Shell: Lacquered Oak Veneer, PU Foam and Front Upholstery, Legs: Chrome  
 Production time: 6 weeks

	601652 Oak / Main Line Flax
	601653 Oak / Synergy
	601654 Oak / Ultra Leather



### My Chair Barstool 75 cm Front Upholstery Chrome & Walnut

Colli: 1  
 Size & Weight: H: 102,5 x W: 45 x D: 52 x SH: 75 cm - 7,2 kg  
 Packing: Brown Box - H: 108 x L: 55 x D: 50,5 cm  
 Material: Shell: Lacquered Walnut Veneer, PU Foam and Front Upholstery, Legs: Chrome  
 Production time: 6 weeks



	601658 Walnut / Main Line Flax
	601659 Walnut / Synergy
	601660 Walnut / Ultra Leather

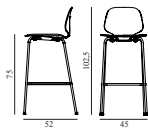



### My Chair Barstool 75 cm Front Upholstery Chrome & Black

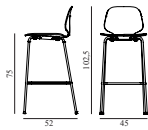

Colli: 1  
 Size & Weight: H: 102,5 x W: 45 x D: 52 x SH: 75 cm - 7,2 kg  
 Packing: Brown Box - H: 108 x L: 55 x D: 50,5 cm  
 Material: Shell: Painted and Lacquered Ash Veneer, PU Foam and Front Upholstery, Legs: Chrome  
 Production time: 6 weeks

	601661 Black / Main Line Flax
	601662 Black / Synergy
	601663 Black / Ultra Leather



### My Chair Barstool 75 cm Front Upholstery Black Steel & Oak

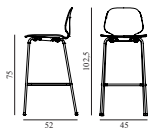

Colli: 1  
 Size & Weight: H: 102,5 x W: 45 x D: 52 x SH: 75 cm - 7,2 kg  
 Packing: Brown Box - H: 108 x L: 55 x D: 50,5 cm  
 Material: Shell: Lacquered Oak Veneer, PU Foam and Front Upholstery, Legs: Powder Coated Steel  
 Production time: 6 weeks

	601688 Oak / Main Line Flax
	601689 Oak / Synergy
	601690 Oak / Ultra Leather



### My Chair Barstool 75 cm Front Upholstery Black Steel & Walnut

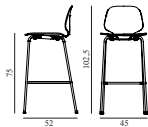

Colli: 1  
 Size & Weight: H: 102,5 x W: 45 x D: 52 x SH: 75 cm - 7,2 kg  
 Packing: Brown Box - H: 108 x L: 55 x D: 50,5 cm  
 M3: 0,3  
 Material: Shell: Lacquered Walnut Veneer, PU Foam and Front Upholstery, Legs: Powder Coated Steel  
 Production time: 6 weeks

	601694 Walnut / Main Line Flax
	601695 Walnut / Synergy
	601696 Walnut / Ultra Leather



### My Chair Barstool 75 cm Front Upholstery Black Steel & Black

Colli: 1  
 Size & Weight: H: 102,5 x W: 45 x D: 52 x SH: 75 cm - 7,2 kg  
 Packing: Brown Box - H: 108 x L: 55 x D: 50,5 cm  
 Material: Shell: Painted and Lacquered Ash Veneer, PU Foam and Front Upholstery, Legs: Powder Coated Steel  
 Production time: 6 weeks

	601697 Black / Main Line Flax
	601698 Black / Synergy
	601699 Black / Ultra Leather

# MY CHAIR BARSTOOL 75 CM FULL UPHOLSTERY WOOD

Design: Nicholai Wiig Hansen, 2013

Duty Code: 9401610000

Made in: Lithuania

Construction: My Chair Barstool 75 cm Full Upholstery consists of a shell made of molded oak veneer with PU foam and textile or leather upholstery. Leg options in chrome, powder coated steel, molded walnut, oak or painted ash veneer. The rubber pieces between the shell and the legs, as well as the plastic parts underneath the ends of the legs, are specially designed for Normann Copenhagen for My Chair. My Chair Barstool with chrome and steel legs are stackable - up to 6 pcs. Be aware this can harm the upholstery. The chair is delivered assembled. Load capacity: Max. 150 kg dynamic weight.

Maintenance: Textile: Clean with textile or upholstery cleaner. Leather: Clean with damp cloth. Use warm water with soap flakes. Frequent vacuuming with a soft fitting is recommended for both textile and leather to preserve color and appearance.

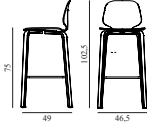

## My Chair Barstool 75 cm Full Upholstery Oak

Colli: 1  
 Size & Weight: H: 102,5 x W: 46,5 x D: 49 x SH: 75 cm - 7,5 kg  
 Packing: Brown Box - H: 108 x L: 55 x D: 50,5 cm  
 Material: Shell: Oak Veneer, PU Foam and Full Upholstery, Legs: Lacquered Oak Veneer  
 Production time: 6 weeks

 601724  
Main Line flax

 601725  
Synergy

 601726  
Ultra Leather

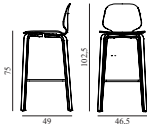

## My Chair Barstool 75 cm Full Upholstery Walnut

Colli: 1  
 Size & Weight: H: 102,5 x W: 46,5 x D: 49 x SH: 75 cm - 7,5 kg  
 Packing: Brown Box - H: 108 x L: 55 x D: 50,5 cm  
 Material: Shell: Oak Veneer, PU Foam and Full Upholstery, Legs: Lacquered Walnut Veneer  
 Production time: 6 weeks

 601730  
Main Line flax

 601731  
Synergy

 601732  
Ultra Leather

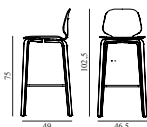

## My Chair Barstool 75 cm Full Upholstery Black

Colli: 1  
 Size & Weight: H: 102,5 x W: 46,5 x D: 49 x SH: 75 cm - 7,5 kg  
 Packing: Brown Box - H: 108 x L: 55 x D: 50,5 cm  
 Material: Shell: Oak Veneer, PU Foam and Full Upholstery, Legs: Painted and Lacquered Ash Veneer  
 Production time: 6 weeks

 601739  
Main Line flax

 601740  
Synergy

 601741  
Ultra Leather

# MY CHAIR BARSTOOL 75 CM FULL UPHOLSTERY STEEL

Design: Nicholai Wiig Hansen, 2013

Duty Code: 9401710000

Made in: Lithuania

Construction: My Chair Barstool 75 cm Full Upholstery consists of a shell made of molded oak veneer with PU foam and textile or leather upholstery. Leg options in chrome, powder coated steel or molded walnut or oak veneer. The rubber pieces between the shell and the legs, as well as the plastic parts underneath the ends of the legs, are specially designed for Normann Copenhagen for My Chair. My Chair Barstool with chrome and steel legs are stackable - up to 6 pcs. Be aware this can harm the upholstery. The chair is delivered assembled. Load capacity: Max. 150 kg dynamic weight.

Maintenance: Textile: Clean with textile or upholstery cleaner. Leather: Clean with damp cloth. Use warm water with soap flakes. Frequent vacuuming with a soft fitting is recommended for both textile and leather to preserve color and appearance.

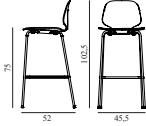

## My Chair Barstool 75 cm Full Upholstery Chrome

Colli: 1  
 Size & Weight: H: 102,5 x W: 45,5 x D: 52 x SH: 75 cm - 7,4 kg  
 Packing: Brown Box - H: 108 x L: 55 x D: 50,5 cm - 10,6 kg  
 Material: Shell: Oak Veneer, PU Foam and Full Upholstery, Legs: Chrome  
 Production time: 6 weeks

 601733  
Main Line flax

 601734  
Synergy

 601735  
Ultra Leather

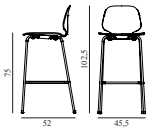

## My Chair Barstool 75 cm Full Upholstery Black Steel

Colli: 1  
 Size & Weight: H: 102,5 x W: 45,5 x D: 52 x SH: 75 cm - 7,4 kg  
 Packing: Brown Box - H: 108 x L: 55 x D: 50,5 cm - 10,6 kg  
 Material: Shell: Oak Veneer, PU Foam and Full Upholstery, Legs: Powder Coated Steel  
 Production time: 6 weeks

 601736  
Main Line flax

 601737  
Synergy

 601738  
Ultra Leather

# MY CHAIR GLIDES

Duty Code: 9401990090

Construction: Different types of flooring require different types of glides.

Maintenance: We recommend to check the glides every 3-6 months. If worn down, please replace.

## My Chair & Barstool Glides

 900094  
PE for steel /  
Black /  
4pcs

 900095  
PE for steel w. felt /  
Black /  
4pcs

 900096  
PE for wood /  
Black /  
4pcs

 900097  
PE for wood w. felt /  
Black /  
4pcs

# MY CHAIR LINK

Design: Simon Legald, 2017  
Duty Code: 9401999090

## My Chair Link

900098  
Black

# OFF CHAIR LOW 4L

Design: Simon Legald, 2022  
Duty Code: 9401710000  
Made in: Lithuania

Construction: Off Chair consists of a seat made from rigid PU foam with full upholstery. Inside the upholstery and PU foam, the chair has a steel reinforcement structure. The base comes with either four static legs or five wheels with swivel and a tilt inclination of 10°, and is made of polished or black powder-coated aluminum. An optional cushion made of veneer and PU foam is available.

Maintenance: Textile: Clean with textile or upholstery cleaner. Leather: Clean with damp cloth. Use warm water with soap flakes. Frequent vacuuming with a soft fitting is recommended for both textile and leather to preserve color and appearance.

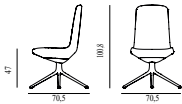

## Off Chair Low 4L Alu

Colli: 1  
Size & Weight: H: 100,8 x W: 70,5 x D: 70,5 x SH: 47 cm - 13,5 kg  
Packing: Brown Box - H: 110 x L: 69 x D: 72 cm - 14,5 kg  
M3: 0,5465  
Material: Seat: Rigid PU foam and full upholstery with a steel reinforcement structure inside. Legs and armrests: Polished aluminum or black powder coated aluminum.  
Color: All colors in Kvadrat Reflect, Kvadrat Remix, Kvadrat Canvas, Kvadrat Steelcut Trio, Kvadrat Hallingdal, Kvadrat Divina, Kvadrat Divina MD, Kvadrat Divina Melange, Kvadrat Fiord, Kvadrat Vidar and Sørensen Ultra Leather.  
Production time: 5 weeks

 605332  
Ultra Leather

 607381  
Remix

 607382  
Canvas

 607383  
Steelcut Trio

 607384  
Hallingdal

 607385  
Divina

 607386  
Divina MD

 607387  
Divina Melange

 607388  
Fiord

 607389  
Vidar

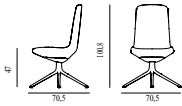

### Off Chair Low 4L Black Alu

Colli: 1  
 Size & Weight: H: 100,8 x W: 70,5 x D: 70,5 x SH: 47 cm - 13,5 kg  
 Packing: Brown Box - H: 110 x L: 69 x D: 72 cm - 14,5 kg  
 M3: 0,5465  
 Material: Seat: Rigid PU foam and full upholstery with a steel reinforcement structure inside. Legs and armrests: Polished aluminum or black powder coated aluminum.  
 Color: All colors in Kvadrat Reflect, Kvadrat Remix, Kvadrat Canvas, Kvadrat Steelcut Trio, Kvadrat Hallingdal, Kvadrat Divina, Kvadrat Divina MD, Kvadrat Divina Melange, Kvadrat Fiord, Kvadrat Vidar and Sørensen Ultra Leather.  
 Production time: 5 weeks

	605339 Ultra Leather
	607391 Remix
	607392 Canvas
	607393 Steelcut Trio
	607394 Hallingdal
	607395 Divina
	607396 Divina MD
	607397 Divina Melange
	607398 Fiord
	607399 Vidar

# OFF CHAIR LOW 4L WITH CUSHION

Design: Simon Legald, 2022

Duty Code: 9401710000

Made in: Lithuania

Construction: Off Chair consists of a seat made from rigid PU foam with full upholstery. Inside the upholstery and PU foam, the chair has a steel reinforcement structure. The base comes with either four static legs or five wheels with swivel and a tilt inclination of 10°, and is made of polished or black powder-coated aluminum. An optional cushion made of veneer and PU foam is available.

Maintenance: Textile: Clean with textile or upholstery cleaner. Leather: Clean with damp cloth. Use warm water with soap flakes. Frequent vacuuming with a soft fitting is recommended for both textile and leather to preserve color and appearance.



## Off Chair Low 4L Alu With Cushion

Colli: 1  
 Size & Weight: H: 100,8 x W: 70,5 x D: 70,5 x SH: 47 cm - 13,8 kg  
 Packing: Brown Box - H: 110 x L: 69 x D: 72 cm - 14,8 kg  
 M3: 0,5465  
 Material: Seat: Rigid PU foam and full upholstery with a steel reinforcement structure inside. Legs and armrests: Polished aluminum or black powder coated aluminum. Cushion: Veneer and PU foam.  
 Color: All colors in Kvadrat Reflect, Kvadrat Remix, Kvadrat Canvas, Kvadrat Steelcut Trio, Kvadrat Hallingdal, Kvadrat Divina, Kvadrat Divina MD, Kvadrat Divina Melange, Kvadrat Fiord, Kvadrat Vidar and Sørensen Ultra Leather.  
 Production time: 5 weeks

	605388 Ultra Leather
	607461 Remix
	607462 Canvas
	607463 Steelcut Trio
	607464 Hallingdal
	607465 Divina
	607466 Divina MD
	607467 Divina Melange
	607468 Fiord
	607469 Vidar



### Off Chair Low 4L Black Alu With Cushion

Colli: 1  
 Size & Weight: H: 100,8 x W: 70,5 x D: 70,5 x SH: 47 cm - 13,8 kg  
 Packing: Brown Box - H: 110 x L: 69 x D: 72 cm - 14,8 kg  
 M3: 0,5465  
 Material: Seat: Rigid PU foam and full upholstery with a steel reinforcement structure inside. Legs and armrests: Polished aluminum or black powder coated aluminum. Cushion: Veneer and PU foam.  
 Color: All colors in Kvadrat Reflect, Kvadrat Remix, Kvadrat Canvas, Kvadrat Steelcut Trio, Kvadrat Hallingdal, Kvadrat Divina, Kvadrat Divina MD, Kvadrat Divina Melange, Kvadrat Fiord, Kvadrat Vidar and Sørensen Ultra Leather.  
 Production time: 5 weeks

	605395 Ultra Leather
	607471 Remix
	607472 Canvas
	607473 Steelcut Trio
	607474 Hallingdal
	607475 Divina
	607476 Divina MD
	607477 Divina Melange
	607478 Fiord
	607479 Vidar

# OFF CHAIR LOW 5W GAS LIFT

Design: Simon Legald, 2022

Duty Code: 9401390000

Made in: Lithuania

Construction: Off Chair consists of a seat made from rigid PU foam with full upholstery. Inside the upholstery and PU foam, the chair has a steel reinforcement structure. The base comes with either four static legs or five wheels with swivel and a tilt inclination of 10°, and is made of polished or black powder-coated aluminum. An optional cushion made of veneer and PU foam is available.

Maintenance: Textile: Clean with textile or upholstery cleaner. Leather: Clean with damp cloth. Use warm water with soap flakes. Frequent vacuuming with a soft fitting is recommended for both textile and leather to preserve color and appearance.



## Off Chair Low 5W Gas Lift Alu

Colli: 1  
Size & Weight: H: 100,8 x W: 72,5 x D: 72,5 x SH: 45 cm - 14 kg  
Packing: Brown Box - H: 110 x L: 69 x D: 72 cm - 15 kg  
M3: 0,5465  
Material: Seat: Rigid PU foam and full upholstery with a steel reinforcement structure inside. Legs and armrests: Polished aluminum or black powder coated aluminum with five wheels.  
Color: All colors in Kvadrat Reflect, Kvadrat Remix, Kvadrat Canvas, Kvadrat Steelcut Trio, Kvadrat Hallingdal, Kvadrat Divina, Kvadrat Divina MD, Kvadrat Divina Melange, Kvadrat Fiord, Kvadrat Vidar and Sørensen Ultra Leather.

Production time: 5 weeks

605564  
Ultra Leather

607541  
Remix

607542  
Canvas

607543  
Steelcut Trio

607544  
Hallingdal

607545  
Divina

607546  
Divina MD

607547  
Divina Melange

607548  
Fiord

607549  
Vidar





### Off Chair Low 5W Gas Lift Black Alu

Colli: 1  
 Size & Weight: H: 100,8 x W: 72,5 x D: 72,5 x SH: 45 cm - 14 kg  
 Packing: Brown Box - H: 110 x L: 69 x D: 72 cm - 15 kg  
 M3: 0,5465  
 Material: Seat: Rigid PU foam and full upholstery with a steel reinforcement structure inside. Legs and armrests: Polished aluminum or black powder coated aluminum with five wheels.  
 Color: All colors in Kvadrat Reflect, Kvadrat Remix, Kvadrat Canvas, Kvadrat Steelcut Trio, Kvadrat Hallingdal, Kvadrat Divina, Kvadrat Divina MD, Kvadrat Divina Melange, Kvadrat Fiord, Kvadrat Vidar and Sørensen Ultra Leather.  
 Production time: 5 weeks

	605571 Ultra Leather
	607551 Remix
	607552 Canvas
	607553 Steelcut Trio
	607554 Hallingdal
	607555 Divina
	607556 Divina MD
	607557 Divina Melange
	607558 Fiord
	607559 Vidar

# OFF CHAIR LOW 5W GAS LIFT WITH CUSHION

Design: Simon Legald, 2022

Duty Code: 9401390000

Made in: Lithuania

Construction: Off Chair consists of a seat made from rigid PU foam with full upholstery. Inside the upholstery and PU foam, the chair has a steel reinforcement structure. The base comes with either four static legs or five wheels with swivel and a tilt inclination of 10°, and is made of polished or black powder-coated aluminum. An optional cushion made of veneer and PU foam is available.

Maintenance: Textile: Clean with textile or upholstery cleaner. Leather: Clean with damp cloth. Use warm water with soap flakes. Frequent vacuuming with a soft fitting is recommended for both textile and leather to preserve color and appearance.



## Off Chair Low 5W Gas Lift Alu With Cushion

Colli: 1  
Size & Weight: H: 100,8 x W: 72,5 x D: 72,5 x SH: 45 cm - 14,3 kg  
Packing: Brown Box - H: 110 x L: 69 x D: 72 cm - 15,3 kg  
M3: 0,5465  
Material: Seat: Rigid PU foam and full upholstery with a steel reinforcement structure inside. Legs and armrests: Polished aluminum or black powder coated aluminum with five wheels. Cushion: Veneer and PU foam.  
Color: All colors in Kvadrat Reflect, Kvadrat Remix, Kvadrat Canvas, Kvadrat Steelcut Trio, Kvadrat Hallingdal, Kvadrat Divina, Kvadrat Divina MD, Kvadrat Divina Melange, Kvadrat Fiord, Kvadrat Vidar and Sørensen Ultra Leather.  
Production time: 5 weeks

	605620 Ultra Leather
	607621 Remix
	607622 Canvas
	607623 Steelcut Trio
	607624 Hallingdal
	607625 Divina
	607626 Divina MD
	607627 Divina Melange
	607628 Fiord
	607629 Vidar



**Off Chair Low 5W Gas Lift Black Alu With Cushion**

Colli: 1  
 Size & Weight: H: 100,8 x W: 72,5 x D: 72,5 x SH: 45 cm - 14,3 kg  
 Packing: Brown Box - H: 110 x L: 69 x D: 72 cm - 15,3 kg  
 M3: 0,5465  
 Material: Seat: Rigid PU foam and full upholstery with a steel reinforcement structure inside. Legs and armrests: Polished aluminum or black powder coated aluminum with five wheels. Cushion: Veneer and PU foam.  
 Color: All colors in Kvadrat Reflect, Kvadrat Remix, Kvadrat Canvas, Kvadrat Steelcut Trio, Kvadrat Hallingdal, Kvadrat Divina, Kvadrat Divina MD, Kvadrat Divina Melange, Kvadrat Fiord, Kvadrat Vidar and Sørensen Ultra Leather.  
 Production time: 5 weeks

	605627 Ultra Leather
	607631 Remix
	607632 Canvas
	607633 Steelcut Trio
	607634 Hallingdal
	607635 Divina
	607636 Divina MD
	607637 Divina Melange
	607638 Fiord
	607639 Vidar

# OFF ARMCHAIR LOW 4L

Design: Simon Legald, 2022

Duty Code: 9401710000

Made in: Lithuania

Construction: Off Chair consists of a seat made from rigid PU foam with full upholstery. Inside the upholstery and PU foam, the chair has a steel reinforcement structure. The base comes with either four static legs or five wheels with swivel and a tilt inclination of 10°, and is made of polished or black powder-coated aluminum. An optional cushion made of veneer and PU foam is available.

Maintenance: Textile: Clean with textile or upholstery cleaner. Leather: Clean with damp cloth. Use warm water with soap flakes. Frequent vacuuming with a soft fitting is recommended for both textile and leather to preserve color and appearance.



## Off Armchair Low 4L Alu

Colli: 1  
Size & Weight: H: 100,8 x W: 70,5 x D: 70,5 x SH: 47 cm - 13,5 kg  
Packing: Brown Box - H: 110 x L: 69 x D: 72 cm - 14,5 kg  
M3: 0,5465  
Material: Seat: Rigid PU foam and full upholstery with a steel reinforcement structure inside. Legs and armrests: Polished aluminum or black powder coated aluminum.  
Color: All colors in Kvadrat Reflect, Kvadrat Remix, Kvadrat Canvas, Kvadrat Steelcut Trio, Kvadrat Hallingdal, Kvadrat Divina, Kvadrat Divina MD, Kvadrat Divina Melange, Kvadrat Fiord, Kvadrat Vidar and Sørensen Ultra Leather.

Production time: 5 weeks

605346  
Ultra Leather

607401  
Remix

607402  
Canvas

607403  
Steelcut Trio

607404  
Hallingdal

607405  
Divina

607406  
Divina MD

607407  
Divina Melange

607408  
Fiord

607409  
Vidar



### Off Armchair Low 4L Black Alu

Colli: 1  
 Size & Weight: H: 100,8 x W: 70,5 x D: 70,5 x SH: 47 cm - 13,5 kg  
 Packing: Brown Box - H: 110 x L: 69 x D: 72 cm - 14,5 kg  
 M3: 0,5465  
 Material: Seat: Rigid PU foam and full upholstery with a steel reinforcement structure inside. Legs and armrests: Polished aluminum or black powder coated aluminum.  
 Color: All colors in Kvadrat Reflect, Kvadrat Remix, Kvadrat Canvas, Kvadrat Steelcut Trio, Kvadrat Hallingdal, Kvadrat Divina, Kvadrat Divina MD, Kvadrat Divina Melange, Kvadrat Fiord, Kvadrat Vidar and Sørensen Ultra Leather.  
 Production time: 5 weeks

	605353 Ultra Leather
	607411 Remix
	607412 Canvas
	607413 Steelcut Trio
	607414 Hallingdal
	607415 Divina
	607416 Divina MD
	607417 Divina Melange
	607418 Fiord
	607419 Vidar

# OFF ARMCHAIR LOW 4L WITH CUSHION

Design: Simon Legald, 2022

Duty Code: 9401710000

Made in: Lithuania

Construction: Off Chair consists of a seat made from rigid PU foam with full upholstery. Inside the upholstery and PU foam, the chair has a steel reinforcement structure. The base comes with either four static legs or five wheels with swivel and a tilt inclination of 10°, and is made of polished or black powder-coated aluminum. An optional cushion made of veneer and PU foam is available.

Maintenance: Textile: Clean with textile or upholstery cleaner. Leather: Clean with damp cloth. Use warm water with soap flakes. Frequent vacuuming with a soft fitting is recommended for both textile and leather to preserve color and appearance.



## Off Armchair Low 4L Alu With Cushion

Colli: 1  
Size & Weight: H: 100,8 x W: 70,5 x D: 70,5 x SH: 47 cm - 13,8 kg  
Packing: Brown Box - H: 110 x L: 60 x D: 72 cm - 14,8 kg  
M3: 0,4752  
Material: Seat: Rigid PU foam and full upholstery with a steel reinforcement structure inside. Legs and armrests: Polished aluminum or black powder coated aluminum.  
Color: All colors in Kvadrat Reflect, Kvadrat Remix, Kvadrat Canvas, Kvadrat Steelcut Trio, Kvadrat Hallingdal, Kvadrat Divina, Kvadrat Divina MD, Kvadrat Divina Melange, Kvadrat Fiord, Kvadrat Vidar and Sørensen Ultra Leather.

Production time: 5 weeks

605522  
Ultra Leather

607481  
Remix

607482  
Canvas

607483  
Steelcut Trio

607484  
Hallingdal

607485  
Divina











607486  
Divina MD

607487  
Divina Melange

607488  
Fiord

607489  
Vidar



<b>Off Armchair Low 4L Black Alu With Cushion</b>	
Colli:	1
Size & Weight:	H: 100,8 x W: 70,5 x D: 70,5 x SH: 47 cm - 13,8 kg
Packing:	Brown Box - H: 110 x L: 69 x D: 72 cm - 14,8 kg
M3:	0,5465
Material:	Seat: Rigid PU foam and full upholstery with a steel reinforcement structure inside. Legs and armrests: Polished aluminum or black powder coated aluminum. Cushion: Veneer and PU foam.
Color:	All colors in Kvadrat Reflect, Kvadrat Remix, Kvadrat Canvas, Kvadrat Steelcut Trio, Kvadrat Hallingdal, Kvadrat Divina, Kvadrat Divina MD, Kvadrat Divina Melange, Kvadrat Fiord, Kvadrat Vidar and Sørensen Ultra Leather.
Production time: 5 weeks	
	605529 Ultra Leather
	607491 Remix
	607492 Canvas
	607493 Steelcut Trio
	607494 Hallingdal
	607495 Divina
	607496 Divina MD
	607497 Divina Melange
	607498 Fiord
	607499 Vidar

# OFF ARMCHAIR LOW 5W GAS LIFT

Design: Simon Legald, 2022

Duty Code: 9401390000

Made in: Lithuania

Construction: Off Chair consists of a seat made from rigid PU foam with full upholstery. Inside the upholstery and PU foam, the chair has a steel reinforcement structure. The base comes with either four static legs or five wheels with swivel and a tilt inclination of 10°, and is made of polished or black powder-coated aluminum. An optional cushion made of veneer and PU foam is available.

Maintenance: Textile: Clean with textile or upholstery cleaner. Leather: Clean with damp cloth. Use warm water with soap flakes. Frequent vacuuming with a soft fitting is recommended for both textile and leather to preserve color and appearance.



## Off Armchair Low 5W Gas Lift Alu

Colli: 1  
Size & Weight: H: 100,8 x W: 72,5 x D: 72,5 x SH: 45 cm - 14 kg  
Packing: Brown Box - H: 110 x L: 69 x D: 72 cm - 15 kg  
M3: 0,5465  
Material: Seat: Rigid PU foam and full upholstery with a steel reinforcement structure inside. Legs and armrests: Polished aluminum or black powder coated aluminum with five wheels.  
Color: All colors in Kvadrat Reflect, Kvadrat Remix, Kvadrat Canvas, Kvadrat Steelcut Trio, Kvadrat Hallingdal, Kvadrat Divina, Kvadrat Divina MD, Kvadrat Divina Melange, Kvadrat Fiord, Kvadrat Vidar and Sørensen Ultra Leather.

Production time: 5 weeks

 605578  
Ultra Leather

 607561  
Remix

 607562  
Canvas

 607563  
Steelcut Trio

 607564  
Hallingdal

 607565  
Divina

 607566  
Divina MD











 607567  
Divina Melange

 607568  
Fiord

 607569  
Vidar





<b>Off Armchair Low 5W Gas Lift Black Alu</b>	
Colli:	1
Size & Weight:	H: 100,8 x W: 72,5 x D: 72,5 x SH: 45 cm - 14 kg
Packing:	Brown Box - H: 110 x L: 69 x D: 72 cm - 15 kg
M3:	0,5465
Material:	Seat: Rigid PU foam and full upholstery with a steel reinforcement structure inside. Legs and armrests: Polished aluminum or black powder coated aluminum with five wheels.
Color:	All colors in Kvadrat Reflect, Kvadrat Remix, Kvadrat Canvas, Kvadrat Steelcut Trio, Kvadrat Hallingdal, Kvadrat Divina, Kvadrat Divina MD, Kvadrat Divina Melange, Kvadrat Fiord, Kvadrat Vidar and Sørensen Ultra Leather.
Production time: 5 weeks	
	605585 Ultra Leather
	607571 Remix
	607572 Canvas
	607573 Steelcut Trio
	607574 Hallingdal
	607575 Divina
	607576 Divina MD
	607577 Divina Melange
	607578 Fiord
	607579 Vidar

# OFF ARMCHAIR LOW 5W GAS LIFT WITH CUSHION

Design: Simon Legald, 2022  
 Duty Code: 9401390000  
 Made in: Lithuania  
 Maintenance: Textile: Clean with textile or upholstery cleaner. Leather: Clean with damp cloth. Use warm water with soap flakes. Frequent vacuuming with a soft fitting is recommended for both textile and leather to preserve color and appearance.



## Off Armchair Low 5W Gas Lift Alu With Cushion

Colli: 1  
 Size & Weight: H: 100,8 x W: 72,5 x D: 72,5 x SH: 45 cm - 14,3 kg  
 Packing: Brown Box - H: 110 x L: 69 x D: 72 cm - 15,3 kg  
 M3: 0,5465  
 Material: Seat: Rigid PU foam and full upholstery with a steel reinforcement structure inside. Legs and armrests: Polished aluminum or black powder coated aluminum with five wheels. Cushion: Veneer and PU foam.  
 Color: All colors in Kvadrat Reflect, Kvadrat Remix, Kvadrat Canvas, Kvadrat Steelcut Trio, Kvadrat Hallingdal, Kvadrat Divina, Kvadrat Divina MD, Kvadrat Divina Melange, Kvadrat Fiord, Kvadrat Vidar and Sørensen Ultra Leather.  
 Production time: 5 weeks

	605634 Ultra Leather
	607641 Remix
	607642 Canvas
	607643 Steelcut Trio
	607644 Hallingdal
	607645 Divina
	607646 Divina MD
	607647 Divina Melange
	607648 Fiord
	607649 Vidar



### Off Armchair Low 5W Gas Lift Black Alu With Cushion

Colli: 1  
 Size & Weight: H: 100,8 x W: 72,5 x D: 72,5 x SH: 45 cm - 14,3 kg  
 Packing: Brown Box - H: 110 x L: 69 x D: 72 cm - 15,3 kg  
 M3: 0,5465  
 Material: Seat: Rigid PU foam and full upholstery with a steel reinforcement structure inside. Legs and armrests: Polished aluminum or black powder coated aluminum with five wheels.  
 Cushion: Veneer and PU foam.  
 Color: All colors in Kvadrat Reflect, Kvadrat Remix, Kvadrat Canvas, Kvadrat Steelcut Trio, Kvadrat Hallingdal, Kvadrat Divina, Kvadrat Divina MD, Kvadrat Divina Melange, Kvadrat Fiord, Kvadrat Vidar and Sørensen Ultra Leather.  
 Production time: 5 weeks

	605641 Ultra Leather
	607651 Remix
	607652 Canvas
	607653 Steelcut Trio
	607654 Hallingdal
	607655 Divina
	607656 Divina MD
	607657 Divina Melange
	607658 Fiord
	607659 Vidar

# OFF CHAIR HIGH 4L

Design: Simon Legald, 2022

Duty Code: 9401710000

Made in: Lithuania

Construction: Off Chair consists of a seat made from rigid PU foam with full upholstery. Inside the upholstery and PU foam, the chair has a steel reinforcement structure. The base comes with either four static legs or five wheels with swivel and a tilt inclination of 10°, and is made of polished or black powder-coated aluminum. An optional cushion made of veneer and PU foam is available.

Maintenance: Textile: Clean with textile or upholstery cleaner. Leather: Clean with damp cloth. Use warm water with soap flakes. Frequent vacuuming with a soft fitting is recommended for both textile and leather to preserve color and appearance.

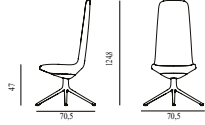

## Off Chair High 4L Alu

Colli: 1  
Size & Weight: H: 124,8 x W: 70,5 x D: 70,5 x SH: 47 cm - 15,2 kg  
Packing: Brown Box - H: 134 x L: 69 x D: 72 cm - 16,2 kg  
M3: 0,6657  
Material: Seat: Rigid PU foam and full upholstery with a steel reinforcement structure inside. Legs and armrests: Polished aluminum or black powder coated aluminum.  
Color: All colors in Kvadrat Reflect, Kvadrat Remix, Kvadrat Canvas, Kvadrat Steelcut Trio, Kvadrat Hallingdal, Kvadrat Divina, Kvadrat Divina MD, Kvadrat Divina Melange, Kvadrat Fiord, Kvadrat Vidar and Sørensen Ultra Leather.

Production time: 5 weeks

	605360 Ultra Leather
	607421 Remix
	607422 Canvas
	607423 Steelcut Trio
	607424 Hallingdal
	607425 Divina
	607426 Divina MD
	607427 Divina Melange
	607428 Fiord
	607429 Vidar

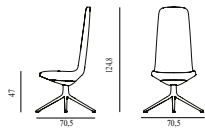

### Off Chair High 4L Black Alu

**Colli:** 1  
**Size & Weight:** H: 124,8 x W: 70,5 x D: 70,5 x SH: 47 cm - 15,2 kg  
**Packing:** Brown Box - H: 134 x L: 69 x D: 72 cm - 16,2 kg  
**M3:** 0,6657  
**Material:** Seat: Rigid PU foam and full upholstery with a steel reinforcement structure inside. Legs and armrests: Polished aluminum or black powder coated aluminum.  
**Color:** All colors in Kvadrat Reflect, Kvadrat Remix, Kvadrat Canvas, Kvadrat Steelcut Trio, Kvadrat Hallingdal, Kvadrat Divina, Kvadrat Divina MD, Kvadrat Divina Melange, Kvadrat Fiord, Kvadrat Vidar and Sørensen Ultra Leather.  
**Production time:** 5 weeks

	605367 Ultra Leather
	607431 Remix
	607432 Canvas
	607433 Steelcut Trio
	607434 Hallingdal
	607435 Divina
	607436 Divina MD
	607437 Divina Melange
	607438 Fiord
	607439 Vidar

# OFF CHAIR HIGH 4L WITH CUSHION

Design: Simon Legald, 2022

Duty Code: 9401710000

Made in: Lithuania

Construction: Off Chair consists of a seat made from rigid PU foam with full upholstery. Inside the upholstery and PU foam, the chair has a steel reinforcement structure. The base comes with either four static legs or five wheels with swivel and a tilt inclination of 10°, and is made of polished or black powder-coated aluminum. An optional cushion made of veneer and PU foam is available.

Maintenance: Textile: Clean with textile or upholstery cleaner. Leather: Clean with damp cloth. Use warm water with soap flakes. Frequent vacuuming with a soft fitting is recommended for both textile and leather to preserve color and appearance.

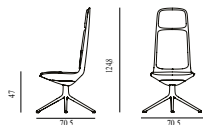

## Off Chair High 4L Alu With Cushion

Colli: 1  
 Size & Weight: H: 124,8 x W: 70,5 x D: 70,5 x SH: 47 cm - 15,5 kg  
 Packing: Brown Box - H: 134 x L: 69 x D: 72 cm - 16,5 kg  
 M3: 0,6657  
 Material: Seat: Rigid PU foam and full upholstery with a steel reinforcement structure inside. Legs and armrests: Polished aluminum or black powder coated aluminum. Cushion: Veneer and PU foam.  
 Color: All colors in Kvadrat Reflect, Kvadrat Remix, Kvadrat Canvas, Kvadrat Steelcut Trio, Kvadrat Hallingdal, Kvadrat Divina, Kvadrat Divina MD, Kvadrat Divina Melange, Kvadrat Fiord, Kvadrat Vidar and Sørensen Ultra Leather.  
 Production time: 5 weeks

	605536 Ultra Leather
	607501 Remix
	607502 Canvas
	607503 Steelcut Trio
	607504 Hallingdal
	607505 Divina
	607506 Divina MD
	607507 Divina Melange
	607508 Fiord
	607509 Vidar



### Off Chair High 4L Black Alu With Cushion

Colli: 1  
 Size & Weight: H: 124,8 x W: 70,5 x D: 70,5 x SH: 47 cm - 15,5 kg  
 Packing: Brown Box - H: 134 x L: 69 x D: 72 cm - 16,5 kg  
 M3: 0,6657  
 Material: Seat: Rigid PU foam and full upholstery with a steel reinforcement structure inside. Legs and armrests: Polished aluminum or black powder coated aluminum. Cushion: Veneer and PU foam.  
 Color: All colors in Kvadrat Reflect, Kvadrat Remix, Kvadrat Canvas, Kvadrat Steelcut Trio, Kvadrat Hallingdal, Kvadrat Divina, Kvadrat Divina MD, Kvadrat Divina Melange, Kvadrat Fiord, Kvadrat Vidar and Sørensen Ultra Leather.  
 Production time: 5 weeks

	605543 Ultra Leather
	607511 Remix
	607512 Canvas
	607513 Steelcut Trio
	607514 Hallingdal
	607515 Divina
	607516 Divina MD
	607517 Divina Melange
	607518 Fiord
	607519 Vidar

# OFF CHAIR HIGH 5W GAS LIFT

Design: Simon Legald, 2022

Duty Code: 9401390000

Made in: Lithuania

Construction: Off Chair consists of a seat made from rigid PU foam with full upholstery. Inside the upholstery and PU foam, the chair has a steel reinforcement structure. The base comes with either four static legs or five wheels with swivel and a tilt inclination of 10°, and is made of polished or black powder-coated aluminum. An optional cushion made of veneer and PU foam is available.

Maintenance: Textile: Clean with textile or upholstery cleaner. Leather: Clean with damp cloth. Use warm water with soap flakes. Frequent vacuuming with a soft fitting is recommended for both textile and leather to preserve color and appearance.

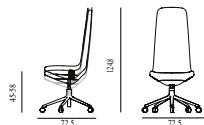

## Off Chair High 5W Gas Lift Alu

Colli: 1  
 Size & Weight: H: 124,8 x W: 72,5 x D: 72,5 x SH: 45 cm - 16,2 kg  
 Packing: Brown Box - H: 134 x L: 69 x D: 72 cm - 17,2 kg  
 M3: 0,6657  
 Material: Seat: Rigid PU foam and full upholstery with a steel reinforcement structure inside. Legs and armrests: Polished aluminum or black powder coated aluminum with five wheels.  
 Color: All colors in Kvadrat Reflect, Kvadrat Remix, Kvadrat Canvas, Kvadrat Steelcut Trio, Kvadrat Hallingdal, Kvadrat Divina, Kvadrat Divina MD, Kvadrat Divina Melange, Kvadrat Fiord, Kvadrat Vidar and Sørensen Ultra Leather.

Production time: 5 weeks

	605592 Ultra Leather
	607581 Remix
	607582 Canvas
	607583 Steelcut Trio
	607584 Hallingdal
	607585 Divina
	607586 Divina MD
	607587 Divina Melange
	607588 Fiord
	607589 Vidar



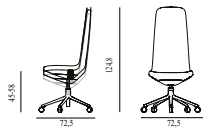

### Off Chair High 5W Gas Lift Black Alu

**Colli:** 1  
**Size & Weight:** H: 124,8 x W: 72,5 x D: 72,5 x SH: 45 cm - 16,2 kg  
**Packing:** Brown Box - H: 134 x L: 69 x D: 72 cm - 17,2 kg  
**M3:** 0,6657  
**Material:** Seat: Rigid PU foam and full upholstery with a steel reinforcement structure inside. Legs and armrests: Polished aluminum or black powder coated aluminum with five wheels.  
**Color:** All colors in Kvadrat Reflect, Kvadrat Remix, Kvadrat Canvas, Kvadrat Steelcut Trio, Kvadrat Hallingdal, Kvadrat Divina, Kvadrat Divina MD, Kvadrat Divina Melange, Kvadrat Fiord, Kvadrat Vidar and Sørensen Ultra Leather.  
**Production time:** 5 weeks

	605599 Ultra Leather
	607591 Remix
	607592 Canvas
	607593 Steelcut Trio
	607594 Hallingdal
	607595 Divina
	607596 Divina MD
	607597 Divina Melange
	607598 Fiord
	607599 Vidar

# OFF CHAIR HIGH 5W GAS LIFT WITH CUSHION

Design: Simon Legald, 2022

Duty Code: 9401390000

Made in: Lithuania

Construction: Off Chair consists of a seat made from rigid PU foam with full upholstery. Inside the upholstery and PU foam, the chair has a steel reinforcement structure. The base comes with either four static legs or five wheels with swivel and a tilt inclination of 10°, and is made of polished or black powder-coated aluminum. An optional cushion made of veneer and PU foam is available.

Maintenance: Textile: Clean with textile or upholstery cleaner. Leather: Clean with damp cloth. Use warm water with soap flakes. Frequent vacuuming with a soft fitting is recommended for both textile and leather to preserve color and appearance.

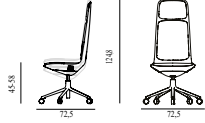

## Off Chair High 5W Gas Lift Alu With Cushion

Colli: 1

Size & Weight: H: 124,8 x W: 72,5 x D: 72,5 x SH: 45 cm - 16,5 kg

Packing: Brown Box - H: 134 x L: 69 x D: 72 cm - 17,5 kg

M3: 0,6657

Material: Seat: Rigid PU foam and full upholstery with a steel reinforcement structure inside. Legs and armrests: Polished aluminum or black powder coated aluminum with five wheels. Cushion: Veneer and PU foam.

Color: All colors in Kvadrat Reflect, Kvadrat Remix, Kvadrat Canvas, Kvadrat Steelcut Trio, Kvadrat Hallingdal, Kvadrat Divina, Kvadrat Divina MD, Kvadrat Divina Melange, Kvadrat Fiord, Kvadrat Vidar and Sørensen Ultra Leather.

Production time: 5 weeks

	605648 Ultra Leather
	607661 Remix
	607662 Canvas
	607663 Steelcut Trio
	607664 Hallingdal
	607665 Divina
	607666 Divina MD
	607667 Divina Melange
	607668 Fiord
	607669 Vidar

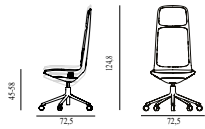

**Off Chair High 5W Gas Lift Black Alu With Cushion**

Colli: 1  
 Size & Weight: H: 124,8 x W: 72,5 x D: 72,5 x SH: 45 cm - 16,5 kg  
 Packing: Brown Box - H: 134 x L: 69 x D: 72 cm - 17,5 kg  
 M3: 0,6657  
 Material: Seat: Rigid PU foam and full upholstery with a steel reinforcement structure inside. Legs and armrests: Polished aluminum or black powder coated aluminum with five wheels.  
 Cushion: Veneer and PU foam.  
 Color: All colors in Kvadrat Reflect, Kvadrat Remix, Kvadrat Canvas, Kvadrat Steelcut Trio, Kvadrat Hallingdal, Kvadrat Divina, Kvadrat Divina MD, Kvadrat Divina Melange, Kvadrat Fiord, Kvadrat Vidar and Sørensen Ultra Leather.

Production time: 5 weeks

	605655 Ultra Leather
	607671 Remix
	607672 Canvas
	607673 Steelcut Trio
	607674 Hallingdal
	607675 Divina
	607676 Divina MD
	607677 Divina Melange
	607678 Fiord
	607679 Vidar

# OFF ARMCHAIR HIGH 4L

Design: Simon Legald, 2022

Duty Code: 9401710000

Made in: Lithuania

Construction: Off Chair consists of a seat made from rigid PU foam with full upholstery. Inside the upholstery and PU foam, the chair has a steel reinforcement structure. The base comes with either four static legs or five wheels with swivel and a tilt inclination of 10°, and is made of polished or black powder-coated aluminum. An optional cushion made of veneer and PU foam is available.

Maintenance: Textile: Clean with textile or upholstery cleaner. Leather: Clean with damp cloth. Use warm water with soap flakes. Frequent vacuuming with a soft fitting is recommended for both textile and leather to preserve color and appearance.

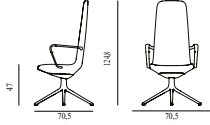

## Off Armchair High 4L Alu

Colli: 1  
Size & Weight: H: 124,8 x W: 70,5 x D: 70,5 x SH: 47 cm - 15,2 kg  
Packing: Brown Box - H: 134 x L: 69 x D: 72 cm - 16,2 kg  
M3: 0,6657  
Material: Seat: Rigid PU foam and full upholstery with a steel reinforcement structure inside. Legs and armrests: Polished aluminum or black powder coated aluminum.  
Color: All colors in Kvadrat Reflect, Kvadrat Remix, Kvadrat Canvas, Kvadrat Steelcut Trio, Kvadrat Hallingdal, Kvadrat Divina, Kvadrat Divina MD, Kvadrat Divina Melange, Kvadrat Fiord, Kvadrat Vidar and Sørensen Ultra Leather.

Production time: 5 weeks

	605374 Ultra Leather
	607441 Remix
	607442 Canvas
	607443 Steelcut Trio
	607444 Hallingdal
	607445 Divina
	607446 Divina MD
	607447 Divina Melange
	607448 Fiord
	607449 Vidar

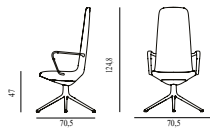

### Off Armchair High 4L Black Alu

Colli: 1  
 Size & Weight: H: 124,8 x W: 70,5 x D: 70,5 x SH: 47 cm - 15,2 kg  
 Packing: Brown Box - H: 134 x L: 69 x D: 72 cm - 16,2 kg  
 M3: 0,6657  
 Material: Seat: Rigid PU foam and full upholstery with a steel reinforcement structure inside. Legs and armrests: Polished aluminum or black powder coated aluminum.  
 Color: All colors in Kvadrat Reflect, Kvadrat Remix, Kvadrat Canvas, Kvadrat Steelcut Trio, Kvadrat Hallingdal, Kvadrat Divina, Kvadrat Divina MD, Kvadrat Divina Melange, Kvadrat Fiord, Kvadrat Vidar and Sørensen Ultra Leather.  
 Production time: 5 weeks

	605381 Ultra Leather
	607451 Remix
	607452 Canvas
	607453 Steelcut Trio
	607454 Hallingdal
	607455 Divina
	607456 Divina MD
	607457 Divina Melange
	607458 Fiord
	607459 Vidar

# OFF ARMCHAIR HIGH 4L WITH CUSHION

Design: Simon Legald, 2022

Duty Code: 9401710000

Made in: Lithuania

Construction: Off Chair consists of a seat made from rigid PU foam with full upholstery. Inside the upholstery and PU foam, the chair has a steel reinforcement structure. The base comes with either four static legs or five wheels with swivel and a tilt inclination of 10°, and is made of polished or black powder-coated aluminum. An optional cushion made of veneer and PU foam is available.

Maintenance: Textile: Clean with textile or upholstery cleaner. Leather: Clean with damp cloth. Use warm water with soap flakes. Frequent vacuuming with a soft fitting is recommended for both textile and leather to preserve color and appearance.



## Off Armchair High 4L Alu With Cushion

Colli: 1

Size & Weight: H: 124,8 x W: 70,5 x D: 70,5 x SH: 47 cm - 15,5 kg

Packing: Brown Box - H: 134 x L: 69 x D: 72 cm - 16,5 kg

M3: 0,6657

Material: Seat: Rigid PU foam and full upholstery with a steel reinforcement structure inside. Legs and armrests: Polished aluminum or black powder coated aluminum. Cushion: Veneer and PU foam.

Color: All colors in Kvadrat Reflect, Kvadrat Remix, Kvadrat Canvas, Kvadrat Steelcut Trio, Kvadrat Hallingdal, Kvadrat Divina, Kvadrat Divina MD, Kvadrat Divina Melange, Kvadrat Fiord, Kvadrat Vidar and Sørensen Ultra Leather.

Production time: 5 weeks

	605550 Ultra Leather
	607521 Remix
	607522 Canvas
	607523 Steelcut Trio
	607524 Hallingdal
	607525 Divina
	607526 Divina MD
	607527 Divina Melange
	607528 Fiord
	607529 Vidar



### Off Armchair High 4L Black Alu With Cushion

Colli: 1  
 Size & Weight: H: 124,8 x W: 70,5 x D: 70,5 x SH: 47 cm - 15,5 kg  
 Packing: Brown Box - H: 134 x L: 69 x D: 72 cm - 16,5 kg  
 M3: 0,6657  
 Material: Seat: Rigid PU foam and full upholstery with a steel reinforcement structure inside. Legs and armrests: Polished aluminum or black powder coated aluminum. Cushion: Veneer and PU foam.  
 Color: All colors in Kvadrat Reflect, Kvadrat Remix, Kvadrat Canvas, Kvadrat Steelcut Trio, Kvadrat Hallingdal, Kvadrat Divina, Kvadrat Divina MD, Kvadrat Divina Melange, Kvadrat Fiord, Kvadrat Vidar and Sørensen Ultra Leather.

Production time: 5 weeks

	605557 Ultra Leather
	607531 Remix
	607532 Canvas
	607533 Steelcut Trio
	607534 Hallingdal
	607535 Divina
	607536 Divina MD
	607537 Divina Melange
	607538 Fiord
	607539 Vidar

# OFF ARMCHAIR HIGH 5W GAS LIFT

Design: Simon Legald, 2022

Duty Code: 9401390000

Made in: Lithuania

Construction: Off Chair consists of a seat made from rigid PU foam with full upholstery. Inside the upholstery and PU foam, the chair has a steel reinforcement structure. The base comes with either four static legs or five wheels with swivel and a tilt inclination of 10°, and is made of polished or black powder-coated aluminum. An optional cushion made of veneer and PU foam is available.

Maintenance: Textile: Clean with textile or upholstery cleaner. Leather: Clean with damp cloth. Use warm water with soap flakes. Frequent vacuuming with a soft fitting is recommended for both textile and leather to preserve color and appearance.

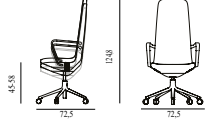

## Off Armchair High 5W Gas Lift Alu

Colli: 1  
Size & Weight: H: 124,8 x W: 72,5 x D: 72,5 x SH: 45 cm - 16,2 kg  
Packing: Brown Box - H: 134 x L: 69 x D: 72 cm - 17,2 kg  
M3: 0,6657  
Material: Seat: Rigid PU foam and full upholstery with a steel reinforcement structure inside. Legs and armrests: Polished aluminum or black powder coated aluminum with five wheels.  
Color: All colors in Kvadrat Reflect, Kvadrat Remix, Kvadrat Canvas, Kvadrat Steelcut Trio, Kvadrat Hallingdal, Kvadrat Divina, Kvadrat Divina MD, Kvadrat Divina Melange, Kvadrat Fiord, Kvadrat Vidar and Sørensen Ultra Leather.

Production time: 5 weeks

605606  
Ultra Leather

607601  
Remix

607602  
Canvas

607603  
Steelcut Trio

607604  
Hallingdal

607605  
Divina

607606  
Divina MD

607607  
Divina Melange

607608  
Fiord

607609  
Vidar



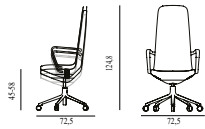

### Off Armchair High 5W Gas Lift Black Alu

**Colli:** 1  
**Size & Weight:** H: 124,8 x W: 72,5 x D: 72,5 x SH: 45 cm - 16,2 kg  
**Packing:** Brown Box - H: 134 x L: 69 x D: 72 cm - 17,2 kg  
**M3:** 0,6657  
**Material:** Seat: Rigid PU foam and full upholstery with a steel reinforcement structure inside. Legs and armrests: Polished aluminum or black powder coated aluminum with five wheels.  
**Color:** All colors in Kvadrat Reflect, Kvadrat Remix, Kvadrat Canvas, Kvadrat Steelcut Trio, Kvadrat Hallingdal, Kvadrat Divina, Kvadrat Divina MD, Kvadrat Divina Melange, Kvadrat Fiord, Kvadrat Vidar and Sørensen Ultra Leather.  
**Production time:** 5 weeks

	605613 Ultra Leather
	607611 Remix
	607612 Canvas
	607613 Steelcut Trio
	607614 Hallingdal
	607615 Divina
	607616 Divina MD
	607617 Divina Melange
	607618 Fiord
	607619 Vidar

# OFF ARMCHAIR HIGH 5W GAS LIFT WITH CUSHION

Design: Simon Legald, 2022

Duty Code: 9401390000

Made in: Lithuania

Construction: Off Chair consists of a seat made from rigid PU foam with full upholstery. Inside the upholstery and PU foam, the chair has a steel reinforcement structure. The base comes with either four static legs or five wheels with swivel and a tilt inclination of 10°, and is made of polished or black powder-coated aluminum. An optional cushion made of veneer and PU foam is available.

Maintenance: Textile: Clean with textile or upholstery cleaner. Leather: Clean with damp cloth. Use warm water with soap flakes. Frequent vacuuming with a soft fitting is recommended for both textile and leather to preserve color and appearance.

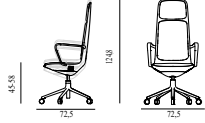

## Off Armchair High 5W Gas Lift Alu With Cushion

Colli: 1

Size & Weight: H: 124,8 x W: 72,5 x D: 72,5 x SH: 45 cm - 16,5 kg

Packing: Brown Box - H: 134 x L: 69 x D: 72 cm - 17,5 kg

M3: 0,6657

Material: Seat: Rigid PU foam and full upholstery with a steel reinforcement structure inside. Legs and armrests: Polished aluminum or black powder coated aluminum with five wheels. Cushion: Veneer and PU foam.

Color: All colors in Kvadrat Reflect, Kvadrat Remix, Kvadrat Canvas, Kvadrat Steelcut Trio, Kvadrat Hallingdal, Kvadrat Divina, Kvadrat Divina MD, Kvadrat Divina Melange, Kvadrat Fiord, Kvadrat Vidar and Sørensen Ultra Leather.

Production time: 5 weeks

	605662 Ultra Leather
	607681 Remix
	607682 Canvas
	607683 Steelcut Trio
	607684 Hallingdal
	607685 Divina
	607686 Divina MD
	607687 Divina Melange
	607688 Fiord
	607689 Vidar

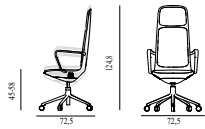

### Off Armchair High 5W Gas Lift Black Alu With Cushion

Colli: 1  
 Size & Weight: H: 124,8 x W: 72,5 x D: 72,5 cm - 16,5 kg  
 Packing: Brown Box - H: 134 x L: 69 x D: 72 cm - 17,5 kg  
 M3: 0,6657  
 Material: Seat: Rigid PU foam and full upholstery with a steel reinforcement structure inside. Legs and armrests: Polished aluminum or black powder coated aluminum with five wheels. Cushion: Veneer and PU foam.  
 Color: All colors in Kvadrat Reflect, Kvadrat Remix, Kvadrat Canvas, Kvadrat Steelcut Trio, Kvadrat Hallingdal, Kvadrat Divina, Kvadrat Divina MD, Kvadrat Divina Melange, Kvadrat Fiord, Kvadrat Vidar and Sørensen Ultra Leather.  
 Production time: 5 weeks

	605669 Ultra Leather
	607691 Remix
	607692 Canvas
	607693 Steelcut Trio
	607694 Hallingdal
	607695 Divina
	607696 Divina MD
	607697 Divina Melange
	607698 Fiord
	607699 Vidar

## ONE STEP UP

Design: Francis Cayouette, 2010  
 Duty Code: 9403208000  
 Made in: China

Construction: One Step Up comes flat packed. Easy to assemble. Just fold out the ladder-like frame and put the shelves in place. The high version comes in 2 boxes - one for the frame and one for the shelves. The frame weighs 16,4 kg without box and 17,4 kg with box. The shelves weigh 18 kg without box and 19 kg with box. The low version is packed in one box. Load capacity: ca. 15 kg pr. shelf.

Maintenance: Clean with damp cloth.

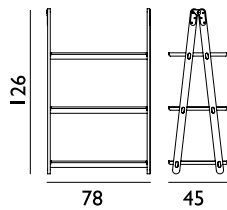

### One Step Up Bookcase Low

Colli: 1  
 Size & Weight: H: 126 x L: 78 x D: 45 cm - 21 kg  
 Packing: Brown Box - H: 149 x L: 88 x D: 18 cm - 22 kg  
 M3: 0,236  
 Material: Powder Coated Steel, Lacquered Ash

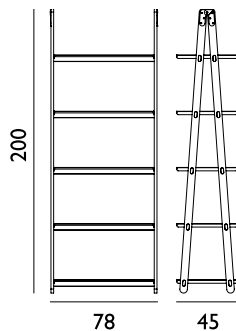

### One Step Up Bookcase High

Colli: 1  
 Size & Weight: H: 200 x L: 78 x D: 45 cm - 35 kg  
 Packing: Brown Box - H: 215 x L: 88 x D: 18 cm - 36 kg  
 Material: Powder Coated Steel, Lacquered Ash



# OONA

Design: Simon Legald, 2013  
 Duty Code: 5701909010  
 Made in: India  
 Construction: The Oona rugs are handmade. The contrasting line is made of a 3 mm shorter pile than the rest of the rug.  
 Maintenance: Dry clean or use textile or upholstery cleaner.

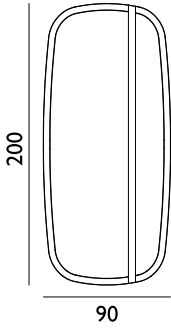
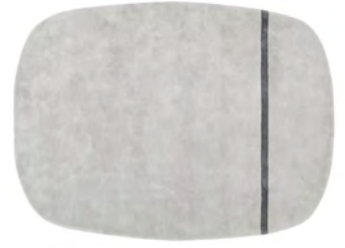

## Oona Rug 90x200

Colli: 1  
 Size & Weight: W: 90 x L: 200 cm - 8,5 kg  
 Packing: Strap Bag - L: 95 x Ø: 22 cm - 8,7 kg  
 Colli Box: L: 95 x cm - 8,7 kg  
 Material: 100 % New Zealand Wool

 602440 Grey	 602443 Mint	 602446 Rose	 602536 Blue
			 602539 Sand

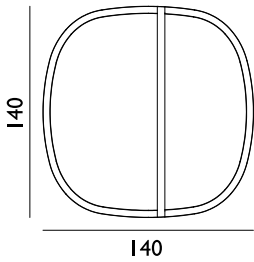

## Oona Rug 140x140

Colli: 1  
 Size & Weight: W: 145 x L: 140 cm - 8,9 kg  
 Packing: Strap Bag - L: 145 x Ø: 19 cm - 9,1 kg  
 Colli Box: L: 145 x cm - 9,1 kg  
 Material: 100 % New Zealand Wool

 602441 Grey	 602444 Mint	 602447 Rose	 602537 Blue
			 602540 Sand

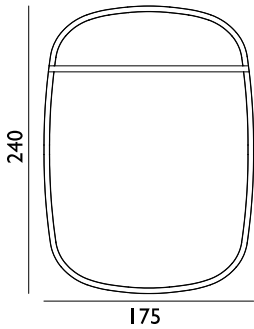

## Oona Rug 175x240

Colli: 1  
 Size & Weight: W: 175 x L: 240 cm - 18,1 kg  
 Packing: Strap Bag - L: 180 x Ø: 25 cm - 18,3 kg  
 Colli Box: L: 180 x cm - 18,3 kg  
 Material: 100 % New Zealand Wool

 602442 Grey	 602445 Mint	 602448 Rose	 602538 Blue
			 602541 Sand

# PAD LOUNGE CHAIR LOW

Design: Simon Legald, 2018

Duty Code: 9401710000

Made in: Lithuania

Construction: Pad is made in molded oak veneer or painted and lacquered ash veneer with molded PU foam. Inside it has a steel reinforcement structure for flexibility and the highest possible sitting comfort. Textile or leather front upholstery. Legs are made of powder coated steel tubes. Delivered assembled.

Maintenance: Textile: Clean with textile or upholstery cleaner. Leather: Clean with damp cloth. Use warm water with soap flakes. Frequent vacuuming with a soft fitting is recommended for both textile and leather to preserve color and appearance.

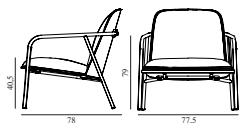

## Pad Lounge Chair Low Black Steel

Colli: 1  
 Size & Weight: H: 79 x W: 77,5 x D: 78 x SH: 40,5 cm - 19,8 kg  
 Packing: Brown Box - H: 92 x L: 91,5 x D: 88 cm - 26 kg  
 Material: Shell: Lacquered Oak Veneer or Painted and Lacquered Ash Veneer, PU Foam and Front Upholstery, Legs: Powder Coated Steel  
 Production time: 6-8 weeks

 601801  
Oak /  
Main Line Flax

 601802  
Oak /  
Synergy

 601803  
Oak /  
Ultra Leather

 601804  
Black /  
Main Line Flax

 601805  
Black /  
Synergy

 601806  
Black /  
Ultra Leather

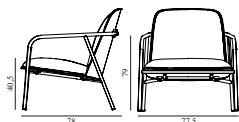

## Pad Lounge Chair Low Grey Steel

Colli: 1  
 Size & Weight: H: 79 x W: 77,5 x D: 78 x SH: 40,5 cm - 19,8 kg  
 Packing: Brown Box - H: 92 x L: 91,5 x D: 88 cm - 26 kg  
 Material: Shell: Lacquered Oak Veneer or Painted and Lacquered Ash Veneer, PU Foam and Front Upholstery, Legs: Powder Coated Steel  
 Production time: 6-8 weeks

 601807  
Oak /  
Main Line Flax

 601808  
Oak /  
Synergy

 601809  
Oak /  
Ultra Leather

 601810  
Black /  
Main Line Flax

 601811  
Black /  
Synergy

 601812  
Black /  
Ultra Leather

# PAD LOUNGE CHAIR HIGH

Design: Simon Legald, 2018

Duty Code: 9401710000

Made in: Lithuania

Construction: Pad is made in molded oak veneer or painted and lacquered ash veneer with molded PU foam. Inside it has a steel reinforcement structure for flexibility and the highest possible sitting comfort. Textile or leather front upholstery. Legs are made of powder coated steel tubes. Delivered assembled.

Maintenance: Textile: Clean with textile or upholstery cleaner. Leather: Clean with damp cloth. Use warm water with soap flakes. Frequent vacuuming with a soft fitting is recommended for both textile and leather to preserve color and appearance.

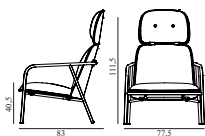

## Pad Lounge Chair High Black Steel

Colli: 1  
 Size & Weight: H: 111,5 x W: 77,5 x D: 83 x SH: 40,5 cm - 23,8 kg  
 Packing: Brown Box - H: 115 x L: 92 x D: 88 cm - 30,2 kg  
 Material: Shell: Lacquered Oak Veneer or Painted and Lacquered Ash Veneer, PU Foam and Front Upholstery, Legs: Powder Coated Steel  
 Production time: 6-8 weeks

 601813  
Oak /  
Main Line Flax

 601814  
Oak /  
Synergy

 601815  
Oak /  
Ultra Leather

 601816  
Black /  
Main Line Flax

 601817  
Black /  
Synergy

 601818  
Black /  
Ultra Leather

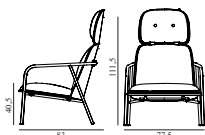

## Pad Lounge Chair High Grey Steel

Colli: 1  
 Size & Weight: H: 111,5 x W: 77,5 x D: 83 x SH: 40,5 cm - 23,8 kg  
 Packing: Brown Box - H: 115 x L: 92 x D: 88 cm - 30,2 kg  
 Material: Shell: Lacquered Oak Veneer or Painted and Lacquered Ash Veneer, PU Foam and Front Upholstery, Legs: Powder Coated Steel  
 Production time: 6-8 weeks

 601819  
Oak /  
Main Line Flax

 601820  
Oak /  
Synergy

 601821  
Oak /  
Ultra Leather

 601822  
Black /  
Main Line Flax

 601823  
Black /  
Synergy

 601824  
Black /  
Ultra Leather

# PAD LOUNGE CHAIR LOW SWIVEL

Design: Simon Legald, 2021

Duty Code: 9401710000

Made in: Lithuania

Construction: Pad Chair Swivel consists of a shell made of lacquered oak veneer or painted ash veneer with molded PU foam and front upholstery. Inside the upholstery and PU foam, the chair has a steel reinforcement structure. The swivel base is made of polished or black powder coated aluminum. Tilt function with inclination from 6.5° to 16.5°. Pad is delivered assembled.

Maintenance: Textile: Clean with textile or upholstery cleaner. Leather: Clean with damp cloth. Use warm water with soap flakes. Frequent vacuuming with a soft fitting is recommended for both textile and leather to preserve color and appearance.



## Pad Lounge Chair Low Swivel Black Alu

Colli: 1  
 Size & Weight: H: 83,2 x W: 82,6 x D: 82,6 x SH: 43,5 cm - 26 kg  
 Packing: Brown Box - H: 85 x L: 85 x D: 85 cm - 29,2 kg  
 M3: 0,6141  
 Material: Shell: lacquered oak veneer or painted ash veneer, PU foam and front upholstery. Legs: Powder Coated Aluminum.  
 Production time: 6 weeks

	605400 Oak / Main Line Flax
	605401 Oak / Synergy
	605402 Oak / Ultra Leather
	605403 Oak / Aquarius
	605404 Oak / Oceanic
	605405 Oak / Yoredale
	605407 Black Oak / Main Line Flax
	605408 Black Oak / Synergy
	605409 Black Oak / Ultra Leather
	605410 Black Oak / Aquarius
	605411 Black Oak / Oceanic
	605412 Black Oak / Yoredale

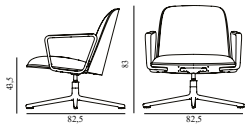

### Pad Lounge Chair Low Swivel Alu

Colli: 1  
 Size & Weight: H: 83,2 x W: 82,6 x D: 82,6 x SH: 43,5 cm - 26 kg  
 Packing: Brown Box - H: 85 x L: 85 x D: 85 cm - 29,2 kg  
 M3: 0,6141  
 Material: Shell: lacquered oak veneer or painted ash veneer, PU foam and front upholstery. Legs: polished aluminum.  
 Production time: 6 weeks

	605414 Oak / Main Line Flax
	605415 Oak / Synergy
	605416 Oak / Ultra Leather
	605417 Oak / Aquarius
	605418 Oak / Oceanic
	605419 Oak / Yoredale
	605421 Black Oak / Main Line Flax
	605422 Black Oak / Synergy
	605423 Black Oak / Ultra Leather
	605424 Black Oak / Aquarius
	605425 Black Oak / Oceanic
	605426 Black Oak / Yoredale



# PAD LOUNGE CHAIR LOW SWIVEL TILT

Design: Simon Legald, 2021









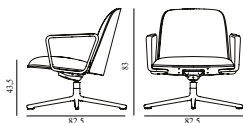



Duty Code: 9401710000

Made in: Lithuania

Construction: Pad Chair Swivel consists of a shell made of lacquered oak veneer or painted ash veneer with molded PU foam and front upholstery. Inside the upholstery and PU foam, the chair has a steel reinforcement structure. The swivel base is made of polished or black powder coated aluminum. Tilt function with inclination from 6.5° to 16.5°. Pad is delivered assembled.

Maintenance: Textile: Clean with textile or upholstery cleaner. Leather: Clean with damp cloth. Use warm water with soap flakes. Frequent vacuuming with a soft fitting is recommended for both textile and leather to preserve color and appearance.



<b>Pad Lounge Chair Low Swivel Alu Tilt</b>	
Colli:	1
Size & Weight:	H: 83,2 x W: 82,6 x D: 82,6 x SH: 43,5 cm - 26 kg
Packing:	Brown Box - H: 85 x L: 85 x D: 85 cm - 29,2 kg
M3:	0,6141
Material:	Shell: lacquered oak veneer or painted ash veneer, PU foam and front upholstery. Legs: polished aluminum.
Production time: 6 weeks	
	605442 Oak / Main Line Flax
	605443 Oak / Synergy
	605444 Oak / Ultra Leather
	605445 Oak / Aquarius
	605446 Oak / Oceanic
	605447 Oak / Yoredale
	605449 Black Oak / Main Line Flax
	605450 Black Oak / Synergy
	605451 Black Oak / Ultra Leather
	605452 Black Oak / Aquarius
	605453 Black Oak / Oceanic
	605454 Black Oak / Yoredale



### Pad Lounge Chair Low Swivel Black Alu Tilt

Colli: 1  
 Size & Weight: H: 83,2 x W: 82,6 x D: 82,6 x SH: 43,5 cm - 26 kg  
 Packing: Brown Box - H: 85 x L: 85 x D: 85 cm - 29,2 kg  
 M3: 0,6141  
 Material: Shell: lacquered oak veneer or painted ash veneer, PU foam and front upholstery. Legs: Powder Coated Aluminum.  
 Production time: 6 weeks

	605428 Oak / Main Line Flax
	605429 Oak / Synergy
	605430 Oak / Ultra Leather
	605431 Oak / Aquarius
	605432 Oak / Oceanic
	605433 Oak / Yoredale
	605435 Black Oak / Main Line Flax
	605436 Black Oak / Synergy
	605437 Black Oak / Ultra Leather
	605438 Black Oak / Aquarius
	605439 Black Oak / Oceanic
	605440 Black Oak / Yoredale

# PAD LOUNGE CHAIR HIGH SWIVEL

Design: Simon Legald, 2021

Duty Code: 9401710000

Made in: Lithuania

Construction: Pad Chair Swivel consists of a shell made of lacquered oak veneer or painted ash veneer with molded PU foam and front upholstery. Inside the upholstery and PU foam, the chair has a steel reinforcement structure. The swivel base is made of polished or black powder coated aluminum. Tilt function with inclination from 6.5° to 16.5°. Pad is delivered assembled.

Maintenance: Textile: Clean with textile or upholstery cleaner. Leather: Clean with damp cloth. Use warm water with soap flakes. Frequent vacuuming with a soft fitting is recommended for both textile and leather to preserve color and appearance.

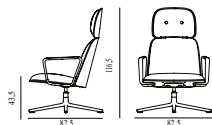

## Pad Lounge Chair High Swivel Alu

Colli: 1  
 Size & Weight: H: 116,4 x W: 82,6 x D: 82,6 x SH: 43,5 cm - 28,2 kg  
 Packing: Brown Box - H: 120 x L: 85 x D: 85 cm - 31,7 kg  
 M3: 0,867  
 Material: Shell: lacquered oak veneer or painted ash veneer, PU foam and front upholstery. Legs: polished aluminum.  
 Production time: 6 weeks

	605470 Oak / Main Line Flax
	605471 Oak / Synergy
	605472 Oak / Ultra Leather
	605473 Oak / Aquarius
	605474 Oak / Oceanic
	605475 Oak / Yoredale
	605477 Black Oak / Main Line Flax
	605478 Black Oak / Synergy
	605479 Black Oak / Ultra Leather
	605480 Black Oak / Aquarius
	605481 Black Oak / Oceanic
	605482 Black Oak / Yoredale

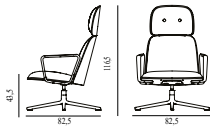

**Pad Lounge Chair High Swivel Black Alu**

Colli: 1  
 Size & Weight: H: 116,4 x W: 82,6 x D: 82,6 x SH: 43,5 cm - 28,2 kg  
 Packing: Brown Box - H: 120 x L: 85 x D: 85 cm - 31,7 kg  
 M3: 0,867  
 Material: Shell: lacquered oak veneer or painted ash veneer, PU foam and front upholstery. Legs: Powder Coated Aluminum.  
 Production time: 6 weeks

	605456 Oak / Main Line Flax
	605457 Oak / Synergy
	605458 Oak / Ultra Leather
	605459 Oak / Aquarius
	605460 Oak / Oceanic
	605461 Oak / Yoredale
	605463 Black Oak / Main Line Flax
	605464 Black Oak / Synergy
	605465 Black Oak / Ultra Leather
	605466 Black Oak / Aquarius
	605467 Black Oak / Oceanic
	605468 Black Oak / Yoredale

# PAD LOUNGE CHAIR HIGH SWIVEL TILT

Design: Simon Legald, 2021

Duty Code: 9401710000

Made in: Lithuania

Construction: Pad Chair Swivel consists of a shell made of lacquered oak veneer or painted ash veneer with molded PU foam and front upholstery. Inside the upholstery and PU foam, the chair has a steel reinforcement structure. The swivel base is made of polished or black powder coated aluminum. Tilt function with inclination from 6.5° to 16.5°. Pad is delivered assembled.

Maintenance: Textile: Clean with textile or upholstery cleaner. Leather: Clean with damp cloth. Use warm water with soap flakes. Frequent vacuuming with a soft fitting is recommended for both textile and leather to preserve color and appearance.

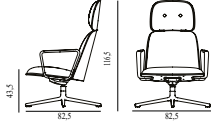

## Pad Lounge Chair High Swivel Black Alu Tilt

Colli: 1  
 Size & Weight: H: 116,4 x W: 82,6 x D: 82,6 x SH: 43,5 cm - 28,2 kg  
 Packing: Brown Box - H: 120 x L: 85 x D: 85 cm - 31,7 kg  
 M3: 0,867  
 Material: Shell: lacquered oak veneer or painted ash veneer, PU foam and front upholstery. Legs: black powder coated aluminum.  
 Production time: 6 weeks

	605484 Oak / Main Line Flax
	605485 Oak / Synergy
	605486 Oak / Ultra Leather
	605487 Oak / Aquarius
	605488 Oak / Oceanic
	605489 Oak / Yoredale
	605491 Black Oak / Main Line Flax
	605492 Black Oak / Synergy
	605493 Black Oak / Ultra Leather
	605494 Black Oak / Aquarius
	605495 Black Oak / Oceanic
	605496 Black Oak / Yoredale

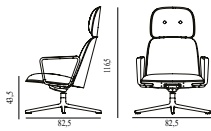

### Pad Lounge Chair High Swivel Alu Tilt

Colli: 1  
 Size & Weight: H: 116,4 x W: 82,6 x D: 82,6 x SH: 43,5 cm - 28,2 kg  
 Packing: Brown Box - H: 120 x L: 85 x D: 85 cm - 31,7 kg  
 M3: 0,867  
 Material: Shell: lacquered oak veneer or painted ash veneer, PU foam and front upholstery. Legs: polished aluminum.  
 Production time: 6 weeks

	605498 Oak / Main Line Flax
	605499 Oak / Synergy
	605500 Oak / Ultra Leather
	605501 Oak / Aquarius
	605502 Oak / Oceanic
	605503 Oak / Yoredale
	605505 Black Oak / Main Line Flax
	605506 Black Oak / Synergy
	605507 Black Oak / Ultra Leather
	605508 Black Oak / Aquarius
	605509 Black Oak / Oceanic
	605510 Black Oak / Yoredale

# PAD FOOTSTOOL

Design: Simon Legald, 2018

Duty Code: 9403208000

Made in: Lithuania

Construction: Pad is made in molded oak veneer or painted and lacquered ash veneer with molded PU foam. Inside it has a steel reinforcement structure for flexibility and the highest possible sitting comfort. Textile or leather front upholstery. Legs are made of powder coated steel tubes. Delivered assembled.

Maintenance: Textile: Clean with textile or upholstery cleaner. Leather: Clean with damp cloth. Use warm water with soap flakes. Frequent vacuuming with a soft fitting is recommended for both textile and leather to preserve color and appearance.

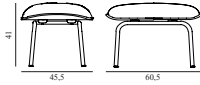

## Pad Footstool Black Steel





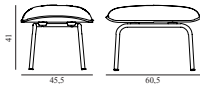

Colli: 1  
 Size & Weight: H: 41 x W: 60,5 x D: 45,5 cm - 6 kg  
 Packing: Brown Box - H: 43,5 x L: 64 x D: 51,5 cm - 7,6 kg  
 Material: Shell: Lacquered Oak Veneer or Painted and Lacquered Ash Veneer, PU Foam and Front Upholstery, Legs: Powder Coated Steel  
 Production time: 6-8 weeks

	601849 Oak / Main Line Flax
	601850 Oak / Synergy
	601851 Oak / Ultra Leather
	601852 Black / Main Line Flax
	601853 Black / Synergy
	601854 Black / Ultra Leather



## Pad Footstool Grey Steel

Colli: 1  
 Size & Weight: H: 41 x W: 60,5 x D: 45,5 cm - 6 kg  
 Packing: Brown Box - H: 43,5 x L: 64 x D: 51,5 cm - 7,6 kg  
 Material: Shell: Lacquered Oak Veneer or Painted and Lacquered Ash Veneer, PU Foam and Front Upholstery, Legs: Powder Coated Steel  
 Production time: 6-8 weeks

	601855 Oak / Main Line Flax
	601856 Oak / Synergy
	601857 Oak / Ultra Leather
	601858 Black / Main Line Flax
	601859 Black / Synergy
	601860 Black / Ultra Leather

# PAD GLIDES

Duty Code: 9401999090

Construction: Different types of flooring require different types of glides.

Maintenance: We recommend to check the glides every 3-6 months. If worn down, please replace.

## Pad Footstool Glides

 900119  
PE for steel w. felt /  
Black /  
4pcs

## Pad Lounge Chair Glides

 900120  
PE for steel w. felt  
front /  
Black /  
2pcs

 900121  
PE for steel w. felt  
back /  
Black /  
2pcs

# PINE

Design: Simon Legald, 2018

Duty Code: 9403601000

Made in: Lithuania

Construction: Made of solid pine planks. The table is delivered assembled.

Maintenance: Clean with damp cloth.

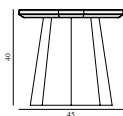

## Pine Table Small

Colli: 1  
Size & Weight: H: 40,6 x Ø: 45 cm - 8 kg  
Packing: Brown Box - H: 45 x L: 48 x D: 48 cm - 10,6 kg  
Material: Stained Lacquered Pine



602543  
Pine



602544  
Dark Blue



602545  
Dark Grey



607985  
Rose



607986  
Light Green

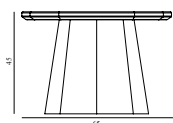

## Pine Table Large

Colli: 1  
Size & Weight: H: 44,6 x Ø: 65 cm - 13 kg  
Packing: Brown Box - H: 50 x L: 69 x D: 69 cm - 18,8 kg  
Material: Stained Lacquered Pine



602547  
Pine



602548  
Dark Blue



602549  
Dark Grey



607987  
Rose

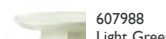

607988  
Light Green



# POLLI RUG

Design: Simon Legald, 2021  
 Duty Code: 5701909010  
 Made in: India  
 Construction: The Polli rug is woven from recycled polyester, Polyethylene Terephthalate (rPET), made from post-consumer plastic bottles.  
 Maintenance: Carefully clean with a damp cloth and mild detergent.

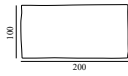

## Polli Rug 100x200 cm

Colli: 1  
 Size & Weight: W: 100 x L: 200 cm - 6 kg  
 Packing: Rolled and packed in clear poly bag  
 Material: Recycled Polyethylene Terephthalate (rPET)

 603670 Sand	 603671 Dark Grey	 603672 Sand multi	 603673 Grey multi
--------------------------------------------------------------------------------------------------	-------------------------------------------------------------------------------------------------------	----------------------------------------------------------------------------------------------------------	----------------------------------------------------------------------------------------------------------

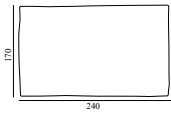

## Polli Rug 170x240 cm

Colli: 1  
 Size & Weight: W: 170 x L: 240 cm - 11 kg  
 Packing: Rolled and packed in clear poly bag  
 Material: Recycled Polyethylene Terephthalate (rPET)

 603674 Sand	 603675 Dark Grey	 603676 Sand multi	 603677 Grey multi
--------------------------------------------------------------------------------------------------	-------------------------------------------------------------------------------------------------------	----------------------------------------------------------------------------------------------------------	----------------------------------------------------------------------------------------------------------

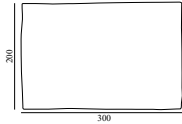

## Polli Rug 200x300 cm

Colli: 1  
 Size & Weight: W: 200 x L: 300 cm - 16 kg  
 Packing: Rolled and packed in clear poly bag  
 Material: Recycled Polyethylene Terephthalate (rPET)

 603678 Sand	 603679 Dark Grey	 603680 Sand multi	 603681 Grey multi
----------------------------------------------------------------------------------------------------	---------------------------------------------------------------------------------------------------------	------------------------------------------------------------------------------------------------------------	------------------------------------------------------------------------------------------------------------

# RIB

Design: Simon Legald, 2022  
 Duty Code: 9403208000  
 Made in: Turkey  
 Construction: Rib is designed in lacquered oak veneer or painted and lacquered oak veneer with solid oak slats and base. Rib is equipped with a push latch, making handles redundant, and has removable shelves that can be adjusted in height, giving the possibility to store any object or belongings. Rib is delivered assembled.  
 Maintenance: Clean with a damp cloth.

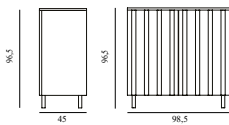

## Rib Cabinet

Colli: 1  
 Size & Weight: H: 96,5 x W: 45 x L: 98,5 cm - 39 kg  
 Packing: Brown Box - H: 90 x L: 103 x D: 51 cm - 47 kg  
 Material: Lacquered oak veneer or painted and lacquered oak veneer  
 Color: Oak or Soft Black

 607750 Oak	 607751 Soft Black
---------------------------------------------------------------------------------------------------	----------------------------------------------------------------------------------------------------------

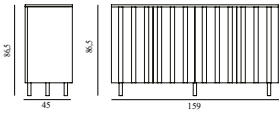

### Rib Sideboard

Colli: 1  
 Size & Weight: H: 86,5 x W: 45 x L: 159 cm - 57 kg  
 Packing: Brown Box - H: 80 x L: 164 x D: 51 cm  
 Material: Lacquered oak veneer or painted and lacquered oak veneer  
 Color: Oak or Soft Black

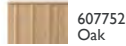

607752  
Oak



607753  
Soft Black

## ROPE

Design: Hans Hornemann, 2016  
 Duty Code: 9401610000  
 Made in: Poland

Construction: Rope Sofa consists of a wooden frame with pocket springs. The frame is covered in durable furniture foam all over, ensuring optimal sitting comfort. The sofa features piping on all edges. The legs are made of black lacquered wood and measure approx. 1,5 cm in height.

Maintenance: Textile: Clean with textile or upholstery cleaner. Leather: Clean with a damp cloth. Use warm water with soap flakes. Frequent vacuuming with a soft fitting is recommended for both textile and leather to preserve color and appearance.

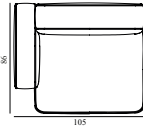

### Rope Modular Sofa 100 Narrow Left Armrest

Colli: 1  
 Size & Weight: H: 67 x W: 105 x D: 86 x SH: 39 cm - 35 kg  
 Packing: Brown Box - H: 75 x L: 110 x D: 93 cm - 42 kg  
 Material: HR Foam, Pocket Springs and Upholstery Legs: Painted and Lacquered Ash.

Production time: 6 weeks

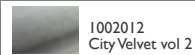

1002012  
City Velvet vol 2

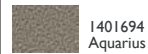

1401694  
Aquarius



1401695  
Oceanic

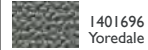

1401696  
Yoredale



603600  
Main Line flax



603601  
Synergy



900301  
Optimo

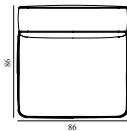

### Rope Modular Sofa 110 Narrow Center

Colli: 1  
 Size & Weight: H: 67 x W: 86 x D: 86 x SH: 39 cm - 27 kg  
 Packing: Brown Box - H: 76 x L: 110 x D: 92,5 cm - 34 kg  
 Material: HR Foam, Pocket Springs and Upholstery Legs: Painted and Lacquered Ash.

Production time: 6 weeks

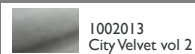

1002013  
City Velvet vol 2



1401698  
Aquarius



1401699  
Oceanic



1401700  
Yoredale



603602  
Main Line flax



603603  
Synergy



900302  
Optimo

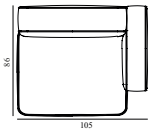

### Rope Modular Sofa 120 Narrow Right Armrest

Colli: 1  
 Size & Weight: H: 67 x W: 105 x D: 86 x SH: 39 cm - 35 kg  
 Packing: Brown Box - H: 76 x L: 110 x D: 92,5 cm - 42 kg  
 Material: HR Foam, Pocket Springs and Upholstery Legs: Painted and Lacquered Ash.  
 Production time: 6 weeks

	1002014 City Velvet vol 2
	1401702 Aquarius
	1401703 Oceanic
	1401704 Yoredale
	603604 Main Line flax
	603605 Synergy
	900303 Optimo

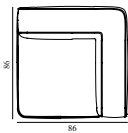

### Rope Modular Sofa 150 Narrow Corner

Colli: 1  
 Size & Weight: H: 67 x W: 86 x D: 86 x SH: 39 cm - 35 kg  
 Packing: Brown Box - H: 76 x L: 110 x D: 92,5 cm - 42 kg  
 M3: 0,7631  
 Material: HR Foam, Pocket Springs and Upholstery Legs: Painted and Lacquered Ash.  
 Production time: 6 weeks

	1002015 City Velvet vol 2
	1401706 Aquarius
	1401707 Oceanic
	1401708 Yoredale
	603606 Main Line flax
	603607 Synergy
	900304 Optimo

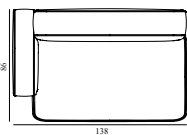

### Rope Modular Sofa 300 Wide Left Armrest

Colli: 1  
 Size & Weight: H: 67 x W: 138 x D: 86 x SH: 39 cm - 35 kg  
 Packing: Brown Box - H: 75,5 x L: 145 x D: 92 cm - 43 kg  
 Material: HR Foam, Pocket Springs and Upholstery Legs: Painted and Lacquered Ash.  
 Production time: 6 weeks

	1002016 City Velvet vol 2
	1401710 Aquarius
	1401711 Oceanic
	1401712 Yoredale
	603608 Main Line flax
	603609 Synergy
	900305 Optimo

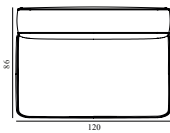

### Rope Modular Sofa 310 Wide Center

Colli: 1  
 Size & Weight: H: 67 x W: 120 x D: 86 x SH: 39 cm - 35 kg  
 Material: HR Foam, Pocket Springs and Upholstery Legs: Painted and Lacquered Ash.  
 Production time: 6 weeks

	1002017 City Velvet vol 2
	1401714 Aquarius
	1401715 Oceanic
	1401716 Yoredale
	603610 Main Line flax
	603611 Synergy
	900306 Optimo

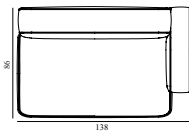

### Rope Modular Sofa 320 Wide Right Armrest

Colli: 1  
 Size & Weight: H: 67 x W: 138 x D: 86 x SH: 39 cm - 35 kg  
 Packing: Brown Box - H: 75,5 x L: 145 x D: 92 cm - 43 kg  
 Material: HR Foam, Pocket Springs and Upholstery Legs: Painted and Lacquered Ash.  
 Production time: 6 weeks

	1002018 City Velvet vol 2
	1401718 Aquarius
	1401719 Oceanic
	1401720 Yoredale
	603612 Main Line flax
	603613 Synergy
	900307 Optimo

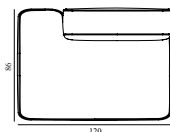

### Rope Modular Sofa 330 Wide Open Left side

Colli: 1  
 Size & Weight: H: 67 x W: 120 x D: 86 x SH: 39 cm - 35 kg  
 Packing: Brown Box - H: 75,5 x L: 145 x D: 92 cm - 43 kg  
 Material: HR Foam, Pocket Springs and Upholstery Legs: Painted and Lacquered Ash.  
 Production time: 6 weeks

	1002019 City Velvet vol 2
	1401722 Aquarius
	1401723 Oceanic
	1401724 Yoredale
	603614 Main Line flax
	603615 Synergy
	900308 Optimo

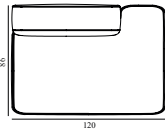

**Rope Modular Sofa 340 Wide Open Right side**

Colli: 1  
 Size & Weight: H: 67 x W: 120 x D: 86 x SH: 39 cm - 35 kg  
 Packing: Brown Box - H: 75,5 x L: 145 x D: 92 cm - 43 kg  
 M3: 1,0072  
 Material: HR Foam, Pocket Springs and Upholstery Legs: Painted and Lacquered Ash.  
 Production time: 6 weeks

	1002020 City Velvet vol 2
	1401726 Aquarius
	1401727 Oceanic
	1401728 Yoredale
	603616 Main Line flax
	603617 Synergy
	900309 Optimo

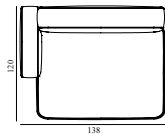

**Rope Modular Sofa 400 Wide Chaise Longue Left Armrest**

Size & Weight: H: 67 x W: 138 x D: 120 x SH: 39 cm - 48,2 kg  
 Packing: Brown Box - H: 75 x L: 144 x D: 127 cm - 57,6 kg  
 Material: HR Foam, Pocket Springs and Upholstery Legs: Painted and Lacquered Ash.  
 Production time: 6 weeks

	1002021 City Velvet vol 2
	1401730 Aquarius
	1401731 Oceanic
	1401732 Yoredale
	603618 Main Line flax
	603619 Synergy
	900310 Optimo

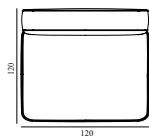

**Rope Modular Sofa 410 Wide Chaise Longue Center**

Size & Weight: H: 67 x W: 120 x D: 120 x SH: 39 cm - 48,2 kg  
 Material: HR Foam, Pocket Springs and Upholstery Legs: Painted and Lacquered Ash.  
 Production time: 6 weeks

	1002022 City Velvet vol 2
	1401734 Aquarius
	1401735 Oceanic
	1401736 Yoredale
	603620 Main Line flax
	603621 Synergy
	900311 Optimo

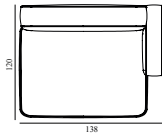

### Rope Modular Sofa 420 Wide Chaise Longue Right Armrest

Size & Weight: H: 67 x W: 138 x D: 120 x SH: 39 cm - 48,2 kg  
 Material: HR Foam, Pocket Springs and Upholstery Legs: Painted and Lacquered Ash.

Production time: 6 weeks

	1002023 City Velvet vol 2
	1401738 Aquarius
	1401739 Oceanic
	1401740 Yoredale
	603622 Main Line flax
	603623 Synergy
	900312 Optimo

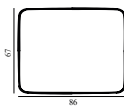

### Rope Modular Sofa 700 Pouf Small

Coll: I  
 Size & Weight: H: 39 x W: 86 x D: 67 cm - 17,4 kg  
 Packing: Brown Box - H: 45 x L: 92 x D: 74 cm - 20,4 kg  
 Material: HR Foam, Pocket Springs and Upholstery Legs: Painted and Lacquered Ash.

Production time: 6 weeks

	1002024 City Velvet vol 2
	1401742 Aquarius
	1401743 Oceanic
	1401744 Yoredale
	603624 Main Line flax
	603625 Synergy
	900313 Optimo

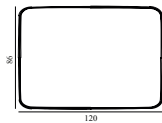

### Rope Modular Sofa 710 Pouf Large

Coll: I  
 Size & Weight: H: 39 x W: 120 x D: 86 cm - 27 kg  
 Packing: Brown Box - H: 75,5 x L: 144 x D: 92,5 cm - 31 kg  
 Material: HR Foam, Pocket Springs and Upholstery Legs: Painted and Lacquered Ash.

Production time: 6 weeks

	1002025 City Velvet vol 2
	1401746 Aquarius
	1401747 Oceanic
	1401748 Yoredale
	603626 Main Line flax
	603627 Synergy
	900314 Optimo

**Rope Cushion 800 60x30 cm**

Colli: 1  
 Size & Weight: H: 30 x W: 60 cm  
 Packing: Brown Box  
 Production time: 6 weeks

 1002033  
City Velvet vol 2

 1401750  
Aquarius

 1401751  
Oceanic

 1401752  
Yoredale

 603628  
Main Line flax

 603629  
Synergy

 900315  
Optimo

**Rope Cushion 810 47x43 cm**

Colli: 1  
 Size & Weight: H: 43 x W: 47 cm  
 Packing: Brown Box  
 Production time: 6 weeks

 1002038  
City Velvet vol 2

 1401754  
Aquarius

 1401755  
Oceanic

 1401756  
Yoredale

 603630  
Main Line flax

 603631  
Synergy

 900316  
Optimo

## SCALA CAFÉ TABLE H75

Design: Simon Legald, 2021  
 Duty Code: 6802910010  
 Made in: Denmark

Construction: Scala table consist of a powder coated steel base with four poles. The tabletop comes in various sizes and shapes available in marble, veneer or stainless steel. The table is delivered flat-packed and must be assembled using the included tools. The tabletop is mounted with four screws. The marble tabletops are treated with a surface treatment that penetrates into the material and thereby provides a long-term protection. The surface should not be exposed to acidic foods or beverages, which can leave stains on the surface.

Maintenance: Clean with a damp cloth.

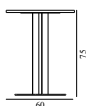
**Scala Café Table H75 Ø60 cm Oak**

Colli: 1  
 Size & Weight: H: 75 x Ø: 60 cm - 23,2 kg  
 Packing: Tabletop: Brown Box - L: 63 x B: 63 x D: 4,5 cm - 5,5 kg - 0,018 m<sup>3</sup> - Base: Brown Box - L: 50 x B: 50 x H: 4 cm - 14 kg - 0,01 m<sup>3</sup> - Pillar: Brown Box - L: 9,5 x B: 9,5 x H: 76 - 8 kg - 0,006 m<sup>3</sup>  
 Material: Base in powder coated steel. Tabletop in oak veneer.  
 Color: Oak, Black oak  
 Production time: 2 weeks

604168  
Oak

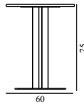

### Scala Café Table H75 Ø60 cm Marble

Colli: 1  
Size & Weight: H: 75 x Ø: 60 cm - 32,3 kg  
Packing:  
Material: Base in powder coated steel. Tabletop in polished marble.  
Color: Black, White, Sand, Coffee  
Production time: 2 weeks

604169  
Marble

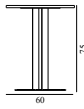

### Scala Café Table H75 Ø60 cm Steel

Colli: 1  
Size & Weight: H: 75 x Ø: 60 cm - 28,3 kg  
Packing:  
Material: Base in powder coated steel. Tabletop in brushed stainless steel.  
Color: Steel  
Production time: 2 weeks

604170  
Steel

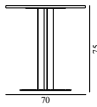

### Scala Café Table H75 Ø70 cm Oak

Colli: 1  
Size & Weight: H: 75 x Ø: 70 cm - 27,7 kg  
Packing: Tabletop: Brown Box - L: 73 x B: 73 x D: 4,5 cm - 8,9 kg - 0,024 m<sup>3</sup> - Base: Brown Box - L: 50 x B: 50 x H: 4 cm - 14 kg - 0,01 m<sup>3</sup> - Pillar: Brown Box - L: 9,5 x B: 9,5 x H: 76 - 8 kg - 0,006 m<sup>3</sup>  
Material: Base in powder coated steel. Tabletop in oak veneer.  
Color: Oak, Black oak  
Production time: 2 weeks

604171  
Oak

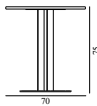

### Scala Café Table H75 Ø70 cm Marble

Colli: 1  
Size & Weight: H: 75 x Ø: 70 cm - 37,9 kg  
Packing:  
Material: Base in powder coated steel. Tabletop in polished marble.  
Color: Black, White, Sand, Coffee  
Production time: 2 weeks

604172  
Marble

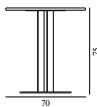

### Scala Café Table H75 Ø70 cm Steel

Colli: 1  
Size & Weight: H: 75 x Ø: 70 cm - 31,4 kg  
Packing:  
Material: Base in powder coated steel. Tabletop in brushed stainless steel.  
Color: Steel  
Production time: 2 weeks

604173  
Steel

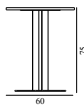

### Scala Café Table H75 60x60 cm Oak

Colli: 1  
Size & Weight: H: 75 x W: 60 x L: 60 cm - 24,2 kg  
Packing: Tabletop: Brown Box - L: 63 x B: 63 x D: 4,5 cm - 6 kg - 0,018 m<sup>3</sup> - Base: Brown Box - L: 50 x B: 50 x H: 4 cm - 14 kg - 0,01 m<sup>3</sup> - Pillar: Brown Box - L: 9,5 x B: 9,5 x H: 76 - 8 kg - 0,006 m<sup>3</sup>  
Material: Base in powder coated steel. Tabletop in oak veneer.  
Color: Oak, Black oak  
Production time: 2 weeks

604174  
Oak

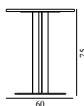

### Scala Café Table H75 60x60 cm Steel

Colli: 1  
Size & Weight: H: 75 x W: 60 x L: 60 cm - 30,9 kg  
Packing:  
Material: Base in powder coated steel. Tabletop in brushed stainless steel.  
Color: Steel  
Production time: 2 weeks

604175  
Steel



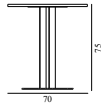

**Scala Café Table H75 70x70 cm Oak**  
Colli: 1  
Size & Weight: H: 75 x W: 70 x L: 70 cm - 26,3 kg  
Packing: Tabletop: Brown Box - L: 73 x B: 73 x D: 4,5 cm - 7,5 kg - 0,024 m<sup>3</sup> - Base: Brown Box - L: 50 x B: 50 x H: 4 cm - 14 kg - 0,01 m<sup>3</sup> - Pillar: Brown Box - L: 9,5 x B: 9,5 x H: 76 - 8 kg - 0,006 m<sup>3</sup>  
Material: Base in powder coated steel. Tabletop in oak veneer.  
Color: Oak, Black oak  
Production time: 2 weeks

604176  
Oak

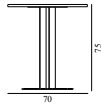

**Scala Café Table H75 70x70 cm Marble**  
Colli: 1  
Size & Weight: H: 75 x W: 70 x L: 70 cm - 47 kg  
Packing: Material: Base in powder coated steel. Tabletop in polished marble.  
Color: Black, White, Sand, Coffee  
Production time: 2 weeks

604177  
Marble

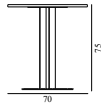

**Scala Café Table H75 70x70 cm Steel**  
Colli: 1  
Size & Weight: H: 75 x W: 70 x L: 70 cm - 35,1 kg  
Packing: Material: Base in powder coated steel. Tabletop in brushed stainless steel.  
Color: Steel  
Production time: 2 weeks

604178  
Steel

## SCALA TABLE H75 CM

Design: Simon Legald, 2021  
Duty Code: 9403890000  
Made in: Denmark

Construction: Scala table consist of a powder coated steel base with four poles. The tabletop comes in various sizes and shapes available in marble, veneer or stainless steel. The table is delivered flat-packed and must be assembled using the included tools. The tabletop is mounted with four screws. The marble tabletops are treated with a surface treatment that penetrates into the material and thereby provides a long-term protection. The surface should not be exposed to acidic foods or beverages, which can leave stains on the surface.

Maintenance: Clean with a damp cloth.

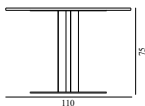

**Scala Table H75 Ø110 cm Oak**  
Colli: 1  
Size & Weight: H: 75 x Ø: 110 cm - 53,4 kg  
Packing: Tabletop: Brown Box - L: 113 x B: 113 x H: 4,5 cm - 18 kg - 0,57 m<sup>3</sup> - Base: Brown Box - L: 71 x B: 71 x H: 4 cm - 34 kg - 0,02 m<sup>3</sup> - Pillar: Brown Box - L: 9,5 x B: 9,5 x H: 76 - 9 kg - 0,006 m<sup>3</sup>  
Material: Base in powder coated steel. Tabletop in oak veneer.  
Color: Oak, Black oak  
Production time: 2 weeks

604179  
Oak

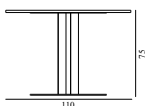

**Scala Table H75 Ø110 cm Marble**  
Colli: 1  
Size & Weight: H: 75 x Ø: 110 cm  
Packing: Material: Base in powder coated steel. Tabletop in polished marble.  
Color: Black, White, Sand, Coffee  
Production time: 2 weeks

604180  
Marble

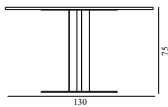

### Scala Table H75 Ø130 cm Oak

Colli: 1  
 Size & Weight: H: 75 x Ø: 130 cm - 59,4 kg  
 Packing: Tabletop: Brown Box - L: 133 x B: 133 x H: 4,5 cm - 24 kg - 0,8 m3 - Base: Brown Box - L: 71 x B: 71 x H: 4 cm - 34 kg - 0,02 m3 - Pillar: Brown Box - L: 9,5 x W: 9,5 x H: 76 - 9 kg - 0,006 m3  
 Material: Base in powder coated steel. Tabletop in oak veneer.  
 Color: Oak, Black oak  
 Production time: 2 weeks

604181  
 Oak

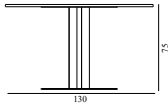

### Scala Table H75 Ø130 cm Marble

Colli: 1  
 Size & Weight: H: 75 x Ø: 130 cm - 63 kg  
 Packing: Base in powder coated steel. Tabletop in polished marble.  
 Material: Base in powder coated steel. Tabletop in polished marble.  
 Color: Black, White, Sand, Coffee  
 Production time: 2 weeks

604182  
 Marble

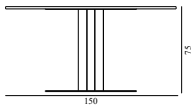

### Scala Table H75 Ø150 cm Oak

Colli: 1  
 Size & Weight: H: 75 x Ø: 150 cm  
 Packing: Brown Box  
 Material: Base in powder coated steel. Tabletop in oak veneer.  
 Color: Oak, Black oak  
 Production time: 2 weeks

604183  
 Oak

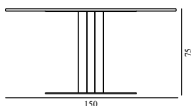

### Scala Table H75 Ø150 cm Marble

Colli: 1  
 Size & Weight: H: 75 x Ø: 150 cm  
 Packing: Base in powder coated steel. Tabletop in polished marble.  
 Material: Base in powder coated steel. Tabletop in polished marble.  
 Color: Black, White, Sand, Coffee  
 Production time: 2 weeks

604184  
 Marble

## SCALA TABLE H40 CM

Design: Simon Legald, 2021

Duty Code: 9403890000

Made in: Denmark

Construction: Scala table consist of a powder coated steel base with four poles. The tabletop comes in various sizes and shapes available in marble, veneer or stainless steel. The table is delivered flat-packed and must be assembled using the included tools. The tabletop is mounted with four screws. The marble tabletops are treated with a surface treatment that penetrates into the material and thereby provides a long-term protection. The surface should not be exposed to acidic foods or beverages, which can leave stains on the surface.

Maintenance: Clean with a damp cloth.

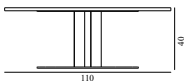

### Scala Coffee Table H40 Ø110 cm Oak

Colli: 1  
 Size & Weight: H: 40 x Ø: 110 cm - 53,4 kg  
 Packing: Tabletop: Brown Box - L: 113 x B: 113 x H: 4,5 cm - 18 kg - 0,57 m3 - Base: Brown Box - L: 71 x B: 71 x H: 4 cm - 34 kg - 0,02 m3 - Pillar: Brown Box - L: 9,5 x B: 9,5 x H: 76 - 5,5 kg - 0,006 m3  
 Material: Base in powder coated steel. Tabletop in oak veneer.  
 Color: Oak, Black oak  
 Production time: 2 weeks

604185  
 Oak

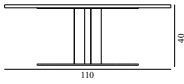

### Scala Coffee Table H40 Ø110 cm Marble

Colli: 1  
Size & Weight: H: 40 x Ø: 110 cm  
Packing:  
Material: Base in powder coated steel. Tabletop in polished marble.  
Color: Black, White, Sand, Coffee  
Production time: 2 weeks

604186  
Marble

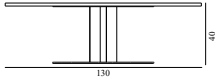

### Scala Coffee Table H40 Ø130 cm Oak

Colli: 1  
Size & Weight: H: 40 x Ø: 130 cm - 59,4 kg  
Packing: Tabletop: Brown Box - L: 133 x B: 133 x H: 4,5 cm - 24 kg - 0,8 m<sup>3</sup> - Base: Brown Box - L: 71 x B: 71 x H: 4 cm - 34 kg - 0,02 m<sup>3</sup> - Pillar: Brown Box - L: 9,5 x B: 9,5 x H: 76 - 5,5 kg - 0,006 m<sup>3</sup>  
Material: Base in powder coated steel. Tabletop in oak veneer.  
Color: Oak, Black oak  
Production time: 2 weeks

604187  
Oak

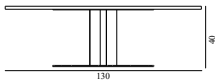

### Scala Coffee Table H40 Ø130 cm Marble

Colli: 1  
Size & Weight: H: 40 x Ø: 130 cm  
Packing:  
Material: Base in powder coated steel. Tabletop in polished marble.  
Color: Black, White, Sand, Coffee  
Production time: 2 weeks

604188  
Marble

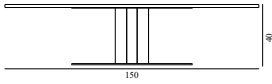

### Scala Coffee Table H40 Ø150 cm Oak

Colli: 1  
Size & Weight: H: 40 x Ø: 150 cm  
Packing:  
Material: Base in powder coated steel. Tabletop in oak veneer.  
Color: Oak, Black oak  
Production time: 2 weeks

604189  
Oak

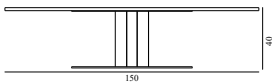

### Scala Coffee Table H40 Ø150 cm Marble

Colli: 1  
Size & Weight: H: 40 x Ø: 150 cm  
Packing:  
Material: Base in powder coated steel. Tabletop in polished marble.  
Color: Black, White, Sand, Coffee  
Production time: 2 weeks

604190  
Marble

# SILO POUF

Design: Hans Hornemann, 2017

Duty Code: 9401610000

Made in: Lithuania

Construction: Silo pouf is made of cut PU foam glued to plywood boards.

The plywood creates stability in the construction while adding a sharp visual profile. The foam creates soft comfort with a firm surface, which opens for more flexible uses e.g. as alternative to a coffee table.

Maintenance: Textile: Clean with textile or upholstery cleaner. Frequent vacuuming with a soft fitting is recommended to preserve color and appearance.



## Silo Pouf Small

Colli: 1  
 Size & Weight: H: 46 x Ø: 50 cm - 7 kg  
 Packing: Brown Box - H: 48 x L: 50,5 x D: 50 cm - 8,2 kg  
 Material: Plywood, PU Foam and Textile  
 Production time: 6 weeks

	601300 Deep Sea / Bolgheri 8
	601301 Earth Confetti / Bolgheri 7
	601302 Coffee Grounds / Bolgheri 4
	601763 Navy Blue / Albagia 288
	601764 Dusty Brown / Albagia 214
	601765 Black / Albagia 201
	601766 Riviera Blue / Wynwood 8
	601767 Carnival Red / Wynwood 13
	601768 Piazza Grey / Wynwood 10

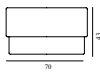

## Silo Pouf Medium

Colli: 1  
 Size & Weight: H: 43 x Ø: 70 cm - 12,8 kg  
 Packing: Brown Box - H: 43,5 x L: 71 x D: 71 cm - 15 kg  
 Material: Plywood, PU Foam and Textile  
 Production time: 6 weeks

	601303 Navy Blue / Albagia 288
	601304 Dusty Brown / Albagia 214
	601305 Black / Albagia 201
	601769 Deep Sea / Bolgheri 8
	601770 Earth Confetti / Bolgheri 7
	601771 Coffee Grounds / Bolgheri 4
	601772 Riviera Blue / Wynwood 8
	601773 Carnival Red / Wynwood 13
	601774 Piazza Grey / Wynwood 10

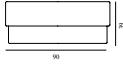

<b>Silo Pouf Large</b>	
Colli:	1
Size & Weight:	H: 39 x Ø: 90 cm - 18,6 kg
Packing:	Brown Box - H: 42 x L: 91,5 x D: 90 cm - 22 kg
Material:	Plywood, PU Foam and Textile
Production time:	6 weeks
	601306 Riviera Blue / Wynwood 8
	601307 Carnival Red / Wynwood 13
	601308 Piazza Grey / Wynwood 10
	601775 Deep Sea / Bolgheri 8
	601776 Earth Confetti / Bolgheri 7
	601777 Coffee Grounds / Bolgheri 4
	601778 Navy Blue / Albagia 288
	601779 Dusty Brown / Albagia 214
	601780 Black / Albagia 201

## SKO

Design: Simon Legald, 2013  
 Duty Code: 9403208000  
 Made in: China

Construction: The screws and bolts are accentuated in the design. Including tools for assembly as well an easy to follow manual. The large screws keep the frame in position and the shelves are easily put in place. Load capacity: 5 kg pr. shelf.

Maintenance: Clean with damp cloth.

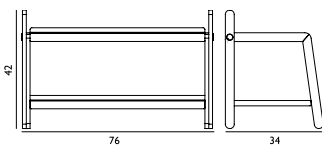

<b>Sko Shoe Rack</b>	
Colli:	1
Size & Weight:	H: 42 x L: 76 x D: 34 cm - 6,5 kg
Packing:	Brown Box - H: 46 x L: 83 x D: 19 cm - 9,8 kg
Material:	Steel, Ash
	601060 White
	601065 Grey

# SLICE

Design: Hans Hornemann, 2014  
Duty Code: 9403601000  
Made in: Denmark  
Construction: The tabletop (3 cm thick) consists of three planks supported by a wooden cross rail and a solid oak frame with legs. The table comes flat-packed. Assembly manual included.  
Maintenance: Wipe the table with a damp cloth and make sure to remove spills immediately so they don't leave stains.

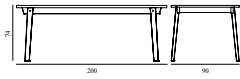

## Slice Table 90 x 200 cm

Colli: 1  
Size & Weight: H: 74 x W: 90 x L: 200 cm - 41,5 kg  
Packing: Brown box - H: 210 x L: 105 x D: 14 cm. Slice table 90 x 200 cm is packed on 1 pallet. - 49 kg  
M3: 0,3087  
Material: Tabletop: Lacquered Oak Veneer, Legs: Oak  
Production time: 5 weeks

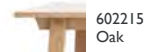

## Slice Table 90 x 250 cm

Colli: 1  
Size & Weight: H: 74 x W: 90 x L: 250 cm - 65 kg  
Packing: Brown Box - H: 260 x L: 105 x D: 14 cm. Slice table 90 x 250 cm is packed on 3 pallets. - 70 kg  
Material: Tabletop: Lacquered Oak Veneer, Legs: Oak  
Production time: 5 weeks

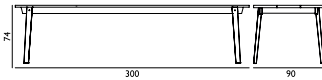
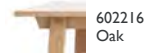

## Slice Table 90 x 300 cm

Colli: 1  
Size & Weight: H: 74 x W: 90 x L: 300 cm - 80 kg  
Packing: Brown Box - H: 310 x L: 105 x D: 14 cm. Slice table 90 x 300 cm is packed on 3 pallets. - 85 kg  
Material: Tabletop: Lacquered Oak Veneer, Legs: Oak  
Production time: 5 weeks

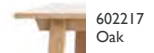

# SLICE VOL. 2

Design: Hans Hornemann, 2014  
Duty Code: 9403601000  
Made in: Denmark  
Construction: The table comes flat packed.  
Maintenance: Wipe the table with a damp cloth and make sure to remove spills immediately so they don't leave stains.

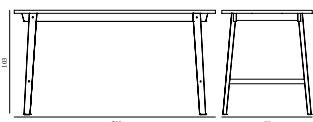

## Slice Bar Table Vol. 2 90 x 200 cm

Colli: 1  
Size & Weight: H: 103 x W: 90 x L: 200 cm - 44 kg  
Packing: Brown Box - H: 95 x L: 205 x D: 15 cm. Slice table 90 x 200 cm is packed on 1 pallet. - 49 kg  
Material: Tabletop: Lacquered Oak Veneer, Legs: Oak  
Production time: 5 weeks



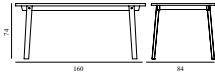

### Slice Table Vol. 2 84 x 160 cm

Colli: 1  
Size & Weight: H: 74 x W: 84 x L: 160 cm - 36 kg  
Packing: Brown Box - H: 10,5 x L: 164,5 x D: 89,5 cm  
Material: Tabletop: Lacquered Oak Veneer, Legs: Oak  
Production time: 5 weeks



603351  
Oak

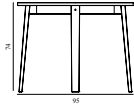

### Slice Table Vol. 2 Ø95 cm

Colli: 1  
Size & Weight: H: 74 x Ø: 95 cm - 26 kg  
Packing: Brown Box - H: 98 x L: 98 x D: 12 cm  
Material: Tabletop: Lacquered Oak Veneer, Legs: Oak  
Production time: 5 weeks

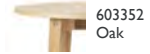

603352  
Oak

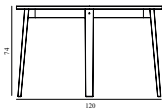

### Slice Table Vol. 2 Ø120 cm

Colli: 1  
Size & Weight: H: 74 x Ø: 120 cm - 37,5 kg  
Packing: Brown Box - H: 123 x L: 123 x D: 12 cm  
Material: Tabletop: Lacquered Oak Veneer, Legs: Oak  
Production time: 5 weeks



603353  
Oak

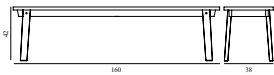

### Slice Bench Vol. 2 38 x 160 cm

Colli: 1  
Size & Weight: H: 42 x W: 38 x L: 160 cm - 20,5 kg  
Packing: Brown Box - H: 41 x L: 163 x D: 12 cm  
M3: 0,0802  
Material: Tabletop: Lacquered Oak Veneer, Legs: Oak  
Production time: 5 weeks



603354  
Oak

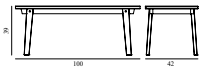

### Slice Coffee Table Vol. 2 42 x 100 cm

Colli: 1  
Size & Weight: H: 39 x W: 42 x L: 100 cm - 14,2 kg  
Packing: Brown Box - H: 43 x L: 103 x D: 12 cm  
Material: Tabletop: Lacquered Oak Veneer, Legs: Oak  
Production time: 5 weeks



603355  
Oak

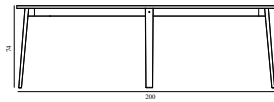

### Slice Table Vol. 2 Ø200 cm

Colli: 1  
Size & Weight: H: 74 x Ø: 200 cm - 70 kg  
Packing: Brown Box - 77 kg  
Material: Tabletop: Lacquered Oak Veneer, Legs: Oak  
Production time: 5 weeks



603349  
Oak

# SLICE LINOLEUM

Design: Hans Hornemann, 2015

Duty Code: 9403601000

Made in: Denmark

Construction: Linoleum is a natural material. The table comes flat packed.  
Assembly manual included.

Maintenance: Wipe with a damp cloth. Use a PH-neutral cleaning product.  
Thorough cleaning and maintenance: Use a special linoleum cleaner followed by a linoleum care product.

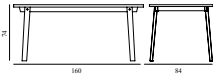

## Slice Table 84 x 160 cm Linoleum

Colli: 1  
Size & Weight: H: 74 x W: 84 x L: 160 cm - 31 kg  
Packing: Brown Box - H: 10,5 x L: 164,5 x D: 89,5 cm - 34 kg  
Material: Tabletop: Linoleum on particleboard, with oak veneer edges.  
Legs: Oak  
Production time: 5 weeks



603084  
Linoleum

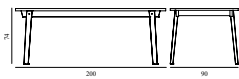

## Slice Table 90 x 200 cm Linoleum

Colli: 1  
Size & Weight: H: 74 x W: 90 x L: 200 cm - 42 kg  
Packing: Brown Box - H: 210 x L: 105 x D: 14 cm - 49 kg  
M3: 0,3087  
Material: Tabletop: Linoleum on particleboard, with oak veneer edges.  
Legs: Oak  
Production time: 5 weeks

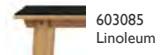

603085  
Linoleum



## Slice Table 90 x 250 cm Linoleum

Colli: 1  
Size & Weight: H: 74 x W: 90 x L: 250 cm - 65 kg  
Packing: Brown Box - H: 14 x L: 254,5 x D: 94 cm - 70 kg  
Material: Tabletop: Linoleum on particleboard, with oak veneer edges.  
Legs: Oak  
Production time: 5 weeks

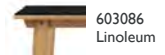

603086  
Linoleum

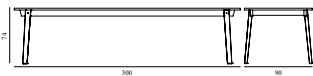

## Slice Table 90 x 300 cm Linoleum

Colli: 1  
Size & Weight: H: 74 x W: 90 x L: 300 cm - 69 kg  
Packing: Brown Box - H: 13,5 x L: 306 x D: 97 cm - 73 kg  
Material: Tabletop: Linoleum on particleboard, with oak veneer edges.  
Legs: Oak  
Production time: 5 weeks



603087  
Linoleum

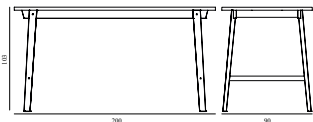

## Slice Bar Table 90 x 200 cm Linoleum

Colli: 1  
Size & Weight: H: 103 x W: 90 x L: 200 cm - 44 kg  
Packing: Brown Box - H: 103 x L: 200 x D: 90 cm - 49 kg  
M3: 1,854  
Material: Tabletop: Linoleum on particleboard, with oak veneer edges.  
Legs: Oak  
Production time: 5 weeks

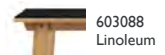

603088  
Linoleum

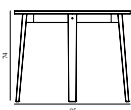

## Slice Table Ø95 cm Linoleum

Colli: 1  
Size & Weight: H: 74 x Ø: 95 cm - 26 kg  
Packing: Brown Box - H: 98 x L: 98 x D: 12 cm  
Material: Tabletop: Linoleum on particleboard, with oak veneer edges.  
Legs: Oak  
Production time: 5 weeks

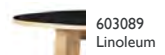

603089  
Linoleum



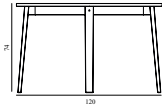

### Slice Table Ø120 cm Linoleum

Colli: 1  
 Size & Weight: H: 74 x Ø: 120 cm - 29 kg  
 Packing: Brown Box - H: 11,5 x L: 123 x D: 123 cm - 32 kg  
 Material: Tabletop: Linoleum on particleboard, with oak veneer edges.  
 Legs: Oak  
 Production time: 5 weeks

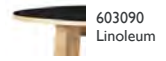

603090  
Linoleum

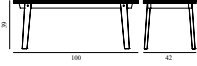

### Slice Coffee Table 42 x 100 cm Linoleum

Colli: 1  
 Size & Weight: H: 39 x W: 42 x L: 100 cm - 14,2 kg  
 Packing: Brown Box - H: 43 x L: 103 x D: 12 cm  
 Material: Tabletop: Linoleum on particleboard, with oak veneer edges.  
 Legs: Oak  
 Production time: 5 weeks



603091  
Linoleum



### Slice Bench 38 x 160 cm Linoleum

Colli: 1  
 Size & Weight: H: 42 x W: 39 x L: 160 cm - 20,5 kg  
 Packing: Brown Box - H: 41 x L: 163 x D: 12 cm  
 Material: Top: Linoleum on particleboard, with oak veneer edges. Legs: Oak  
 Production time: 5 weeks



603092  
Linoleum

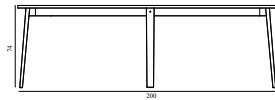

### Slice Table Ø200 cm Linoleum

Colli: 1  
 Size & Weight: H: 74 x Ø: 200 cm - 70 kg  
 Packing: Brown Box  
 Material: Top: Linoleum on particleboard, with oak veneer edges. Legs: Oak  
 Production time: 5 weeks

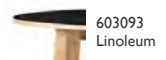

603093  
Linoleum

## SOLID

Design: Lars Beller Fjetland, 2013  
 Duty Code: 9403890000  
 Made in: China

Construction: The Solid table comes flat packed. Simple and intuitive to assemble without the use of any screws or tools. The parts lock together under the weight of the 25 mm thick tabletop, forming a sturdy construction.

Maintenance: Clean with a damp cloth. Use a PH-neutral cleaning product. Please be aware that sharp objects can leave marks.

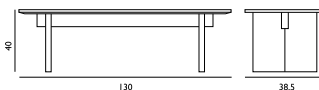

### Solid Table

Colli: 1  
 Size & Weight: H: 40 x W: 38,5 x L: 130 cm - 50 kg  
 Packing: Brown Box - H: 151 x L: 64 x D: 35 cm - 77 kg  
 Material: Tabletop: Marble. Base: Stained and lacquered Ash



602250  
White



607820  
Black



607821  
Coffee

# STAY

Design: Jonas Wagell, 2014  
 Duty Code: 9403208000  
 Made in: Denmark  
 Construction: Load capacity: Approx. 20 kg. Comes assembled.  
 Maintenance: Clean with damp cloth.

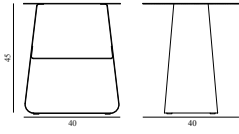

## Stay Table 40 x 40 cm

Colli: 1  
 Size & Weight: H: 45 x W: 40 x L: 40 cm - 7,5 kg  
 Packing: Brown Box - H: 44 x L: 44 x D: 51 cm - 9,2 kg  
 M3: 0,0987  
 Material: Steel



602219  
Stone Grey



602222  
Rust

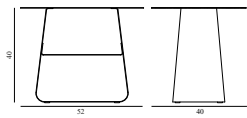

## Stay Table 40 x 52 cm

Colli: 1  
 Size & Weight: H: 40 x W: 40 x L: 52 cm - 8 kg  
 Packing: Brown Box - H: 56,5 x L: 44,5 x D: 45,5 cm - 10 kg  
 M3: 0,1144  
 Material: Steel

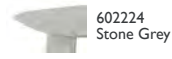

602224  
Stone Grey



602227  
Rust

# STOCK

Design: Msds Studio, 2018  
 Duty Code: 9403208000  
 Made in: China  
 Construction: Stock is made of either stainless steel or powder coated steel. The table is delivered assembled.  
 Maintenance: Clean with damp cloth.

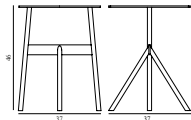

## Stock Table

Colli: 1  
 Size & Weight: H: 46 x Ø: 37 cm - 7 kg  
 Packing: Brown Box - H: 50,5 x L: 44 x D: 43 cm - 8 kg  
 Material: Powder coated steel



602526  
White



602527  
Wine

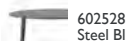

602528  
Steel Blue



602529  
Black

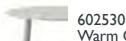

602530  
Warm Grey

## Stock Table Stainless Steel

Colli: 1  
 Size & Weight: H: 46 x Ø: 37 cm - 5,7 kg  
 Packing: Brown Box - H: 50,5 x L: 44 x D: 43 cm - 8 kg  
 Material: Stainless steel



602531  
Stainless Steel

# STUDIO CHAIR

Design: Simon Legald, 2018

Duty Code: 9401790000

Made in: Lithuania

Construction: Studio is made in molded oak veneer. Comes with a clear lacquer or in a painted version. Legs are made of powder coated steel tubes. Stackable.

Maintenance: Clean with damp cloth.

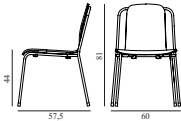

## Studio Chair Black Steel

Colli: 1

Size & Weight: H: 81 x W: 60 x D: 57,5 x SH: 44 cm - 5,3 kg

Packing: Brown Box - H: 92 x L: 65 x D: 60 cm - 7,9 kg

M3: 0,3588

Material: Shell: Lacquered Oak Veneer or Painted and Lacquered Ash Veneer; Legs: Powder Coated Steel

Production time: 2 weeks

 601781 Oak	 601782 Light Grey	 601783 Brown	 601784 Green
			 601785 Black









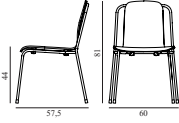





# STUDIO CHAIR FRONT UPHOLSTERY

Design: Simon Legald, 2018  
 Duty Code: 9401710000  
 Made in: Denmark

Construction: Studio is made in molded oak veneer and front upholstery.  
 Comes with a clear lacquer or in a painted version. Legs are made of powder coated steel tubes. Studio is stackable - but be aware that this can harm the upholstery.

Maintenance: Textile: Clean with textile or upholstery cleaner. Leather: Clean with damp cloth. Use warm water with soap flakes. Frequent vacuuming with a soft fitting is recommended for both textile and leather to preserve color and appearance.



<b>Studio Chair Front Upholstery Black Steel</b>	
Colli:	1
Size & Weight:	H: 81 x W: 60 x D: 57,5 x SH: 44 cm - 5,7 kg
Packing:	Brown Box - H: 92 x L: 65 x D: 60 cm - 8,3 kg
Material:	Shell: Lacquered Oak Veneer or Painted and Lacquered Ash Veneer and Front Upholstery, Legs: Powder Coated Steel
Production time: 5 weeks	
	601861 Oak / Main Line Flax
	601862 Oak / Synergy
	601863 Oak / Ultra Leather
	601864 Light Grey / Ultra Leather
	601865 Light Grey / Synergy
	601866 Light Grey / Main Line Flax
	601867 Brown / Main Line Flax
	601868 Brown / Synergy
	601869 Brown / Ultra Leather
	601870 Green / Main Line Flax
	601871 Green / Synergy
	601872 Green / Ultra Leather
	601873 Black / Main Line Flax
	601874 Black / Synergy
	601875 Black / Ultra Leather

# STUDIO CHAIR FULL UPHOLSTERY

Design: Simon Legald, 2018  
 Duty Code: 9401710000  
 Construction: Studio is made in molded oak veneer and full upholstery. Legs are made of powder coated steel tubes. Studio is stackable - but be aware that this can harm the upholstery.  
 Maintenance: Textile: Clean with textile or upholstery cleaner. Leather: Clean with damp cloth. Use warm water with soap flakes. Frequent vacuuming with a soft fitting is recommended for both textile and leather to preserve color and appearance.

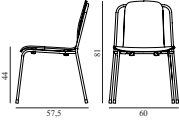

<b>Studio Chair Full Upholstery Black Steel</b>	
Colli:	1
Size & Weight:	H: 81 x W: 60 x D: 57,5 x SH: 44 cm - 6 kg
Packing:	Brown Box - H: 92 x L: 65 x D: 60 cm - 8,6 kg
M3:	0,3588
Material:	Shell: Full Upholstery, Legs: Powder Coated Steel
Production time: 5 weeks	
	601876 Synergy
	601877 Main Line flax
	601878 Ultra Leather

# STUDIO ARMCHAIR

Design: Simon Legald, 2018  
 Duty Code: 9401790000  
 Made in: Lithuania  
 Construction: Studio is made in molded oak veneer. Comes with a clear lacquer or in a painted version. Legs are made of powder coated steel tubes. Stackable.  
 Maintenance: Clean with damp cloth.

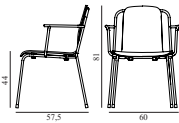

<b>Studio Armchair Black Steel</b>			
Colli: 1			
Size & Weight: H: 81 x W: 60 x D: 57,5 x SH: 44 cm - 6,8 kg			
Packing: Brown Box - H: 92 x L: 65 x D: 65 cm - 9,6 kg			
M3: 0,3887			
Material: Shell: Lacquered Oak Veneer or Painted and Lacquered Ash Veneer, Legs: Powder Coated Steel			
Production time: 2 weeks			
	601786 Oak		601787 Light Grey
	601788 Brown		601789 Green
			601790 Black

# STUDIO ARMCHAIR FRONT UPHOLSTERY

Design: Simon Legald, 2018

Duty Code: 9401710000

Construction: Studio is made in molded oak veneer and front upholstery. Comes with a clear lacquer or in a painted version. Legs are made of powder coated steel tubes. Studio is stackable - but be aware that this can harm the upholstery.

Maintenance: Textile: Clean with textile or upholstery cleaner. Leather: Clean with damp cloth. Use warm water with soap flakes. Frequent vacuuming with a soft fitting is recommended for both textile and leather to preserve color and appearance.

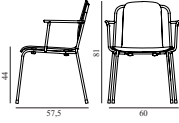

## Studio Armchair Front Upholstery Black Steel

Colli: 1  
 Size & Weight: H: 81 x W: 60 x D: 57,5 x SH: 44 cm - 7,2 kg  
 Packing: Brown Box - H: 92 x L: 65 x D: 65 cm - 10 kg  
 M3: 0,3887  
 Material: Shell: Lacquered Oak Veneer or Painted and Lacquered  
 Ash Veneer and Front Upholstery, Legs: Powder Coated Steel  
 Production time: 5 weeks

	601879 Black / Synergy
	601880 Black / Main Line Flax
	601881 Black / Ultra Leather
	601882 Oak / Synergy
	601883 Oak / Main Line Flax
	601884 Oak / Ultra Leather
	601885 Light Grey / Synergy
	601886 Light Grey / Main Line Flax
	601887 Light Grey / Ultra Leather
	601888 Brown / Synergy
	601889 Brown / Main Line Flax
	601890 Brown / Ultra Leather
	601891 Green / Synergy
	601892 Green / Main Line Flax
	601893 Green / Ultra Leather

# STUDIO ARMCHAIR FULL UPHOLSTERY

Design: Simon Legald, 2018  
 Duty Code: 9401710000  
 Made in: Denmark  
 Construction: Studio is made in molded oak veneer and full upholstery.  
 Legs are made of powder coated steel tubes. Studio is stackable - but be aware that this can harm the upholstery.  
 Maintenance: Textile: Clean with textile or upholstery cleaner. Leather: Clean with damp cloth. Use warm water with soap flakes. Frequent vacuuming with a soft fitting is recommended for both textile and leather to preserve color and appearance.

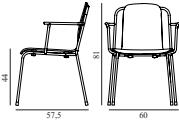

## Studio Armchair Full Upholstery Black Steel

Colli: 1  
 Size & Weight: H: 81 x W: 60 x D: 57,5 x SH: 44 cm - 7,6 kg  
 Packing: Brown Box - H: 92 x L: 65 x D: 65 cm - 10,4 kg  
 Material: Shell: Full Upholstery, Legs: Powder Coated Steel  
 Production time: 5 weeks

 601935  
Main Line flax

 601936  
Synergy

 601937  
Ultra Leather

# STUDIO BARSTOOL

Design: Simon Legald, 2018  
 Duty Code: 9401790000  
 Made in: Lithuania  
 Construction: Studio is made in molded oak veneer. Comes with a clear lacquer or in a painted version. Legs are made of powder coated steel tubes. Stackable.  
 Maintenance: Clean with damp cloth.

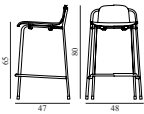

## Studio Barstool 65 cm Black Steel

Colli: 1  
 Size & Weight: H: 80 x W: 48 x D: 47 x SH: 65 cm - 5,3 kg  
 Packing: Brown Box - H: 92 x L: 56 x D: 53 cm - 7,7 kg  
 M3: 0,273 l  
 Material: Shell: Lacquered Oak Veneer or Painted and Lacquered Ash Veneer, Legs: Powder Coated Steel  
 Production time: 2 weeks

 601791  
Oak

 601792  
Light Grey

 601793  
Brown

 601794  
Green

 601795  
Black

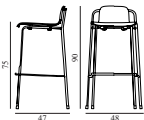



## Studio Barstool 75 cm Black Steel

Colli: 1  
 Size & Weight: H: 90 x W: 48 x D: 47 x SH: 75 cm - 5,6 kg  
 Packing: Brown Box - H: 102,5 x L: 56 x D: 53 cm - 8 kg  
 Material: Shell: Lacquered Oak Veneer or Painted and Lacquered Ash Veneer, Legs: Powder Coated Steel  
 Production time: 2 weeks

 601796  
Oak

 601797  
Light Grey

 601798  
Brown

 601799  
Green

 601800  
Black

# STUDIO BARSTOOL FRONT UPHOLSTERY

Design: Simon Legald, 2018

Duty Code: 9401710000

Construction: Studio is made in molded oak veneer and front upholstery. Comes with a clear lacquer or in a painted version. Legs are made of powder coated steel tubes. Studio is stackable - but be aware that this can harm the upholstery.

Maintenance: Textile: Clean with textile or upholstery cleaner. Leather: Clean with damp cloth. Use warm water with soap flakes. Frequent vacuuming with a soft fitting is recommended for both textile and leather to preserve color and appearance.

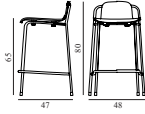

## Studio Barstool 65 cm Front Upholstery Black Steel

Colli: 1  
 Size & Weight: H: 80 x W: 48 x D: 47 x SH: 65 cm - 5,6 kg  
 Packing: Brown Box - H: 92 x L: 56 x D: 53 cm - 8 kg  
 M3: 0,273 l  
 Material: Shell: Lacquered Oak Veneer or Painted and Lacquered  
 Ash Veneer and Front Upholstery, Legs: Powder Coated Steel  
 Production time: 5 weeks





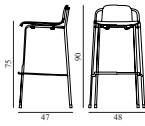









	601894 Oak / Synergy
	601895 Oak / Main Line Flax
	601896 Oak / Ultra Leather
	601897 Light Grey / Synergy
	601898 Light Grey / Main Line Flax
	601899 Light Grey / Ultra Leather
	601911 Brown / Synergy
	601912 Brown / Main Line Flax
	601913 Brown / Ultra Leather
	601914 Green / Synergy
	601915 Green / Main Line Flax
	601916 Green / Ultra Leather
	601917 Black / Synergy
	601918 Black / Main Line Flax
	601919 Black / Ultra Leather





**Studio Barstool 75 cm Front Upholstery Black Steel**

Colli: 1  
 Size & Weight: H: 90 x W: 48 x D: 47 x SH: 75 cm - 5,9 kg  
 Packing: Brown Box - H: 102 x L: 56 x D: 53 cm - 8,3 kg  
 M3: 0,3027  
 Material: Shell: Lacquered Oak Veneer or Painted and Lacquered  
 Ash Veneer and Front Upholstery, Legs: Powder Coated Steel  
 Production time: 5 weeks

	601920 Oak / Main Line Flax
	601921 Oak / Synergy
	601922 Oak / Ultra Leather
	601923 Light Grey / Main Line Flax
	601924 Light Grey / Synergy
	601925 Light Grey / Ultra Leather
	601926 Brown / Main Line Flax
	601927 Brown / Synergy
	601928 Brown / Ultra Leather
	601929 Green / Main Line Flax
	601930 Green / Synergy
	601931 Green / Ultra Leather
	601932 Black / Main Line Flax
	601933 Black / Synergy
	601934 Black / Ultra Leather

# STUDIO BARSTOOL FULL UPHOLSTERY

Design: Simon Legald, 2018

Duty Code: 9401710000

Made in: Denmark

Construction: Studio is made in molded oak veneer and full upholstery.

Legs are made of powder coated steel tubes. Studio is stackable - but be aware that this can harm the upholstery.

Maintenance: Textile: Clean with textile or upholstery cleaner. Leather:

Clean with damp cloth. Use warm water with soap flakes.

Frequent vacuuming with a soft fitting is recommended for both textile and leather to preserve color and appearance.

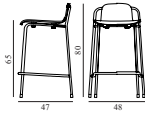

## Studio Barstool 65 cm Full Upholstery Black Steel

Colli: 1  
 Size & Weight: H: 80 x W: 48 x D: 47 x SH: 65 cm - 5,9 kg  
 Packing: Brown Box - H: 92 x L: 56 x D: 53 cm - 8,3 kg  
 M3: 0,273 l  
 Material: Shell: Full Upholstery, Legs: Powder Coated Steel  
 Production time: 5 weeks

 601938  
Main Line flax

 601939  
Synergy

 601940  
Ultra Leather



## Studio Barstool 75 cm Full Upholstery Black Steel

Colli: 1  
 Size & Weight: H: 90 x W: 48 x D: 47 x SH: 75 cm - 6,2 kg  
 Packing: Brown Box - H: 102 x L: 56 x D: 53 cm - 8,6 kg  
 Material: Shell: Full Upholstery, Legs: Powder Coated Steel  
 Production time: 5 weeks

 601941  
Main Line Flax

 601942  
Synergy

 601943  
Ultra Leather

# STUDIO BAR CHAIR

Design: Simon Legald, 2020

Duty Code: 9401790000

Made in: Lithuania

Construction: Studio bar chair is made in molded oak veneer. Comes with a clear lacquer or in a painted version. Legs are made of powder coated steel tubes.

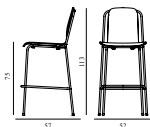



## Studio Bar Chair 75 cm Black Steel

Colli: 1  
 Size & Weight: H: 113 x W: 52 x D: 57 x SH: 75 cm - 7,3 kg  
 Packing: Brown Box - H: 114,5 x L: 54 x D: 59 cm - 9,3 kg  
 Material: Shell: Lacquered or painted and lacquered oak veneer; Legs: Powder coated steel.  
 Production time: 2 weeks

 601950  
Oak

 601951  
Light Grey

 601952  
Brown

 601953  
Green

 601954  
Black

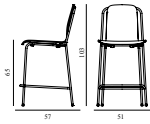

### Studio Bar Chair 65 cm Black Steel

Colli: 1  
 Size & Weight: H: 103 x W: 52 x D: 57 x SH: 65 cm - 7 kg  
 Packing: Brown Box - H: 104,5 x L: 53 x D: 59 cm - 9 kg  
 Material: Shell: Lacquered or painted and lacquered oak veneer; Legs: Powder coated steel.  
 Production time: 2 weeks

 601955 Oak	 601956 Light Grey	 601957 Brown	 601958 Green
			 601959 Black

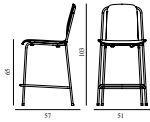

## STUDIO BAR CHAIR FRONT UPHOLSTERY

Design: Simon Legald, 2020  
 Duty Code: 9401710000  
 Made in: Lithuania  
 Construction: Studio bar chair is made in molded oak veneer and full upholstery. Legs are made of powder coated steel tubes.  
 Maintenance: Textile: Clean with textile or upholstery cleaner. Leather: Clean with damp cloth. Use warm water with soap flakes. Frequent vacuuming with a soft fitting is recommended for both textile and leather to preserve color and appearance.



### Studio Bar Chair 65 cm Front Upholstery Black Steel

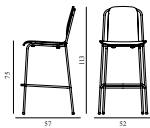

Colli: 1  
 Size & Weight: H: 103 x W: 51 x D: 57 x SH: 65 cm - 7,3 kg  
 Packing: Brown Box - H: 104,5 x L: 53 x D: 59 cm - 9,2 kg  
 Material: Shell: Lacquered oak veneer or painted and lacquered ash veneer and front upholstery; Legs: Powder coated steel.  
 Production time: 5 weeks

 601977 Main Line Flax
 601978 Synergy
 601979 Ultra Leather



### Studio Bar Chair 75 cm Front Upholstery Black Steel

Colli: 1  
 Size & Weight: H: 113 x W: 52 x D: 57 x SH: 75 cm - 7,6 kg  
 Packing: Brown Box - H: 114,5 x L: 54 x D: 59 cm - 9,5 kg  
 Material: Shell: Lacquered oak veneer or painted and lacquered ash veneer and front upholstery; Legs: Powder coated steel.  
 Production time: 5 weeks

 601970 Main Line Flax
 601971 Synergy
 601972 Ultra Leather

# STUDIO BAR CHAIR FULL UPHOLSTERY

Design: Simon Legald, 2020  
 Duty Code: 9401710000  
 Made in: Lithuania  
 Construction: Studio bar chair is made in molded oak veneer and full upholstery. Legs are made of powder coated steel tubes.  
 Maintenance: Textile: Clean with textile or upholstery cleaner. Leather: Clean with damp cloth. Use warm water with soap flakes. Frequent vacuuming with a soft fitting is recommended for both textile and leather to preserve color and appearance.

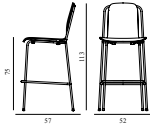

## Studio Bar Chair 75 cm Full Upholstery Black Steel

Colli: 1  
 Size & Weight: H: 113 x W: 52 x D: 57 x SH: 75 cm - 7,9 kg  
 Packing: Brown Box - H: 114,5 x L: 54 x D: 59 cm - 9,6 kg  
 Material: Shell: Lacquered oak veneer or painted and lacquered ash veneer and full upholstery, Legs: Powder coated steel.  
 Production time: 5 weeks

 601998  
Main Line Flax

 601999  
Synergy

 602403  
Ultra Leather

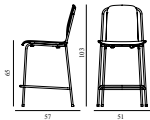

## Studio Bar Chair 65 cm Full Upholstery Black Steel

Colli: 1  
 Size & Weight: H: 103 x W: 51 x D: 57 x SH: 65 cm - 7,6 kg  
 Packing: Brown Box - H: 104,5 x L: 53 x D: 59 cm - 9,3 kg  
 Material: Shell: Lacquered oak veneer or painted and lacquered ash veneer and full upholstery, Legs: Powder coated steel.  
 Production time: 5 weeks

 602408  
Main Line Flax

 602409  
Synergy

 602476  
Ultra Leather

# STUDIO BAR ARMCHAIR

Design: Simon Legald, 2020  
 Duty Code: 9401790000  
 Made in: Lithuania  
 Construction: Studio bar chair is made in molded oak veneer. Comes with a clear lacquer or in a painted version. Legs are made of powder coated steel tubes.

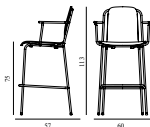



## Studio Bar Armchair 75 cm Black Steel

Colli: 1  
 Size & Weight: H: 113 x W: 60 x D: 57 x SH: 75 cm - 8,9 kg  
 Packing: Brown Box - H: 114,5 x L: 59 x D: 62 cm - 10,9 kg  
 Material: Shell: Lacquered or painted and lacquered oak veneer, Legs: Powder coated steel.  
 Production time: 2 weeks

 601960  
Oak

 601961  
Light Grey

 601962  
Brown

 601963  
Green

 601964  
Black

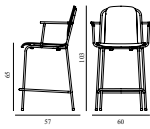

### Studio Bar Armchair 65 cm Black Steel

Colli: 1  
 Size & Weight: H: 103 x W: 51 x D: 57 x SH: 65 cm - 8,6 kg  
 Packing: Brown Box - H: 104,5 x L: 59 x D: 62 cm - 10,6 kg  
 Material: Shell: Lacquered or painted and lacquered oak veneer; Legs: Powder coated steel.  
 Production time: 2 weeks

 601965 Oak	 601966 Light Grey	 601967 Brown	 601968 Green
			 601969 Black

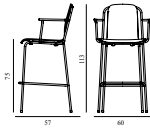

## STUDIO BAR ARMCHAIR FRONT UPHOLSTERY

Design: Simon Legald, 2020  
 Duty Code: 9401710000  
 Made in: Lithuania  
 Construction: Studio bar chair is made in molded oak veneer and full upholstery. Legs are made of powder coated steel tubes.  
 Maintenance: Textile: Clean with textile or upholstery cleaner. Leather: Clean with damp cloth. Use warm water with soap flakes. Frequent vacuuming with a soft fitting is recommended for both textile and leather to preserve color and appearance.



### Studio Bar Armchair 75 cm Front Upholstery Black Steel

Colli: 1  
 Size & Weight: H: 113 x W: 60 x D: 57 x SH: 75 cm - 9,2 kg  
 Packing: Brown Box - H: 114,5 x L: 59 x D: 62 cm - 11,1 kg  
 Material: Shell: Lacquered oak veneer or painted and lacquered ash veneer and front upholstery; Legs: Powder coated steel.

 601984 Main Line Flax
 601985 Synergy
 601986 Ultra Leather

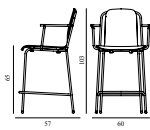

### Studio Bar Armchair 65 cm Front Upholstery Black Steel

Colli: 1  
 Size & Weight: H: 103 x W: 60 x D: 57 x SH: 65 cm - 8,9 kg  
 Packing: Brown Box - H: 104,5 x L: 59 x D: 62 cm - 10,8 kg  
 Material: Shell: Lacquered oak veneer or painted and lacquered ash veneer and front upholstery; Legs: Powder coated steel.

 601991 Main Line Flax
 601992 Synergy
 601993 Ultra Leather

# STUDIO BAR ARMCHAIR FULL UPHOLSTERY

Design: Simon Legald, 2020  
 Duty Code: 9401710000  
 Made in: Lithuania  
 Construction: Studio bar chair is made in molded oak veneer and full upholstery. Legs are made of powder coated steel tubes.  
 Maintenance: Textile: Clean with textile or upholstery cleaner. Leather: Clean with damp cloth. Use warm water with soap flakes. Frequent vacuuming with a soft fitting is recommended for both textile and leather to preserve color and appearance.

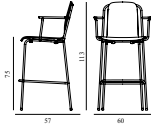

## Studio Bar Armchair 75 cm Full Upholstery Black Steel

Colli: 1  
 Size & Weight: H: 113 x W: 60 x D: 57 x SH: 75 cm - 9,5 kg  
 Packing: Brown Box - H: 114,5 x L: 59 x D: 62 cm - 11,2 kg  
 Material: Shell: Lacquered oak veneer or painted and lacquered ash veneer and full upholstery, Legs: Powder coated steel.  
 Production time: 5 weeks

 602481  
Main Line Flax

 602482  
Synergy

 602483  
Ultra Leather

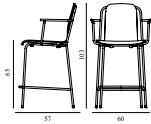

## Studio Bar Armchair 65 cm Full Upholstery Black Steel

Colli: 1  
 Size & Weight: H: 103 x W: 60 x D: 57 x SH: 65 cm - 9,2 kg  
 Packing: Brown Box - H: 104,5 x L: 59 x D: 62 cm - 10,9 kg  
 Material: Shell: Lacquered oak veneer or painted and lacquered ash veneer and full upholstery, Legs: Powder coated steel.

 602488  
Main Line Flax

 602489  
Synergy

 602490  
Ultra Leather

# STUDIO GLIDES

Duty Code: 9401999090  
 Construction: Different types of flooring require different types of glides.  
 Maintenance: We recommend to check the glides every 3-6 months. If worn down, please replace.

## Studio Chair & Barstool Glides

 900100  
PE for steel /  
Black /  
4pcs

 900101  
PE for steel w. felt /  
Black /  
4pcs

# STUDIO CHAIR LINK

Design: Simon Legald, 2018  
 Duty Code: 9401999090

## Studio Chair Link

900102  
Black

## SUM LOUNGE ARMCHAIR ALU

Design: Simon Legald, 2018  
 Duty Code: 9401710000  
 Made in: Lithuania

Construction: The Sum modules are made of soft molded PU foam with a steel reinforcement structure inside. The cushion is made of cut PU foam. Textile or leather upholstery. The sofa is easily assembled. Assembly manual included.

Maintenance: Textile: Clean with textile or upholstery cleaner. Leather: Clean with a damp cloth. Use warm water with soap flakes. Frequent vacuuming with a soft fitting is recommended for both textile and leather to preserve color and appearance.

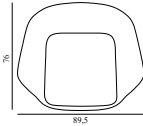

### Sum Armchair Alu

Size & Weight: H: 76 x W: 89,5 x D: 76 x SH: 41 cm - 20 kg  
 Packing: Brown Box - H: 80 x L: 120 x D: 80 cm - 24 kg  
 Material: PU Foam. Legs: Aluminium.  
 Production time: 6 weeks

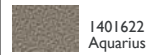

1401622  
Aquarius



1401623  
Oceanic

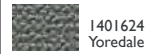

1401624  
Yoredale

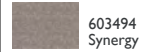

603494  
Synergy



603495  
Main Line flax



603496  
Ultra Leather

## SUM LOUNGE ARMCHAIR BLACK ALU

Design: Simon Legald, 2018  
 Duty Code: 9401710000  
 Made in: Lithuania

Construction: The Sum modules are made of soft molded PU foam with a steel reinforcement structure inside. The cushion is made of cut PU foam. Textile or leather upholstery. The sofa is easily assembled. Assembly manual included.

Maintenance: Textile: Clean with textile or upholstery cleaner. Leather: Clean with a damp cloth. Use warm water with soap flakes. Frequent vacuuming with a soft fitting is recommended for both textile and leather to preserve color and appearance.

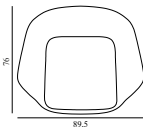

### Sum Armchair Black Alu

Size & Weight: H: 76 x W: 89,5 x D: 76 x SH: 41 cm - 21 kg  
 Packing: Brown Box - H: 80 x L: 120 x D: 80 cm - 25 kg  
 Material: PU Foam. Legs: Black Aluminium  
 Production time: 6 weeks

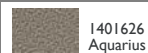

1401626  
Aquarius



1401627  
Oceanic

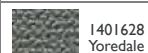

1401628  
Yoredale

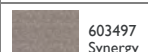

603497  
Synergy



603498  
Main Line flax



603499  
Ultra Leather

# SUM MODULAR SOFA ALU

Design: Simon Legald, 2018

Duty Code: 9401710000

Made in: Lithuania

Construction: The Sum modules are made of soft molded PU foam with a steel reinforcement structure inside. The cushion is made of cut PU foam. Textile or leather upholstery. The sofa is easily assembled. Assembly manual included.

Maintenance: Textile: Clean with textile or upholstery cleaner. Leather: Clean with a damp cloth. Use warm water with soap flakes. Frequent vacuuming with a soft fitting is recommended for both textile and leather to preserve color and appearance.

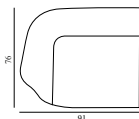

## Sum Modular Sofa 100 Left Armrest Alu

Colli: 1  
 Size & Weight: H: 76 x W: 91 x D: 76 x SH: 41 cm - 23 kg  
 Colli Box: - 30 kg  
 Material: PU Foam. Legs: Aluminium.  
 Production time: 6 weeks



1401630  
Aquarius



1401631  
Oceanic



1401632  
Yoredale



603500  
Synergy



603501  
Main Line flax



603502  
Ultra Leather

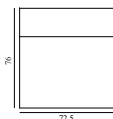

## Sum Modular Sofa 110 Center Alu

Colli: 1  
 Size & Weight: H: 76 x W: 72,5 x D: 76 x SH: 41 cm - 22 kg  
 Colli Box: - 26,5 kg  
 Material: PU Foam. Legs: Aluminium.  
 Production time: 6 weeks



1401634  
Aquarius



1401635  
Oceanic



1401636  
Yoredale



603506  
Synergy



603507  
Main Line flax



603508  
Ultra Leather



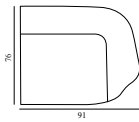

### Sum Modular Sofa 120 Right Armrest Alu

Colli: 1  
 Size & Weight: H: 76 x W: 91 x D: 76 x SH: 41 cm - 23 kg  
 Colli Box: - 30 kg  
 Material: PU Foam. Legs: Aluminium.  
 Production time: 6 weeks

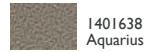

1401638  
 Aquarius

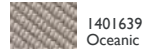

1401639  
 Oceanic

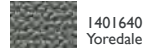

1401640  
 Yoredale

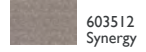

603512  
 Synergy



603513  
 Main Line flax

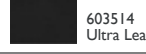

603514  
 Ultra Leather

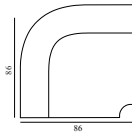

### Sum Modular Sofa 150 Corner Alu

Colli: 1  
 Size & Weight: H: 76 x W: 86 x D: 86 x SH: 41 cm - 27 kg  
 Packing: Brown Box - H: 83 x L: 101 x D: 95 cm - 33 kg  
 Material: PU Foam. Legs: Aluminium.  
 Production time: 6 weeks



1401642  
 Aquarius



1401643  
 Oceanic

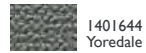

1401644  
 Yoredale

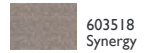

603518  
 Synergy



603519  
 Main Line flax



603520  
 Ultra Leather

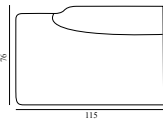

### Sum Modular Sofa 330 Open Left Side Alu

Colli: 1  
 Size & Weight: H: 76 x W: 115 x D: 76 x SH: 41 cm - 29 kg  
 Packing: Brown Box - H: 75 x L: 119 x D: 80 cm - 33 kg  
 Material: PU Foam. Legs: Aluminium.  
 Production time: 6 weeks



1401646  
 Aquarius



1401647  
 Oceanic



1401648  
 Yoredale

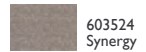

603524  
 Synergy



603525  
 Main Line flax



603526  
 Ultra Leather

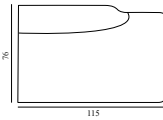

### Sum Modular Sofa 340 Open Right Side Alu

Colli: 1  
 Size & Weight: H: 76 x W: 115 x D: 76 x SH: 41 cm - 29 kg  
 Packing: Brown Box - H: 75 x L: 119 x D: 80 cm - 33 kg  
 Material: PU Foam. Legs: Aluminium.  
 Production time: 6 weeks

	1401650 Aquarius
	1401651 Oceanic
	1401652 Yoredale
	603530 Synergy
	603531 Main Line flax
	603532 Ultra Leather

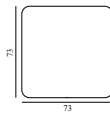

### Sum Modular Sofa 700 Pouf Small Alu

Size & Weight: H: 41 x W: 73 x D: 73 x SH: 41 cm - 23,5 kg  
 Material: PU Foam. Legs: Aluminium.  
 Production time: 6 weeks

	1401654 Aquarius
	1401655 Oceanic
	1401656 Yoredale
	603536 Synergy
	603537 Main Line flax
	603538 Ultra Leather

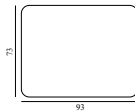

### Sum Modular Sofa 710 Pouf Large Alu

Colli: 1  
 Size & Weight: H: 41 x W: 93 x D: 73 x SH: 41 cm - 25,5 kg  
 Packing: Brown Box - H: 47,9 x L: 118,6 x D: 78,6 cm - 25,5 kg  
 Material: PU Foam. Legs: Aluminium.  
 Production time: 6 weeks

	1401658 Aquarius
	1401659 Oceanic
	1401660 Yoredale
	603542 Synergy
	603543 Main Line flax
	603544 Ultra Leather

# SUM MODULAR SOFA BLACK ALU

Design: Simon Legald, 2018

Duty Code: 9401710000

Made in: Lithuania

Construction: The Sum modules are made of soft molded PU foam with a steel reinforcement structure inside. The cushion is made of cut PU foam. Textile or leather upholstery. The sofa is easily assembled. Assembly manual included.

Maintenance: Textile: Clean with textile or upholstery cleaner. Leather: Clean with a damp cloth. Use warm water with soap flakes. Frequent vacuuming with a soft fitting is recommended for both textile and leather to preserve color and appearance.

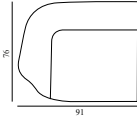

## Sum Modular Sofa 100 Left Armrest Black Alu

Colli: 1  
 Size & Weight: H: 76 x W: 91 x D: 76 x SH: 41 cm - 24 kg  
 Colli Box: - 30 kg  
 Material: PU Foam. Legs: Black Aluminium.  
 Production time: 6 weeks

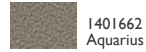

1401662  
Aquarius

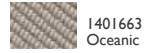

1401663  
Oceanic

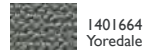

1401664  
Yoredale

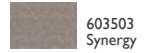

603503  
Synergy



603504  
Main Line flax



603505  
Ultra Leather

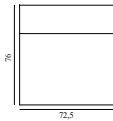

## Sum Modular Sofa 110 Center Black Alu

Size & Weight: H: 76 x W: 72,5 x D: 76 x SH: 41 cm - 23 kg  
 Material: PU Foam. Legs: Black Aluminium.  
 Production time: 6 weeks

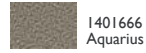

1401666  
Aquarius

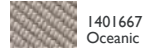

1401667  
Oceanic

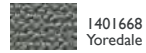

1401668  
Yoredale

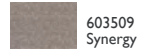

603509  
Synergy



603510  
Main Line flax



603511  
Ultra Leather

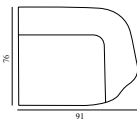

## Sum Modular Sofa 120 Right Armrest Black Alu

Colli: 1  
 Size & Weight: H: 76 x W: 91 x D: 76 x SH: 41 cm - 24 kg  
 Colli Box: - 30 kg  
 Material: PU Foam. Legs: Black Aluminium.  
 Production time: 6 weeks

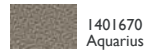

1401670  
Aquarius

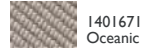

1401671  
Oceanic

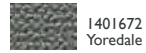

1401672  
Yoredale

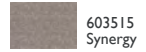

603515  
Synergy



603516  
Main Line flax



603517  
Ultra Leather

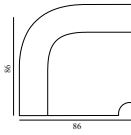

**Sum Modular Sofa 150 Corner Black Alu**

Colli: 1  
 Size & Weight: H: 76 x W: 86 x D: 86 x SH: 41 cm - 28 kg  
 Packing: Brown Box - H: 83 x L: 101 x D: 95 cm - 34 kg  
 Material: PU Foam. Legs: Black Aluminium.  
 Production time: 6 weeks

	1401674 Aquarius
	1401675 Oceanic
	1401676 Yoredale
	603521 Synergy
	603522 Main Line flax
	603523 Ultra Leather

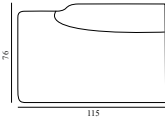

**Sum Modular Sofa 330 Open Left Side Black Alu**

Colli: 1  
 Size & Weight: H: 76 x W: 115 x D: 76 x SH: 41 cm - 30 kg  
 Packing: Brown Box - H: 75 x L: 119 x D: 80 cm - 34 kg  
 Material: PU Foam. Legs: Black Aluminium.  
 Production time: 6 weeks

	1401678 Aquarius
	1401679 Oceanic
	1401680 Yoredale
	603527 Synergy
	603528 Main Line flax
	603529 Ultra Leather

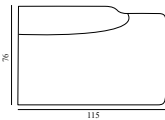

**Sum Modular Sofa 340 Open Right Side Black Alu**

Colli: 1  
 Size & Weight: H: 76 x W: 115 x D: 76 x SH: 41 cm - 30 kg  
 Packing: Brown Box - H: 75 x L: 119 x D: 80 cm - 34 kg  
 Material: PU Foam. Legs: Black Aluminium.  
 Production time: 6 weeks

	1401682 Aquarius
	1401683 Oceanic
	1401684 Yoredale
	603533 Synergy
	603534 Main Line flax
	603535 Ultra Leather

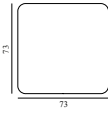

**Sum Modular Sofa 700 Pouf Small Black Alu**

Colli: 1  
 Size & Weight: H: 41 x W: 73 x D: 73 x SH: 41 cm - 23,5 kg  
 Packing: Brown Box - H: 47,9 x L: 118,6 x D: 78,6 cm - 23,5 kg  
 Material: PU Foam. Legs: Black Aluminium.  
 Production time: 6 weeks

	1401686 Aquarius
	1401687 Oceanic
	1401688 Yoredale
	603539 Synergy
	603540 Main Line flax
	603541 Ultra Leather

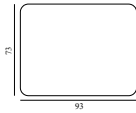

**Sum Modular Sofa 710 Pouf Large Black Alu**

Colli: 1  
 Size & Weight: H: 41 x W: 93 x D: 73 x SH: 41 cm - 25,5 kg  
 Packing: Brown Box - H: 47,9 x L: 118,6 x D: 78,6 cm - 25,5 kg  
 Material: PU Foam. Legs: Black Aluminium.  
 Production time: 6 weeks

	1401690 Aquarius
	1401691 Oceanic
	1401692 Yoredale
	603545 Synergy
	603546 Main Line flax
	603547 Ultra Leather

# SWELL

Design: Jonas Wagell, 2013

Duty Code: 9401610000

Made in: Poland

Construction: Swell consists of a solid wooden plywood frame with Nozaq springs with HR 38 cold foam on the seat and HR 35 cold foam on the back and armrests. Over this, is a layer of supersoft S25 cold foam which ensures optimal comfort. The legs are made of painted ash.

Maintenance: Clean with textile or upholstery cleaner. Frequent vacuuming with a soft fitting is recommended to preserve color and appearance.

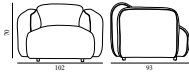

## Swell Armchair

Colli: 1  
 Size & Weight: H: 70 x W: 102 x D: 93 x SH: 42 cm - 12,8 kg  
 Packing: Brown box - Swell Armchair is packed on 1 pallet in 1 box: 1,15 m high - 69 kg  
 M3: 0,8247  
 Material: HR Foam, Plywood, Upholstery; Camira/ Main Line Flax, Synergy, Aquarius, Oceanic, Yoredale. Legs: Painted and Lacquered Ash.  
 Production time: 6 weeks

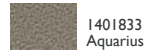

1401833  
Aquarius



1401834  
Oceanic

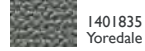

1401835  
Yoredale



603108  
Main Line flax



603109  
Synergy

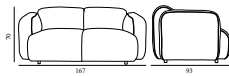

## Swell Sofa 2 Seater

Colli: 1  
 Size & Weight: H: 70 x W: 167 x D: 93 x SH: 42 cm - 35,8 kg  
 Packing: Brown boxes - Swell 2 seater is packed on 1 pallet in 2 boxes: 1,95 m high - 86 kg  
 Material: HR Foam, Plywood, Upholstery; Camira/ Main Line Flax, Synergy, Aquarius, Oceanic, Yoredale. Legs: Painted and Lacquered Ash.  
 Production time: 6 weeks



1401837  
Aquarius



1401838  
Oceanic



1401839  
Yoredale



603110  
Main Line flax

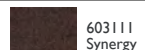

603111  
Synergy

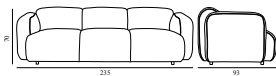

## Swell Sofa 3 Seater

Colli: 1  
 Size & Weight: H: 70 x W: 235 x D: 93 x SH: 42 cm - 63,5 kg  
 Packing: Brown Boxes - Swell 3 Seater is packed on 1 pallet (with 3 boxes): L: 178 x W: 95 x H: 175 cm - 120 kg  
 Material: HR Foam, Plywood, Upholstery; Camira/ Main Line Flax, Synergy, Aquarius, Oceanic, Yoredale. Legs: Painted and Lacquered Ash.  
 Production time: 6 weeks



1401841  
Aquarius



1401842  
Oceanic

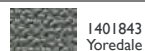

1401843  
Yoredale



603112  
Main Line flax

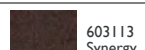

603113  
Synergy

## TABLO

Design: Nicholai Wiig Hansen, 2011

Duty Code: 9403601000

Made in: China

Construction: The Tablo table comes flat packed. The table is quickly and easily assembled without the use of any tools and screws.

Maintenance: Clean with damp cloth. Please be careful with sharp objects and objects made of metal as they may cause scratches on the plastic composite tabletop.

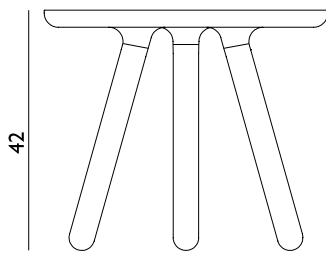

42

50

### Tablo Table Small

Colli: 1  
 Size & Weight: H: 42 x Ø: 50 cm - 4,9 kg  
 Packing: Brown Box - H: 19 x L: 57 x D: 57 cm - 6,5 kg  
 M3: 0,0596  
 Material: Plastic Composite, Ash

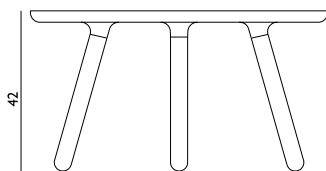
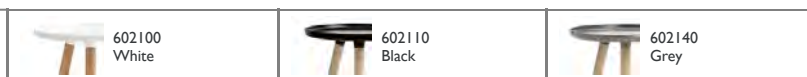

42

78

### Tablo Table Large

Colli: 1  
 Size & Weight: H: 42 x Ø: 78 cm - 11 kg  
 Packing: Brown Box - H: 19 x L: 85 x D: 85 cm - 13,5 kg  
 M3: 0,1341  
 Material: Plastic Composite, Ash



## TAP

Design: Simon Legald, 2014

Awards: German Design Award 2017, Germany

Duty Code: 9401690000

Made in: Denmark

Construction: The seat of the Tap stool is made of a hard PU foam with a closed cell structure for durability and easy maintenance. The Tap Stool comes flat packed. Assembly manual included.

Maintenance: Clean with a damp cloth.

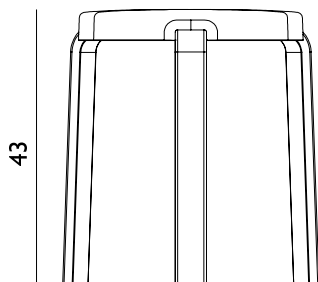

43

41

### Tap Stool Oak

Colli: 1  
 Size & Weight: H: 43 x W: 41 x Ø: 35 cm - 2,5 kg  
 Packing: Brown Box - H: 42,5 x L: 47 x D: 6 cm - 2,8 kg  
 M3: 0,012  
 Material: Seat: PUR Foam, Legs: Lacquered Oak Veneer.  
 Production time: 2 weeks



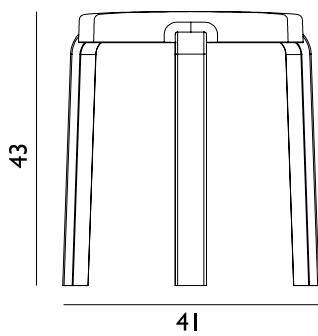

### Tap Stool Walnut

Colli: 1  
 Size & Weight: H: 43 x W: 41 x Ø: 35 cm - 2,5 kg  
 Packing: Brown Box - H: 42,5 x L: 47 x D: 6 cm - 2,8 kg  
 M3: 0,012  
 Material: Seat: PUR Foam, Legs: Lacquered Walnut Veneer.  
 Production time: 2 weeks

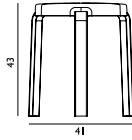

### Tap Stool Black

Colli: 1  
 Size & Weight: H: 43 x W: 41 x Ø: 35 cm - 2,5 kg  
 Packing: Brown Box - H: 42,5 x L: 47 x D: 6 cm - 2,8 kg  
 M3: 0,012  
 Material: Seat: PUR Foam, Legs: Painted and Lacquered Oak Veneer.  
 Production time: 2 weeks



## TIMB CHAIR

Design: Simon Legald, 2020

Duty Code: 9401690000

Made in: Portugal

Construction: The Timb chair comprises a frame of solid painted and lacquered ash and a wide, comfortable seat and backrest made from painted and lacquered ash veneer. The chair has a dowel joint construction with no need for screws. Timb is delivered assembled.

Maintenance: Frame: Clean with damp cloth.

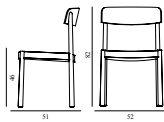

### Timb Chair

Colli: 1  
 Size & Weight: H: 82 x W: 52 x D: 51 x SH: 46 cm - 6,1 kg  
 Packing: Brown Box - H: 85 x L: 63 x D: 62 cm (2 pcs) - 8,5 kg  
 M3: 0,332  
 Material: Frame: Painted and lacquered ash. Seat and back: Painted and lacquered ash veneer.





# TIMB CHAIR UPHOLSTERY

Design: Simon Legald, 2020  
 Duty Code: 9401610000  
 Made in: Portugal

Construction: The Timb chair comprises a frame of solid painted and lacquered ash and a wide, comfortable seat and backrest made from painted and lacquered ash veneer. The chair has a dowel joint construction with no need for screws. Timb is delivered assembled.

Maintenance: Frame: Clean with damp cloth. Leather: Clean with a damp cloth. Use warm water with soap flakes.

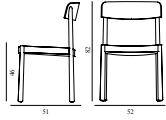

## Timb Chair Upholstery

Colli: 1  
 Size & Weight: H: 82 x W: 52 x D: 51 x SH: 46 cm - 7,5 kg  
 Packing: Brown Box - H: 85 x L: 56 x D: 54 cm - 9,2 kg  
 M3: 0,257  
 Material: Frame: Painted and lacquered ash. Seat and back: Painted and lacquered ash veneer. Upholstery: PU foam and Ultra leather.



1401616  
 Tan /  
 Ultra Leather - Camel



1401617  
 Black /  
 Ultra Leather - Black

# TIMB ARMCHAIR

Design: Simon Legald, 2020  
 Duty Code: 9401690000  
 Made in: Portugal

Construction: The Timb chair comprises a frame of solid painted and lacquered ash and a wide, comfortable seat and backrest made from painted and lacquered ash veneer. The chair has a dowel joint construction with no need for screws. Timb is delivered assembled.

Maintenance: Frame: Clean with damp cloth.

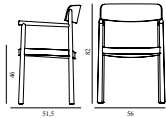

## Timb Armchair

Colli: 1  
 Size & Weight: H: 82 x L: 56 x D: 51,5 x SH: 46 x AH: 68 cm - 6,8 kg  
 Packing: Brown Box - H: 85 x L: 63 x D: 62 cm - 9,2 kg  
 Material: Frame: Painted and lacquered ash. Seat and back: Painted and lacquered ash veneer.



1401618  
 Tan



1401619  
 Black

## TIMB ARMCHAIR UPHOLSTERY

Design: Simon Legald, 2020

Duty Code: 9401610000

Made in: Portugal

Construction: The Timb chair comprises a frame of solid painted and lacquered ash and a wide, comfortable seat and backrest made from painted and lacquered ash veneer. The chair has a dowel joint construction with no need for screws. Timb is delivered assembled.

Maintenance: Frame: Clean with damp cloth. Leather: Clean with a damp cloth. Use warm water with soap flakes.

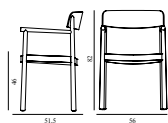

### Timb Armchair Upholstery

Colli: 1  
 Size & Weight: H: 82 x L: 56 x D: 51,5 x SH: 46 x AH: 68 cm - 8,2 kg  
 Packing: Brown Box - H: 85 x L: 63 x D: 62 cm - 10,6 kg  
 M3: 0,332  
 Material: Frame: Painted and lacquered ash. Seat and back: Painted and lacquered ash veneer. Upholstery: PU foam and Ultra leather.



1401620  
Tan /  
Ultra Leather - Camel



1401621  
Black /  
Ultra Leather - Black

## TIMB LOUNGE ARMCHAIR

Design: Simon Legald, 2020

Duty Code: 9401690000

Made in: Portugal

Construction: The Timb lounge armchair comprises a frame of solid painted and lacquered ash and a wide, comfortable seat and backrest made from painted and lacquered ash veneer. The lounge armchair has a dowel joint construction with no need for screws. Timb is delivered assembled.

Maintenance: Frame: Clean with damp cloth.

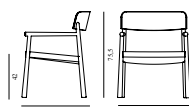

### Timb Lounge Armchair

Colli: 1  
 Size & Weight: H: 75,5 x W: 67 x D: 62 x SH: 42 x AH: 58 cm - 7,2 kg  
 Packing: Brown Box - H: 68 x L: 79 x D: 65 cm - 9,8 kg  
 Material: Frame: Painted and lacquered ash. Seat and backrest: Painted and lacquered ash veneer.



1401904  
Tan



1401905  
Black

# TIMB LOUNGE ARMCHAIR UPHOLSTERY

Design: Simon Legald, 2020  
 Duty Code: 9401610000  
 Made in: Portugal  
 Construction: The Timb lounge armchair comprises a solid painted and lacquered ash frame with slender armrests and a wide, comfortable seat and backrest made from painted and lacquered ash veneer. The lounge armchair has a dowel joint construction with no need for screws. Timb is delivered assembled.  
 Maintenance: Clean with a damp cloth.

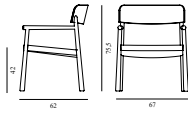



**Timb Lounge Armchair Upholstery**  
 Colli: 1  
 Size & Weight: H: 75,5 x W: 67 x D: 62 x SH: 42 x AH: 58 cm - 7,2 kg  
 Packing: Brown Box - H: 68 x L: 79 x D: 65 cm - 9,8 kg  
 M3: 0,3492  
 Material: Frame: Painted and lacquered ash. Seat and backrest: Painted and lacquered ash veneer. Seat and backrest upholstery: PU foam and Ultra leather by Sørensen Leather.



# TIMB GLIDES

Duty Code: 9401999090  
 Construction: Different types of flooring require different types of glides.  
 Maintenance: We recommend to check the glides every 3-6 months. If worn down, please replace.

Timb Chair & Lounge Chair Glides	
	900277 PS for wood w. felt / Black / 4pcs
	900278 NIPH for wood / Black / 4 pcs

# TOJ

Design: Simon Legald, 2012  
 Duty Code: 9403208000  
 Made in: China  
 Construction: The screws and bolts are accentuated in the design. Easily assembled by following the included manual. Load capacity: 20 kg on the bar and 30 kg on the shelf.  
 Maintenance: Clean with damp cloth.

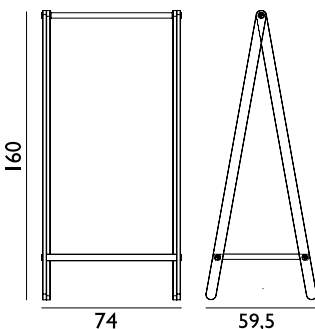

**Toj Clothes Rack Small**  
 Colli: 1  
 Size & Weight: H: 160 x L: 79,5 x D: 59,5 cm - 12 kg  
 Packing: Brown Box - H: 166 x L: 76 x D: 11,5 cm - 16,2 kg  
 M3: 0,1451  
 Material: Steel, Ash



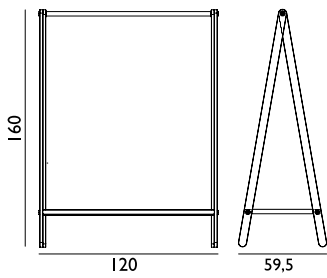

### Toj Clothes Rack Large

Colli: 1  
 Size & Weight: H: 160 x L: 120 x D: 59,5 cm - 16,2 kg  
 Packing: Brown Box - H: 166 x L: 76 x D: 11,5 cm - 19,7 kg  
 M3: 0,1451  
 Material: Steel, Ash



## TURN TABLE

Design: Simon Legald, 2019  
 Duty Code: 9403208000  
 Made in: China

Construction: A spun steel base with metal tubes supports a pressed steel top with embedded veneer board or a marble top. The ash veneer tabletop is lacquered in the same color as the steel base. The marble top matches the steel base in color.

Maintenance: Clean with damp cloth. Please be careful with sharp objects as they may cause scratches on the wooden tabletop. The surface should not be exposed to acidic foods or beverages, which can leave stains on the surface.

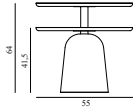

### Turn Table

Colli: 1  
 Size & Weight: H: 41,5 x W: 64 x Ø: 55 cm - 19,5 kg  
 Packing: Brown Box - H: 49 x L: 62,2 x D: 62,2 cm - 23 kg  
 Material: Powder Coated Steel and Painted and Lacquered Ash Veneer

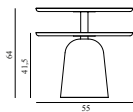

### Turn Table Marble

Colli: 1  
 Size & Weight: H: 41,5 - 64 x Ø: 55 cm - 27,5 kg  
 Packing: Brown Box - H: 49 x L: 62,2 x D: 62,2 cm - 31 kg  
 Material: Powder-coated steel, marble  
 Color: White Marble, Black Marble.



## UNION

Design: Simon Legald, 2018  
 Duty Code: 9403601000  
 Made in: Denmark

Construction: The tabletop is made of particle board with nano-coated laminate for a fingerprint-free surface with higher scratch resistance. Legs are made of powder coated steel with brass fittings. Union comes flat packed and is easily assembled. Assembly manual included.

Maintenance: Clean with a damp cloth. To remove grease (fingerprints etc.) use a glass cleaner

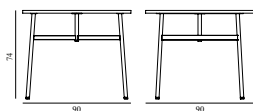

### Union Table 90 x 90 cm

Colli: 1  
 Size & Weight: L: 90 x D: 90 cm  
 Packing: Brown Box - H: 10 x L: 120 x D: 94 cm  
 Material: Tabletop: "Arpa Fenix" high pressure laminate on particle board, Legs: Powder-coated steel  
 Production time: 2 weeks



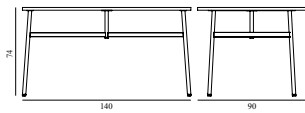

### Union Table 140 x 90 cm

Size & Weight: L: 140 x D: 90 cm  
 Packing: Brown Box - H: 10 x L: 151 x D: 94 cm  
 Material: Tabletop: "Arpa Fenix" high pressure laminate on particle board, Legs: Powder-coated steel  
 Production time: 2 weeks

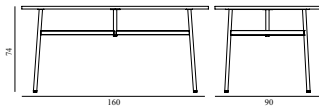
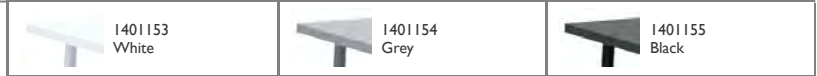

### Union Table 160 x 90 cm

Size & Weight: L: 160 x D: 90 cm  
 Packing: Brown Box - H: 10 x L: 183 x D: 94 cm  
 Material: Tabletop: "Arpa Fenix" high pressure laminate on particle board, Legs: Powder-coated steel  
 Production time: 2 weeks

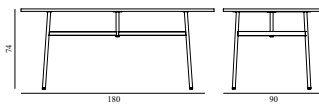
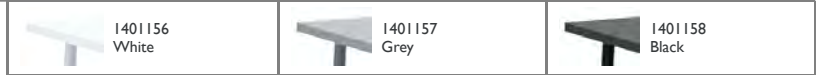

### Union Table 180 x 90 cm

Size & Weight: L: 180 x D: 90 cm  
 Packing: Brown Box - H: 10 x L: 183 x D: 94 cm  
 Material: Tabletop: "Arpa Fenix" high pressure laminate on particle board, Legs: Powder-coated steel  
 Production time: 2 weeks

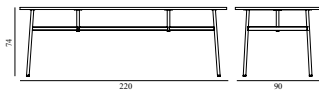

### Union Table 220 x 90 cm

Size & Weight: L: 220 x D: 90 cm - 45 kg  
 Packing: Brown Box - H: 11 x L: 224 x D: 95 cm - 48 kg  
 Material: Tabletop: "Arpa Fenix" high pressure laminate on particle board, Legs: Powder-coated steel  
 Production time: 2 weeks

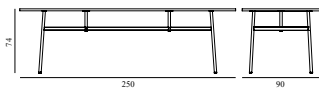

### Union Table 250 x 90 cm

Size & Weight: L: 250 x D: 90 cm  
 Packing: Brown Box - H: 10 x L: 253 x D: 94 cm  
 Material: Tabletop: "Arpa Fenix" high pressure laminate on particle board, Legs: Powder-coated steel  
 Production time: 2 weeks

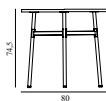

### Union Table Ø80 x H74,5 cm

Colli: 1  
 Size & Weight: H: 74,5 x Ø: 80 cm - 15 kg  
 Packing: Brown Box - H: 14,5 x L: 107,5 x D: 88 cm - 18 kg  
 Material: Tabletop: "Arpa Fenix" high pressure laminate on particle board, Legs: Powder-coated steel  
 Production time: 2 weeks



### Union Table Ø80 x H95,5 cm

Colli: 1  
 Size & Weight: H: 95,5 x Ø: 80 cm - 16 kg  
 Packing: Brown Box - H: 14,5 x L: 107,5 x D: 88 cm - 19 kg  
 Material: Tabletop: "Arpa Fenix" high pressure laminate on particle board, Legs: Powder-coated steel  
 Production time: 2 weeks





### Union Table Ø80 x H105,5 cm

Colli: 1  
 Size & Weight: H: 105,5 x Ø: 80 cm - 16 kg  
 Packing: Brown Box - H: 14,5 x L: 107,5 x D: 88 cm - 19 kg  
 Material: Tabletop: "Arpa Fenix" high pressure laminate on particle board, Legs: Powder-coated steel  
 Production time: 2 weeks

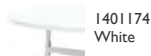

1401174  
White



1401175  
Grey



1401176  
Black

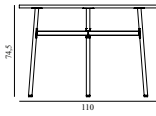

### Union Table Ø110 x H74,5 cm

Size & Weight: H: 74,5 x Ø: 110 cm  
 Packing: Brown Box - H: 14 x L: 122 x D: 122 cm  
 Material: Tabletop: "Arpa Fenix" high pressure laminate on particle board, Legs: Powder-coated steel  
 Production time: 2 weeks



1401177  
White



1401178  
Grey



1401179  
Black

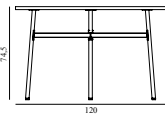

### Union Table Ø120 x H74,5 cm

Colli: 1  
 Size & Weight: H: 74,5 x Ø: 120 cm - 27 kg  
 Packing: Brown Box - H: 14,5 x L: 125 x D: 125 cm - 30 kg  
 Material: Tabletop: "Arpa Fenix" high pressure laminate on particle board, Legs: Powder-coated steel  
 Production time: 2 weeks

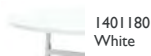

1401180  
White



1401181  
Grey



1401182  
Black

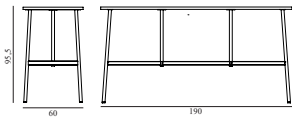

### Union Bar Table 190 x 60 x H95,5 cm

Colli: 1  
 Size & Weight: H: 95,5 x L: 190 x D: 60 cm - 32 kg  
 Packing: Brown Box - H: 11 x L: 224 x D: 94 cm - 37 kg  
 M3: 0,2316  
 Material: Tabletop: "Arpa Fenix" high pressure laminate on particle board, Legs: Powder Coated Steel  
 Production time: 2 weeks



603060  
Black



603061  
Grey



603062  
White

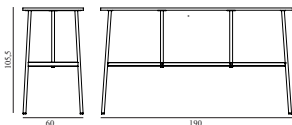

### Union Bar Table 190 x 60 x H105,5 cm

Colli: 1  
 Size & Weight: H: 105,5 x L: 190 x D: 60 cm - 32 kg  
 Packing: Brown Box - H: 11 x L: 224 x D: 94 cm - 37 kg  
 Material: Tabletop: "Arpa Fenix" high pressure laminate on particle board, Legs: Powder Coated Steel  
 Production time: 2 weeks



603063  
Black



603064  
Grey



603065  
White

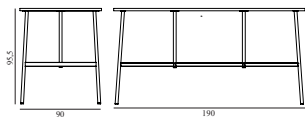

### Union Bar Table 190 x 90 x H95,5 cm

Colli: 1  
 Size & Weight: H: 95,5 x L: 190 x D: 90 cm - 37,5 kg  
 Packing: Brown Box - H: 11 x L: 224 x D: 94 cm - 42,5 kg  
 Material: Tabletop: "Arpa Fenix" high pressure laminate on particle board, Legs: Powder Coated Steel  
 Production time: 2 weeks



603066  
Black



603067  
Grey



603068  
White

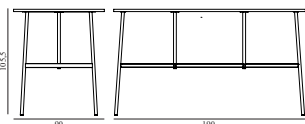

### Union Bar Table 190 x 90 x H105,5 cm

Colli: 1  
 Size & Weight: H: 105,5 x L: 190 x D: 90 cm - 37,5 kg  
 Packing: Brown Box - H: 11 x L: 224 x D: 94 cm - 42,5 kg  
 Material: Tabletop: "Arpa Fenix" high pressure laminate on particle board, Legs: Powder Coated Steel  
 Production time: 2 weeks



603069  
Black



603070  
Grey



603071  
White

# FABRIC SPECIFICATIONS

## CAMIRA - AQUARIUS

Material: 100% Pure New Wool. Non metallic dyestuffs  
Abrasion Resistance:  $\geq 50,000$   
Color Fastness to light: (Scale 1-8, max 8) 4  
Environment: **Indoor Advantage™ "Gold"**

[Read more on camirafabrics.com](http://www.camirafabrics.com)

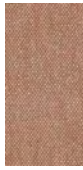

## CAMIRA - MAIN LINE FLAX

Material: 70% Virgin Wool, 30% Flax  
Abrasion Resistance:  $\geq 50,000$   
Color Fastness to light: (Scale 1-8, max 8) 5  
Environment: EU Ecolabel

[Read more on camirafabrics.com](http://www.camirafabrics.com)



## CAMIRA - OCEANIC

Material: 100% post-consumer recycled polyester, including 50% SEAQUAL yarn  
Abrasion Resistance:  $\geq 100,000$   
Color Fastness to light: (Scale 1-8, max 8) 4  
Environment: **OEKO-TEX® Standard 100, Indoor Advantage™ "Gold"**

[Read more on camirafabrics.com](http://www.camirafabrics.com)

## CAMIRA - SYNERGY

Material: 95% Virgin Wool, 5% Polyamide  
Abrasion Resistance:  $\geq 100,000$   
Color Fastness to light: (Scale 1-8, max 8) 5  
Environment: EU Ecolabel

[Read more on camirafabrics.com](http://www.camirafabrics.com)

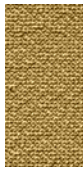

## CAMIRA - YOREDALE

Material: 95% Wool, 3% Polyester, 2% Nylon  
Abrasion Resistance:  $\geq 50,000$   
Color Fastness to light: (Scale 1-8, max 8) 4  
Environment: **Indoor Advantage™ "Gold"**

[Read more on camirafabrics.com](http://www.camirafabrics.com)



## IMATEX - ALBAGIA

Material: 75% cotton, 17% viscose, 8% linnen.  
Abrasion resistance: 30.000 martindale  
Color fastness to rubbing: Wet 4, dry: 4/5  
Color fastness to light: (Scale 1-8, max. 8): 5

[Read more on imatex.it](http://www.imatex.it)

## IMATEX - BOLGHERI

Material: 35% viscose, 26% wool, 17% polyamide, 15% silk, 7% linnen.  
Abrasion resistance: 30.000 martindale  
Color fastness to rubbing: wet 4, dry 4/5  
Color fastness to light: (scale 1-8, max. 8): 5

[Read more on imatex.it](http://www.imatex.it)



## IMATEX - WYNWOOD

Material: 36% acrylic, 27% viscose, 11% polyester, 9% cotton, 8% linen, 6% wool, 2% alpaca wool, 1% silk  
Abrasion resistance: 25.000 martindale  
Color fastness to rubbing: wet 4, dry: 4/5  
Color fastness to light: (Scale 1-8, max. 8): 5

[Read more on imatex.it](http://www.imatex.it)

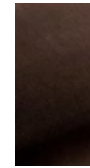

## JAB - CITYVELVET VOL 2

Material: 100% polyester  
Abrasion resistance: 50.000 Martindale  
Color fastness to light: (scale 1-8, max. 8): 3-4

[Read more on jab.de](http://www.jab.de)

## KVADRAT - CANVAS

Composition: 90%, 10% nylon  
Durability: 100.000 Martindale  
Width: 140 cm (approximately 55 inches)  
Yarn type:Worsted  
Binding: Semi-plain Width: (140 cm)  
Weight: Approximately 40'80 g/lin.m  
Repeat: None  
Colour difference may occur

[Read more on kvadrat.dk](http://www.kvadrat.dk)



## KVADRAT - DIVINA

Composition: 100% new wool  
Durability: 45.000 Martindale  
Width: 150 cm (approximately 59 inches)  
Weight: Approximately 840 g/m<sup>2</sup> (27.09 oz/sq ft)  
Repeat: None  
Color difference may occur

[Read more on kvadrat.dk](http://www.kvadrat.dk)



## KVADRAT - DIVINA MD

Composition: 100% new wool  
Durability: 45.000 Martindale  
Width: 150 cm (approximately 59 inches)  
Weight: Approximately 840 g/m<sup>2</sup> (27.09 oz/sq ft)  
Repeat: None  
Color difference may occur

[Read more on kvadrat.dk](http://www.kvadrat.dk)

## KVADRAT - DIVINA MELANGE

Composition: 100% new wool  
Durability: 45.000 Martindale  
Width: 150 cm (approximately 59 inches)  
Weight: Approximately 840 g/m<sup>2</sup> (27.09 oz/sq ft)  
Repeat: None  
Color difference may occur

[Read more on kvadrat.dk](http://www.kvadrat.dk)



## KVADRAT - FIORD

Composition: 90% new wool, worsted 10% nylon  
Durability: 60.000 Martindale  
Width: 140 cm (approximately 55 inches)  
Weight: Approximately 500 g/m<sup>2</sup> (16.13 oz/sq ft)  
Repeat: None  
Color difference may occur

[Read more on kvadrat.dk](http://www.kvadrat.dk)



## KVADRAT - HALLINGDAL

Composition: 70% new wool 30% viscose  
Durability: 100.000 Martindale  
Width: 130 cm (approximately 51 inches)  
Weight: Approximately 795 g/m<sup>2</sup> (25.64 oz/sq ft)  
Repeat: None  
Color difference may occur

[Read more on Kvadrat.dk](http://www.kvadrat.dk)



## KVADRAT - REMIX

Composition: 90% new wool, worsted 10% nylon  
 Durability: 100.000 Martindale  
 Width: 140 cm (approximately 55 inches)  
 Weight: Approximately 420 g/m<sup>2</sup> (13.55 oz/sq ft)  
 Repeat: Approximately 0"/0"  
 Colour difference may occur

Read more on [kvadrat.dk](http://kvadrat.dk)

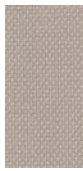

## KVADRAT - STEELCUT TRIO

Composition: 90% new wool, worsted 10% nylon  
 Durability: 100.000 Martindale  
 Width: 140 cm (approximately 55 inches)  
 Weight: Approximately 770 g/m<sup>2</sup> (24.84 oz/sq ft)  
 Repeat: None  
 Color difference may occur

Read more on [kvadrat.dk](http://kvadrat.dk)



## KVADRAT - VIDAR

Durability: 100.000  
 Piling: 4 (ISO 1-5)  
 Lightfastness: 7  
 Fastness to rubbing: 3-4 (dry) 3 (wet)  
 Airflow: 367 Pa s/m  
 Absorption: 0.55/Class D (absorption)

Read more on [kvadrat.dk](http://kvadrat.dk)



## KVADRAT/SAHCO - ELLE

Composition: 25% cotton 20% viscose 20% polyacrylic 20% new wool 15% polyamide  
 Durability: 70.000 Martindale  
 Width: 140 cm (approximately 55 inches)  
 Weight: Approximately 900 g/m<sup>2</sup> (29.03 oz/sq ft)  
 Repeat: None  
 Color difference may occur

Read more on [Kvadrat.dk](http://Kvadrat.dk)



## KVADRAT/SAHCO - ZERO

Composition: 65% cotton 20% polyacrylic 15% polyester  
 Durability: 70.000 Martindale  
 Width:  
 Weight:  
 Repeat: None  
 Color difference may occur

Read more on [Kvadrat.dk](http://Kvadrat.dk)



## SØRENSEN LEATHER - OPTIMO

Material: chrome-free Protected leather  
 Thickness: 1.1 – 1.3 mm  
 Surface: Very strong and durable with a uniform surface grain.  
 Finish: Extremely strong surface protection

Read more on [sorensenleather.com](http://sorensenleather.com)



## SØRENSEN LEATHER - SPECTRUM

Material: Semi-Aniline leather  
 Thickness: 1.0 – 1.2 mm  
 Surface: Matt, smooth surface with a very subtle texture  
 Finish: Light surface protection

Read more on [sorensenleather.com](http://sorensenleather.com)

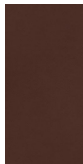

## SØRENSEN LEATHER - ULTRA

Material: Protected leather  
 Thickness: 0.9-1.1 mm  
 Surface: Very strong and durable with a uniform, matt surface print  
 Finish: Extremely strong surface protection

Read more on [sorensenleather.com](http://sorensenleather.com)



## SØRENSEN LEATHER - VEGETAL

Material: Aniline leather  
 Thickness: 1.2 – 1.4 mm  
 Surface: Natural surface with subtle markings  
 Finish: None

Read more on [sorensenleather.com](http://sorensenleather.com)



## SUNBRELLA - CANVAS

Material: 100% Sunbrella Acrylic  
 Surface: Plain-woven fabric  
 Measurements: 54" / 137 cm width  
 Finish: Durable and tightly woven in a plain-weave pattern. Selvedge is Left / Right

Read more on [Sunbrella.com](http://Sunbrella.com)

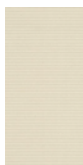

## SWELA - THIRTY-SIX

Material: 100% Polyester  
 Abrasion resistance: 35.000 martindale  
 Color fastness to light: High  
 UV resistant  
 Dirt and water repellent  
 Mold resistant  
 Extremely tear-resistant

Read more on [www.swela.com/en/fabrics](http://www.swela.com/en/fabrics)