

M1

Operator Manual



STARLINE[®]
PROFESSIONAL WASH SYSTEMS



WARNING

Before installation and commissioning, you must read the safety instructions and warnings carefully and all the warning labels attached to the equipment.



IMPORTANT

Failure to comply (even partially) with the instructions given in this manual will invalidate the product warranty and relieves the manufacturer of any responsibility



IMPORTANT

The alteration of machine operation, design or the replacement of parts not approved by the manufacturer may void warranties and approvals.



IMPORTANT

This machine is intended for commercial use only.

CONTENTS

Safety Instructions.....3

Installation.....4

Installation Diagram.....5

Operating Procedures.....6

Troubleshooting.....8

Schematic Diagram.....9

Accessories.....10

We have checked that the contents of this document correspond to the model described. There may be discrepancies nevertheless, and no guarantee can be given that they are completely identical. The information contained in this document is reviewed regularly and any necessary changes will be included in the next edition. We welcome suggestions for improvement.

Specifications and document subject to change without prior notice.

Information supplied in this manual is copyright. No part of this work may be reproduced or copied in any form or by any means, electronic or mechanical without the express permission of the author / publisher.

Service 0800 782 754

Parts 09 829 0930



Manufactured in New Zealand by Washtech Ltd.
414 Rosebank Road, Avondale, Auckland 1026.
PO BOX 90548, Auckland

Safety Instructions



WARNING

Equipment contains dangerous voltages and can be hazardous if installed or operated incorrectly. non-compliance with warnings or failure to follow the instructions contained in this manual can result in loss of life, severe personal injury or serious damage to property.

Installation

- Use qualified, skilled personnel
- Follow installation instructions
- Connect to correct voltage and supply current
- Provide fully accessible electrical Isolation Switch & water supply valves

Training and Supervision

- Read and understand the Operating instructions and train all staff
- This appliance must not be operated by children or infirm persons
- Machine front panel may be removed to access chemical pumps. Access of any further wiring or componentry must only be done by suitably qualified and trained personnel – internal hazards include live electrics and very hot surfaces
- This appliance is not intended for use as a stepladder

Hot Surfaces

- Some surfaces may be hot or very hot

Chemicals

- Commercial dishwashing detergents are hazardous – handle with care
- Read and follow the safety information found on the labels of detergent containers and Material Safety Data Sheets
- Use protective eyewear and clothing if decanting containers

Hot Water

- Do not put hands in wash water which may be over 60°C and contain hazardous caustic detergent
- Rinse water can be over 90°C
- Door safety switches are designed for emergency use only

Cleaning

- Do not hose down the machine or splash water over the exterior
- Watch for broken glass etc when cleaning the inside of the machine

Service/repair

- Under no circumstances the user should attempt to carry out repairs
- All service/repair work must be carried out by qualified personnel only

Power Cord Replacement

- If the supply cord is damaged, it must be replaced by the manufacturer or its service agent or a similar qualified person in order to avoid a hazard

Installation Checklist



WARNING

Installer must be suitably qualified and ensure compliance with all codes and standards including AS/NZS3500.1.

Unpack

- Unpack the machine, check for damage and complete delivery.

Positioning

- Place machine on sound waterproof self draining floor, fit feet and adjust feet to level
- Allow room for adjacent chemical containers

Water

- Flush supply lines before connection
- Connect hose supplied to adjacent accessible isolator valve - 20 mm 3/4 male
- Flow rate required - 20 litres per minute
- Temperature - 65°C
- Consumption per cycle - 2.6 litres
- Pressure required - 200-350 kPa - fit limiter above this pressure
- Back Flow - Atmospheric Vacuum Breaker
- Potable water quality is required - filter or soften if necessary

Water Quality Requirements

Hardness	ppm		pH			
min	20		7			
max	100		8			
Ions	Cl ⁻	SO ₄	Fe	Mn	Cu	Cl ₂
Max mg/L	100	400	0.1	0.5	0.05	0.1

Power

- Machine shipped with cordset for 15 A 230V 50Hz via adjacent switched outlet

Waste

- Connect drain pump hose supplied to upstand or sink waste connection

Detergent

- Note that detergent is hazardous - read instructions and handle with care
- Insert hose into container of commercial dishwasher low foam detergent
- Detergent will come up to strength with use during the day

Rinse Fluid

- Insert hose into adjacent container of commercial dishwasher rinse fluid

Operation

- Run several cycles, ensure that operator has read and understands instructions

Troubleshooting Installation

- If machine doesn't fill after switching on power, check & ensure that hot water supply tap is open, water supply pressure is not below specification

M1 Installation Diagram

M1 INST 25-07-17 3 B

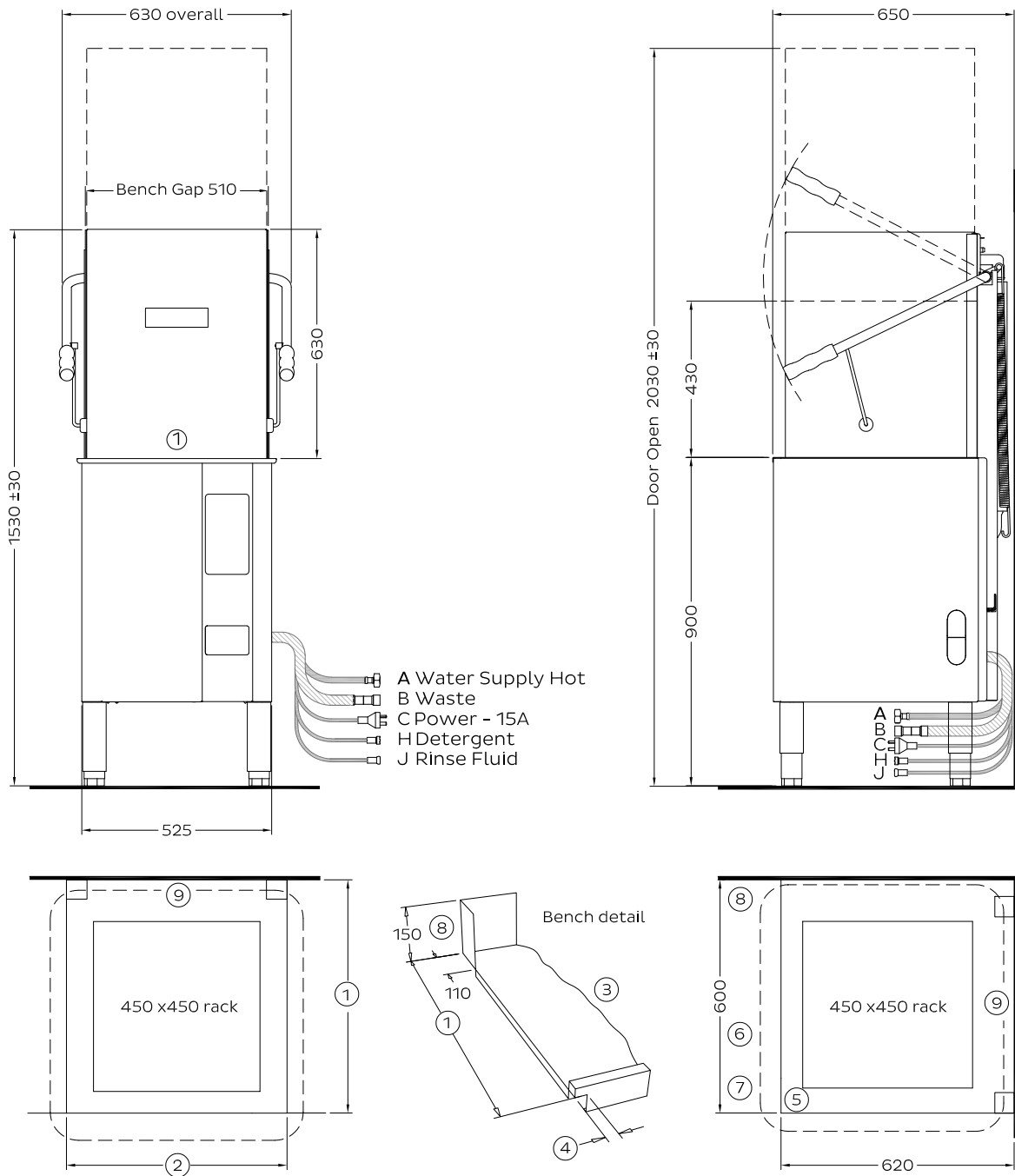

In-line Installation

- ① Minimum Depth 600
- ② Bench gap 510
- ③ left side is mirror image
- ④ Notch 25

Corner Installation

- ⑤ wall to front inside corner
- ⑥ machine must face left for controls access
- ⑦ allow 300 clearance to front for service access
- ⑧ splashback return no higher than 150
- ⑨ No obstruction behind machine

M1 Operating Instructions

Start

- Ensure the Upstand (1) is fitted and shut the door
- Turn wall power switch on and select any cycle (1, 2, or 3)
- Power light glows red and machine fills automatically
- Once full, rinse heating starts

Operation

- Select required cycle of 1, 2 or 3 minutes
- Load rack into machine and shut door
- Cycle light glows green while machine operates
- When the Cycle light goes out, the cycle is complete.

NOTE: Machine may be started while the rinse water is being heated - in this instance it will continue to run the wash cycle until the rinse water is up to 83 degrees

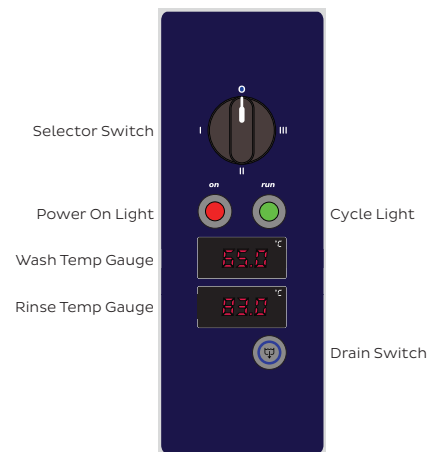

Detergent & Rinse Aid

- Detergent dosing can be increased/decreased via the adjusting screw on the front cover.
- Rinse Aid dosing is factory set to a low injection rate, and will take many cycles to prime. The operator can adjust this via the adjusting screw on the front cover.

Shut Down - Every Night

- Remove Upstand (1)
- Turn drain switch on to drain wash tank
- Allow to drain for approximately 1 minute or until tank is empty
- Turn drain and power switches off
- Turn Cycle Selector to 0 and turn off the power from the wall
- Remove and rinse wash filter (2) before replacing back in machine along with upstand (1)

Cleaning - At Least Once A Week

Remove, rinse and replace:

Upstand	1
Wash Filter	2
Wash/Rinse Arms	3
Thumbscrews	4

Inspect and clear all jets in the wash/rinse arm

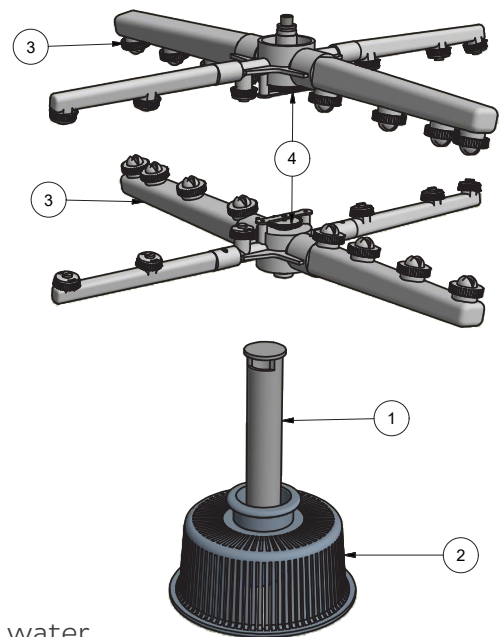

Suggested Best Practice

- | | |
|-----------|--|
| Pre-rinse | Scrape and/or rinse plates & glasses in cool water |
| Chemical | Use good quality non foaming commercial detergent and drying agent. Do not use domestic detergent which will cause the machine to foam |

Troubleshooting

Fault	Cause	Remedy
Filling		
Not filling	Water supply valve shut	Check Water supply valve
Filling during wash cycle	Door Switch not operating	Check Door is closed
	Upstand not fitted properly	Check Drain upstand is fitted
Heating		
Dishes not hot enough	Machine not rinsing	Check water supply temperature
	Rinsing but not hot	Check water supply temperature & arms spinning freely
Cycle start		
Does not start	Door switch	Check door is closed
Cycle Finish		
Wash too long	Water supply cold	Check water supply temperature
Performance		
Poor wash result	Detergent not used	Use quality low foam product
	Overloading racks	Do not overload racks
	Not pre-rinsing	Use Fisher pre-rinse
	Wash arms not rotating	Remove and clean arms/check bushes
	Wash jets blocked	Remove arms and clean jets
	Excessive soiling	Pre-rinse/use long cycle
Poor rinse results	Unrealistic expectation	E.g. baked on soiling requires pre-soaking
	Rinse jets blocked	Remove arms and clean jets
	Rinse arms not turning	Remove arms, clean jets, check bushes
	Poor racking procedures Excessive wash tank soil build up	Do not overload racks Pre-rinse, change wash water regularly
Not drying	Poor wash/rinse performance	Refer above
	Low temperatures	Check heating systems
	Drying agent not used	Use quality drying agent/rinse fluid
Foaming Wash	Excessive Rinse Fluid	Adjust Rinse Fluid Injector

Accessories

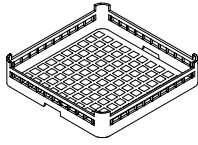

600 70080
CUPRACK 450mm PLASTIC

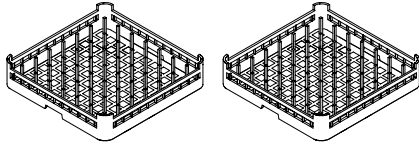

600 70081
DISHRACK 450mm PLASTIC

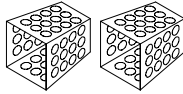

C660503
CUTLERY CONTAINER G



600 60080
HOSE SS 2M

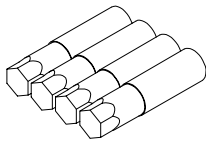

600 90154
SS LEG 63D x 225 - 325mm x M12

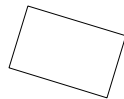

WIRING DIAGRAM

(UNDER
FRONT
COVER)

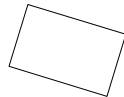

OPERATOR MANUAL

Notes

Notes

Information supplied in this manual is copyright.
No part of this work may be reproduced or copied
in any form or by any means, electronic or
mechanical without the express permission of the
author/publisher

Manufactured in New Zealand by Washtech Ltd.

WASHTECH

414 Rosebank Road
Avondale
Auckland 1026
New Zealand

PO Box 90548, Auckland

24HR Service 0800 Starline
Tel 09 829 0930
Fax 09 829 0935
E-mail info@washtech.co.nz
web www.starline.co.nz

ISO9001

All Washtech products are designed and
manufactured by Washtech using the
internationally recognised ISO9001 quality
management system, covering design,
manufacture and final inspection, ensuring
consistent high quality at all times.

In line with policy to continually develop and
improve its products, Washtech Ltd reserves the
right to change specifications and design without
prior notice.

an Ali Group Company



The Spirit of Excellence