

|                      |       |                     |                  |           |
|----------------------|-------|---------------------|------------------|-----------|
| Customer/Wholesaler: | Date: | Job Name:           | Model Specified: | Quantity: |
| Contractor:          |       | Architect/Engineer: |                  |           |

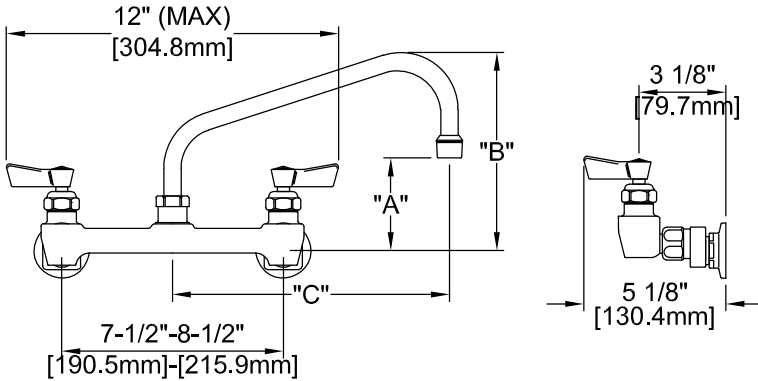

- MODEL:**
- 3250 FAUCET 8AWLH 06SS
  - 3251 FAUCET 8AWLH 08SS
  - 3252 FAUCET 8AWLH 10SS
  - 3253 FAUCET 8AWLH 12SS
  - 3254 FAUCET 8AWLH 14SS
  - 9102 FAUCET 8AWLH 16SS

- OPTIONS OR MODIFICATIONS:**
- OTHER \_\_\_\_\_

- FEATURES:**
- \* 8" ADJUSTABLE WALL MOUNT
  - \* ECCENTRICS ADJUST FROM 7-1/2" TO 8-1/2"
  - \* SWIVELING SEAT DISKS
  - \* HOT SIDE STEM - RIGHT HAND
  - \* COLD SIDE STEM - LEFT HAND
  - \* STAINLESS STEEL SEATS
  - \* STAINLESS STEEL SEAT SCREWS
  - \* STAINLESS STEEL HANDLE SCREWS

| MODEL | DIM "A"             | DIM "B"             | DIM "C"          |
|-------|---------------------|---------------------|------------------|
| 3250  | 2-1/4"<br>[57.2mm]  | 5-7/8"<br>[149.2mm] | 6"<br>[152.4mm]  |
| 3251  | 2-1/2"<br>[63.5mm]  | 6-3/8"<br>[161.9mm] | 8"<br>[203.2mm]  |
| 3252  | 3-1/8"<br>[79.4mm]  | 6-7/8"<br>[174.6mm] | 10"<br>[254.0mm] |
| 3253  | 3-3/4"<br>[95.3mm]  | 7-3/8"<br>[187.3mm] | 12"<br>[304.8mm] |
| 3254  | 4-3/8"<br>[111.1mm] | 8-1/4"<br>[209.6mm] | 14"<br>[355.6mm] |
| 9102  | 5"<br>[127.0mm]     | 8-7/8"<br>[225.4mm] | 16"<br>[406.4mm] |

- SYSTEM LIMITS**
- \* TEMP: 40°F MIN. TO 160°F MAX.
  - \* PRESSURE 200 PSI MAX. STATIC
  - \* 2.20 GPM AT 60 PSI (8.3 L/min @410 KPa)

- SHIPPING WEIGHT**
- \* 5.0 LBS





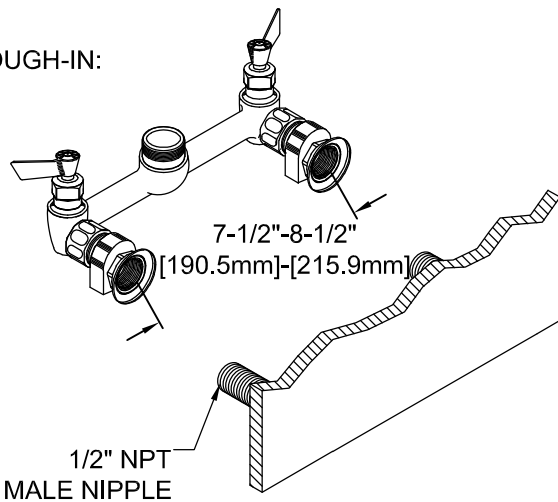

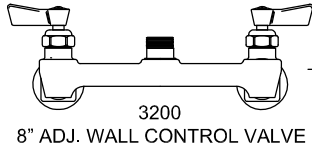

- PRODUCT COMPLIANCE:**
- \* ASME A112.18.1 / CSA B125.1
  - \* NSF 61 - Section 9
  - \* NSF 372 (Low Lead Content)

**ROUGH-IN:**



## Replacement Parts for Wall Mount Faucets

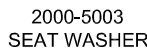
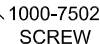

-  2000-7500 SCREW
-  2000-8000 RED BUTTON AND 2000-8001 BLUE BUTTON
-  LEVER HANDLE
-  2000-3002 BIBB CAP
-  73657 DUCK GASKET
-  2000-5000 WASHER
-  3000-0010 LH SWIVEL STEM OR 3000-0011 RH SWIVEL STEM
-  2000-5003 SEAT WASHER
-  1000-7502 SCREW
-  73521 LUBE

3967  
16" SWING SPOUT

3964  
14" SWING SPOUT

3963  
12" SWING SPOUT

3962  
10" SWING SPOUT

3961  
8" SWING SPOUT

3960  
6" SWING SPOUT

2000-0002  
LEVER HANDLE KIT

3000-0000  
RH SWIVEL STEM  
REPAIR KIT  
OR  
3000-0001  
LH SWIVEL STEM  
REPAIR KIT

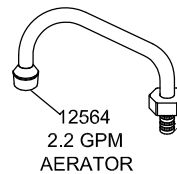

73684  
SPOUT NUT

20020  
SNAP RING

1600-5000  
SPOUT  
O-RING

73521  
LUBE

19119  
SWIVEL SPOUT  
RETRO-FIT KIT



3200-2306  
ECCENTRIC  
FLANGES



3200-2307  
1/2" ECCENTRICS



2200-5000  
ECCENTRIC GASKETS