

MOMIC by Rafa García, 2022

EXPLICACION DEL MODELO

Modern Mid-Century

Como su nombre indica, **Momic** de **Rafa García**, es la reinterpretación del clásico sofá de los años cincuenta (Mid-Century) adaptado a un estilo de vida actual. Líneas delicadas, curvas suaves y formas orgánicas dan lugar a una familia de asientos de elegante sencillez y estética atemporal. Estilo moderno para interiores contemporáneos y dinámicos.

Momic se compone de un amplio programa modular. Dos medidas de asiento son el punto de partida para dar forma a sofás de 2 y 3 plazas, módulos con y sin brazo, varias opciones de chaise longue, un puf, terminales y una pieza con un ángulo de 45° para generar todo tipo de composiciones. Un diseño que se adapta tanto a pequeños espacios como a amplias plantas abiertas.

Sus dimensiones son contenidas; su estructura aérea le confiere un aspecto liviano; las almohadas están sueltas y las costuras en el respaldo aportan un toque sutil y distintivo. Las almohadas de respaldo incorporan un refuerzo de espuma, para que se mantengan erguidas cuando nos sentamos.

Paralelamente, sus robustas patas de madera de fresno quedan vistas adquiriendo protagonismo al enmarcar las sinuosas líneas de los brazos. Éstas son además un elemento distintivo porque se pueden personalizar en todos los colores de tintes de nuestra carta.

La estética Mid-Century es bien conocida por hacer uso de colores vibrantes, aunque contrastados con tonos más neutros y calmados. Así es también la amplia oferta textil en la que puede tapizarse **Momic**.

Todos estos detalles hacen de **Momic** una pieza completamente actual. Un diseño que deseamos se convierta en un clásico de nuestro catálogo. Y que pueda convertirse en un objeto que pase de generación en generación.

DESCRIPTION

Modern Mid-Century

As its name suggests, **Momic** by **Rafa García** is the reinterpretation of the classic shapes of 50s sofa aesthetics (Mid-Century) for a modern lifestyle. Delicate lines, soft curves and organic shapes create a seating family of elegant simplicity and timeless appearance. Modern flair for contemporary, dynamic interiors.

Momic includes an extensive modular programme. Two seat sizes are the starting point to create 2 and 3-seater sofas, modules with or without armrests, a variety of chaise longue possibilities, a pouf, terminal pieces and a 45° angled module to give shape to all kinds of compositions. A design that adapts to both small spaces and large open-plan layouts.

Its dimensions are moderate; its light structure gives it an airy appearance; the loose cushions and their stitching on the backrest provides a subtle, distinctive detail. The back cushions are reinforced with foam, so they remain firm when sitting down.

The sturdy ash wood legs take centre stage, available in any of our stains, they frame the sinuous lines of the armrests.

The Mid-Century aesthetic is well known for its use of vibrant colours, contrasted with neutral tones, easy to replicate with the wide range of fabrics in which **Momic** can be upholstered.

All these details make **Momic** a contemporary piece. A design that we hope will become a classic in our catalogue, to be passed down from generation to generation.

FIRMEZA / FIRMNESS / FERMETÉ

SUAVE	<input type="checkbox"/>	FIRME
SOFT	<input type="checkbox"/>	FIRM
DOUX	<input type="checkbox"/>	FERME

MOMIC by Rafa García, 2022**IMPORTANTE**

Las solicitudes de composiciones modulares deben adjuntar un plano en planta al realizar el pedido. La mano (derecha/izquierda) se interpreta siempre viendo el dibujo de frente.

La unión de los módulos se realiza mediante carracas.

Previa solicitud, los sofás y módulos de 3 almohadas se pueden fabricar para que sean desmontables en destino (especificar en pedido). Adjuntamos instrucciones de montaje y desmontaje.

Disponible en vinilos u otras pieles sintéticas, pero no admite barrera ignifuga en estos casos.

Especifique en el pedido el color deseado para las patas (ver muestras de tintes para el fresno). Requieren montaje e incorporan instrucciones.

Servicio RAL disponible para este producto. Por favor, consulta el apartado "Colores RAL" en la sección de "Acabados".

IMPORTANT

Please provide a plan with ordering. Left and right are taken to be as facing the piece.

The modules are joined by a ratchet system.

At the customer's request, sofas and modules with 3 cushions, can also be manufactured in the same way (please indicate this on the order) and will include disassembly and assembly instructions.

This product is available in vinyl or synthetic leather, but in these upholstered options cannot have an interliner fitted.

Choose a stain colour for the solid ash legs from the chart at the of the price list. Attach them as per the instructions supplied with the product.

Match to RAL service available for this product. Please consult the "RAL Colours" in the "Finishes" section.

CARACTERISTICAS TECNICAS**TELA Y PIEL**

- Estructura y almohadas totalmente desenfundables.
- Estructura de madera, forrada en espuma de densidad diferenciada (CMHR 30kg/25kg y 40CMX) y fibra de 100gr con velour.
- Bastidor de asiento preparado con cinchas NEA de 80mm.
- Bastidor de brazo y respaldo: estructura de madera de pino y tablex. Confeccionado en espuma de densidad diferenciada (CMHR 30kg/25kg y 40CMX).
- Almohada de asiento: espuma 40CMX y CMHR25 kg (composición de 2 densidades de espuma para la almohada) recubierta de fibra poliéster H150 y funda interior de tela.
- Almohada de respaldo: funda de algodón rellenas de FiberDream con refuerzo interno de espuma CMHR 40kg.
- Patas: madera de fresno maciza acabado en los tintes de nuestra carta.
- Pata central en sofás a partir de 2 m. de longitud y módulos a partir de 1,9 m.: acero F1 color negro regulable en altura.

TECHNICAL SPECIFICATIONS**FABRIC AND LEATHER**

- Totally removable base and cushion covers.
- Wooden structure covered with foam of varying densities (CMHR 30kg/25kg, 40CMX) and H100g fibre.
- Seat structure fitted with 80mm NEA webbing.
- Back and arm wooden structure covered with multilayered foam (CMHR 30kg/25kg and 40CMX).
- Seat cushion: 40CMX and CMHR25kg foam (composed of 2 different densities of foam for front and sides) covered with H150 thermofused polyester fibre and fabric inner cushion cover.
- Back cushion: cotton cover filled with FiberDream and CMHR40kg foam core.
- Legs: solid ash stained.
- Adjustable central foot: black F1 steel in the sofas from 2m length as well as modules from 1.9m.

ACABADOS / FINISHES / FINITIONS**PATAS / LEGS / PIED**

FRESNO / ASH / FRÊNE
TINTES / STAINS / TEINTES



Ejemplos de composición / Composition examples

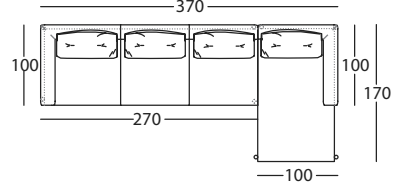
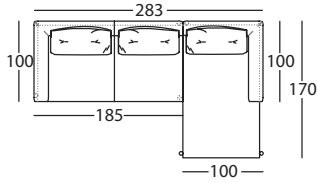

Ref: 359.122.U.I 359.142.T.D

359.122.Z4.I 359.142.T.D

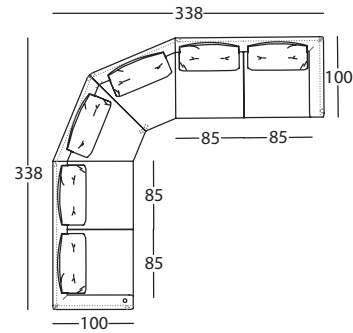
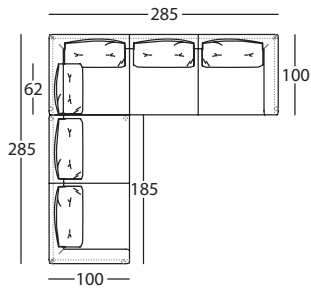

Ref: 359.11.Z5 + 359.26

359.16.Z6.BR.I 359.16.Z6.BR.D

359.122.U.I

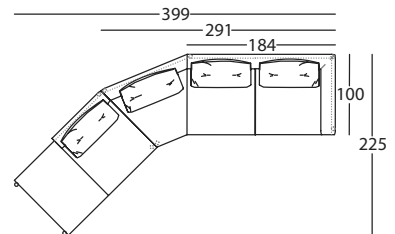
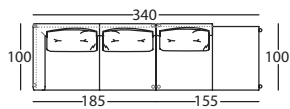

Ref: 359.121.U.I 359.17.RL.D

359.17.RL.I 359.16.Z6.BR.D

MOMIC by Rafa García, 2022

Módulos / Modules

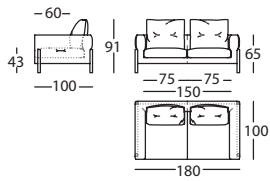

359.11.U

MOMIC SOFA 180
MOMIC SOFA 180
MOMIC CANAPE 180

1,02 m³ / 1 Pack. / 65,8 kg

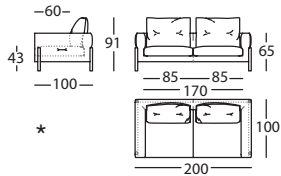

359.11.W

MOMIC SOFA 200
MOMIC SOFA 200
MOMIC CANAPE 200

1,13 m³ / 1 Pack. / 70,3 kg

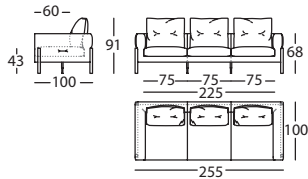

359.11.Z2

MOMIC SOFA 255
MOMIC SOFA 255
MOMIC CANAPE 255

1,44 m³ / 1 Pack. / 89,8 kg

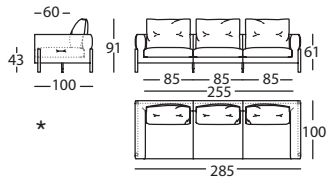

359.11.Z5

MOMIC SOFA 285
MOMIC SOFA 285
MOMIC CANAPE 285

1,6 m³ / 1 Pack. / 94,6 kg

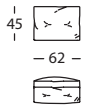

359.26

MOMIC COJIN ANGULO
MOMIC CORNER CUSHION
MOMIC COUSSIN ANGLE

0 m³ / 1 Pack. / 4 kg

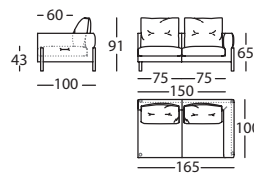

359.122.S.D

MOMIC MOD 165 BRAZO DCHO
MOMIC MOD 165 RIGHT ARM
MOMIC MOD 165 BRAS DROIT

0,94 m³ / 1 Pack. / 57,4 kg

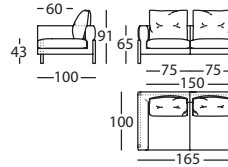

359.122.S.I

MOMIC MOD 165 BRAZO IZDO
MOMIC MOD 165 LEFT ARM
MOMIC MOD 165 BRAS GAUCHE

0,94 m³ / 1 Pack. / 57,4 kg

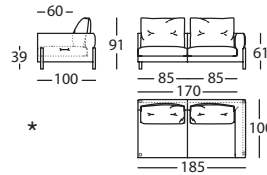

359.122.U.D

MOMIC MOD 185 BRAZO DCHO
MOMIC MOD 185 RIGHT ARM
MOMIC MOD 185 BRAS DROIT

1,05 m³ / 1 Pack. / 60,4 kg

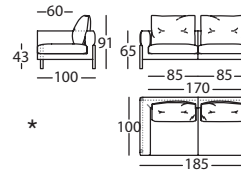

359.122.U.I

MOMIC MOD 185 BRAZO IZDO
MOMIC MOD 185 LEFT ARM
MOMIC MOD 185 BRAS GAUCHE

1,05 m³ / 1 Pack. / 60,4 kg

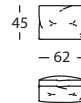

359.26

MOMIC COJIN ANGULO
MOMIC CORNER CUSHION
MOMIC COUSSIN ANGLE

0 m³ / 1 Pack. / 4 kg

* Puede formar ángulo con almohada respaldo ref. 359.26
Can create angle with cushion ref. 359.26

MOMIC by Rafa García, 2022

Módulos / Modules

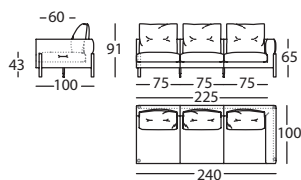

359.122.Z1.D

MOMIC MOD 240 BRAZO DCHO
MOMIC MOD 240 RIGHT ARM
MOMIC MOD 240 BRAS DROIT

1,35 m³ / 1 Pack. / 81,4 kg

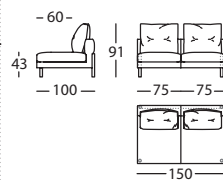

359.121.R

MOMIC MODULO 150
MOMIC MODULE 150
MOMIC MODULE 150

0,85 m³ / 1 Pack. / 49 kg

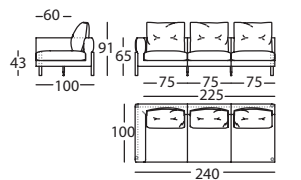

359.122.Z1.I

MOMIC MOD 240 BRAZO IZDO
MOMIC MOD 240 LEFT ARM
MOMIC MOD 240 BRAS GAUCHE

1,35 m³ / 1 Pack. / 81,4 kg

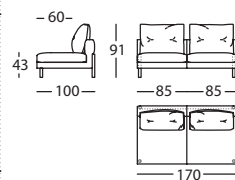

359.121.T

MOMIC MODULO 170
MOMIC MODULE 170
MOMIC MODULE 170

0,96 m³ / 1 Pack. / 52,5 kg

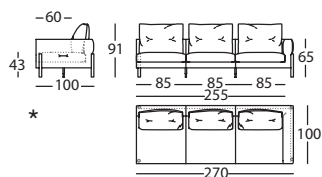

359.122.Z4.D

MOMIC MOD 270 BRAZO DCHO
MOMIC MOD 270 RIGHT ARM
MOMIC MOD 270 BRAS DROIT

1,52 m³ / 1 Pack. / 86,2 kg

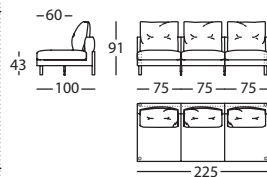

359.121.Y

MOMIC MODULO 225
MOMIC MODULE 225
MOMIC MODULE 225

1,27 m³ / 1 Pack. / 73 kg

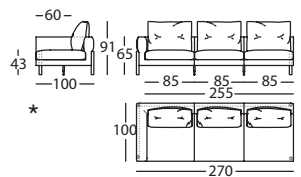

359.122.Z4.I

MOMIC MOD 270 BRAZO IZDO
MOMIC MOD 270 LEFT ARM
MOMIC MOD 270 BRAS GAUCHE

1,52 m³ / 1 Pack. / 86,2 kg

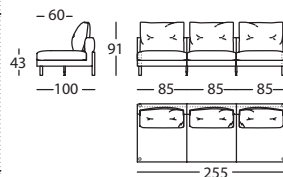

359.121.Z2

MOMIC MODULO 255
MOMIC MODULE 255
MOMIC MODULE 255

1,44 m³ / 1 Pack. / 77,8 kg

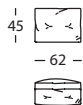

359.26

MOMIC COJIN ANGULO
MOMIC CORNER CUSHION
MOMIC COUSSIN ANGLE

0 m³ / 1 Pack. / 4 kg

* Puede formar ángulo con almohada respaldo ref. 359.26
Can create angle with cushion ref. 359.26

MOMIC by Rafa García, 2022

Chaise / Chaise longue

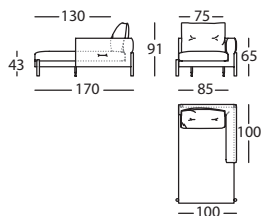

359.142.T.D

MOMIC CHAISE 170 BRAZO DCHO
MOMIC CHAISE LONGUE 170 RIGHT ARM
MOMIC CHAISE LONGUE 170 BRAS DROIT

0,96 m³ / 1 Pack. / 50,5 kg

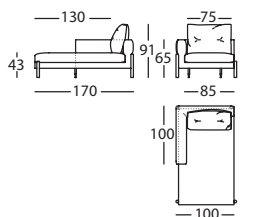

359.142.T.I

MOMIC CHAISE 170 BRAZO IZDO
MOMIC CHAISE LONGUE 170 LEFT ARM
MOMIC CHAISE LONGUE 170 BRAS GAUCHE

0,96 m³ / 1 Pack. / 50,5 kg

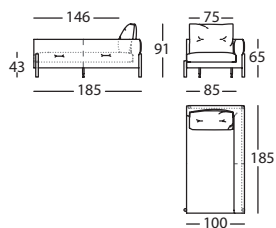

359.142.U.D

MOMIC CHAISE 185 BRAZO DCHO
MOMIC CHAISE LONGUE 185 RIGHT ARM
MOMIC CHAISE LONGUE 185 BRAS DROIT

1,05 m³ / 1 Pack. / 55,9 kg

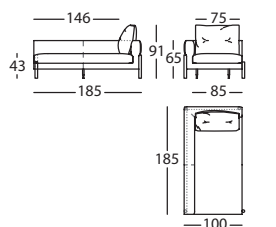

359.142.U.I

MOMIC CHAISE 185 BRAZO IZDO
MOMIC CHAISE LONGUE 185 LEFT ARM
MOMIC CHAISE LONGUE 185 BRAS GAUCHE

1,05 m³ / 1 Pack. / 55,9 kg

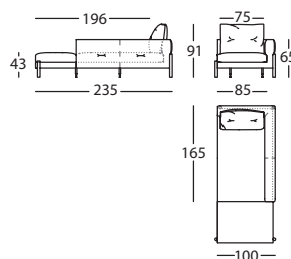

359.142.Z.D

MOMIC CHAISE 235 BRAZO DCHO
MOMIC CHAISE LONGUE 235 RIGHT ARM
MOMIC CHAISE LONGUE 235 BRAS DROIT

1,33 m³ / 1 Pack. / 70,3 kg

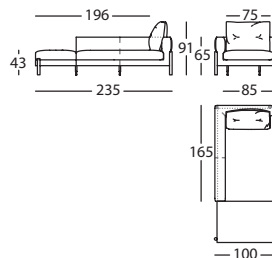

359.142.Z.I

MOMIC CHAISE 235 BRAZO IZDO
MOMIC CHAISE LONGUE 235 LEFT ARM
MOMIC CHAISE LONGUE 235 BRAS GAUCHE

1,33 m³ / 1 Pack. / 70,3 kg

Puf / Pouf

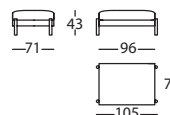

359.152.LH

MOMIC PUF 104X72
MOMIC POUF 104X72
MOMIC POUF 104X72

0,26 m³ / 1 Pack. / 16,4 kg

Ángulo / Corner / Angle

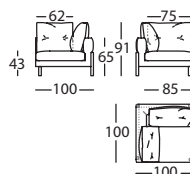

359.161

MOMIC ANGULO RECTO 100X100
MOMIC S. CORNER 100X100
MOMIC ANGLE 100X100

0 m³ / 1 Pack. / 40,6 kg

MOMIC by Rafa García, 2022

Módulo terminal / Terminal module

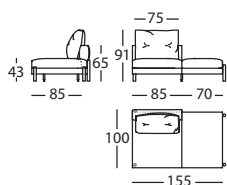

359.17.RL.D

MOMIC MOD TERMINAL 155 DCHO
MOMIC MOD 155 RIGHT TERMINAL
MOMIC MOD TERMINAL 155 DROIT

0,88 m³ / 1 Pack. / 43,1 kg

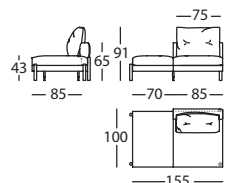

359.17.RL.I

MOMIC MOD TERMINAL 155 IZDO
MOMIC MOD 155 LEFT TERMINAL
MOMIC MOD TERMINAL 155 GAUCHE

0,88 m³ / 1 Pack. / 43,1 kg

Módulo ángulo / Corner Module

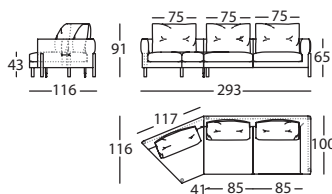

359.16.Z6.BR.D

MOMIC MOD ANGULO 293 BRAZO DCHO
MOMIC CORNER MODULE 293 RIGHT ARM
MOMIC ANGLE MODULE 293 BRAS DROIT

1,65 m³ / 1 Pack. / 86,3 kg

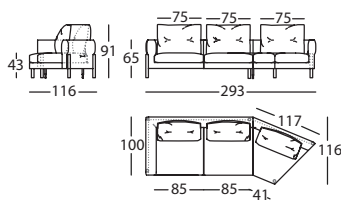

359.16.Z6.BR.I

MOMIC MOD ANGULO 293 BRAZO IZDO
MOMIC CORNER MODULE 293 LEFT ARM
MOMIC ANGLE MODULE 293 BRAS GAUCHE

1,65 m³ / 1 Pack. / 86,3 kg