

IMPOSSIBLE A 85 PENDANT

Designed by Massimo Mussapi

DESIGN & INSPIRATION

Impossible is the new collection designed by architect Massimo Mussapi. It consists of different models in large formats that can be used individually and in groups for spectacular arrangements. The delicate Venetian-style light effect is echoed by graceful and virtuoso textures, smooth and light silhouettes, magically suspended like bright clouds between sky and earth.

LIGHT SOURCE



1 x E26 LED 15W MAX
Suggested Specs: A19 Frosted
> 90 CRI / 3000K / Dimmable

SPECIFICATIONS & TECHNICAL NOTES

UL Listed

Made in Italy. Constructed in metal

Mounts directly to a standard Junction box

Cable length max. 10' (field adjustable)

Custom colors available upon request

PRODUCT CODES



Matt White

ML-240.085.02E



Black

ML-240.085.03E



Bronze

ML-240.085.04E



Satin Gold

ML-240.085.05E



DIAGRAM

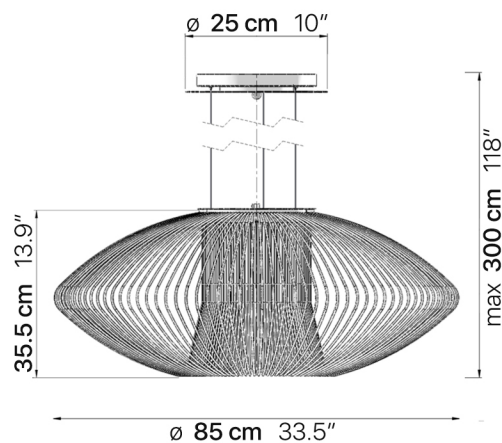

uplight group.

Uplight Group, LLC 1835 NE Miami Gardens Dr. N. Miami Beach, FL 33179
Tel. +1.305.621.9602 sales@uplightgroup.com www.uplightgroup.com

Fixture Type _____ Notes _____
Project Name _____

METAL LUX

