

**DOMINO
CLAMPS™**

Container Clamps Ltd
T/A Domino Clamps
6th Floor
111 Charterhouse St
London EC1M 6AW
www.dominoclamps.com
00 44 208 1234 121

Full Guide - How to Frame A Shipping Container

These instructions are meant for guidance only and depending on the condition of your container and personal preference may need to be adapted to suit your needs.

This guide contains a method of framing three sides of a shipping container using Domino Clamps, which will leave your shipping container completely undamaged!

[Watch our full Cladding-Video on YouTube](#)

[Click here to buy the Domino Clamp](#)

You might also like our related articles:



[How to Clad a Shipping Container - A complete guide](#)



[How to Frame a Shipping Container: Timber, Steel, Unistrut or Scaffold](#)



[Introducing our new Range of Shipping Container Brackets](#)

Equipment:

(12x) [Domino Clamps](#)

(12x) [Domino Plywood Adapters](#)

Hex Key

Tape Measure

Pencil

Hand Saw/Circular Saw

Drill and Driver

Materials:

8"x2" C24 Timber

4"x2" CLS Studwork Timber or Similar

Pilot Drill bit (4mm)

(5x) 90mm Screws

70mm Wood screws

90mm Screws

1. Prepare your container

Before you start: Ensure your container is well sited on a flat, solid surface.

1. Attach a Domino Clamp to each corner of each face of the shipping container to be clad (two sides and one end).

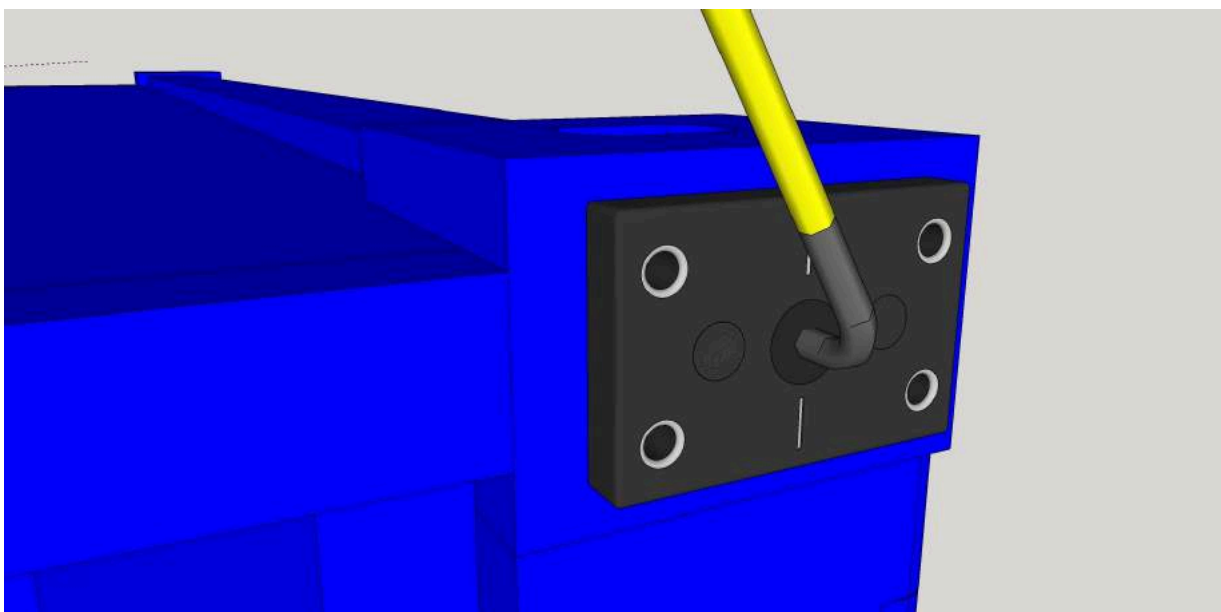

2. Attach a Domino Plywood Adapter to each Domino Clamp using the 45mm countersunk bolts provided.

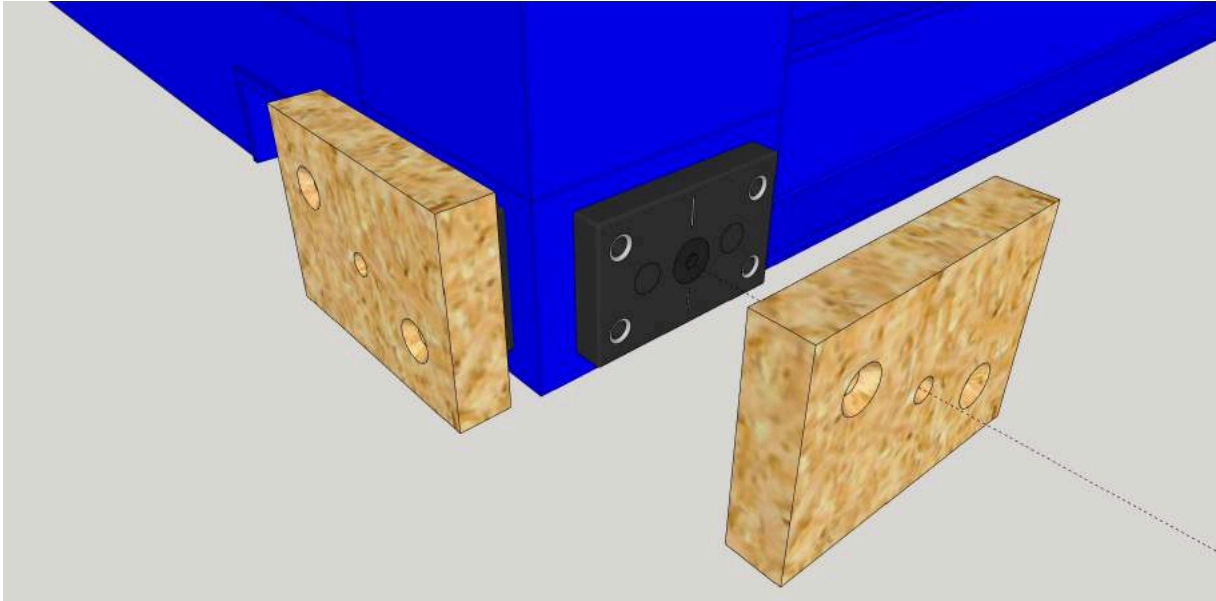

2. Prepare timber rails

3. Cut two lengths of 8"x2" and 2"x4" timbers to the length of your shipping container plus the thickness of your 8"x2" (usually 47mm) and 54mm for the depth of a Domino Clamp (22mm) and plywood wood adapter (30mm). This will provide an overhang of Approx 101mm.

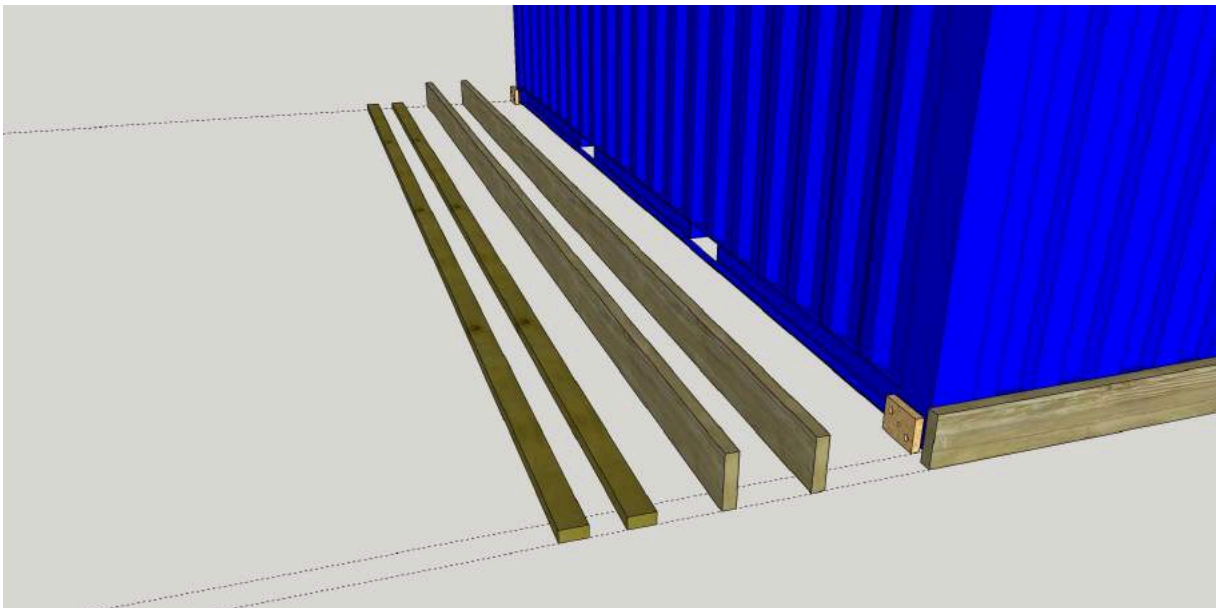

- Using the 4mm drill bit, pilot hole the back edge of each 8"x2" timber down its center, approximately every 600mm.

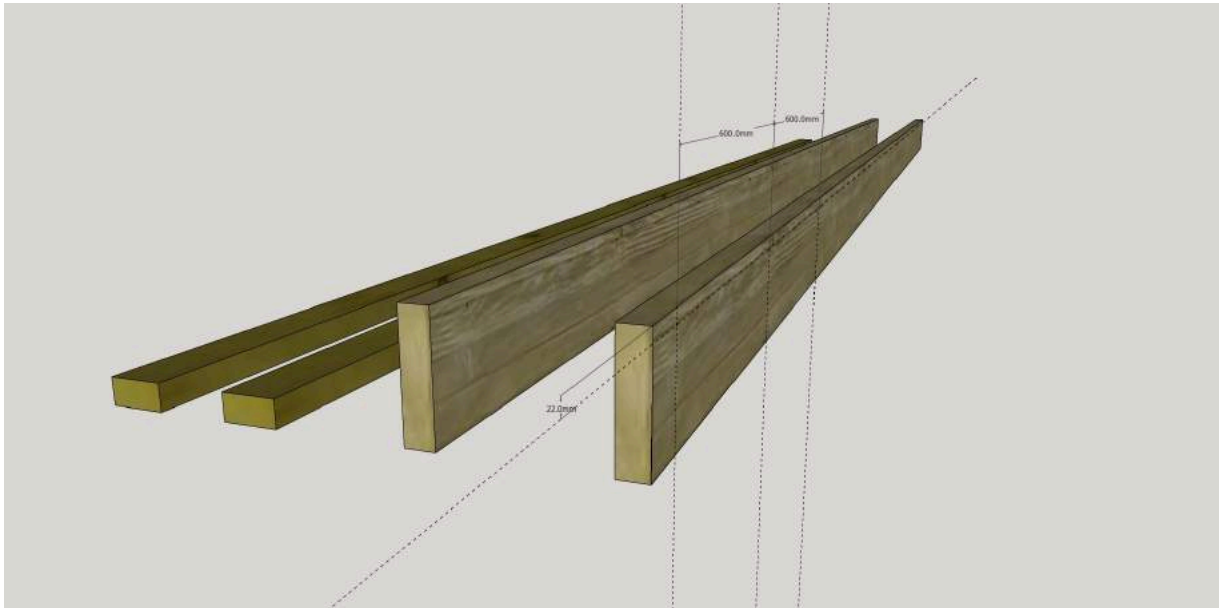

- Join the 4"x2" timber on edge to the 8"x2" using 90mm screws to form an L. These will form the top and bottom rails for your studs to fit to while providing a strong straight edge to span between the Domino Clamps.

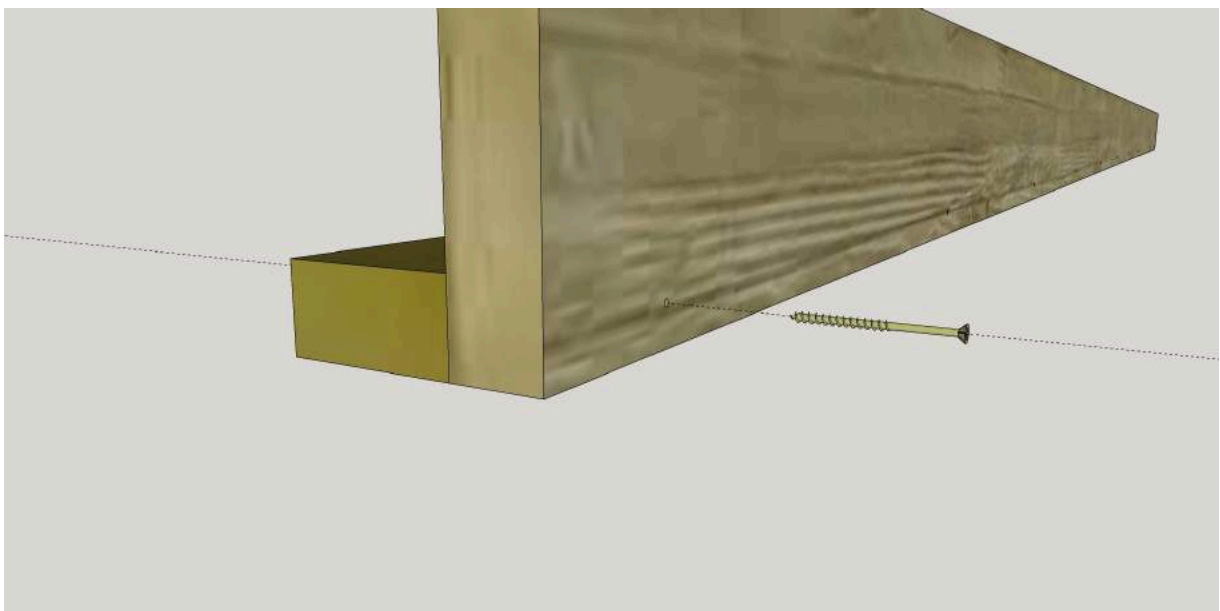

6. Position the lower rail so that the 4"x 2" is lowermost and pushed against the lower two plywood adapters. The top rail should have the 4"x2" uppermost. Both should be flush to the door end of the container and protrude past the rear end not more than the overhang mentioned in step 3 (approx 101mm).

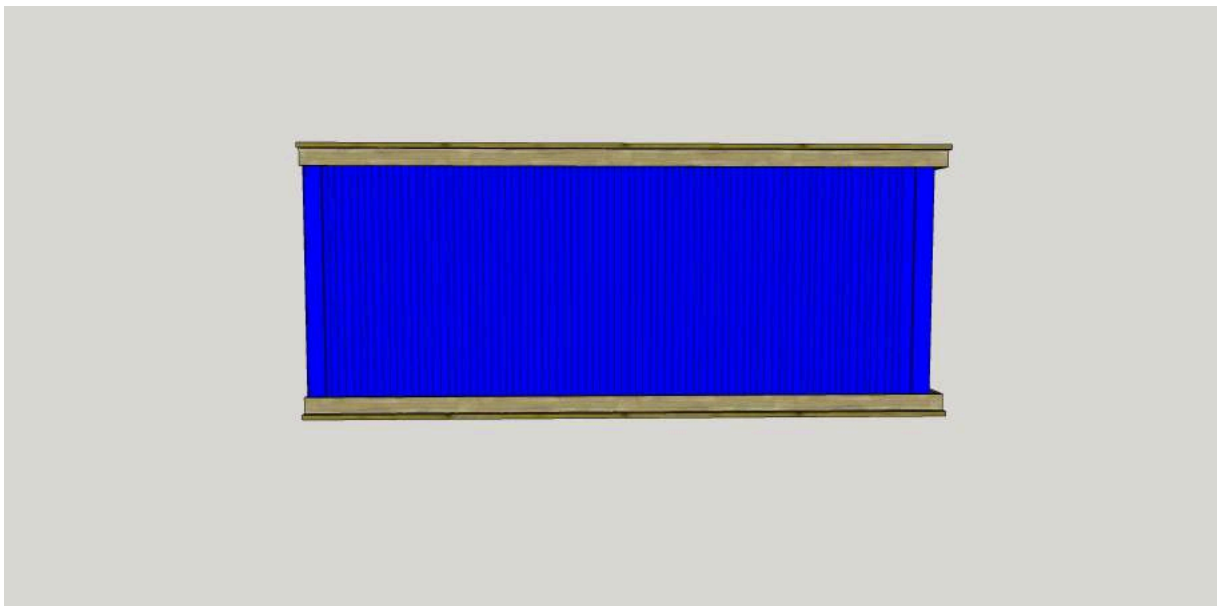
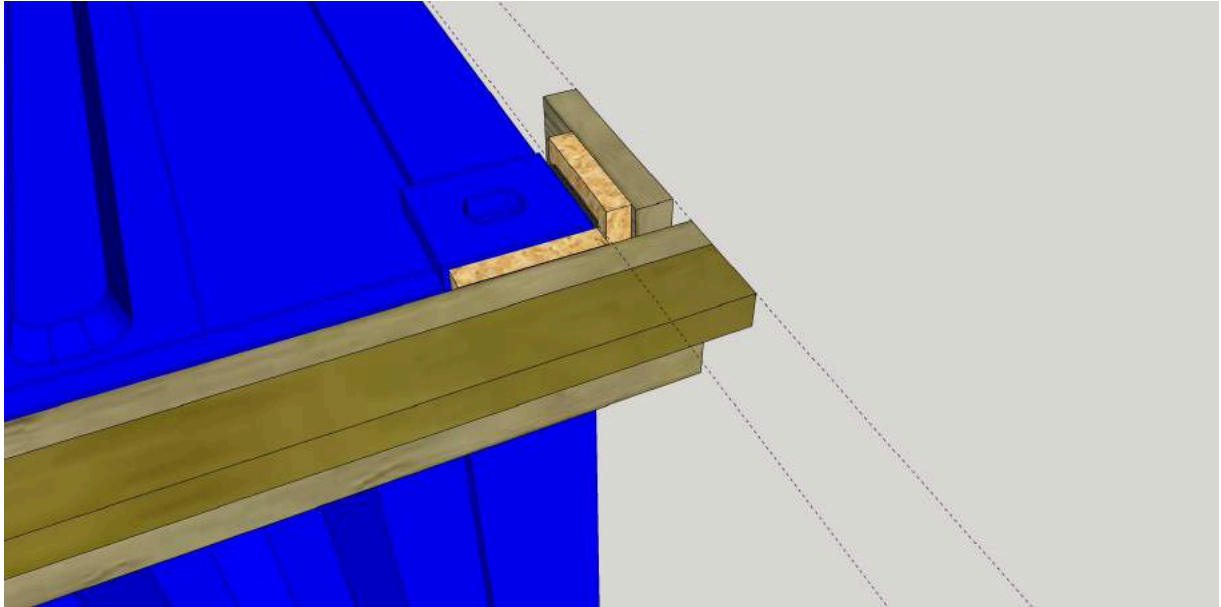

Want to get everything you need for your project?

[Check our Kits: Plywood Bolt on Adapter
for Timber & Domino Clamp](#)

- Using 70mm wood screws and piloting holes through the 8"x2" attach your lower rail at each end to the plywood adapter, being sure to avoid the two M12 screws holding the plywood adapter to the Domino Clamp. Approx four each end.

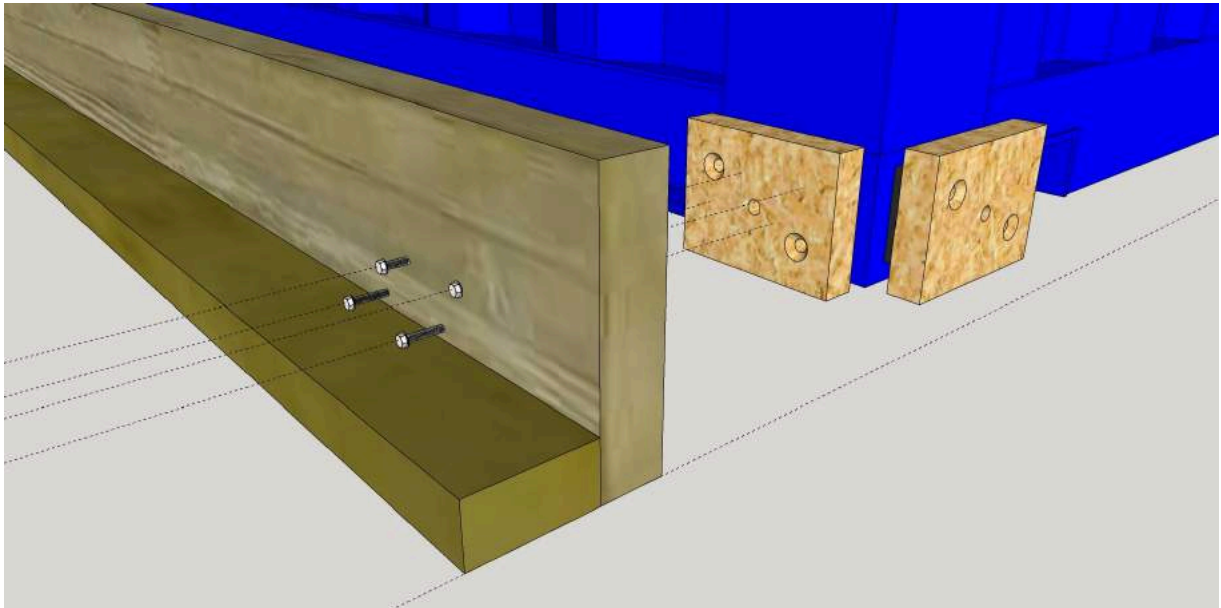

- Repeat this previous step for the top rail. It should be flush with the roof of the container, the 4"x2" is on the top edge and both rails are plumb and parallel to each other.

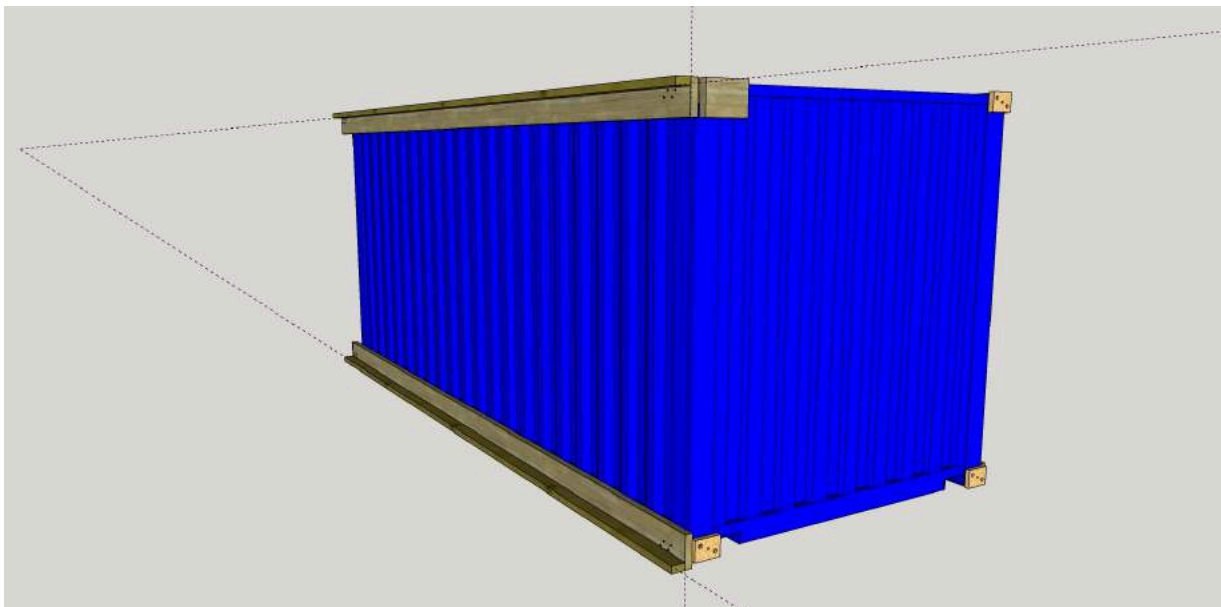

3. Cut and place studs on the long side of the container

9. Measure the distance between the top and bottom 4"x2" rail and cut 12 studs to fit this gap.

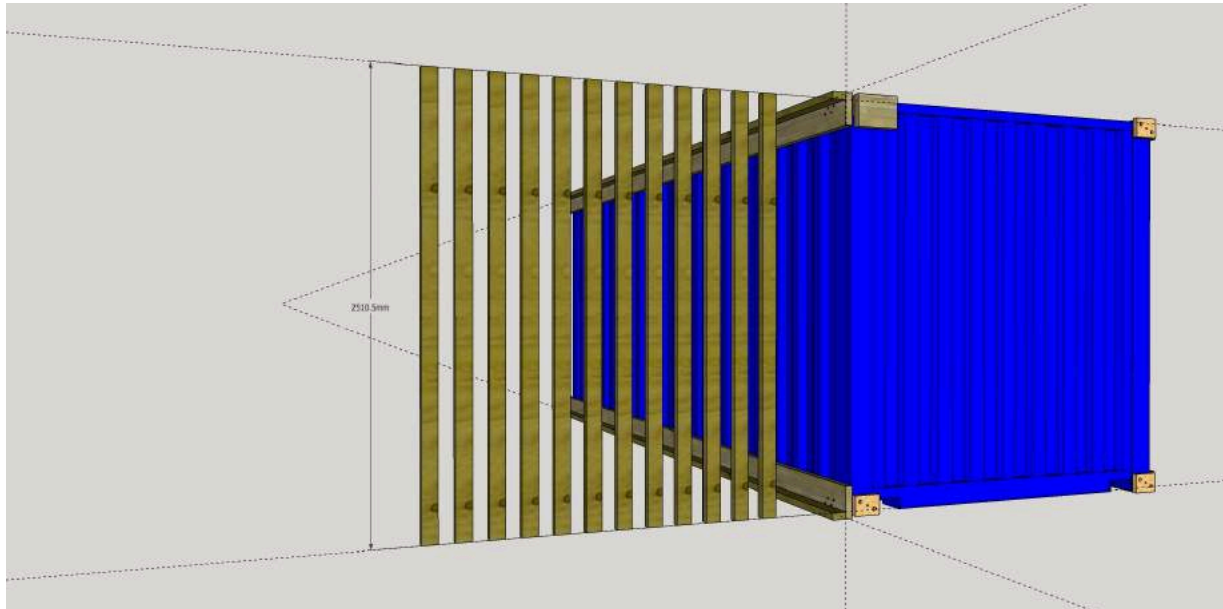

10. Place one stud flush at each end of the rails, secure into position using screws or nails diagonally through the stud into the rail.

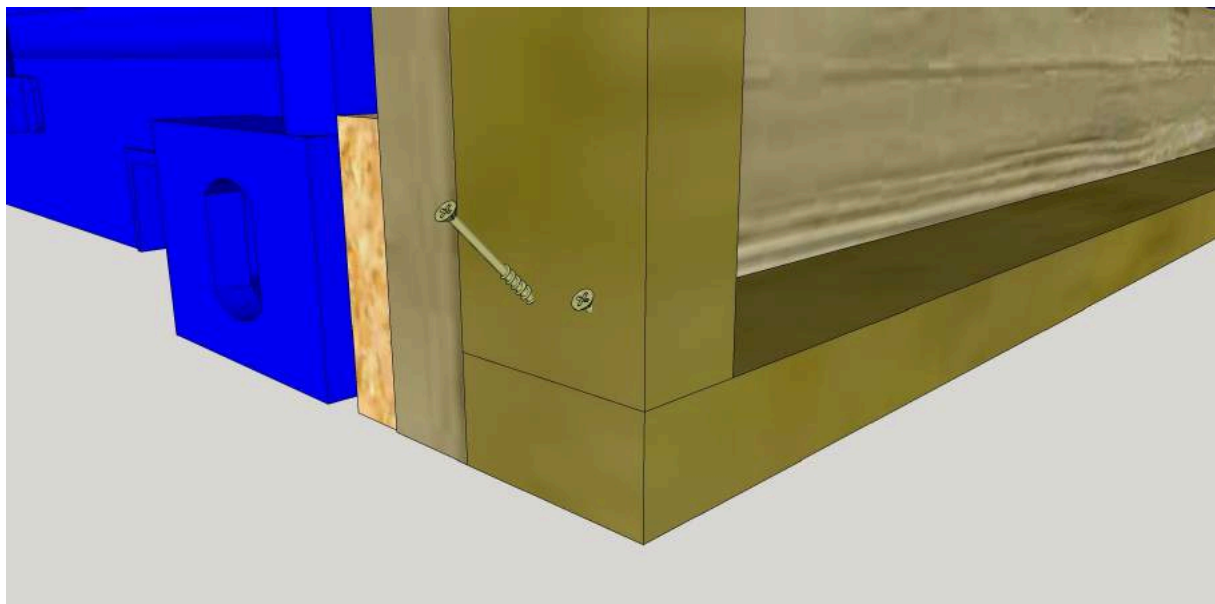

11. Take ten studs and make a notch the width and depth of your 4"x2" timber 2350mm from one end.

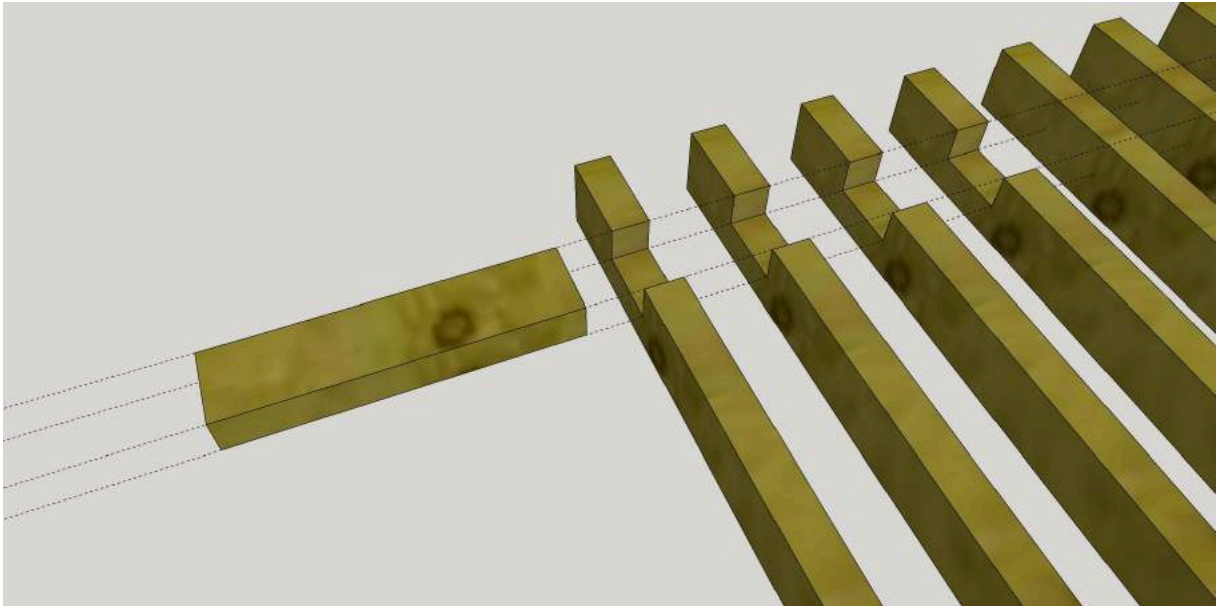

12. From the door end of both rails, mark every 610mm and place a stud centered over each mark and fix them into place. The last being placed against the end stud.

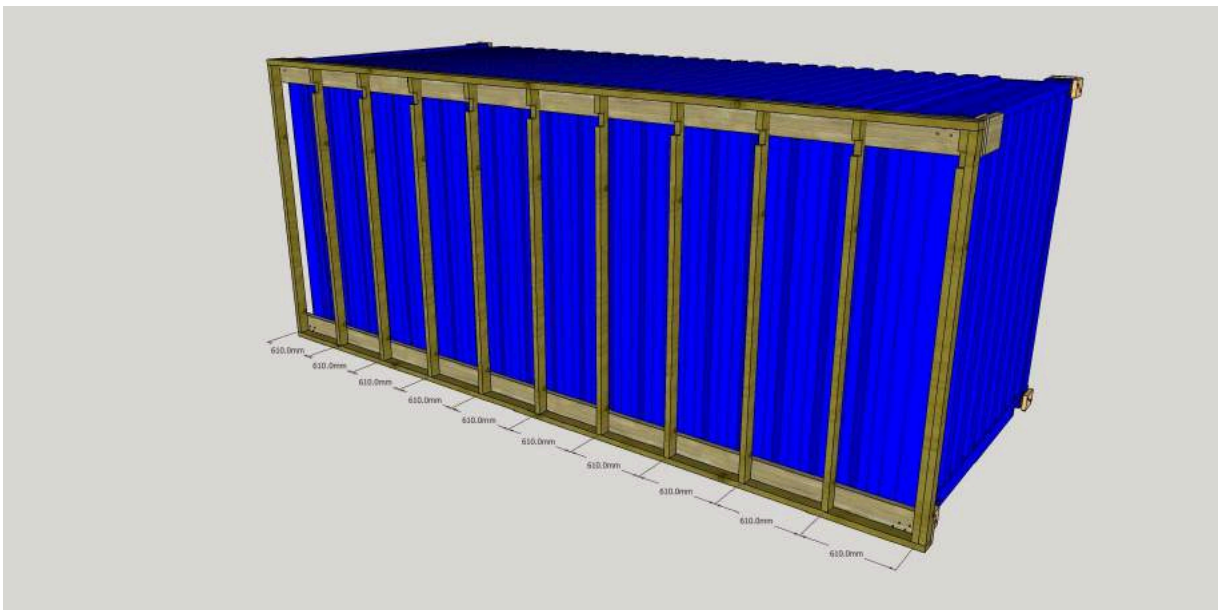

13. Next, cut noggins* to fit in between each stud and fix them approx 1220mm up from the lower edge of the bottom rail. It helps to stagger their position to make fixing through each stud easier.

**Also known as "blocking" (US), "dwangs" or "nogs" (Scotland/Australia/NZ),*

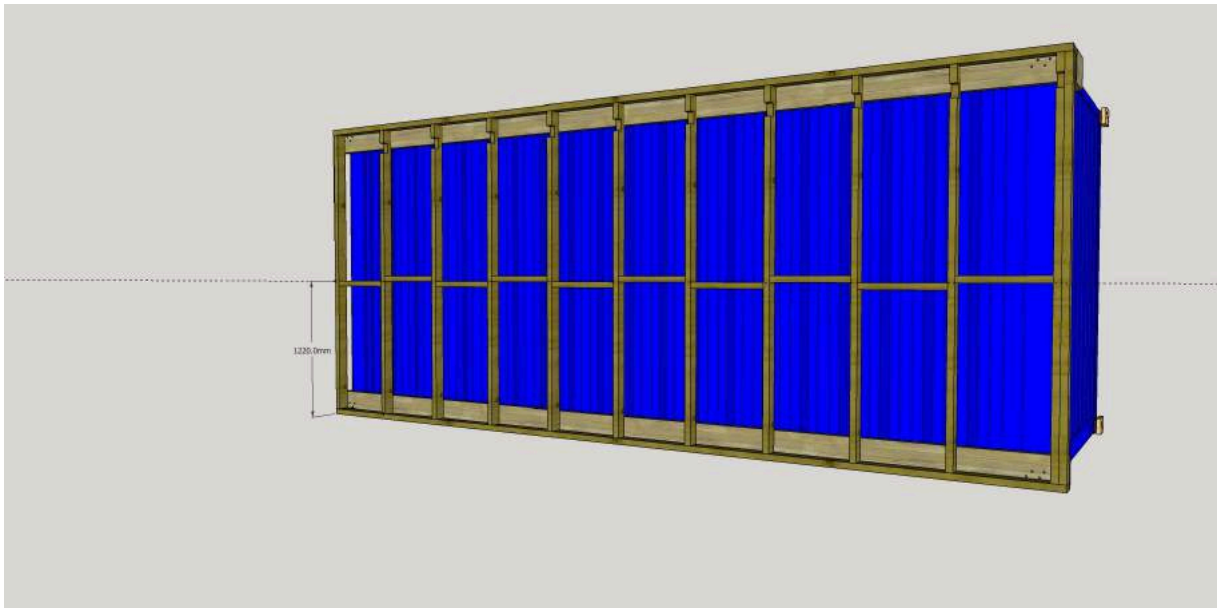

14. Cut a piece of 4"x2" to fit between the end studs, place on edge into the channel formed by the notches at the top of the intermediate studs and fix it through the face and ends.

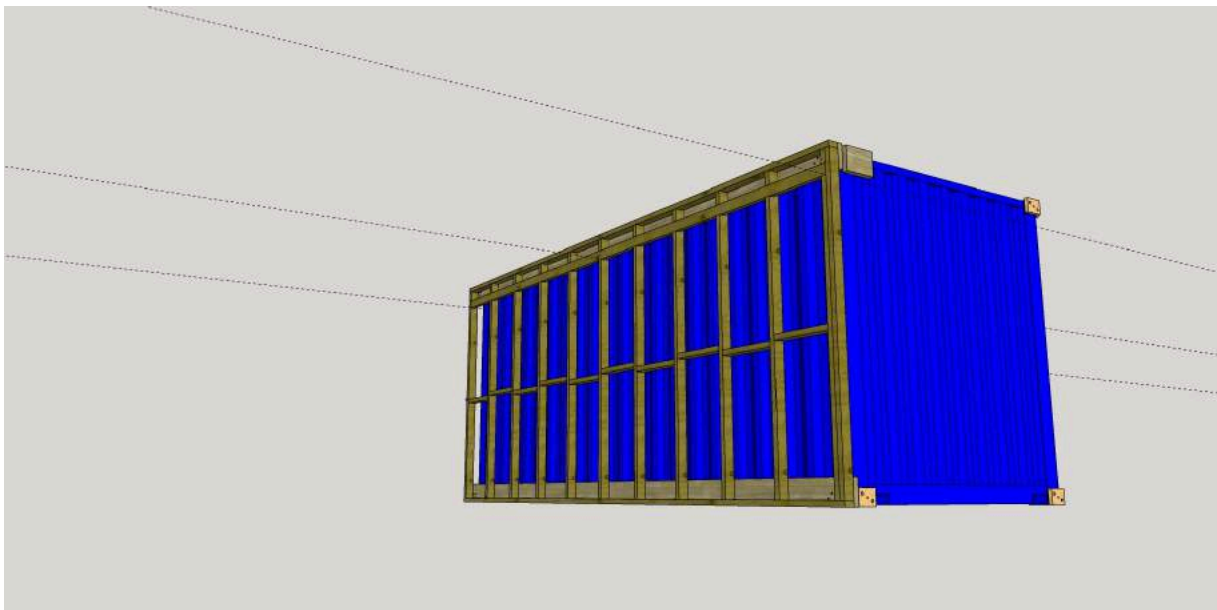

How to Frame A Shipping Container - Domino Clamps

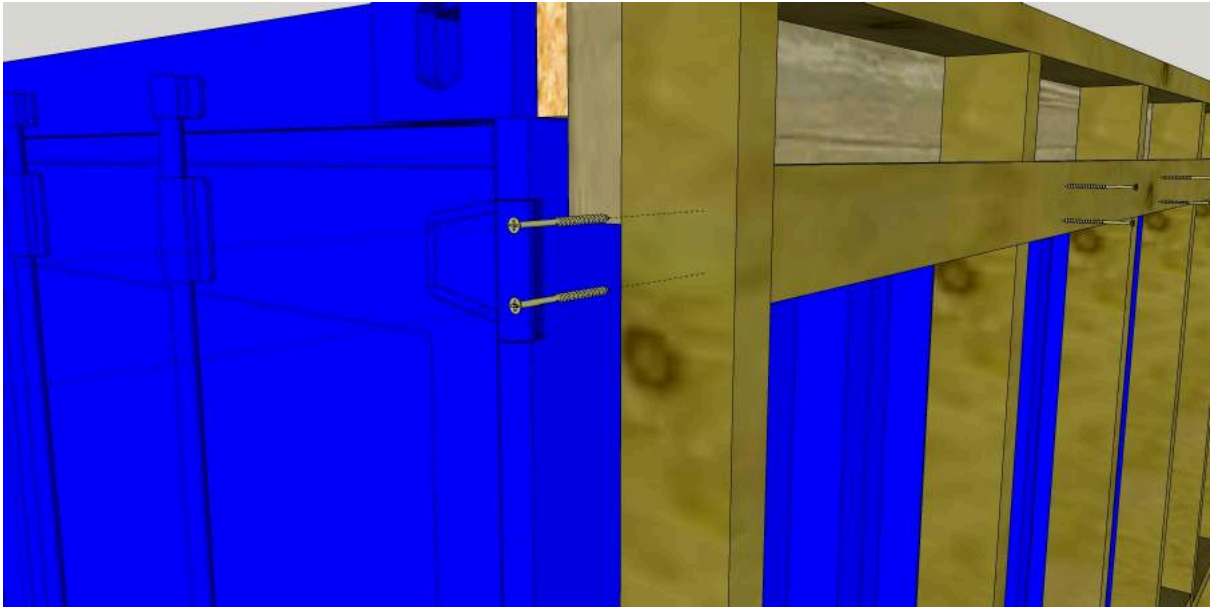

Repeat steps 3-14 on the opposite long side of the container.

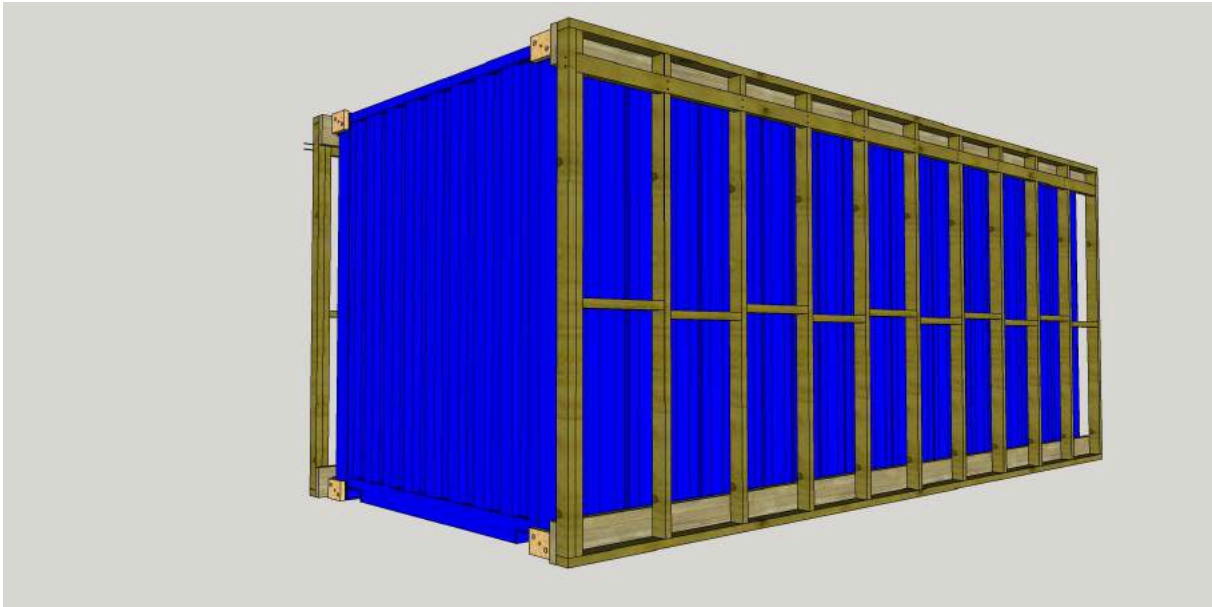

4. Frame the rear of the container

15. Facing the rear of the container, Measure horizontally between the inside edge of the 8"x2" side rails, and cut two lengths of 8"x2" to fit

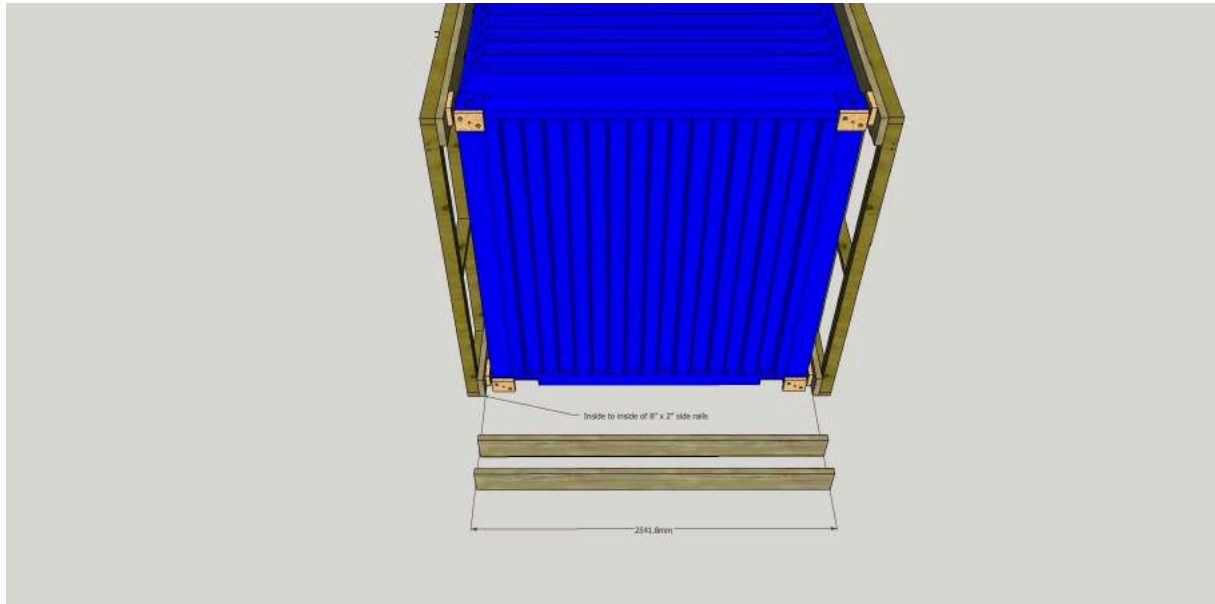

16. Next, measure the horizontal distance from the outer edges of the 4"x2" rails and cut 2 lengths of 4"x2"

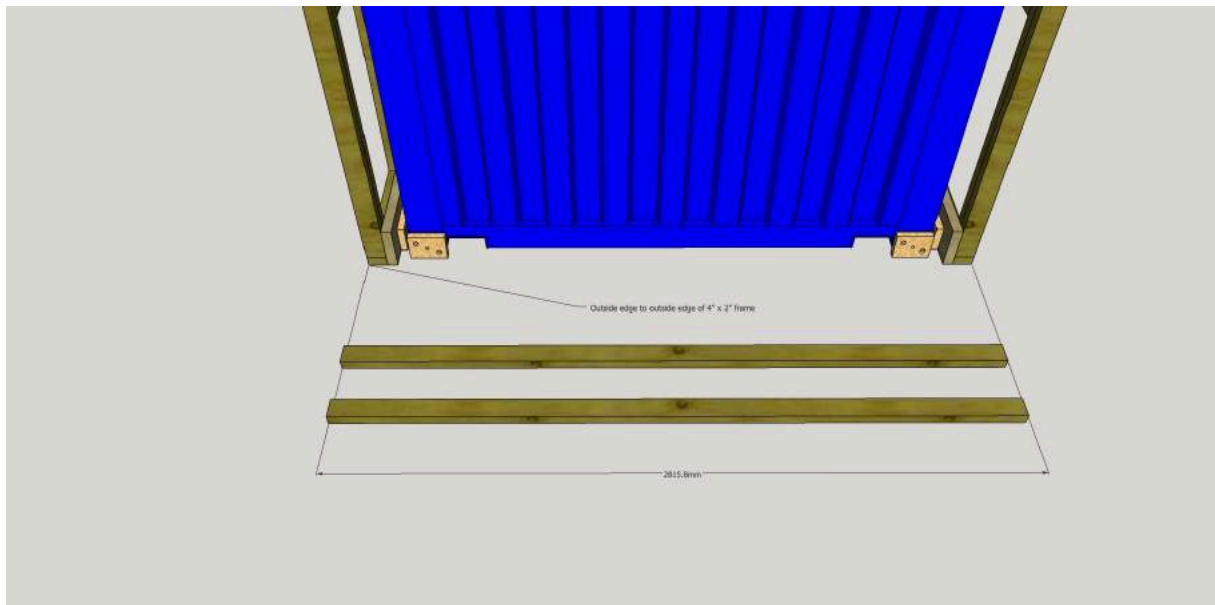

17. Fix the 4"x2" to the 8"x2" in the same manner as in step 5 so the 4"x2" protrudes by the combined thickness of your 4"x2" and 8"x2" (approx 90mm). It should end up flush to the face of the stud walls on each side of the container.

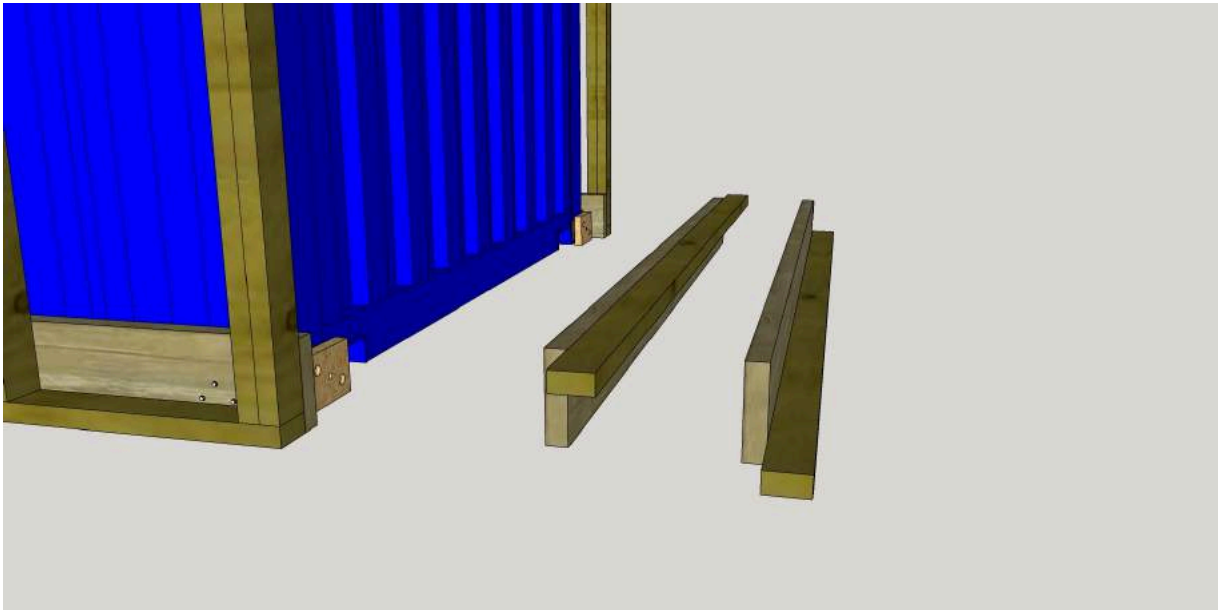

18. Now attach each of your short end rails to the rear of the container as in steps 7 & 8

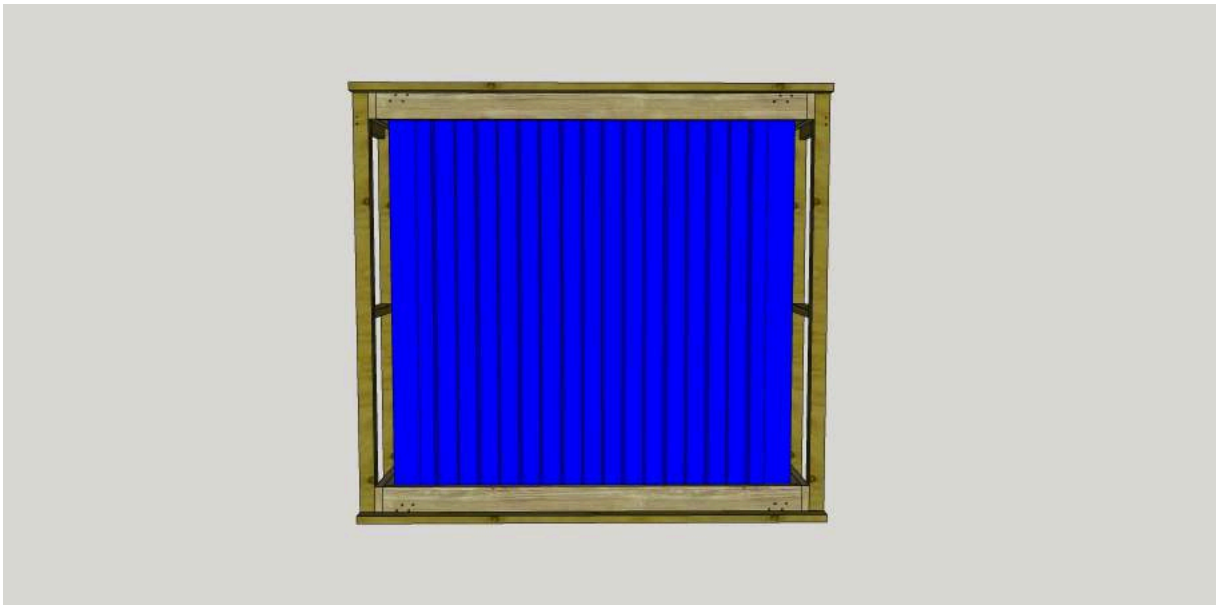

19. Repeat steps 9 to 14 but you will only need a total of 6 studs for the rear of the container - two ends and four intermediate studs with notches. Work from left to right when placing the studs.

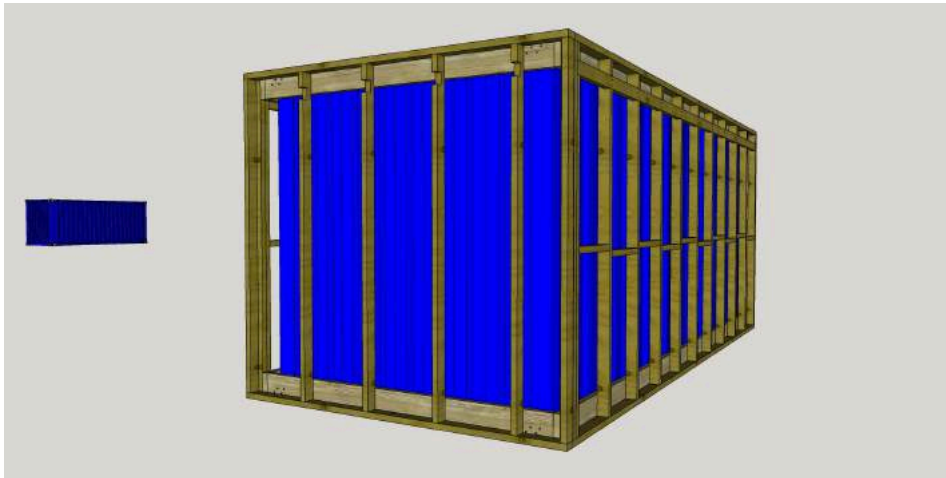

20. Your frame is now complete and ready to add exterior insulation or cladding!
[Watch our full Cladding-video](#)



**Check our
shop here**

.. for the Domino
Clamp and more
accessories for your
shipping container!

We would love to hear from you.

Let us know how you get on or ask us anything at hello@dominoclamps.com