

# SEWING, EMBROIDERY, QUILTING & OVERLOCKING 2022/2023

THE ENTIRE RANGE OF BERNINA MACHINES AT A GLANCE

VALENTINA BUKEEVA,  
DESIGNER



made to create **BERNINA**

**1893**

Karl Friedrich Gegauf, the founding father of BERNINA, invented the hemstitch sewing machine. This machine could sew 100 stitches a minute, causing a great sensation.

**1928**

His son Fritz Gegauf took over the factory in Steckborn in Switzerland. He was an engineer through and through whose ideas shaped the company and whose inventions are still in use today.

**1932**

Fritz invented the first household sewing machine and named it after his favorite mountain in the Eastern Alps in Switzerland – Bernina. And not only that! He then changed the name of the whole company from Gegauf & Co. to BERNINA.

**1938**

Under Fritz's direction, the first zigzag sewing machine from BERNINA came onto the market.

**1954**

Another important milestone occurred: BERNINA launched the first machine with the patented clip-on presser foot and buttonhole sewing function onto the market.

**1963**

Fritz's daughter, Odette Ueltschi-Gegauf, took over the company and brought out a sewing machine with a novel presser foot lifter. The Free Hand System, which raises the presser foot via a knee lifter, is still an important feature of almost every BERNINA today.

**1971**

A BERNINA with electric foot control followed, and in 1981 the first model with the stretch stitch function came out.

**1988**

Hanspeter Ueltschi, great-grandson of the company's founder, took over the company from his mother Odette and still manages BERNINA today. Under his leadership, BERNINA has developed into an iconic brand among passionate quilters throughout the world.

**1990s**

BERNINA made further important innovative leaps, culminating in the launch of the world's first sewing computer with a Microsoft Windows operating system in 2002.

**2012**

The patented BERNINA Hook was born – an amazing innovation from our Swiss engineers. It combines all the advantages of the world's previous two best hook technologies and is part of the 4, 5 and 7 Series.

**2015**

BERNINA went into a new line of business, with two completely new longarm quilting machines including frames.

**2017**

New embroidery functions were launched by BERNINA on the new 5 Series, the B 790 PLUS and the B 880 PLUS. BERNINA will continue to be a family-run business in the future as the 5th generation are already at work.

**2018**

BERNINA celebrated an important anniversary. It was 125 years since the company was founded by Karl Friedrich Gegauf – a very special year! To celebrate, BERNINA brought special limited-edition models with a gold faceplate to the market, as well as two real gold-plated presser feet and a golden anniversary box.

**2020**

BERNINA presents a new milestone and launches three revolutionary overlock machines: the L 850, L 860 and L 890. All models feature the unique One-step BERNINA Air Threader and are 100% designed and engineered by BERNINA.

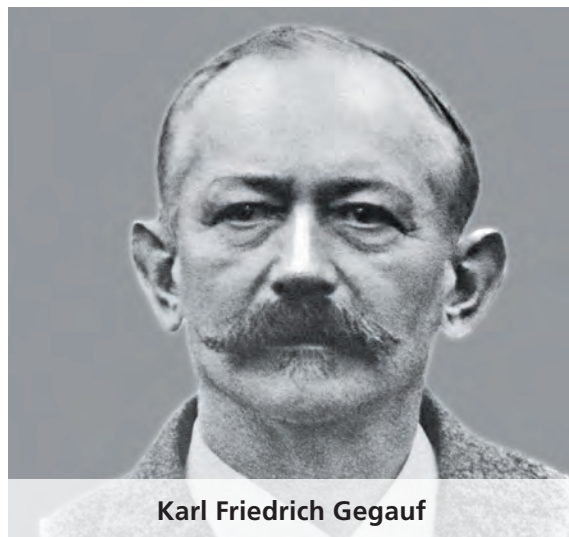

# WE ARE A SWISS FAMILY BUSINESS

BERNINA has stood for Swiss tradition since 1893. BERNINA was founded by my great-grandfather, the inventor of the hemstitch sewing machine. The corporate philosophy has remained the same over the years: we strive for the highest quality workmanship and aim to offer our customers an unrivaled sewing experience.

Sewing is about making something of your own, something beautiful. The focus is on individuality, whether you are sewing, embroidering, overlocking or quilting. But the do-it-yourself trend is also a trend towards sustainability, as many people see sewing as a conscious alternative to buying mass-produced clothes. Particularly during the current time, many people have discovered or rediscovered sewing as a fulfilling hobby and a meaningful way to spend time at home, which we are delighted about, of course. We have exactly the same philosophy! Our high-quality, durable products are intended for creative people who really enjoy sewing.

Caring for our customers is a top priority for us. So as well as training our specialist dealers, it is also very important to us to provide information, inspiration and tips and advice relating to sewing. Around the world, there is great enthusiasm for BERNINA, and the feedback is positive. This enjoyment and loyalty is the best incentive and the greatest motivation for me.



Sincerely,  
Hanspeter Ueltschi,  
Owner of BERNINA







## CONTENTS

<b>THE ENTIRE BERNINA PRODUCT RANGE AT A GLANCE</b>	4–5
<b>EXCLUSIVE FEATURES AND INNOVATIONS</b>	6–7
<b>SEWING, QUILTING AND EMBROIDERY MACHINES</b>	
BERNINA 880 PLUS	8–11
BERNINA 7 Series	12–15
BERNINA 5 Series	16–19
BERNINA 4 Series	20–23
BERNINA 3 Series	24–27
<b>OVERLOCKER:</b>	
BERNINA L 890 / L 860 / L 850	28–33
BERNINA L 460 / L 450	34–35
<b>LONGARM QUILTING MACHINES</b>	
BERNINA Q 24 / Q 20	36–37
BERNINA Q 16 PLUS / Q 16	38–39
<b>BERNINA EMBROIDERY SOFTWARE 9</b>	40–43
<b>FEATURE OVERVIEW</b>	
Overlockers	44–45
Sewing, quilting and embroidery machines	46–47

# WHICH BERNINA IS RIGHT FOR ME?

There is one particular characteristic that is apparent in all BERNINA machines\* – the quality. Regardless of size, quality is always our ultimate goal. The models differ in how they are used and in their range of functions. But how do you decide which BERNINA model is right for you? Find out more here: [www.bernina.com/machinerearch](http://www.bernina.com/machinerearch)

 Embroidery  Embroidery-enabled  Quilting  Sewing

## CUTTING EDGE OF SEWING AND EMBROIDERY



## THE CLEVER SEWING EXPERTS



## THE CREATIVE PARTNERS



## FIRST-CLASS SEWING, QUILTING AND EMBROIDERING



## THE STYLISH, COMPACT MACHINES



## THE VERSATILE OVERLOCKERS



 Overlock  Cover  Combo

# EXCLUSIVE FEATURES AND INNOVATIONS

The BERNINA name has always been synonymous with robustness and durability. Quality is evident in the precision of the stitches and the high needle penetration power when sewing thick fabrics. A wealth of exclusive and innovative functions and features and simple, intuitive operation sets BERNINA sewing machines apart from all others.

## TYPICALLY BERNINA

### SMART SCREENS

Almost all BERNINA sewing machines have a touch screen that lets you keep track of your settings at a glance.

### LARGE SEWING AREA

Attaching the freearm slide-on table to any model increases your sewing area, making it significantly easier to sew projects such as curtains, evening dresses, pant hems and pockets.

### BERNINA HOOK

The patented BERNINA Hook makes it possible to sew even longer stretches precisely, quietly and without interruption. With a stitch width of up to 9 mm, its centrally located driver allows it to run exceptionally quiet and smooth. It sews and embroiders with high precision up to 1,000 stitches per minute. The Jumbo Bobbin holds up to 70% more thread than standard bobbins.

### BERNINA ADAPTIVE THREAD TENSION

This innovation from BERNINA ensures the ideal thread tension as you sew, helping you to achieve outstanding stitch quality on both sides of the fabric. After you set the thread tension for the thread and fabric, the BERNINA Adaptive Thread Tension continuously checks it as you sew. It adjusts it unobtrusively and automatically whenever necessary. The result: the finest sewing and embroidery quality, with no need to even press a button!

### AUTOMATIC FOOT LIFTER

The automatic foot lifter lowers the foot when you start sewing and raises it at the touch of a button.

### AUTOMATIC PRESSER FOOT PRESSURE

The automatic presser foot pressure feature ensures that the presser foot has the ideal pressure for the selected stitch. The default setting can be adjusted for specific materials.

### AUTOMATIC THREAD CUTTER

The automatic thread cutter trims the thread and lifts the needle and presser foot with just the touch of a button.

### BERNINA DUAL FEED

The BERNINA Dual Feed is especially helpful when sewing delicate materials. When activated, the Dual Feed feeds the material from both the top and bottom, letting you sew difficult fabrics evenly and carefully.

### BERNINA FREE HAND SYSTEM (FHS)

The knee lifter lowers the feed dog and raises the presser foot simultaneously so that both hands are free to guide and maneuver the fabric.

### BERNINA STITCH REGULATOR (BSR)

The revolutionary presser foot for even stitch length in free-motion sewing. Effortlessly create beautiful, consistent straight or zigzag stitches.

### TOTAL STITCH CONTROL

Permanent or temporary altering of length, width and needle position of all stitches – even while sewing.

### CREATIVE CONSULTANT

The Creative Consultant displays the appropriate presser foot, presser foot pressure, needle, and feed-dog position, as well as automatically setting thread tension and the desired stitch.

### ON-SCREEN BUTTONHOLE MEASURING SYSTEM

Simply hold the button to the screen and measure its diameter. The length of the buttonhole is automatically set and the buttonhole can be sewn as many times as wished.

### STITCH DESIGNER

The Stitch Designer on the B 880 PLUS and B 790 PLUS allows you to create your own stitches by drawing your ideas directly on the touch screen. At the touch of a button, your design is converted into a stitch pattern. Built-in stitches can also be changed as desired. Add your custom-made stitch patterns to the stitch library for an even wider selection.

### PERSONAL PROGRAM

The default settings of the stitches can be customized and saved, making it easy to select your favorite settings whenever you want.

### PERSONAL MEMORY

The current stitch settings in each case are retained when switching between different applications.

### BERNINA PRESSER FEET

BERNINA feet are unique as both the shafts and soles of BERNINA presser feet are made of solid metal. More than 70 feet, including some for special applications such as the BSR foot or the punching set, make the process of sewing, embroidery and quilting easier and open up new creative opportunities.

### FREARM EMBROIDERY

Closed items, such as T-shirts, can also be embroidered. Different sizes of embroidery hoops are available for different garments.

### SMART DRIVE TECHNOLOGY (SDT)

The new advanced Embroidery Modules with BERNINA Smart Drive Technology (SDT) offer enhanced stitch quality, smoother and quieter movement and up to 55% higher embroidery speed (L module only).

### PINPOINT PLACEMENT

Accurately place embroidery designs with Pinpoint Placement, a great feature for easy positioning and alignment.

### INVISIBLE & SMART SECURE WITH INDIVIDUAL CUTTING

The Smart Secure function conveniently adds tie-on/off stitches to a design if none are pre-programmed. The Invisible Secure makes the tie-on/off formation completely invisible. The cutting of jump stitches at every length can be set individually.

### AUTOMATIC HOOP RECOGNITION

Automatically recognizes the embroidery hoop used as soon as it is fitted onto the embroidery module on the sewing machine, and adjusts the maximum embroidery area accordingly.

### EMBROIDERY CONSULTANT

The Embroidery Consultant chooses a sample motif for the desired application and helps with the choice of needle, foot, hoop and stabilizer.



*“The most dependable machine on earth.”*

TULA PINK, QUILTER AND FABRIC DESIGNER

**“MY BERNINA NEVER LETS ME DOWN.”**

- PERFECT STITCHES
- MORE POWER – LESS NOISE
- BUILT STRONG – BUILT TO LAST
- QUALITY TO ITS CORE

## THE ULTIMATE SEWING MACHINE

The ultimate in sewing technology: The BERNINA 880 PLUS is the queen of BERNINA sewing and embroidery machines. It features a huge selection of stitches, stitch patterns, lettering and embroidery designs, as well as the most modern software and sophisticated functions. Ease effortlessly into your work with the automatic threading system, the BERNINA Stitch Regulator and the BERNINA Dual Feed. You will immediately appreciate the needle penetration power when working with thick materials, the high speed and the extra-large working area. Innovations such as the Color Wheel, Shape Designer and Stitch Designer help you create your own designs and stitches. The advanced Embroidery Module L with Smart Drive Technology (SDT) is included as standard with the B 880 PLUS. The BERNINA 880 PLUS is the perfect sewing and embroidery machine for those with a real passion for sewing, embroidery and quilting.

### 8 THINGS YOU'LL LOVE:

- 1 **BERNINA Stitch Regulator (BSR)**
- 2 **Extended Freearm**
- 3 **Jumbo Bobbin**
- 4 **BERNINA Dual Feed**
- 5 **Fully Automatic Features**
- 6 **Extensive Stitch and Design Library**
- 7 **Total Stitch Control**
- 8 **Endless Embroidery Options**

#### BERNINA STITCH REGULATOR (BSR)

The BSR provides assistance during free-motion sewing. It ensures that stitches are exactly the same length at variable sewing speeds, allowing beginners to gain confidence quickly and giving experienced quilters additional peace of mind. The BSR foot is included as standard and enables free-motion sewing at high speeds using a straight or zigzag stitch.

#### EXTENDED FREEARM

The B 880 PLUS includes a meticulously engineered extended freearm area with a full 12 inches (30 cm) of space to the right of the needle and 5 inches (12 cm) in height. With this extra-large area, you have the added benefit of a very large embroidery field, an extended space in which to expand your creativity.

#### JUMBO BOBBIN

The unique Jumbo Bobbin provides up to 70% more thread capacity than standard bobbins, meaning fewer sewing interruptions. In addition, the bobbin pops in and out at the touch of a finger.

#### BERNINA DUAL FEED

The innovative BERNINA Dual Feed can even tame materials that are difficult to feed. It is easy to engage when needed and tucks completely out of the way when it's not.

#### FULLY AUTOMATIC FEATURES

Imagine a machine that automatically responds to your needs. The presser foot lowers at the start of a seam and lifts again at the end. The B 880 PLUS will even cut the thread for you at the end of a seam or with a color change in embroidery. The feed dog raises and lowers automatically for free-motion stitching and embroidery. And of course, fully automatic threading is yours at the touch of a button.

#### EXTENSIVE STITCH AND DESIGN LIBRARY

The B 880 PLUS offers a wide selection of over 1,700 stitches, clearly arranged into categories. 462 embroidery designs and 11 built-in alphabets can be conveniently selected at the push of a button.

#### TOTAL STITCH CONTROL

The stitch length and width and the needle position can be changed individually and saved. The Drag & Drop function enables individual stitches to be positioned precisely.

#### ENDLESS EMBROIDERY OPTIONS

The design editing function allows embroidery motifs to be positioned, mirrored, rotated, combined and resized with ease. Create curved lettering effects, adjust the stitch density and incorporate decorative stitches into embroidery designs. Automatically color-sort complex combinations, preview alternative color combinations on screen using the Color Wheel, and save everything to your machine or a USB stick. Would you like to embroider borders? The Endless Embroidery function guides you through the process. And finally, the Absolute Check feature helps you position your design precisely before embroidering.





## EMBROIDERY AT THE HIGHEST LEVEL WITH THE B 880 PLUS

The B 880 PLUS has exceptional functions to make embroidery even easier. In addition, it is compatible with all common file formats and has an integrated **Embroidery Consultant**, which helps you choose the right presser foot, the best needle and a suitable stabilizer for the fabric you are using.

Have you placed the fabric in the hoop at the wrong angle? No problem. With the **Pinpoint Placement function**, you can position your design on the fabric exactly where you want it – quickly and precisely, even if the fabric has not been placed straight. There's no need to use the template any more.

The **Group & Ungroup** function helps you to edit multiple motifs. Group objects to edit them all at the same time, or ungroup them to edit objects individually. You can also adjust the layers of the embroidery sequence individually and **Undo & Redo** lets you easily make changes while editing an embroidery design.

Manual **trimming of jump stitches** on the top side of the fabric is a thing of the past. Jump stitches are cut automatically and thread tails are located on the underside of the fabric for fabulous looking embroidery. The cutting of jump stitches can be set, subject to design properties.

The B 880 PLUS is also smarter than ever! You'll achieve brilliant embroidery results thanks to the **Invisible Secure** function which makes the enhanced tie-on/off formation completely invisible. The **Smart Secure** function adds tie-on/off stitches to a design if none are pre-programmed. Or, simply turn this function off to keep the original tie-on/off stitch settings of the design.

With the **extra-large Embroidery Module L**, large-scale designs can be stitched out with ease. The module is equipped with the new **Smart Drive Technology (SDT)**. This provides an enhanced embroidery experience due to improved stitch quality, smoother and quieter movements and an embroidery speed that is up to 55% faster.



# BERNINA 880 PLUS

## UNIQUE

### STITCH DESIGNER

Create your own stitches with the Stitch Designer function. Draw your ideas directly on the touch screen and the B 880 PLUS converts the design into a stitch pattern. You can also alter existing stitches in the same way, so continually expanding your stitch library.

### SHAPE DESIGNER (PATTERN CONFIGURATION)

The Shape Designer allows you to reproduce embroidery designs and reconfigure them with a single click. In combination with mirror-image effects, you can produce brand-new and unusual designs.

### COLOR WHEEL

The Color Wheel function lets you preview embroidery designs in various colors before you begin. This allows you to choose the most beautiful colors for your embroidery project.

FREE INSTRUCTIONS AND PATTERN  
DOWNLOADS FOR THE BERNINA 880 PLUS  
AT [BERNINA.COM/8SERIES](http://BERNINA.COM/8SERIES)

### Speed control:

with a maximum speed of 1,200 stitches per minute (spm) when sewing and 1,000 spm when embroidering



### Large, advanced Embroidery Module L with Smart Drive Technology (SDT):

embroider more precisely, quietly and quickly, with a very large embroidery area of 15.7" x 10.2" (400 x 260 mm)

### BERNINA Dual Feed

### Endless Embroidery:

Borders, sewing stitches, basting function, freearm embroidery

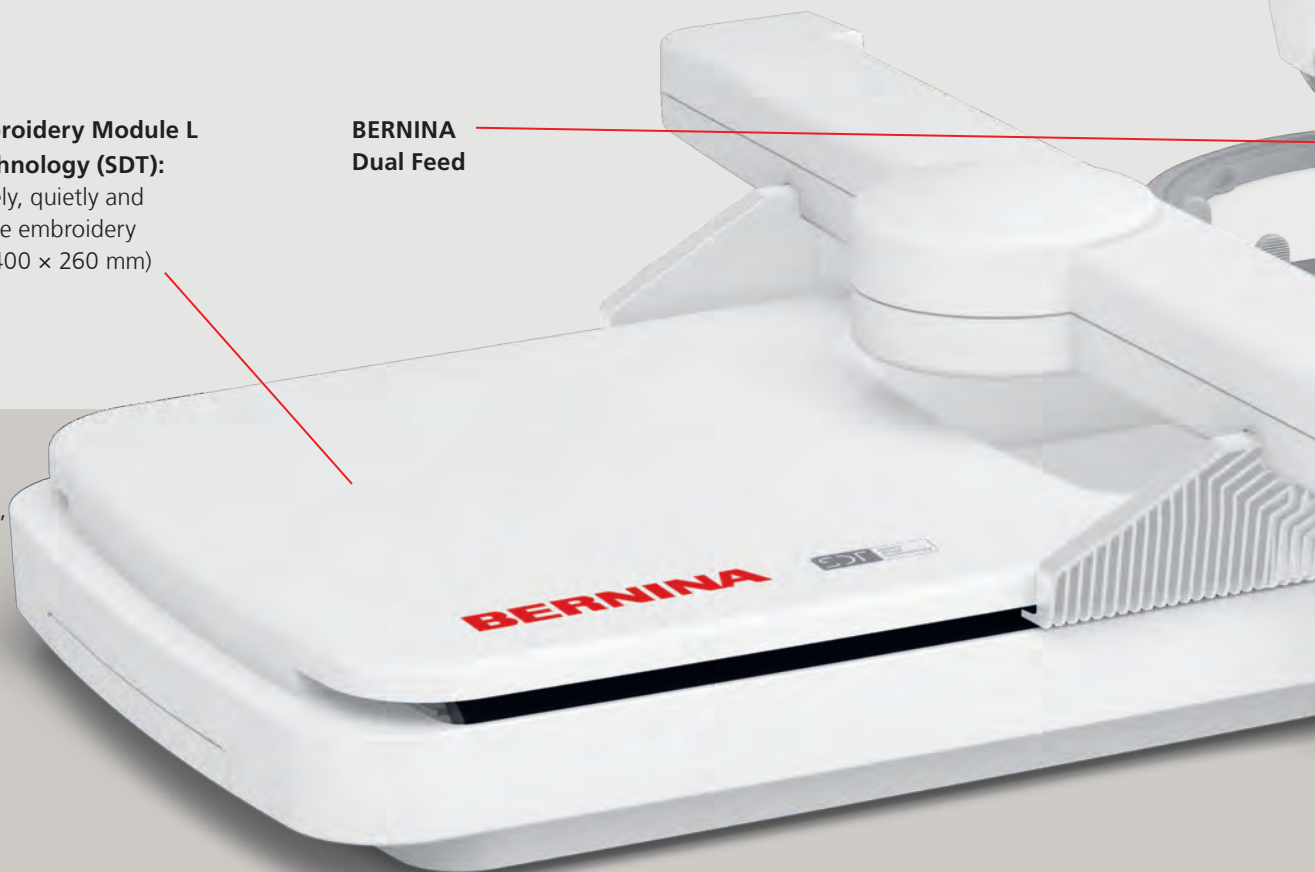



Sewing and embroidery tutorials and Creative Consultant

Front-loading bobbin winder

7" (17 cm) color touch screen provides access to a wealth of innovative functions

Absolute Stitch Control via multi-function knobs

Triple spool holder

30 bright LED lights

12" (300 mm) to the right of the needle

**BERNINA**  
SWISS ENGINEERING

USB interface for PC connection

Jumbo Bobbin with up to 70% more thread capacity



**Automatic Features:** Threading, thread cutter, presser foot lifter, needle detection

**BERNINA Free Hand System (FHS)** for simultaneous operation of presser foot and feed dog

# LEADING THE WAY IN SEWING AND EMBROIDERY

The BERNINA 7 Series combines the finest technology with innovation and all the space you need. The extended freearm means that all models are suitable for your largest sewing or quilting projects. The B 790 PLUS is the sewing and embroidery professional of the 7 Series, and comes with the High-End Embroidery Module L with BERNINA Smart Drive Technology (SDT) as standard, offering a particularly large embroidery area. The embroidery module can also be added to the B 735 and B 770 QE PLUS, making them sophisticated embroidery machines. The B 770 QE PLUS and B 790 PLUS feature an integrated Dual Feed ensuring even feed of smooth or fine materials. The unique BERNINA Stitch Regulator (BSR) can be used for effortless free-hand sewing on all models in the 7 Series (except the B 700). The centerpiece of the 7 Series is the BERNINA Hook. It sews precisely, quickly and quietly with a stitch width of up to 9 mm (B 770 QE PLUS and B 790 PLUS) or up to 5.5 mm (B 735). The BERNINA 700 is a dedicated embroidery machine and offers even more possibilities for embroidery lovers. In addition to the large Embroidery Module L with Smart Drive Technology (SDT), three embroidery hoops and a multiple spool holder are included as standard.

## THINGS YOU'LL LOVE ABOUT THE 7 SERIES:

- 1 **BERNINA Stitch Regulator (BSR)**
- 2 **BERNINA Dual Feed**
- 3 **Extended freearm for big projects**
- 4 **Total Stitch and Embroidery Control**
- 5 **BERNINA Adaptive Thread Tension**
- 6 **Sew and embroider with even greater ease**
- 7 **Creating Stitches with the Stitch Designer (B 790 PLUS only)**
- 8 **Beautiful, easy and flawless embroidery with SDT**
- 9 **Invisible and smart securing in embroidery**
- 10 **Cutting of jump stitches**
- 11 **Pinpoint Placement**
- 12 **Numerous embroidery features: Undo & Redo and Group & Ungroup (B 790 PLUS and B 700 only)**
- 13 **Help, Tips and Tricks**



*"I can count on BERNINA  
for all my precise stitching."*

**VALENTINA BUKEEVA, DESIGNER**

Valentina Bukeeva, originally from Russia and now living in Finland, is the founder of an online school of modern sewing and quilting. When she made her first quilt 10 years ago, she never dreamt it would grow into a successful school for sewing enthusiasts from around the world. Today, her specialty is fashion accessories such as intricately quilted and embroidered bags sophisticated enough to be featured in fashion shows.

### **BERNINA STITCH REGULATOR (BSR)**

All models in the BERNINA 7 Series (except the B 700) are equipped with the BSR function. The BSR foot provides assistance when free-motion sewing and quilting using straight or zigzag stitches. It ensures that the stitches are always exactly the same length when sewing at variable sewing speeds. The B 770 QE PLUS also offers the BSR 3 Mode for basting and the KickStart function for sewing or quilting without the foot control. The BSR foot is included as a standard accessory with the B 770 QE PLUS and the B 790 PLUS. It is available as an option for the B 735.

### **BERNINA DUAL FEED**

With the innovative BERNINA Dual Feed on the B 770 QE PLUS and B 790 PLUS, the fabric is fed from above and below. Even smooth and delicate materials are moved forward evenly and carefully.

### **EXTENDED FREEARM FOR BIG IDEAS**

The BERNINA 7 Series includes a meticulously engineered extended freearm with 10" (254 mm) to the right of the needle. On the Embroidery Module L with SDT (included with the B 790 PLUS and B 700, otherwise optional), extra-large designs can be stitched out precisely. If your requirements grow, all the models can be upgraded with a variety of additional accessories.

### **TOTAL STITCH AND EMBROIDERY CONTROL**

All the models in the BERNINA 7 Series offer the highest standard of Total Stitch and/or Embroidery Control. The stitch length, stitch width and needle position can be adjusted individually (except on the B 700). Personal settings can be saved and accessed at any time, and stitches and stitch patterns or stitch combinations as well as embroidery motifs can even be imported and exported via the USB port.

### **BERNINA ADAPTIVE THREAD TENSION**

This innovation from BERNINA ensures the ideal thread tension as you sew, helping you to achieve outstanding stitch quality on both sides of the fabric. After you set the thread tension for the thread and fabric, the BERNINA Adaptive Thread Tension continuously checks it as you sew, adjusting it unobtrusively and automatically whenever necessary.

### **SEW AND EMBROIDER WITH EVEN GREATER EASE**

The BERNINA 7 Series models carry out many tasks by themselves. The presser foot lowers automatically when you start sewing. Threading is semi-automatic and the thread is cut automatically when you reach the end of a seam or when you wish to change colors while embroidering.

### **CREATE YOUR OWN STITCHES**

The BERNINA 790 PLUS comes with the Stitch Designer. It lets you create your own stitches by drawing your ideas right on the touch screen. At the touch of a finger, your design is then turned into a stitch pattern. Built-in stitches can also be changed as desired.

### **BEAUTIFUL, EASY AND FLAWLESS EMBROIDERY WITH SDT**

The B 735, B 770 QE PLUS and B 790 PLUS can sew and embroider; the B 700 is a dedicated embroidery machine without a sewing function. Embroidery designs can be positioned, mirrored, rotated, formatted and combined on all models. The design editing function offers many additional options: you can create curved lettering effects, alter the stitch density and combine decorative stitches or alphabets with embroidery motifs. Complex combinations can be sorted by color, and alternative color options can be assessed. The finished design can be saved directly on the machine or onto a USB stick. Additional designs can also be uploaded to the machine via the USB port. With the large Embroidery Module, large-scale designs can be stitched out with ease. The module is equipped with the new Smart Drive Technology (SDT). This offers you an enhanced embroidery experience due to improved stitch quality, smoother and quieter movements and an embroidery speed that is up to 55% higher.

### **INVISIBLE AND SMART SECURING IN EMBROIDERY**

The Invisible Secure function enables tie-on/off stitches to be created in the stitch direction, thereby ensuring excellent embroidery results. The Smart Secure function adds tie-on/off stitches to a design if necessary. Alternatively, this function can be switched off.

### **CUTTING OF JUMP STITCHES**

A big plus is that the cutting of jump stitches can be set, subject to design properties. No more manual trimming on the top side needed. Flawless embroidery has never been easier.

### **PINPOINT PLACEMENT**

Pinpoint Placement allows embroidery designs to be aligned and positioned easily and accurately. Simply select two points on the screen and line them up with the markings on the hooped fabric. The design is aligned, rotated, resized and positioned as required. With the new Lock Function (B 770 QE PLUS and B 735 only), the size of the design is maintained during positioning.

### **UNDO & REDO AND GROUP & UNGROUP**

You can simply undo or redo steps while editing or combining designs to return to your initial position (B 790 PLUS and B 700 only). Combine designs to edit all at one time with group. Break apart designs to edit individually with ungroup. The design layer stitch-out sequence can also be customized.

### **HELP, TIPS AND TRICKS**

User friendliness and intuitive navigation are important to us: The Sewing and Embroidery Consultant (B 790 PLUS, B 735 and B 700 only) answers questions directly on the screen, and the Tutorial provides short instruction animations showing important work steps.

# BERNINA 790 PLUS

FREE INSTRUCTIONS AND PATTERN  
DOWNLOADS FOR THE BERNINA 7 SERIES  
AT [BERNINA.COM/7SERIES](http://BERNINA.COM/7SERIES)



## Large advanced Embroidery Module L with Smart Drive Technology (SDT):

embroider more precisely, quietly and  
quickly, with an extra-large embroidery  
area of 15.7" x 8.3" (400 x 210 mm)

## BERNINA Dual Feed

## Semi-automatic needle threader



BERNINA 770 QE PLUS



BERNINA 735

**Sewing and embroidery speed**  
of up to 1,000 stitches per minute

**Modern, 7-inch color TFT touch screen,**  
including Drag & Drop and Memory function

**Multi-function knobs**

**30 bright LED lights**

**10" (254 mm) to the  
right of the needle**

**BERNINA Free Hand System (FHS)**

**BERNINA Hook**



**BERNINA 700**

**BERNINA  
5 SERIES**

# THE CLEVER SEWING EXPERTS

We developed the BERNINA 5 Series for ambitious modern creatives. These machines are the perfect size and offer lots of advantages. All the models can be conveniently operated via the large color touch screen. The smart models in this series make sewing, embroidery and quilting even easier thanks to their practical functions. The all-rounder of the 5 Series is the B 590, as this sewing and embroidery machine comes with the new high-end Embroidery Module M with Smart Drive Technology (SDT). If you only want to embroider, the B 500, a dedicated embroidery machine with no sewing function, is the perfect choice.

## YOU'LL LOVE THESE FEATURES:

- 1 Total Stitch Control
- 2 Easy, beautiful embroidery
- 3 Large choice of stitches and stitch patterns
- 4 BERNINA Adaptive Thread Tension
- 5 Easy to use
- 6 Greater sewing ease and creativity
- 7 Jumbo Bobbin
- 8 Room for your growing needs



**"The B 570 QE makes me feel like a pro."**

**SUZY WILLIAMS, QUILT DESIGNER AKA "SUZY QUILTS"**

If quilts tell stories, then Suzy's tell of how modern design met beautiful stitches and lived happily ever after! And the matchmaker in this tale is none other than the B 570 QE. It's made especially for quilters who want perfect stitches. That's why Suzy loves it and you will too!



## TOTAL STITCH CONTROL

The models in the 5 Series give you complete freedom. All the stitch properties, such as stitch width, stitch length and the 11 needle positions, can be individually set and temporarily saved. The needle position, when you stop sewing, can be individually set to up or down. If a thread breaks, the Upper and Lower Thread Sensor on the B 590, B 570 QE and B 500 indicate this automatically. The intuitive operation is carried out by the touch of a finger on the large color touch screen. The BERNINA Stitch Regulator (BSR) can be used on all models (except the B 500). The BSR foot assists you with free-motion sewing and quilting with a straight or zigzag stitch, ensuring stitches of the exact same length even at variable sewing speeds.

## EASY, BEAUTIFUL EMBROIDERY

The automatic Invisible Secure ensures fantastic embroidery results and Smart Secure adds securing stitches to a design if they are not already preprogrammed. Cutting jump stitches manually is also a thing of the past as this happens automatically. The Thread-Up Command lowers and raises the needle when you start embroidering and brings the bobbin thread to the top of the fabric so you can secure the threads manually. This leaves the underside thread-free. The practical Thread Away Mode pulls threads to the underside after they have been cut automatically with a quick movement of the embroidery hoop. This leaves the surface free of thread ends (B 590, B 570 QE and B 500 only).

## LARGE SELECTION OF STITCHES AND STITCH PATTERNS

There are hundreds of decorative stitches as well as various sewing alphabets available to you. With the Triple Stitch function on the B 590 and B 570 QE, you can give your creations the wow factor, and with the automatic buttonhole function every buttonhole is professional. There are also lots of preloaded embroidery designs to choose from, and you can upload your own embroidery designs via the USB port and edit them on the touch screen. You can rotate, mirror, resize or change the color – whatever you want.

## BERNINA ADAPTIVE THREAD TENSION

This innovation from BERNINA ensures the ideal thread tension as you sew, helping you to achieve outstanding stitch quality on both sides of the fabric. After you set the thread tension for the thread and fabric, the BERNINA Adaptive Thread Tension continuously checks it as you sew, adjusting it unobtrusively and automatically whenever necessary. The result: the finest sewing and embroidery quality, with no need to even press a button!

## EASY TO USE

With its user-friendly software and touch screen, the 5 Series is very easy to use. All the models allow designs to be edited on the screen during the embroidery process. You can rotate, mirror, combine and rearrange with a simple touch of the screen. The Undo & Redo, Group & Ungroup and Pinpoint Placement functions make editing and precise positioning of embroidery designs a breeze.

## GREATER SEWING EASE AND CREATIVITY

The BERNINA Free Hand System (FHS) lets you operate the presser foot and feed dog simultaneously with a knee lifter, leaving both your hands free to guide the fabric. The slide-on table clicks easily into place providing space to spread out larger projects, and greater comfort and convenience when sewing.

## JUMBO BOBBIN

The Jumbo Bobbin is exactly as its name suggests: it holds up to 70% more thread than standard bobbins, resulting in significantly fewer sewing interruptions. Another very convenient feature is that the bobbin is inserted from the front, so there is no need to remove your sewing.

## ROOM FOR YOUR GROWING NEEDS

A wide range of accessories and presser feet are included as standard. As your requirements increase, the models in the 5 Series can be upgraded with additional accessories for sewing, embroidery and quilting. A practical accessory box in a modern design that can be attached to the machine easily with a magnet is also included.



## The freedom to create endless design combinations

What do wildly talented cosplayers love about the B 590? Everything. It's faster than their looming deadlines. It's powerful enough for crazy materials. And its embroidery capabilities are absolutely amazing. Cosplayers love this machine and so will you!

# BERNINA 590

FREE INSTRUCTIONS AND PATTERN  
DOWNLOADS FOR THE BERNINA 5 SERIES  
AT [BERNINA.COM/5SERIES](http://BERNINA.COM/5SERIES)



**Advanced Embroidery Module M  
with Smart Drive Technology (SDT)**  
embroider more precisely and quietly,  
with a large embroidery area of  
15.7" x 5.9" (400 x 150 mm)

Semi-automatic  
needle threader

Automatic  
thread cutter

16 bright  
LED lights

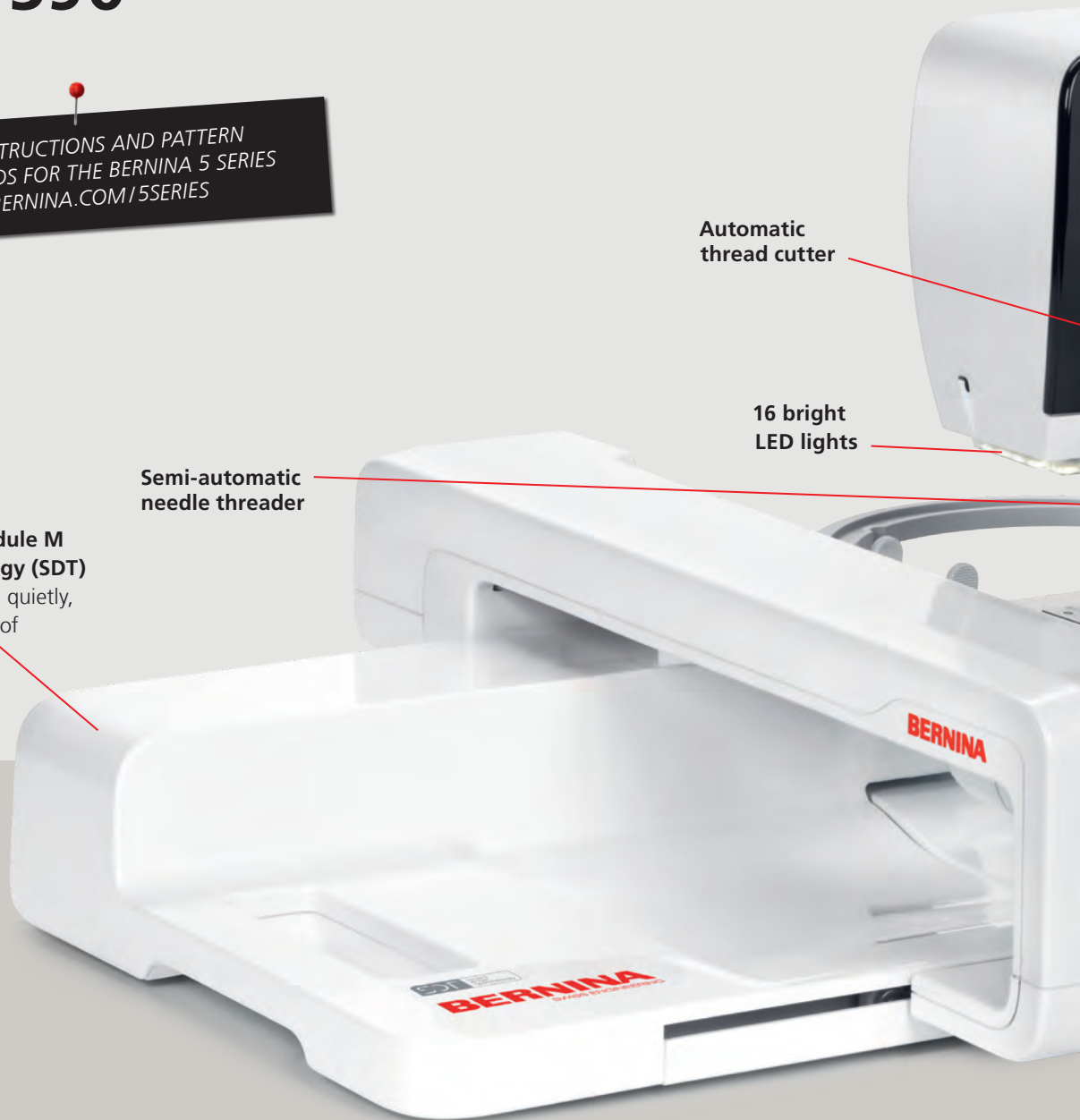

BERNINA 570 QE



BERNINA 535



**BERNINA Free Hand System (FHS)**  
for simultaneous operation  
of presser foot and feed dog



**BERNINA 500 EMBROIDERY**

**BERNINA  
4 SERIES**

# MADE FOR **MAKERS.**

More power, speed, perfection and comfort! Making your sewing and crafting life easier and more enjoyable is what the 4 Series is all about. Innovative features free you to be the sewist, crafter, quilter, maker you have always wanted to be.

## FOR THOSE WHO CREATE. **THE 4 SERIES OFFERS FEATURES, THAT YOU NEVER WANT TO BE WITHOUT:**

- 1 Impeccable stitches with the BERNINA Hook
- 2 Powerful DC motor for thick materials
- 3 Fewer interruptions with the Jumbo Bobbin
- 4 Front-loading bobbin for easy access
- 5 Convenient automatic thread cutter (B 475 QE & B 480)
- 6 7" (177.7 mm) right of the needle
- 7 Easy-to-navigate 4.3" color touch screen
- 8 Adjustable presser foot pressure
- 9 Large selection of sewing stitches and alphabets
- 10 BERNINA Stitch Regulator functionality (optional for B 475 QE & B 480)
- 11 Creative Sewing Consultant for on the spot advice



**"The B 480 is an essential part of my studio."**

**YVONNE REICHMUTH,**  
SWISS FASHION DESIGNER AKA "YVY"

Highly sophisticated. Brilliantly simple. Like Yvonne's beautiful designs, her B 480 expertly combines simple, easy-to-use features with innovative technology ensuring that her stitches are impeccable on everything from leather to delicate fabrics. Her machine exceeds her expectations. You can expect the same.

### **YOUR CREATIVITY. YOUR DECISIONS**

Want to go where your creativity takes you? The 4 Series models let you make all the creative decisions. Like choosing the stitch length and width or deciding the needle position. If you want the needle down when it stops, you can. And all that control is conveniently located at your fingertips on the large, intuitive touch screen.

### **FRONT-LOAD JUMBO BOBBIN FOR MORE SEW TIME**

Fewer stops and starts is the result of a bigger bobbin that holds up to 70% more thread than standard bobbins. And since it is conveniently changed from the front, there's no need to remove your project.

### **STITCHES PLUS LETTERS PLUS MORE OF WHAT YOU LOVE**

There's a huge choice of sewing and decorative stitches as well as alphabets. The 4 Series machines offer over 150 to 250 decorative stitches and up to 5 alphabets. And the B 475 QE is full of special quilting stitches. The choices are many and every one of them yours.

### **SIMPLE ON-SCREEN EDITING**

Be as creative as you dare with your stitches by editing directly from the easy-to-navigate touch screen while you work. Simply tap the screen to choose your favorite stitches. Or maybe you want to combine different stitches. Or create a new look by extending your decorative stitches using Pattern Elongation (available on B 480). Or create a custom pattern with Pattern Repeat.

### **EXCLUSIVE BERNINA ADAPTIVE THREAD TENSION**

Achieve permanent control of the thread tension. Once it's adapted to the thread and fabric, the thread tension adjusts automatically while sewing. And the innovative BERNINA Hook keeps every stitch consistent and precise.

### **BERNINA HOOK INSIDE**

The BERNINA Hook is the centrepiece of the BERNINA 4 Series. It's fast while also being quiet. It's efficient while housing a Jumbo Bobbin. It's front-loading for convenient, fast changes and easy cleaning and oiling.

### **BERNINA FREE HAND SYSTEM (FHS)**

The BERNINA Free Hand System lets you lift or lower the presser foot and lower the feed dog at the same time, using only the knee lifter, keeping your hands free to guide your projects. The knee lifter is standard on the B 480 and B 475 QE and optional on the B 435.

### **SPECIAL QUILTING STITCHES**

With 40 quilting stitches plus 29 utility stitches and 4 sewing alphabets pre-loaded and ready to go, the B 475 QE is well equipped for all your quilting and creative needs.

### **BERNINA STITCH REGULATOR – BSR (OPTIONAL)**

The amazing BSR regulates impeccable equal-length straight and zigzag stitches at variable sewing speeds during free-motion quilting. BSR is optional for models B 475 QE and B 480 and is not available on the B 435.



*"You don't need to sew perfect, the machine will make it magic."*

**TIFFANY PRATT, DESIGNER AND MAKER**

Talented. Energetic. Creative. Bold. A maker like Tiffany relies on the B 435 and B 475 QE to be powerful, easy to handle, fast and magical. Day in and day out. And her BERNINA never fails to deliver. She loves it and you will too.

# BERNINA 480

**Variable sewing speed**  
Maximum speed of 900 stitches per minute

**Adjustable presser foot pressure**

Adjusts for thick or thin fabric to eliminate skipped stitches

**Easy access at the front**

**Automatic thread cutter  
(B 480 / B 475 QE)**

Saves time: it cuts the thread and raises the needle in one step

**Easy threading**

The semi-automatic needle threader makes threading super easy

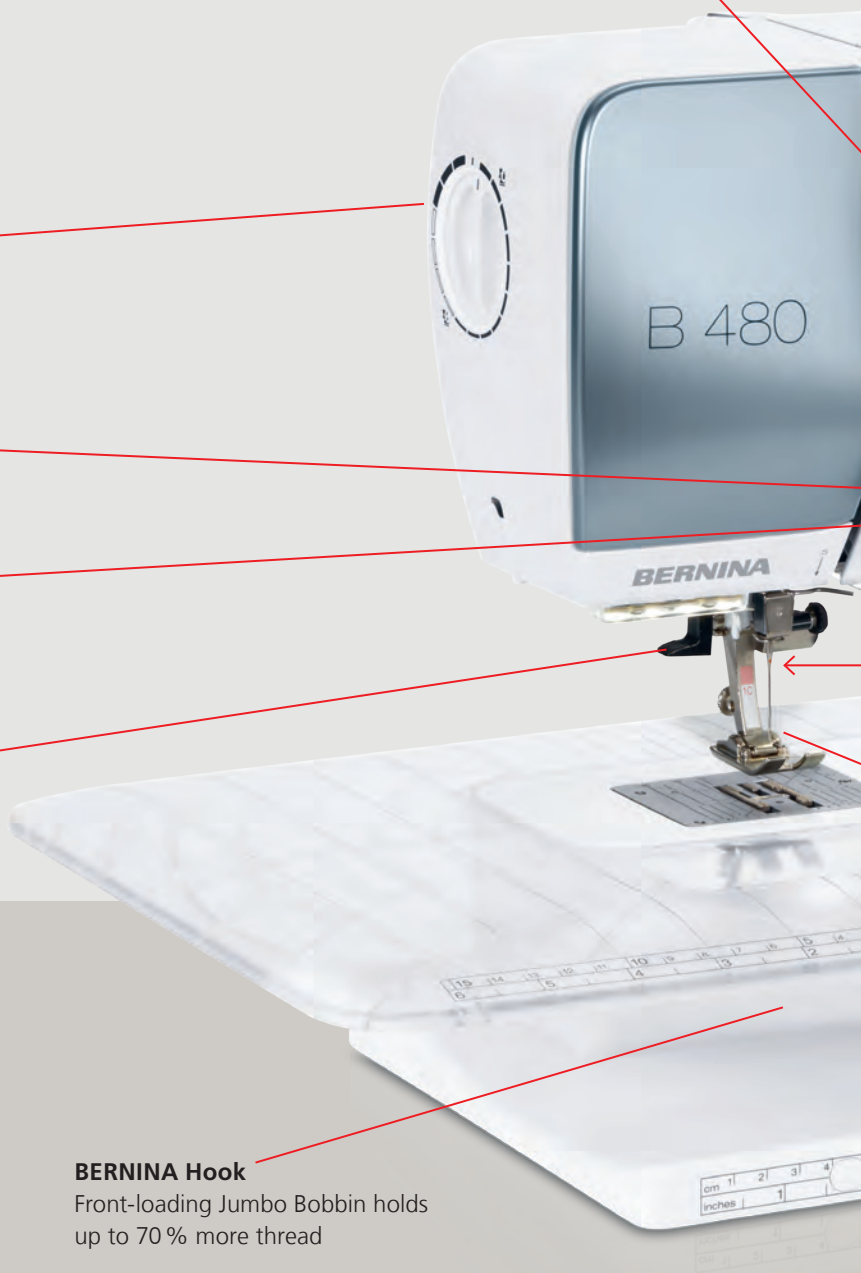

FREE INSTRUCTIONS AND PATTERN  
DOWNLOADS FOR THE BERNINA 4 SERIES AT  
[BERNINA.COM/4SERIES](http://BERNINA.COM/4SERIES)

**BERNINA Hook**

Front-loading Jumbo Bobbin holds up to 70 % more thread



**BERNINA 480**



**BERNINA 475 QE**



**Modern, color touch screen**  
Easy to use with simple navigation

**Multi-function knobs**  
Stepless rotation, easy to operate

7" (177.7 mm) to the right of the needle

**BERNINA Free Hand System (FHS) including knee lifter**  
(optional with the B 435)

**BERNINA Stitch Regulator (BSR) enabled (B 480 / B 475 QE)**  
Works with straight or zigzag stitch and with feed dog lowered. BSR foot is optional.



**BERNINA 435**

# THE STYLISH ENTRY-LEVEL MACHINES

Robust quality, user-friendly and easy handling, coupled with an elegant design. Stylish sewing really is that easy!

## QUALITY FROM TOP TO BOBBIN

Our 3 Series machines are full of the latest technology. Their robust, durable quality ensures nothing stands in the way of your creativity. On the outside, the simple, user-friendly operation makes your maker life easy. A bright modern LCD screen provides an overview of the function settings at all times and the direct selection buttons allow quick access to all the functions.

## BRING YOUR CREATIVITY TO LIFE

Whether you want to sew your own clothes, make unique accessories or just repair something, the B 335 and B 325 are always at your side. You can sew all kinds of fabrics and expertly finish or embellish your projects with decorative stitches. However you express your creativity, your BERNINA will bring it to life.

## EASE OF USE COMES STANDARD

The most frequently used functions are easily accessible right in front of you, for example the start/stop button for sewing without the foot control or the reverse sewing button. The position of the needle when you stop sewing is set using the needle stop up/down button – incredibly helpful when sewing corners. The pattern end and mirror image (B 335 only) features, useful when sewing decorative stitches, are also located here. And with the slide speed control, set the speed you want, up to 900 stitches per minute.

## GOOD THINGS COME IN SMALL PACKAGES

16 cm (6.3 inches) to the right of the needle is plenty of room for your ideas, but takes up hardly any space in your sewing room. And the freearm makes manipulating closed items, such as sleeves or trouser legs, particularly easy and convenient.



*"I know I have a new best friend with the B 335."*

**ANNIKA VICTORIA, DIY LOVER AND YOUTUBER**

Annika is young, talented, creative and crazy unique. The YouTuber from Sydney, Australia, knows exactly what her sewing fans want: uncomplicated patterns that are fun to sew. And, as her down-to-earth, you-can-do-it videos show, her BERNINA 335 is the go-to partner she can count on. She loves her BERNINA 3 Series. You will too!



### **BERNINA FREE HAND SYSTEM (FHS)**

Raise or lower the presser foot while simultaneously lowering the feed dog – without having to take your hands off the fabric thanks to the BERNINA Free Hand System. The knee lifter makes it possible! The FHS capability with the knee lifter is optional on the B 335. The FHS is not available on the B 325.

### **NICE AND CONVENIENT**

The semi-automatic threader makes threading the needle simple and the bright LED sewing light lets you sew through the night. Direct selection buttons let you select the perfect stitch quickly and easily, which can be conveniently adjusted using the stitch width and length altering buttons. Individual stitch settings can then be saved in the memory, losing nothing. And usefully, you can monitor everything on the screen.

### **ALL-ROUND EXCELLENCE**

With stitched lettering (sewing alphabet) and a large selection of decorative stitches, make your sewing projects as unique as you are. Save time with functions like the button sew-on program. Or find the space you need on the popular freearm extension table, which gives you more room around the presser foot and needle. The accessory package includes various presser foot soles; and the Buttonhole Foot with Slide #3A is included in the B 335 to sew automatic buttonholes. The 3 Series is easily upgraded with a wide range of optional accessories.

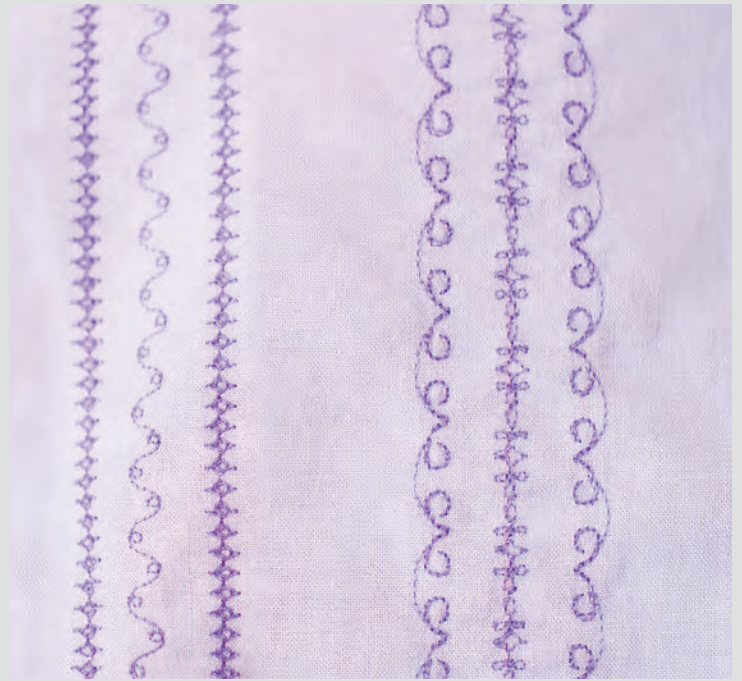

**BERNINA 335**



**BERNINA 325**

# BERNINA 335

LEARN MORE ABOUT THE  
BERNINA 3 SERIES  
AT [BERNINA.COM/3SERIES](http://BERNINA.COM/3SERIES)

**Variable sewing speed**  
Up to 900 stitches per minute

**Ergonomic**  
Easy-to-reach buttons:  
Start/stop and reverse sewing

**Semi-automatic needle threader**  
Practical built-in threading guide



**LCD screen**

Overview of all the settings

**Convenient stitch adjustment**

Stitch width, needle position and stitch length are easy to set with a button

**Memory**

Stitch settings are easy to save in the memory

**Direct selection buttons**

Quick, direct selection of different stitches

**Built-in BERNINA Free Hand System (FHS)**

Simultaneous raising of the presser foot and lowering of the feed dog with the knee lifter (B 335 optional)



# SEW LIKE A PRO WITH A BERNINA OVERLOCKER

Overlockers make an ideal addition to your sewing machine! Their absolute speciality is finishing edges of all kinds. They create professional, robust seams and hems in high-stretch materials. Rolled hems and decorative flatlock seams are a breeze, and functions such as differential feed and Micro Thread Control (mtc) enable you to sew immaculate stitches with any combination of thread and fabric. It's also possible to create gathering and ruffles, and there are endless design possibilities using decorative threads.

Do you want to trim and neaten the edge of the fabric while creating professional seams and hems, all in one process? What sounds too good to be true becomes a reality with an overlocker. Whatever you sew, you'll complete your projects quicker than ever before and what's more, your sewing will look more professional – inside and out.

## THERE ARE LOTS OF REASONS TO GET AN OVERLOCKER:

- Professional neatening of fabric edges
- Superb results quickly and easily
- Ideal for knitted, stretch and woven fabrics
- Perfect for delicate silk or satin fabrics
- Can also sew heavy linen, fleece and denim fabrics
- Differential feed for pucker-free seams or for gathering and ruffles

Unlike a sewing machine, an overlocker can sew with up to four or five threads simultaneously. The threads are intertwined to create the highly elastic seams needed for knitted fabrics, jersey and all kinds of stretch fabrics.

By choosing an overlock/coverstitch combo machine, you have all the stitches combined on one machine. A combo machine has three functions: it can sew overlock stitches, coverstitches and combo stitches! A dedicated overlocker does not include either coverstitches/chainstitches or combo stitches. But with these two types of stitches, you can make your garments look even more professional!

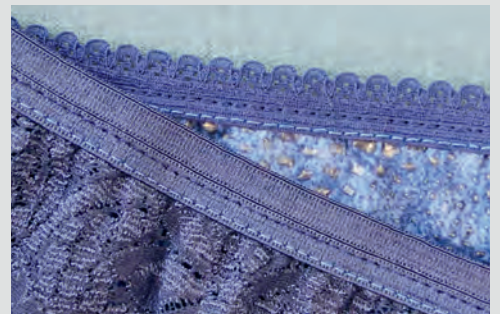
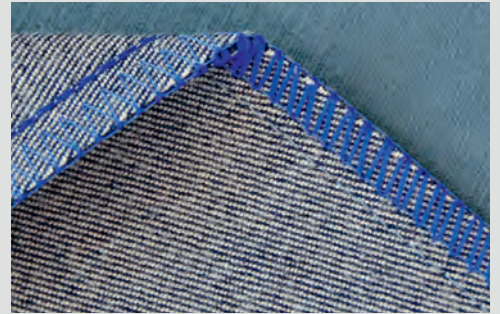

Coverstitch is a flat hem that overcasts the fabric edge while also remaining elastic and flat. 3- or 4-thread coverstitch hems are well-known as classic T-shirt hems. However, coverstitch can also be used as a flat joining seam if the seam is in direct contact with the skin and should not rub against the skin – such as in swimwear, underwear and sportswear.

Chainstitch can be used to join fabrics and the seam allowance is ironed open. It is suitable as a hem and for topstitching due to the attractive chainstitch formation.

Combo stitches secure fabrics with chainstitch while the fabric edges are simultaneously overcast with a 3- or 2-thread overlock stitch. This results in wide, robust seams such as those used in the home textiles sector.

## BERNINA L 8 SERIES



# OUR NEW OVERLOCKERS: DESIGNED AND DEVELOPED BY BERNINA IN SWITZERLAND



**BERNINA L 890**



**BERNINA L 860**



**BERNINA L 850**

### ONE-STEP BERNINA AIR THREADER

The exclusive One-step BERNINA Air Threader makes threading the loopers incredibly easy. The threads are magically moved through the machine via one simple step on the foot control. So both hands remain free. The machine automatically sets the loopers in the correct position for the air threader – no turning the handwheel or searching for the right position. Simply press the foot control and you're off.

### GRAND SEWING SPACE

The space offered on the L 8 Series machines is generous by any definition. You get more room to the right of the needles and more workspace height than ever before on a BERNINA overlocker. The practical freearm is an advantage when sewing closed textiles, because you can easily slide sleeves or cuffs over it.

### CONVENIENT AND EASY TO USE

The L 8 Series overlockers offer a range of convenient features to help you sew to the highest standard: pressing the foot control with your heel raises or lowers the needle by a half stitch, making handling easier. The BERNINA Free Hand System (FHS) lets you raise and lower the presser foot with your knee – great for sewing corners. And the presser foot can be swung out to the side for easier access to the needles.

*“The ultimate overlocker.”*

**ANDREA MÜLLER**, TEXTILE DESIGNER AKA “JOLIJOU”

As the designer of the brand “Jolijou”, Andrea Müller creates colorful jersey fabrics and loves bringing them to life in new projects using the BERNINA L 850 overlocker. In particular, the One-step BERNINA Air Threader and the fast sewing speed with outstanding stitch quality win this mother of three's admiration when projects have to be done on a limited schedule.



# BERNINA L 890

## THE REVOLUTIONARY OVERLOCK / COVER- STITCH COMBO

As a combo machine, the L 890 has three different functions: overlock stitches, coverstitches and 4-thread and 5-thread combination stitches. It creates professional seams, finished edges and rolled hems and combines all the functions of an overlocker and a coverstitch machine in one model.

### INTUITIVE OPERATION VIA TOUCH SCREEN

The L 890 is easily operated using the centrally located Color Touch Screen. Stitch selection, individual stitch settings, stitch properties or memory – the touch screen has all of the information available at your fingertips anytime you need it and allows you to make changes while sewing. A Creative Sewing Consultant, Stitch Optimizer and helpful animations for all functions are available to you. Stitch selection can be performed in two modes: Advanced users can use Expert Mode to apply all their desired settings directly, quickly and individually, while Guided Mode provides step-by-step support.

### TOTAL STITCH CONTROL

The stitch length, thread tension and differential feed can be adjusted while sewing. The amount of the overedge thread can be precisely adjusted at any time thanks to the Micro Thread Control (mtc).

### QUICK THREADING

Color-coded One-path Threading enables you to switch from an overlock stitch to a coverstitch or to a combination stitch in no time at all.

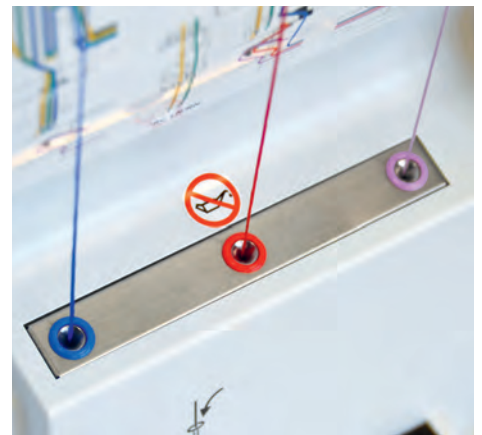

*“I finally have everything I’ve ever wanted.”*

**JEN BEEMAN, PATTERN DESIGNER**

Jen Beeman loves designing fashions in fine jersey fabrics. Her machine of choice for trouble-free, smooth-looking stitches on woven and knit fabrics is the L 890. The outstanding stitch quality gives her garments the professional look she expects. She especially loves the convenient One-step BERNINA Air Threader, for fast, easy threading of the looper threads. As a combo machine, the L 890 offers the right stitch for every idea. The touch screen allows Jen to keep an eye on everything, while focusing on her creativity.

# BERNINA L 860 AND L 850

## TWO UNIQUE OVERLOCKERS

The BERNINA L 860 and L 850 are classic overlockers. They are suitable for all thread and fabric combinations, particularly high-stretch and knitted fabrics. They sew using up to 4 threads and offer the perfect seam for every sewing project. The L 860, like the L 890, is operated via the centrally located color touch screen, while the L 850 is simple to operate without a touch screen.

### EXTREMELY FAST, PRECISE & QUIET

The L 860 and L 850 reach a maximum sewing speed of 1,500 stitches per minute. The foot control allows you to control the motor, providing strong, consistent stitching power as well as precision at any sewing speed. Not only can you sew quickly, but you can set the sewing speed as slow as 250 spm. Using the BERNINA Foot Control gives you the ability to sew stitch-by-stitch, making precise lines and flawless curves a simple process. And all of this is achieved with the extremely quiet hum of a BERNINA.

### QUICK THREADING

Threading the needles is simple thanks to the integrated needle threader and the automatic needle stop up function.

### TOTAL STITCH CONTROL

On the L 860, the settings can also be changed individually and 100 stitches can be saved in the Personal Program. The L 850 offers various individual settings. Achieve perfect results with just a few adjustments in no time. You can get started right away with the recommended default settings or you can use the numerous options to personalize the stitch settings for endless creativity.



*“The technology of the L 860 makes you feel like there’s a teacher inside the machine.”*

**JULIAN COLLINS**, DESIGNER AKA "JULIAN CREATES"

Julian Collins is fascinated by the L 860 – and for good reason. Because the L 860 is the perfect overlocker for beginners and professionals alike. From easy looper threading with the One-step BERNINA Air Threader, to navigation on the large touch screen for an easy stitch selection, to the built-in needle threader and swing-out presser foot, the L 860 simplifies his entire sewing process. Like Julian, you’ll appreciate the Expert and Guided Modes to help you create your perfect stitch.

# BERNINA L 890



6-step presser foot pressure

Color Touch Screen with Guided Mode and Expert Mode

LED sewing light

Slide-on extension table

Workspace height  
3 3/8" (86 mm)

5 5/8" (143 mm) to the  
right of the needle

Freearm

Adjustment of knife position  
and stitch width

Knife on/off

Micro Thread Control (mtc)

Cut-offs bin



LEARN MORE ABOUT THE  
BERNINA L 890 AT [BERNINA.COM/L890](http://BERNINA.COM/L890)

**All settings on the screen:**

- Stitch selection with automatic thread tension, stitch length, and differential feed
- Access to your Personal Memory, Creative Sewing Consultant, tutorial, animations, settings assistance
- Programmable needle stop up/down

**Color-coded One-path Threading**

**One-step BERNINA Air Threader**

**BERNINA Free Hand System (FHS) –  
Knee lifter**

**Accessories in the threader cover**

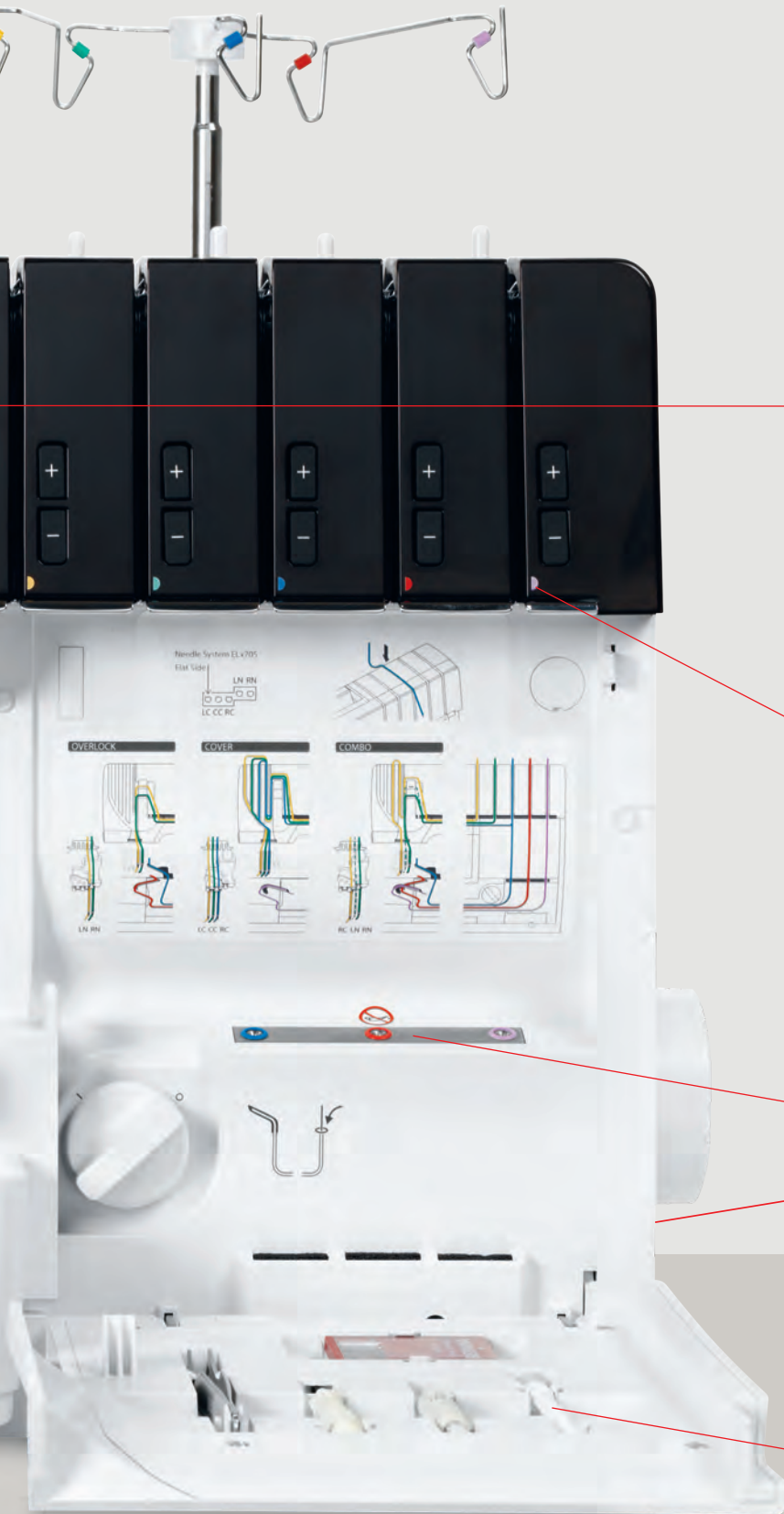

**BERNINA  
L 4 SERIES**

# **BERNINA L 460 AND L 450**

## **THE FAST AND THE FLEXIBLE WAY TO SEW!**

Working with the L 4 Series overlockers means saving time and stitching fast. Sewing projects take shape quickly and with little effort. Innovative features make BERNINA overlockers delightfully easy to use, ensuring professional quality down to the very last stitch.

### **EASE OF USE**

Settings are adjustable while sewing, including the thread tensions, the cutting width and the stitch length. Effortlessly change the differential feed to ensure wave-free seams in knits and no puckering in fine fabrics. A manual needle threader allows for easy and ergonomic threading. The color-coded threading paths as well as the lower looper threader support your quick threading.

### **ULTIMATE CONVENIENCE**

The well-lit, large workspace eases sewing as well as threading of loopers and needles. The L 460 also includes the BERNINA Free Hand System (FHS) that lowers and temporarily raises the presser foot, allowing both hands to be free for sewing and placing the fabric. The slide-on table expands the work space to support larger sewing projects (standard with the L 460, option available for the L 450).

### **MICRO THREAD CONTROL (mtc)**

Micro Thread Control (mtc) makes over-the-edge thread loops disappear with a quick flip of a lever. This saves time and effort while ensuring consistent high-quality stitches, professional seams and finished edges.



**BERNINA L 460**



**BERNINA L 450**

# PRODUCE SEAMS AND HEMS OF EXCELLENT STITCH QUALITY

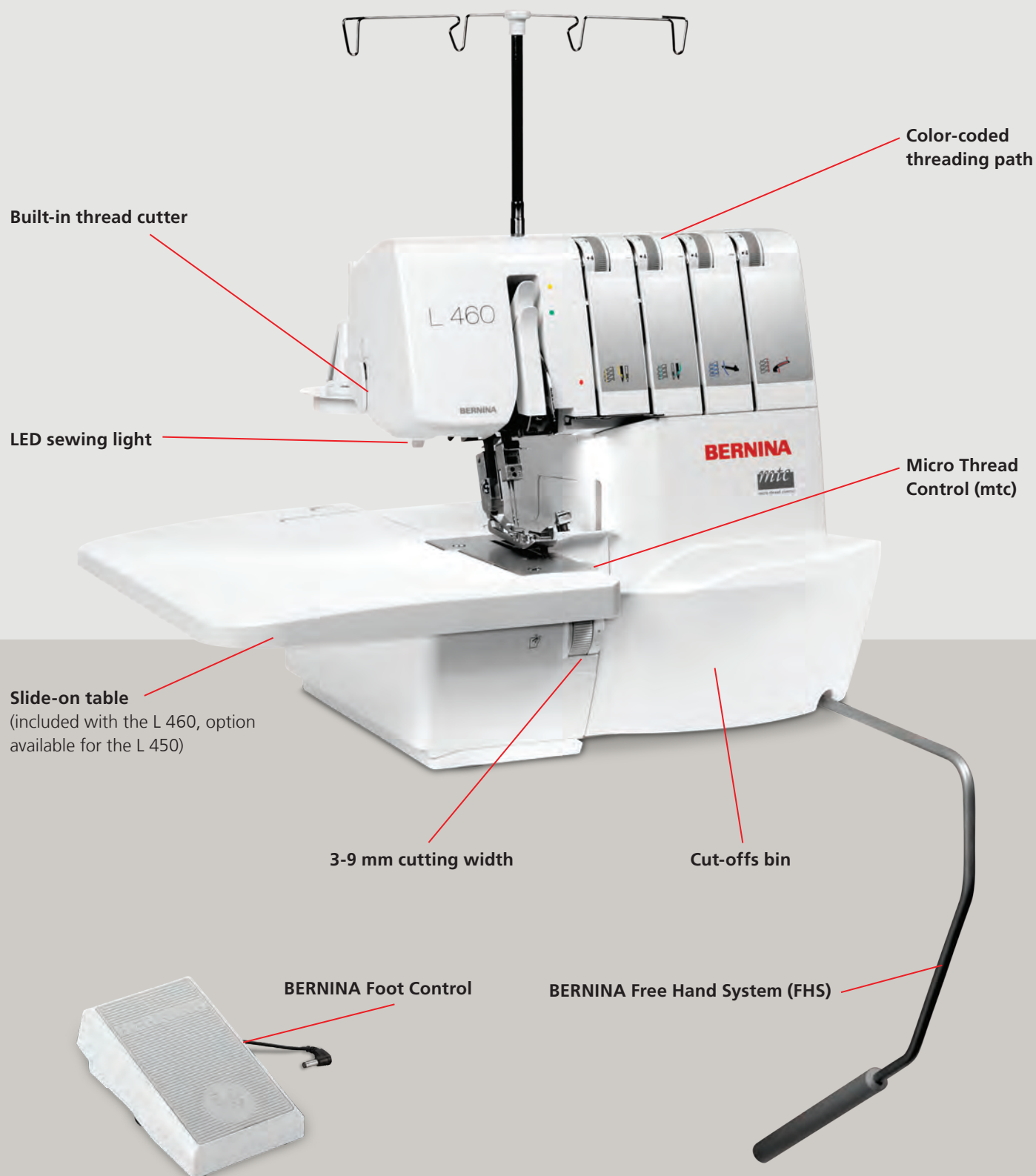

BERNINA  
Q24/Q20

# PROFESSIONAL AND MODERN: LONGARM QUILTING



*“Having the Q24 in my studio  
is a little slice of heaven.”*

**LISA HAGSTOZ CALLE, LONGARM QUILT ARTIST**

With a degree in Textile Management and Marketing, Lisa H. Calle soon began to explore the “other” side of textiles ... the artistic side. She fell in love with quilting in 1997 and discovered longarm quilting in 2004. Her award-winning original designs have opened the door to teaching opportunities so that others can learn from her art and skills.

## QUILT BIG

Carry out your large quilting projects with confidence and immerse yourself in the world of longarm quilting. Due to the simplicity of the machine and frame design this quilting system has the largest usable quilting space in its category. Select from a 20" or 24" platform to build the perfect system for home or studio.

The BERNINA Q20 comes standard as a sit-down model machine with a robust quilt table. The BERNINA Q24 is designed as a frame model machine and can only be used on the PRO Frames. The large freearm on both models offers a great deal of length and height, thus helping with big quilts.

Choose between:

- 20" sit-down model with quilt table
- 24" or 20" model with "Large" PRO Frame (12'11" / 3,93 m)
- 24" or 20" model with "Classic" PRO Frame (11'11" / 3,63 m)
- 24" or 20" model with "Small" PRO Frame (8'10" / 2,7 m)

## Q-MATIC: QUILTING WITH SOFTWARE

Teaming up with the innovative BERNINA Q24 and Q20 machines on Classic or Large PRO Frames, Q-matic fulfills your automated quilting needs in just a few simple steps. Whether stitching out simple edge-to-edge designs or intricate custom patterns, your way to an original masterpiece will be extremely easy.

The intuitive Q-matic Software interface helps you finish your quilt with ease. The 21.5" all-in-one touch screen PC mounted to the side of the frame guarantees convenient access to all designing and quilting features. For ease-of-use, additional interactive displays on the machine head screen allow control of design stitch-out and placement directly from the sewhead. Returning to the main screen is not necessary, making your quilting highly efficient.

**The Q-matic Kit is only available in selected markets.**

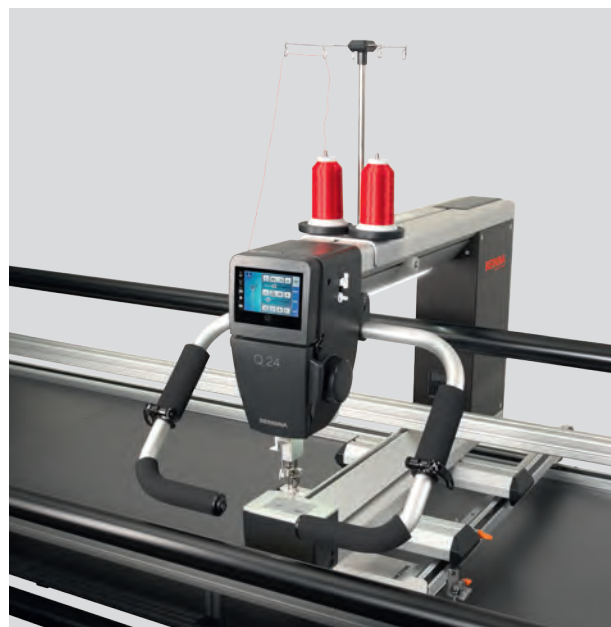

YOU'LL FIND MORE INFORMATION  
AT [BERNINA.COM/LONGARM](http://BERNINA.COM/LONGARM)

**BERNINA  
Q 16 PLUS / Q 16**

# TWO LONGARM MACHINES FOR ANY SIZE SPACE

Maneuvering a large quilt through the limited space of a household sewing machine can be a difficult task. But now we have the perfect solution for you! Introducing the BERNINA Q 16 and Q 16 PLUS – the longarm machines for quilters with big quilting dreams and limited space at home.

Both models have a throat space of 16.5", providing a larger work space than a sewing machine. In combination with a quilting table or a 5 ft or 10 ft modular BERNINA Studio Frame (Q 16 PLUS only), the BERNINA Q 16 and Q 16 PLUS fulfill all quilting expectations. The Q 16 PLUS on the 10 ft Studio Frame can also be upgraded with the Pantograph Kit and can be automated with Q-matic (both optional).



*“The perfect match for longarm lovers like me.”*

**AMANDA MURPHY, QUILT AND PATTERN DESIGNER**

Amanda Murphy has a passion for designing and creating quilts on her BERNINA Q 16 PLUS. While her studio is small, the roomy quilting space of the Q 16 PLUS genuinely enhances her creative process. Like Amanda, you'll appreciate the fast 2,200 stitches per minute as well as the three modes of the BERNINA Stitch Regulator.

- BERNINA QUALITY AT A GREAT VALUE
- SPACIOUS 16" WORKSPACE
- BUILT-IN BERNINA STITCH REGULATOR FOR IMPECCABLE STITCHES
- 5 ft OR 10 ft MODULAR STUDIO FRAME
- TABLE OR QUILT FRAME OPTIONS AVAILABLE

FOR MORE INFORMATION  
VISIT [BERNINA.COM/LONGARM](http://BERNINA.COM/LONGARM)



# YOUR DREAMS COME TRUE



## DESIGNERPLUS AND CREATOR WITH WIFI FUNCTIONALITY

BERNINA Embroidery Software 9 is the newly developed software with both the long time embroiderer and the BERNINA Software novice in mind. It opens the door to outstanding and creative embroidery and is available in two levels: **DesignerPlus** offers all the great new and incredible embroidery features for creatives, who want to design unique motifs.

Embroiderers who own previous versions can update their older BERNINA Embroidery Software to BERNINA Embroidery Software 9 to get all the great new features.

**Creator**, the second level, is the entry to embroidery, giving the upcoming embroiderer all the tools needed. You can use Creator to start your embroidery projects as well as edit and alter designs to create something personal and valuable to you. And if you're ready for it, you can easily upgrade from Creator to DesignerPlus any time.

BERNINA Embroidery Software 9 offers numerous new features designed to make creating embroidery fast, easy and rewarding. Both levels offer a variety of new options and possibilities, including WiFi functionality. This new feature requires the BERNINA WiFi Device, which is standard with DesignerPlus and an optional extra for Creator. Creating new designs has never been so easy. Embroidery has reached a new level!

DOWNLOAD THE FREE TRIAL VERSION  
OF BERNINA EMBROIDERY SOFTWARE 9  
FOR 30 DAYS AT [BERNINA.COM/V9](http://BERNINA.COM/V9)







FIND OUT MORE ABOUT  
BERNINA EMBROIDERY SOFTWARE 9  
AT [BERNINA.COM/SOFTWARE](https://www.bernina.com/software)



**“Finally I can create my most memorable designs.”**

**SUE O’VERY-PRUITT**, EMBROIDERY AND GARMENT DESIGNER  
AKA “SOOKIE SEWS”

Sue O’Very-Pruitt is not only a very creative person but also a real sewing and embroidery enthusiast from Florida, USA. As a costume and fashion designer she traveled the globe before she started running her own business in 2010 under the label “Sookie Sews”. Sue has been digitizing for over 25 years, designing creative embroidery embellishments. Now with the BERNINA Embroidery Software 9, she has found the software that matches her imagination.

# NEW FEATURES YOU'LL JUST LOVE



## EASY INSTALLATION / HOME SCREEN

The software can be installed on your computer in no time. You can also use the software on multiple computers by simply logging in and out on the different devices. You are first taken to an informative and interactive home screen that provides links to helpful tutorials, embroidery designs and new projects.



## WIFI FUNCTIONALITY

The BERNINA WiFi Connector allows embroidery designs to be transmitted wirelessly – from your computer to your embroidery machine! The BERNINA WiFi Device is included as standard with DesignerPlus and is available as an optional extra for Creator.

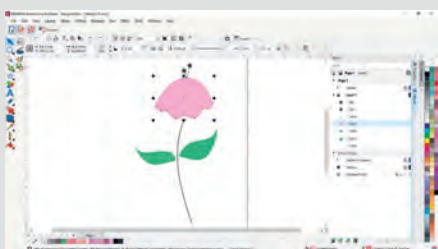

## CORELDRAW SE (DESIGNERPLUS)

If you wish to start with a new graphic, simply open the graphic program CorelDRAW SE, which is included with DesignerPlus, and get your own drawings in a breeze.

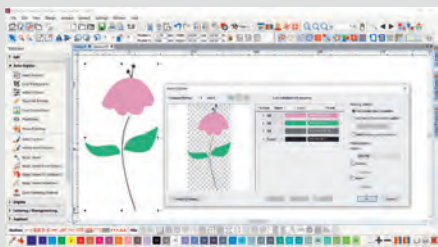

## AUTO-DIGITIZING AND MANUAL DIGITIZING

You can convert your own artwork (a drawing, sketch or photo) into an embroidery design using the enhanced automatic or manual digitizing tools. DesignerPlus also offers new features such as the Keyboard Design Collection, Quilt Design and Cross Stitch Design Application, Multi-Hooping, PunchWork and Couching.

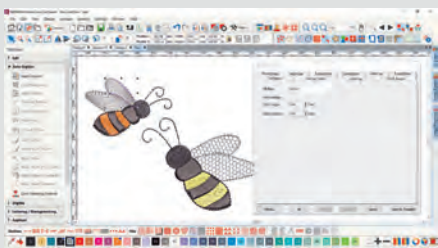

## FULL EDITING

You can add special fill effects to your design, and change colors or sizes. New features offer even more benefits! The Branching tool creates the most efficient embroidery sequence, and the Weld tool allows you to combine multiple objects into one.



## FONTS

BERNINA Embroidery Software 9 contains many new fonts, with a total of over 100 styles in all – including new modern handwritten-style fonts.

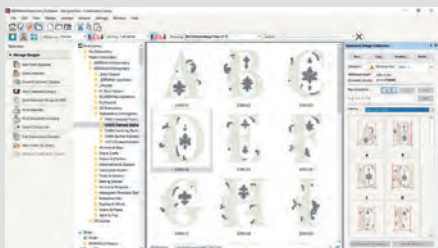

## KEYBOARD DESIGN COLLECTION

The choice of fonts can be expanded even further with the Keyboard Design Collection. With this versatile new function, letters or designs can be assigned to the keyboard to create additional fonts – you can even add your own handwriting.

# MANY MORE FEATURES TO ENJOY

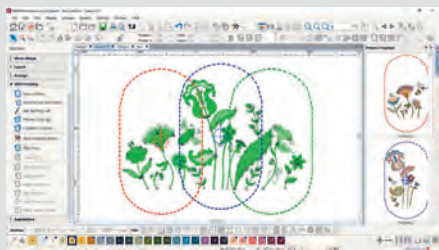

## MULTI-HOOPING

Creating large designs is simple using the Multi-Hooping feature which automatically places more than one hoop when necessary. It places hoops to cover the entire design, fitting as many objects as possible into each hoop position. You can preview all hooping sequences and save it as a complete design or as separate multi-hooping machine files.



## COLOR MANAGEMENT

Palette positions are numbered for easy reference within the Color Management system and the color wheel features a range of color options. It has never been easier to pick the right color and fill objects with the help of the numerous choices within the palette (56 + 3 appliqué). The chosen colors are tagged with a blue marker.

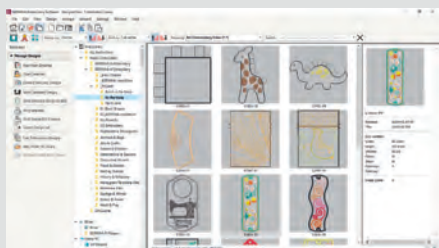

## INTEGRATED DESIGN LIBRARY

This powerful search engine ensures quick access to all designs and provides enhanced design management. It makes it easy to browse, group and search for designs or get inspired. From here you can also directly send your designs to the BERNINA WiFi Device for stitch-out.

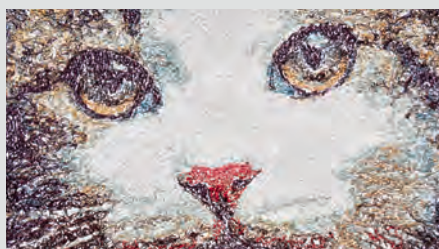

## 3D EMBROIDERY

The Color Photo Stitch and Automatic Digitizing features turn your favorite photo into a detailed embroidery design in just a few steps. With Puffy Lettering add outstanding 3D effects to embroidered letters and with the enhanced CutWork function create beautiful Eyelet Embroidery and Appliqué. The Globe Effect turns flat embroidery into a 3D design and with Couching, create stunning 3D effects with wool.

## AUTOMATED QUILT BLOCK LAYOUT

Embroidering on quilts is also easy with the Automated Quilt block layout feature. The automatic quilt background stitching is used to create "echo" quilting designs, like scroll-clipped or stipple-filled quilt blocks. And you get quilt block sizing and positioning aids.

## EASY POSITIONING

The positioning feature makes it easy to place designs where you want them. Just set the design worksheet and add a template to your preview, then move and rotate the design within the hoop and use the advanced print preview options. Use the hoop template and basting stitch markers for exact positioning.

## APPLIQUÉ

Enjoy the extensive tools to create appliqué and convert any shape into an appliqué design with just one click. Even creating appliqué with holes inside is now easily possible. Want to cut the fabric with the CutWork tool or a cutting machine? No problem as you can save an extra cutting file directly from the embroidery canvas.

## USER-FRIENDLY INTERFACE AND IMPROVED FEATURES

All the incredible software features are easy to use and navigate with the user-friendly interface. The menu is intuitive and easy to manage. You have the choice between small or large icons for a perfect view and the tool names and functions can be displayed if desired. It's possible to open more than one design at a time with easy switching between designs via the design tabs.

# FEATURE OVERVIEW

## OVERLOCKERS

Stitch Variations	L 890	L 860	L 850	L 460	L 450
Total number of stitches	27	18	18	16	16
4-thread overlock	1	1	1	1	1
3-thread overlock (wide/narrow)	2	2	2	2	2
3-thread super-stretch	1	1	1	1	1
3-thread flatlock (wide/narrow)	2	2	2	2	2
3-thread narrow seam	1	1	1	1	1
3-thread rolled hem	1	1	1	1	1
3-thread picot stitch	1	1	1	1	1
2-thread overlock (wide/narrow)	2	2	2	2	2
2-thread flatlock (wide/narrow)	2	2	2	2	2
2-thread rolled hem	1	1	1	1	1
2-thread wrapped overlock (wide/narrow)	2	2	2	2	2
2-thread blanket stitch (wide/narrow)	2	2	2	–	–
4-thread coverstitch	1	–	–	–	–
3-thread coverstitch (wide/narrow)	3	–	–	–	–
2-thread chainstitch	1	–	–	–	–
Chainstitch with 3-thread overlock (wide/narrow)	2	–	–	–	–
Chainstitch with 2-thread overlock (wide/narrow)	2	–	–	–	–

Comfort Features	L 890	L 860	L 850	L 460	L 450
One-step BERNINA Air Threader (for looper threads)	✓	✓	✓	–	–
Lower looper threader	–	–	–	✓	✓
Color touch screen	✓	✓	–	–	–
Expert Mode and Guided Mode	✓	✓	–	–	–
Stitch selection / Settings on the screen	✓	✓	–	–	–
Personal Memory for 100 individual stitches	✓	✓	–	–	–
Helpful animations and tutorials	✓	✓	–	–	–
Creative Consultant	✓	✓	–	–	–
Stitch Optimizer	✓	✓	–	–	–
Freearm	✓	✓	✓	–	–
Sewing space to the right of the needle	5 5/8" / 143 mm	5 5/8" / 143 mm	5 5/8" / 143 mm	2" / 50 mm	2" / 50 mm
Workspace height	3 3/8" / 86 mm	3 3/8" / 86 mm	3 3/8" / 86 mm	1 1/2" / 40 mm	1 1/2" / 40 mm
Swing-out presser foot with auto swing back	✓	✓	✓	–	–
Built-in needle threader	–	✓	✓	–	–
One-path threading, color-coded	✓	✓	✓	✓	✓
Automatic needle stop up	✓	✓	✓	✓	–
Needle stop up/down programmable	✓	✓	–	–	–
Needle up/down with BERNINA Foot Control	✓	✓	✓	✓	–
Thread tension release when presser foot raised	✓	✓	✓	✓	✓
Stitch-by-stitch sewing	✓	✓	✓	✓	–
Stitch length fine tuning for rolled hem	✓	✓	✓	✓	✓
Adjustable stitch length while sewing	✓	✓	✓	✓	✓
Adjustable differential feed while sewing	✓	✓	✓	✓	✓
Thread tension adjustable while sewing	✓	✓	✓	✓	✓
Adjustable cutting width while sewing	✓	✓	✓	✓	✓
Integrated upper looper converter	✓	✓	✓	–	–
Accessories in the threader cover	✓	✓	✓	✓	✓
LED sewing light	✓	✓	✓	✓	✓
Safety switch for open cover and raised presser foot	✓	✓	✓	✓	–

<b>Technical Specifications</b>	<b>L 890</b>	<b>L 860</b>	<b>L 850</b>	<b>L 460</b>	<b>L 450</b>
Micro Thread Control (mtc)	✓	✓	✓	✓	✓
Overlock stitch width 3-9 mm	✓	✓	✓	✓	✓
Coverstitch width 3/6mm	✓	-	-	-	-
Combo stitches width 7-11mm	✓	-	-	-	-
2-step presser foot lifter with front-foot-lift	✓	✓	✓	✓	✓
Adjustable presser foot pressure	6 steps	6 steps	6 steps	5 steps	5 steps
Rolled hem lever integrated under stitch plate	✓	✓	✓	✓	✓
Easy to engage and disengage the knife from outside	✓	✓	✓	-	-
Motor	DC	DC	DC	DC	AC
Maximum sewing speed (stitches per minute)	1,350	1,500	1,500	1,500	1,200
Weight of machine	29,5 lbs / 13,4 kg	28.8 lbs / 13,1 kg	27,1 lbs / 12,3 kg	21,6 lbs / 9,8 kg	18,1 lbs / 8,2 kg

<b>Standard Accessories</b>	<b>L 890</b>	<b>L 860</b>	<b>L 850</b>	<b>L 460</b>	<b>L 450</b>
Standard Overlock Foot (with Tape Guide)	-	-	-	✓	✓
Standard Overlock Foot #L10 (with Tape Guide)	-	✓	✓	-	-
Overlock/Combostitch Foot #C11	✓	-	-	-	-
Cover/Chainstitch Foot #C13	✓	-	-	-	-
BERNINA Free Hand System (FHS) with knee lifter	✓	✓	✓	✓	-
Slide-on extension table	✓	✓	✓	✓	optional
Freearm cover	✓	✓	optional	-	-
Coverstitch cover	✓	-	-	-	-
Upper looper converter	✓	✓	✓	✓	✓
Manual needle threader/insertor	✓	✓	✓	✓	✓
Thread cutter	✓	✓	✓	✓	✓
Cut-offs bin	✓	✓	✓	✓	✓
Right seam guide	✓	✓	✓	✓	✓
Set of needles	✓	✓	✓	✓	✓
Tools and accessories in separate box	✓	✓	✓	✓	✓
Dust cover	✓	✓	✓	✓	✓

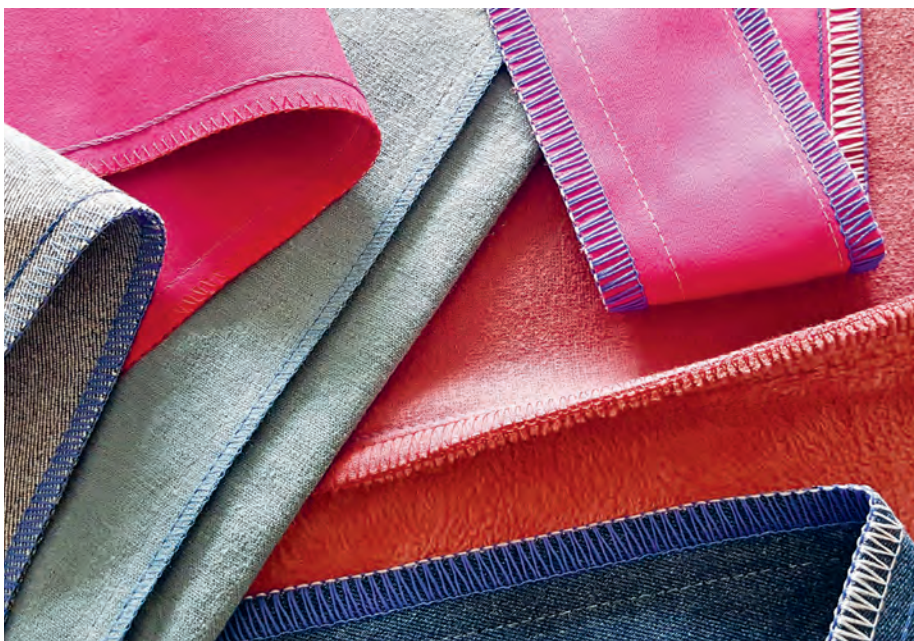

# FEATURE OVERVIEW

## SEWING MACHINES

	General																												
	Hook system*	Color touch screen	Space to the right of the needle, in mm	Sewing light	Weight of the machine, in kg	Needle positions	Sewing in each needle position	Maximum stitch width in mm	Maximum stitch length in mm	Multi-function knobs	Changing stitch settings while sewing	Start/stop button (stitching without foot control)	Speed control	Programmable BERNINA Foot Control (with back-kick function on some models)	Built-in needle threader	Automatic needle threader	Automatic presser foot pressure	Presser foot hover feature	Upper-thread sensor	Lower-thread sensor	Automatic thread sensor	Manual thread cutter	Needle stop up/down	Drag & Drop	Bobbin winding while sewing/embroidering	BERNINA Dual Feed	BERNINA Adaptive Thread Tension	BSR-enabled	
<b>B 880 PLUS</b>	RL	✓ <sup>1</sup>	300	LED	16	11	✓	9	6	✓	✓	✓	✓	✓	✓	✓	✓	✓	✓	✓	✓	✓	✓	✓	✓	✓	✓	✓	✓
<b>B 790 PLUS</b>	B	✓ <sup>1</sup>	254	LED	14	11	✓	9	6	✓	✓	✓	✓	✓	✓	✓	✓	✓	✓	✓	✓	✓	✓	✓	✓	✓	✓	✓	✓
<b>B 770 QE PLUS</b>	B	✓ <sup>1</sup>	254	LED	14	11	✓	9	6	✓	✓	✓	✓	✓	✓	✓	✓	✓	✓	✓	✓	✓	✓	✓	✓	✓	✓	✓ <sup>3</sup>	✓
<b>B 735</b>	B	✓ <sup>1</sup>	254	LED	14	11	✓	5,5	6	✓	✓	✓	✓	✓	✓	✓	✓	✓	✓	✓	✓	✓	✓	✓	✓	✓	✓	✓	✓
<b>B 700</b>	B	✓ <sup>1</sup>	254	LED	14	-	-	-	-	✓	-	✓	✓	-	Opt.	✓	-	-	✓	-	✓	✓	✓	✓	✓	✓	✓	✓	✓
<b>B 590</b>	B	✓ <sup>2</sup>	215	LED	11	11	✓	9	6	✓	✓	✓	✓	✓	✓	✓	✓	✓	✓	✓	✓	✓	✓	✓	✓	✓	✓	✓	✓
<b>B 570 QE</b>	B	✓ <sup>2</sup>	215	LED	11	11	✓	9	6	✓	✓	✓	✓	✓	✓	✓	✓	✓	✓	✓	✓	✓	✓	✓	✓	✓	✓	✓	✓
<b>B 535</b>	B	✓ <sup>2</sup>	215	LED	11	11	✓	5,5	6	✓	✓	✓	✓	✓	✓	✓	✓	✓	✓	✓	✓	✓	✓	✓	✓	✓	✓	✓	✓
<b>B 500</b>	B	✓ <sup>2</sup>	215	LED	11	-	-	-	-	✓	-	✓	✓	-	Opt.	✓	-	-	✓	-	✓	✓	✓	✓	✓	✓	✓	✓	✓
<b>B 480</b>	B	✓ <sup>2</sup>	177.7	LED	9.5	11	✓	9	6	✓	✓	✓	✓	✓	✓	✓	✓	✓	✓	✓	✓	✓	✓	✓	✓	✓	✓	✓	✓
<b>B 475 QE</b>	B	✓ <sup>2</sup>	177.7	LED	9.5	11	✓	5,5	6	✓	✓	✓	✓	✓	✓	✓	✓	✓	✓	✓	✓	✓	✓	✓	✓	✓	✓	✓	✓
<b>B 435</b>	B	✓ <sup>2</sup>	177.7	LED	9.5	11	✓	5,5	6	✓	✓	✓	✓	✓	✓	✓	✓	✓	✓	✓	✓	✓	✓	✓	✓	✓	✓	✓	✓
<b>B 335</b>	CB	-	160	LED	8	9	✓	5,5	5	-	✓	✓	✓	-	✓	✓	-	-	-	-	-	✓	✓	-	✓	-	-	-	
<b>B 325</b>	CB	-	160	LED	8	9	✓	5,5	5	-	✓	✓	✓	-	✓	✓	-	-	-	-	-	✓	✓	-	✓	-	-	-	

\* RL = Rotary Hook  
 B = BERNINA Hook  
 CB = CB Hook (central bobbin)

<sup>1</sup> 7-inch (17cm) TFT screen  
<sup>2</sup> 4.3-inch (10cm) TFT screen

<sup>3</sup> Includes BSR 3 Mode (basting) and KickStart

## Sewing and Quilting

On-screen help	Sewing tutorial	Embroidery tutorial	Creative Consultant	Embroidery Consultant	Personal memory	Memory	History function (most recently used stitch patterns)	USB interface for PC connection	USB interface for USB data stick	Setup program	Language selection	Alarm clock	Eco mode	Maximum sewing speed (stitches per minute)	Mirror Image	Directional sewing 360°	Distortion	Sideways motion	Pattern start/end function	Connecting stitches	Pattern elongation	Safety function	Programmable securing function	Stitch Designer	Triple Stitch Function	Total number of sewing stitch patterns (incl. alphabet)	Utility stitches	Buttonhole types	Automatic buttonhole (incl. eyelet types)	Manual multistep buttonhole	Button sew-on program	Darning programs	Decorative stitches	Decorative sideways	Quilting	
✓	✓	✓	✓	✓	✓	✓	✓	✓	✓	✓	✓	✓	1,200	✓	✓	✓	✓	✓	✓	✓	✓	✓	✓	✓	–	1,764	38	19	✓	✓	✓	3	630	109	66	
✓	✓	✓	✓	✓	✓	✓	✓	✓	✓	✓	–	✓	1,000	✓	✓	–	✓	✓	✓	✓	✓	✓	✓	–	1,352	32	15	✓	✓	✓	2	506	117	34		
✓	✓	✓	✓	–	✓	✓	✓	✓	✓	✓	–	✓	1,000	✓	–	–	–	✓	–	✓	✓	✓	–	✓	1,809	38	18	✓	✓	✓	2	500	–	74		
✓	✓	✓	✓	✓	✓	✓	✓	✓	✓	✓	–	✓	1,000	✓	–	–	–	✓	–	✓	✓	✓	–	✓	1,255	32	15	✓	✓	✓	2	350	–	29		
✓	–	✓	–	✓	–	✓	–	✓	✓	✓	–	✓																								
✓	✓	✓	✓	✓	✓	✓	–	✓	✓	✓	–	✓	1,000	✓	–	–	–	✓	–	✓	✓	–	–	✓	1,774	38	18	✓	✓	✓	2	500	–	59		
✓	✓	✓	✓	–	✓	✓	–	✓	✓	✓	–	✓	1,000	✓	–	–	–	✓	–	✓	✓	–	–	✓	1,450	34	16	✓	✓	✓	2	450	–	73		
✓	✓	✓	✓	–	✓	✓	–	✓	✓	✓	–	✓	1,000	✓	–	–	–	✓	–	–	✓	✓	–	–	1,048	30	14	✓	✓	✓	2	300	–	44		
✓	–	✓	–	✓	–	✓	–	✓	✓	✓	–	✓																								
✓	✓	–	✓	–	✓	✓	–	✓	✓	✓	–	✓	900	✓	–	–	–	✓	–	✓	✓	✓	–	–	994	29	11	✓	✓	✓	2	250	–	27		
✓	✓	–	✓	–	✓	✓	–	✓	✓	✓	–	✓	900	✓	–	–	–	✓	–	–	✓	✓	–	–	840	29	10	✓ <sup>10</sup>	✓	✓	2	200	–	40		
✓	✓	–	✓	–	✓	✓	–	✓	✓	✓	–	✓	900	✓	–	–	–	✓	–	–	✓	–	–	–	650	29	9	✓ <sup>10</sup>	✓	✓	2	150	–	13		
–	–	–	–	–	✓	–	–	–	–	–	–	–	900	✓	–	–	–	✓/–	–	–	–	–	–	–	221	20	5	✓	✓	✓	1	91	–	12		
–	–	–	–	–	✓	–	–	–	–	–	–	–	900	–	–	–	–	✓/–	–	–	–	–	–	–	97	15	1	✓ <sup>10</sup>	✓	✓	1	23	–	3		

										Embroidery <sup>5</sup>																						
Stitching stitches	Cross-stitch programs	Tassel/tapering/skyline stitch patterns	Sewing alphabets <sup>4</sup>	Monograms (with sideways motion only)	Maximum embroidery speed (stitches per minute)	Large embroidery speed (SDI) (maximum)	Medium embroidery speed (SDI) (maximum)	Built-in embroidery designs	Embroidery alphabets	Embroidery design format	Midi Hoop functionality	Mega Hoop functionality	Maxi Hoop functionality	Jumbo Hoop functionality	Freearm embroidery	On-screen design editing – mirror, rotate, skew	Combining designs	Personal memory for saving embroidery designs	Standard embroidery hoops <sup>8</sup>	WordART	Shape Designer	Embroidering sewing stitches	Color resequencing	Color Wheel	Pinpoint Placement	Group/Ungroup	Undo/Redo	Invisible Secure	Smart Secure	Thread-Up Command		
31	81	11	✓	1,000	✓	–	462	21	EXP, DST, PES, PEC, JEF, SEW, PCS, XXX	✓	✓	✓	✓	✓	✓	✓	✓	3 (o,m,s)	✓	✓	✓	✓	✓	✓	✓	✓	✓	✓	✓	✓	B 880 PLUS	
37	52	8	✓	1,000	✓ <sup>6</sup>	–	332	18		✓	✓	✓	✓ <sup>7</sup>	✓	✓	✓	✓	✓	3 (o,m,s)	✓	–	✓	✓	✓	✓	✓	✓	✓	✓	✓	B 790 PLUS	
20	–	9	–	1,000	Opt. <sup>6</sup>	–	275	8		✓	✓	✓	✓ <sup>7</sup>	✓	✓	✓	✓	✓	3 (o,m,s)	✓	–	–	✓	–	✓ <sup>9</sup>	✓	–	✓	✓	✓	B 770 QE PLUS	
14	–	6	–	1,000	Opt. <sup>6</sup>	–	250	6		✓	✓	✓	✓ <sup>7</sup>	✓	✓	✓	✓	✓	3 (o,m,s)	–	–	–	✓	–	✓ <sup>9</sup>	✓	–	✓	✓	✓	B 735	
				1,000	✓ <sup>6</sup>	–	320	18		✓	✓	✓	✓ <sup>7</sup>	✓	✓	✓	✓	✓	✓	3 (o,m,s)	✓	–	–	✓	–	✓	✓	✓	✓	✓	✓	B 700
40	–	9	–	1,000	–	✓	275	8		✓	✓	–	–	✓	✓	✓	✓	✓	2 (o,m)	✓	–	✓	✓	✓	✓	✓	✓	✓	✓	✓	✓	B 590
34	–	8	–	1,000	–	Opt.	250	7		✓	✓	–	–	✓	✓	✓	✓	✓	2 (o,m)	✓	–	–	✓	–	–	–	–	–	✓	✓	✓	B 570 QE
31	–	5	–	1,000	–	Opt.	50	4		✓	✓	–	–	✓	✓	✓	✓	✓	2 (o,m)	✓	–	–	✓	–	–	–	–	–	✓	✓	✓	B 535
				1,000	–	✓	275	8		✓	✓	–	–	✓	✓	✓	✓	✓	2 (o,m)	✓	–	–	✓	✓	✓	✓	✓	✓	✓	✓	✓	B 500
21	–	5	–	No embroidery function										B 480																		
13	–	4	–	No embroidery function										B 475 QE																		
11	–	3	–	No embroidery function										B 435																		
4	–	2	–	No embroidery function										B 335																		
3	–	1	–	No embroidery function										B 325																		

<sup>4</sup> The Cyrillic and Japanese alphabets are included on some models.

<sup>5</sup> Models with an embroidery function need an additional embroidery module for embroidery purposes, which is not included in the standard delivery in all countries.

<sup>6</sup> Limited embroidery area 400×210 mm (15.7"×8.3")

<sup>7</sup> Limited embroidery field 400×210 mm (15.7"×8.3")

<sup>8</sup> Large Oval = 255×145 mm (10.0"×5.7"), medium = 130×100 mm (5.1"×3.9"), small = 72×50 mm (2.8"×2")

<sup>9</sup> Including lock function





# YOU CAN GET „INSPIRATION“ ONLINE!

Find all sorts of great sewing ideas at [www.inspiration.bernina.com](http://www.inspiration.bernina.com)!

There, you can find great patterns and instructions for women's and children's fashion as well as accessories and home decorations to download. The magazine is now also available as an e-magazine! Visit us and sign up for the newsletter to make sure you don't miss anything !

Issues available as an e-magazine



Individual patterns

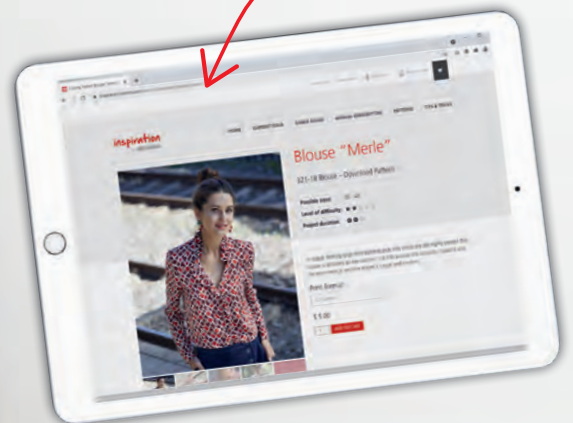

LOOKING FOR  
A NEW SEWING  
PROJECT?

[inspiration.bernina.com](http://www.inspiration.bernina.com)



made to create **BERNINA**