

OFFICE GLASS DOOR HARDWARE



Magnificent
MARKETING

• DIRECT IMPORTER • WHOLESALER • RETAILER

Your Builders'
Hardware Partner

ADDRESS: 531 T.ALONZO ST., STA. CRUZ
MANILA

HOURS: MONDAY-SATURDAYS,
8AM - 5PM

CONTACT: 8 - 733 5738 ; 7 - 000 5295

EMAIL: magnificenthardware@gmail.com

WEBSITE: www.magnificenthardware.com

FACEBOOK: @magnificentmarketing

VIBER: 0936 979 2353

GLASS DOOR ACCESSORIES

GLASS PATCH DOOR FITTING

Material: Stainless Steel 304
 Finish: Mirror/Stain
 Suitable for left & right hand door
 Glass Thickness: 10-12mm
 Available for: Toughened Glass Door

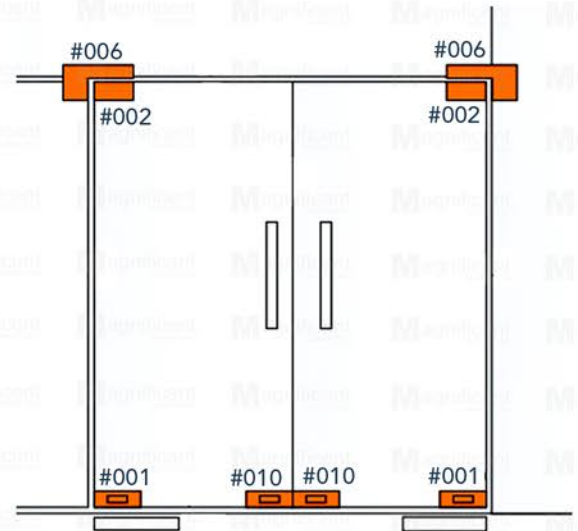

#001 - BOTTOM PATCH

Lower Clamp

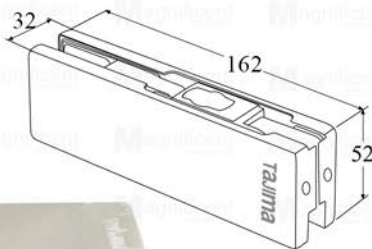

#002 - TOP PATCH

Upper Clamp

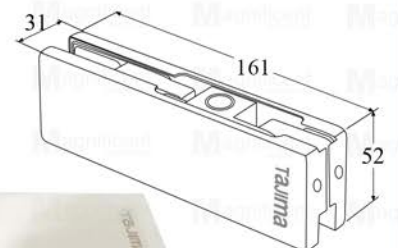

#006 - CORNER PATCH

Crank Clamp

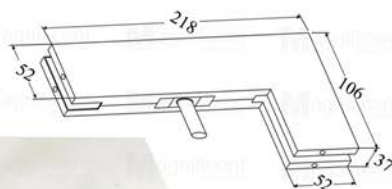

#010 - PATCH LOCK

Locking Clamp

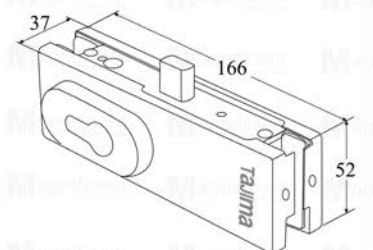

Tajima

GLASS DOOR ACCESSORIES

#4003

FLOOR HINGE SPRING FITTING

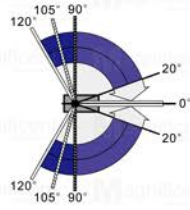

Information

Width of door max (mm) 650-950

Weight of door max (kg) 120

Weight of body (kg) 7.66

Dimension:

Length 310

Width 124

Height 58

Passed durability test 500,000 Cycles



90° 90 DEGREE HOLD OPEN

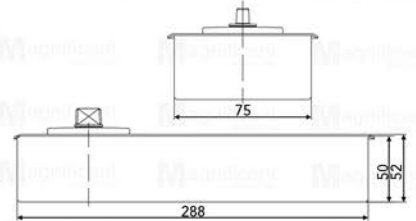
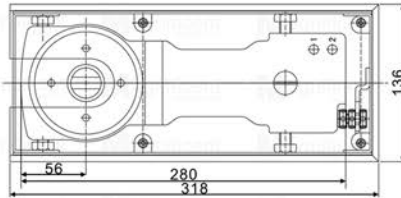

Tajima

GLASS DOOR LOCKS

#65

FRAMELESS GLASS
DOUBLE LOCK

- Material: Stainless
- Application: Single or double
- Glass thickness: 10mm-12mm
- Type: Keyed
- No glass cutout required
- Can be used for both sliding or swing doors

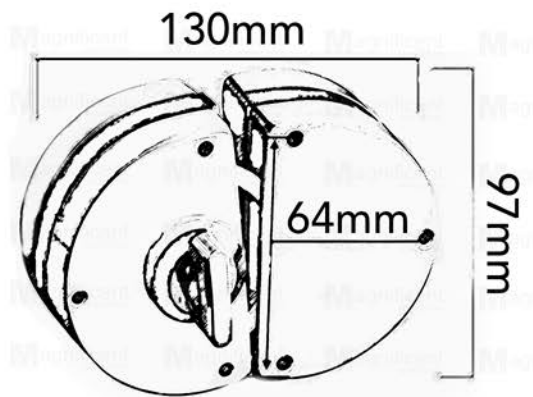

Wall-to-Glass Install (Single)

Glass-to-Glass Install (Double)



Tajima

GLASS DOOR LOCKS

#1102

FRAMELESS GLASS LOCK



Wall-to-Glass Install (Single)



Glass-to-Glass Install (Double)



FEATURES:

- Material: Stainless
- Application: Single or double
- Glass thickness: 10mm-12mm
- Type: Latch/Bolt only
- No glass cutout required
- Various mounting positions are available

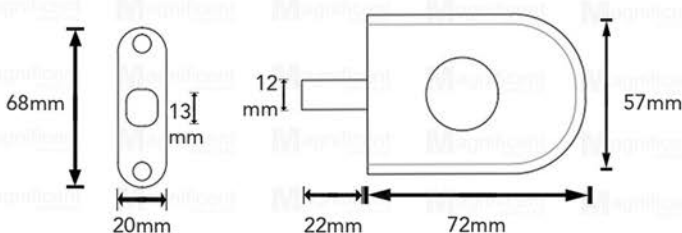
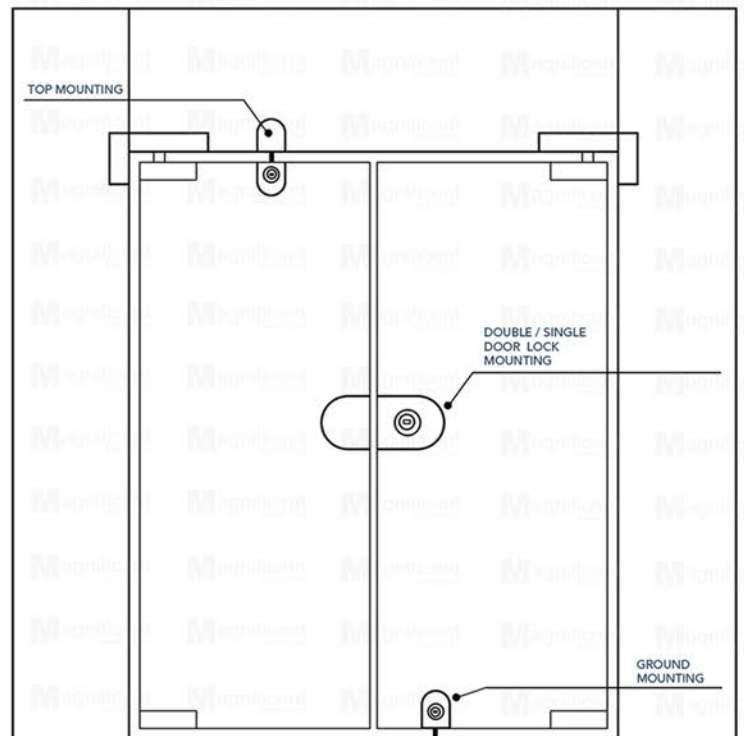

Tajima

GLASS DOOR LOCKS

#H109

STAINLESS STEEL ROUND HANDLE

- Material: Stainless Steel
- Finish: Chrome Plated
- Screws included

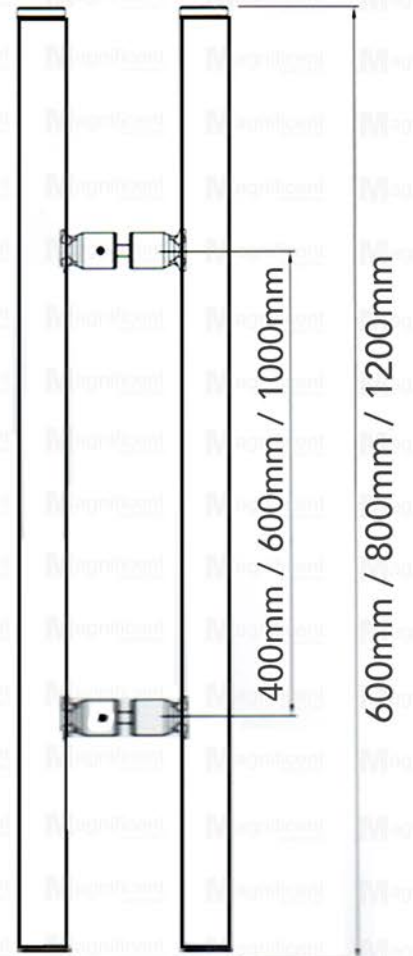
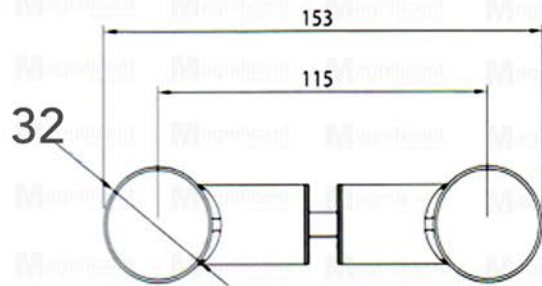

Tajima

GLASS DOOR LOCKS

#926

STAINLESS STEEL SQUARE HANDLE



- Material: Stainless Steel
- Finish: Black Powder Coated Stainless Steel
- Screws included

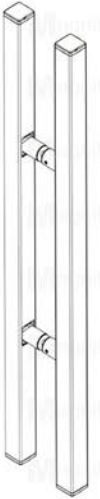
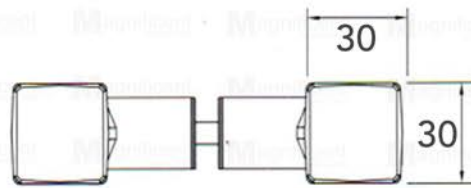

Tajima