

7 A.M.[®]
ENFANT
PARIS
NEW YORK

User Manual
VELVETPOD

User Manual

VELVETPOD

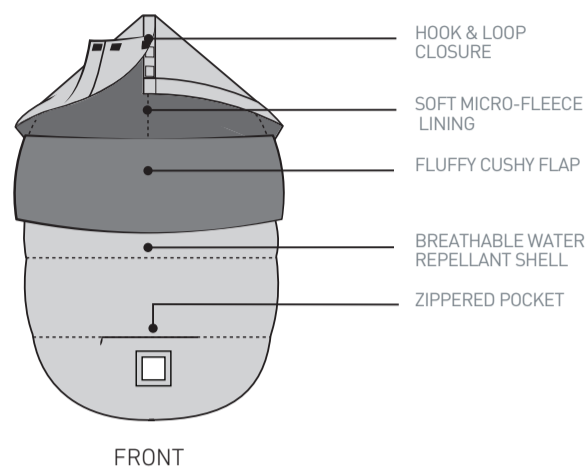

FRONT

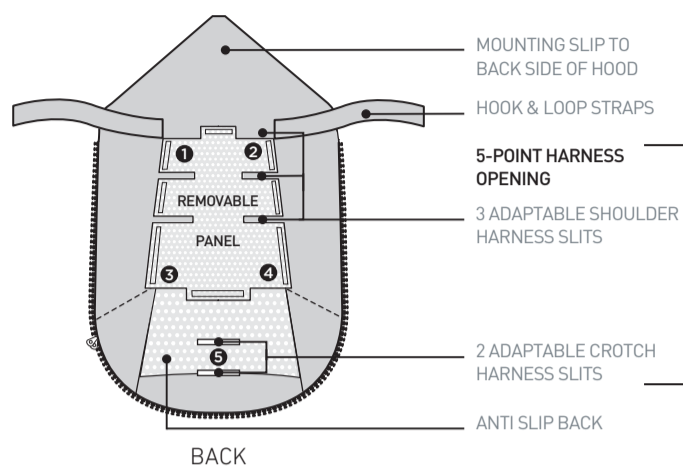

BACK

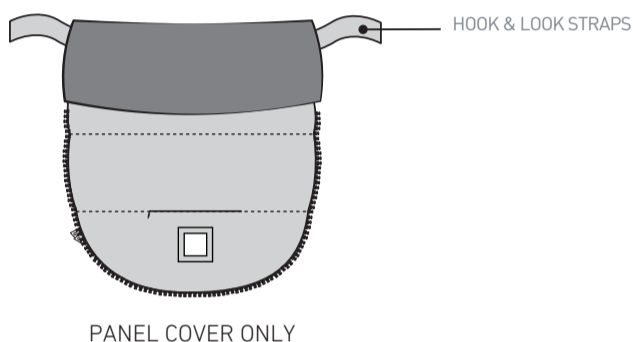

PANEL COVER ONLY

HOW TO USE ON STROLLER

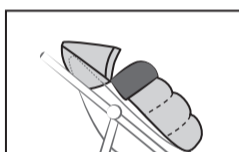
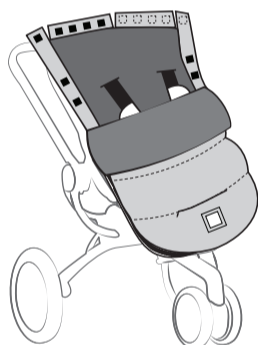

- 1 Place the VelvetPOD onto the stroller.
- 2 Optional: Slip the pouch located behind the hood over the top of the stroller to secure the VelvetPOD's stability.

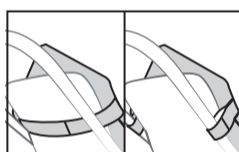

- 3 Use the hook & loop straps located on the sides of the VelvetPOD to attach to the stroller's back or sidebars in order to secure it.
- 4 Unzip the VelvetPOD cover.

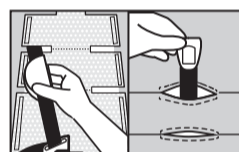

- 5 Pull the stroller's 5-point harness through the opening slits located on the back of the VelvetPOD by choosing the height of the slits corresponding to your child's size.
- 6 Seat your child on the VelvetPOD in the stroller and fasten the safety harness as per manufacturer's instructions.

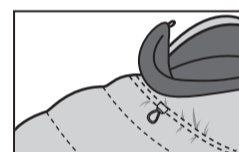

- 7 Zip the VelvetPOD cover up and adjust the snugness using the elastic drawstring located underneath the top flap to create a smaller enclosure around your child's face.
- 8 To further envelop your child's head, connect the side flaps to the hood with the hook & loop fasteners.

HOW TO USE ON CARSEAT

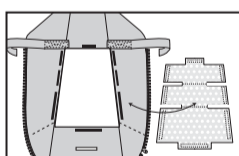
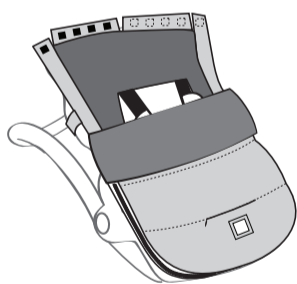

- 1 Detach the removable back panel to reveal the large back opening and to eliminate material between your baby's back and the car seat. Store it for stroller use.

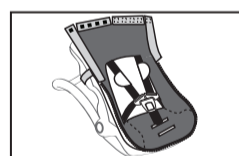

- 2 Place the VelvetPOD onto the car seat and unzip the front panel to open the VelvetPOD.
- 3 Pull the car seat's 5-point harness through the large back opening.



- 4 Seat your child on the VelvetPOD in the car seat and fasten the safety harness as per manufacturer's instructions.
- 5 Zip the VelvetPOD cover up.

HOW TO ONLY USE FRONT PANEL COVER

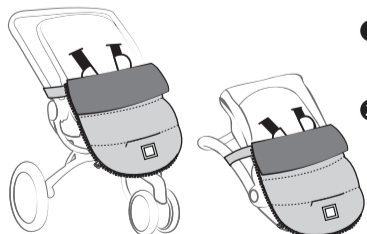

On Stroller

On Car Seat

- 1 Seat your child in the stroller or car seat and fasten the safety harness as per their manufacturer's instructions.
- 2 Unzip the front panel cover. Save the VelvetPOD's back for later use.

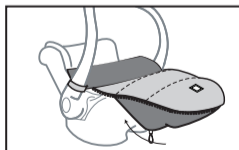

- 3 Slip the front panel's inner bottom pouch over the bottom of the stroller or car seat to secure the cover.

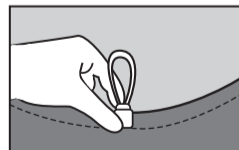

- 4 Pull the elastic drawstring under the pouch to adjust tightness.

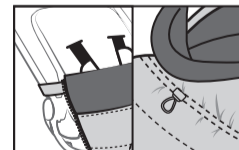

- 5 Use the hook & loop straps located on the sides of the front panel cover to attach to sidebars.
- 6 Use the elastic drawstring located underneath the top flap to adjust the snugness.

The VelvetPOD is machine washable. The care label is located on the back side of the product.

WARNING: Never leave child unattended in this product. Make sure that the child's face is not covered by any part of this product. Child should never be placed face-down in this product. Do not use this product as sleepwear or bedding. The child should not put buttons, plastic ends, snaps or other parts of this product into her/his mouth. Always use care when using zippers to avoid injury to the child. Failure to follow any warning may result in death or serious injury to the child. 7AM does not hold itself liable for any injury.