

**7 A.M.<sup>®</sup>**  
**ENFANT**  
P A R I S  
N E W Y O R K

**User Manual**  
**WAXEDPOD**

# User Manual

## WAXEDPOD

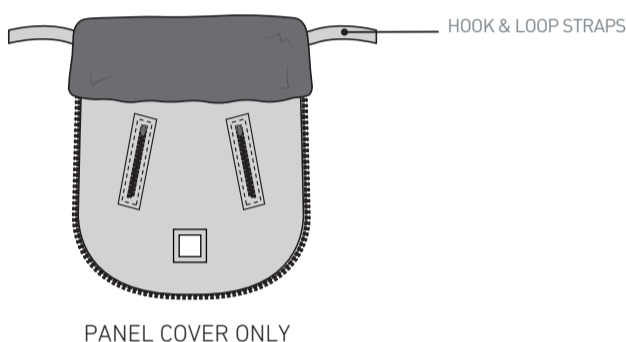
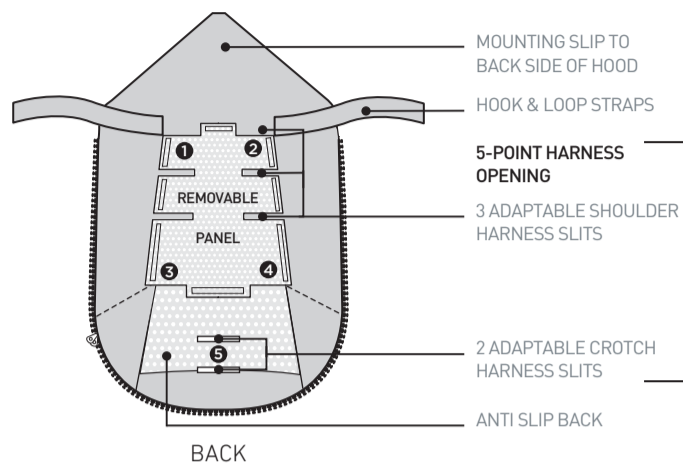
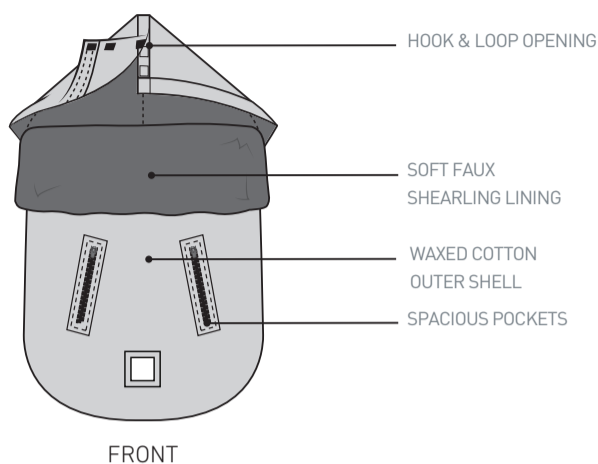

### HOW TO USE ON STROLLER

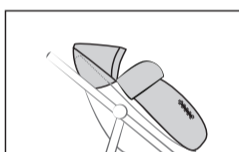
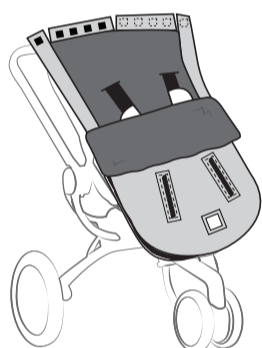

- 1 Place the WaxedPod onto the stroller.
- 2 Optional: Put integrated mounting slip on back side of hood over the top of the stroller seat to prevent footmuff from slipping.

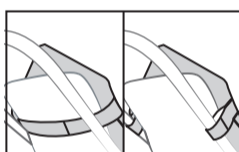

- 3 Use the hook & loop straps located on the sides of the WaxedPod to attach to the stroller's back or sidebars in order to secure it.
- 4 Unzip the WaxedPod cover.

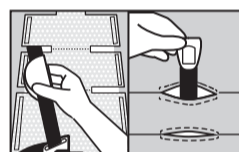

- 5 Pull the stroller's 5-point harness through the opening slits located on the back of the WaxedPod by choosing the height of the slits corresponding to your child's size.
- 6 Seat your child on the WaxedPod in the stroller and fasten the safety harness as per manufacturer's instructions.

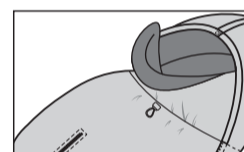

- 7 Zip the WaxedPod cover up and adjust the snugness using the elastic drawstring located underneath the top flap to create a smaller enclosure around your child's face.
- 8 To further envelop your child's head, connect the side flaps to the hood with the hook & loop fasteners.

### HOW TO USE ON CARSEAT

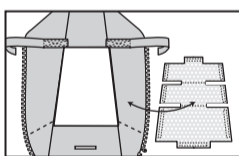
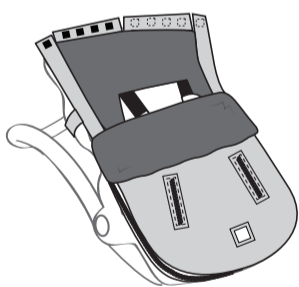

- 1 Detach the removable back panel to reveal the large back opening and to eliminate material between your baby's back and the car seat. Store it for stroller use.

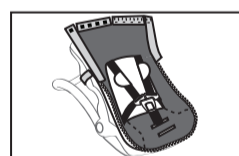

- 2 Place the WaxedPod onto the car seat and unzip the front panel to open the WaxedPod.
- 3 Pull the car seat's 5-point harness through the large back opening.



- 4 Seat your child on the WaxedPod in the car seat and fasten the safety harness as per manufacturer's instructions.
- 5 Zip the WaxedPod cover up.

### HOW TO ONLY USE FRONT PANEL COVER

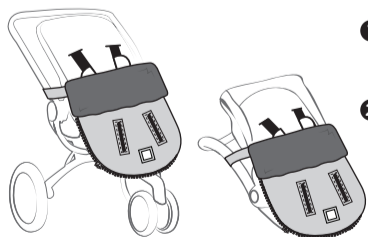

- 1 Seat your child in the stroller or car seat and fasten the safety harness as per their manufacturer's instructions.
- 2 Unzip the front panel cover. Save the WaxedPod's back for later use.

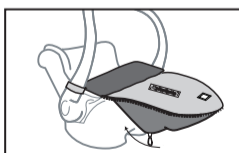

- 3 Slip the front panel's inner bottom pouch over the bottom of the stroller or car seat to secure the cover.

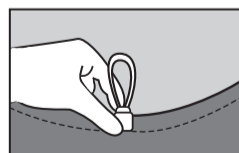

- 4 Pull the elastic drawstring under the pouch to adjust tightness.

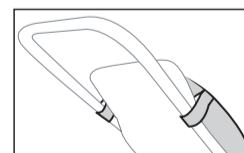

- 5 Use the hook & loop straps located on the sides of the front panel cover to attach to sidebars.
- 6 Use the elastic drawstring located underneath the top flap to adjust the snugness.

The PlushPOD is machine washable. The care label is located on the back side of the product.

**WARNING:** Never leave child unattended in this product. Make sure that the child's face is not covered by any part of this product. Child should never be placed face-down in this product. Do not use this product as sleepwear or bedding. The child should not put buttons, plastic ends, snaps or other parts of this product into her/his mouth. Always use care when using zippers to avoid injury to the child. Failure to follow any warning may result in death or serious injury to the child. 7AM does not hold itself liable for any injury.