

7 A.M.[®]
ENFANT
P A R I S
N E W Y O R K

User Manual
K-PONCHO

User Manual

K-PONCHO

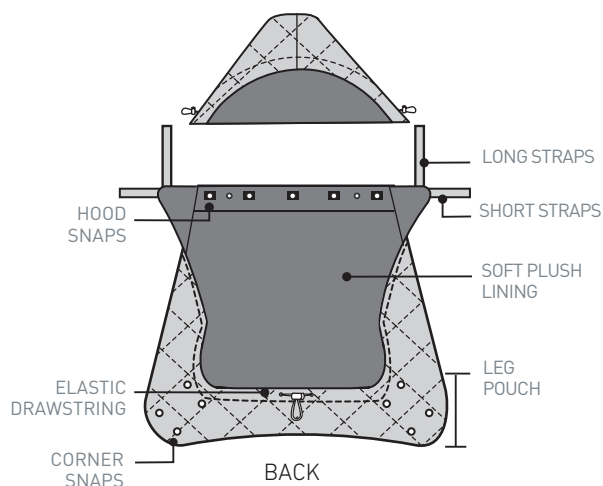
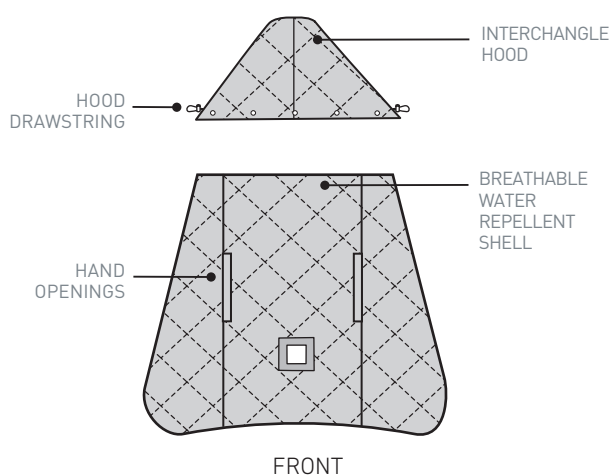

UP TO 9 MONTHS

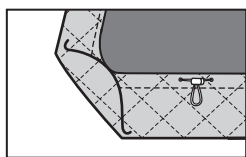

ON BABY CARRIER AND STROLLER

Fold and snap the bottom corners for a nestled fit and reduced bulkiness.

FROM 9 MONTHS & UP

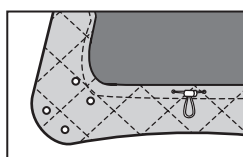

ON BABY CARRIER

Unsnap to unfold bottom corners for child's legs to wrap around your waist.

HOW TO USE ON CARRIER

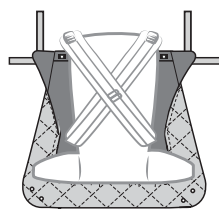

- 1 Lay the K-Poncho lining facing up onto a flat surface.
- 2 See "How to install hood." Use the elastic drawstring to tighten the contoured hood.
- 3 Place the carrier on top of the K-Poncho.

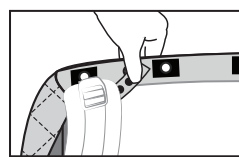

- 4 Secure the short right and left hook & loop strap to wrap under the top of the carrier's shoulder straps.

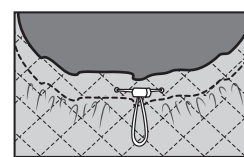

- 6 Place your baby in the carrier per the manufacturer's instructions.
- 7 Adjust the snugness using the elastic drawstring located behind the leg pouch.
- 8 Use the two hand openings on the K-Poncho to keep your hands warm and rested on your baby.

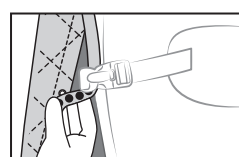

- 5 Secure the right and left long strap to wrap around the carrier's under arm side straps using the hook & loop.

INSTALLING THE HOOD

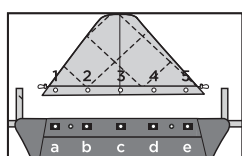

- 1 Put the K-Poncho's lining facing you.
- 2 Connect the snaps following either (A) installation facing outward or (B) installation facing inward steps.

INSTALLATION FACING OUTWARD

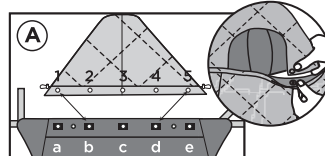

- 3 Place the hood above the top of the K-Poncho, lining facing opposite of the K-Poncho pouch.
- 4 Connect snap 1 to snap B and snap 5 to snap D.

INSTALLATION FACING INWARD

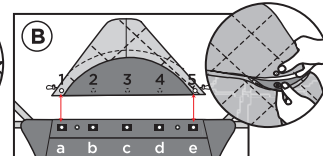

- 3 Place the hood above the top of the K-Poncho, lining facing towards you.
- 4 Connect all snaps 1 to A up to 5 to E.

HOW TO USE ON CAR SEAT OR STROLLER

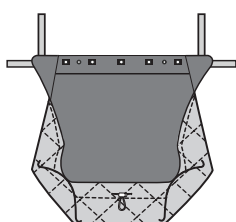
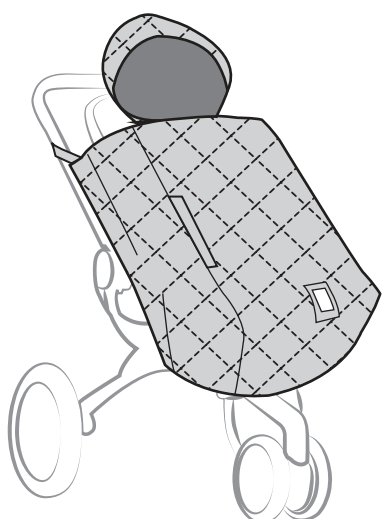

- 1 Fold and snap the bottom corners for a nestled fit and reduced bulkiness.
- 2 Seat your child in the car seat or stroller and fasten the safety harness as per their manufacturer's instructions.

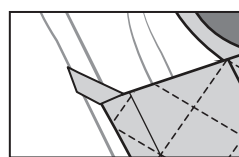

- 3 Secure the K-Poncho to the car seat or stroller by snapping the side straps around the stroller frame.

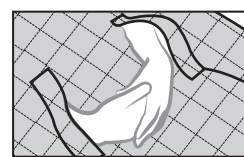

- 5 Adjust the snugness using the elastic drawstring located behind the leg pouch.
- 6 Your child can use the two hand openings on the K-Poncho to stick their hands out while strolling.



- 4 Attach hood facing outward (Follow "How to install hood").

The K-Poncho is machine washable. The care label is located on the back side of the product.

WARNING: Never leave child unattended in this product. Make sure that the child's face is not covered by any part of this product. Child should never be placed face-down in this product. Do not use this product as sleepwear or bedding. The child should not put buttons, plastic ends, snaps or other parts of this product into her/his mouth. Always use care when using zippers to avoid injury to the child. Failure to follow any warning may result in death or serious injury to the child. 7AM does not hold itself liable for any injury.