

7 A.M.[®]
ENFANT
P A R I S
N E W Y O R K

User Manual

BLANKET 212

EVOLUTION[®]

PLUSH COLLECTION

User Manual

BLANKET 212 EVOLUTION® PLUSH COLLECTION

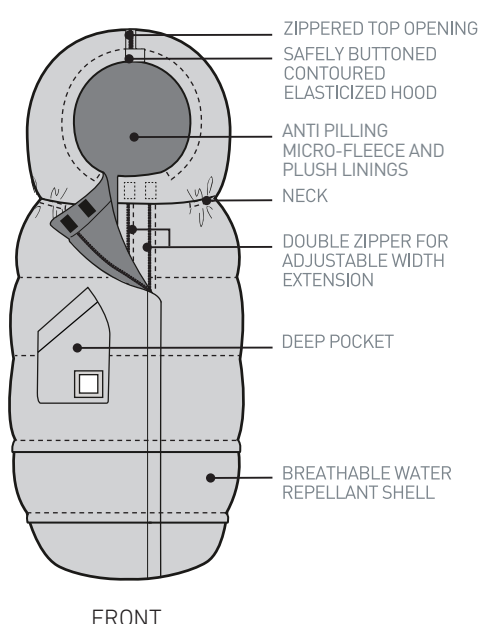

FRONT

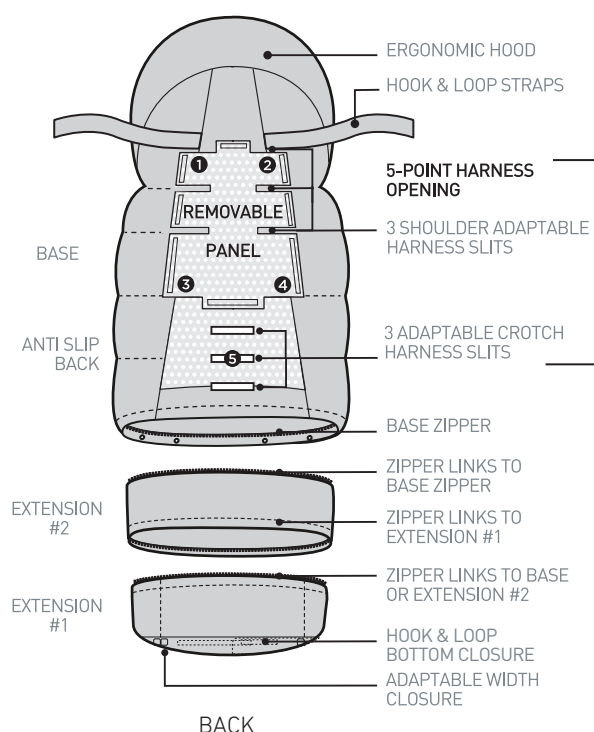

BACK

HOW TO USE ON STROLLER

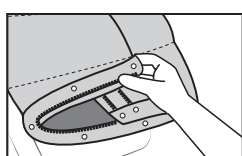
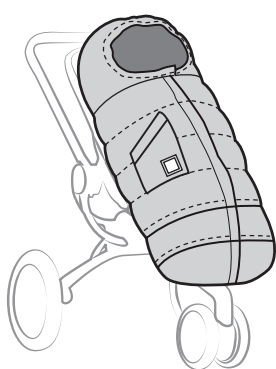

- 1 Adjust the B212e to your child's size by removing the zippered extensions (see "How to adjust length").
- 2 Place the B212e onto the stroller.

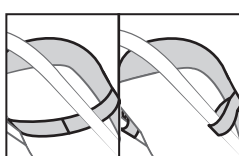

- 3 Use the hook & loop straps located on the sides of the B212e to attach to the stroller's back or sidebars to secure it.
- 4 Unzip to open the B212e.

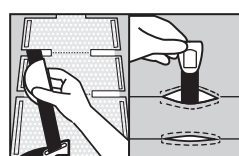

- 5 Pull the stroller's 5-point harness through the opening slits located on the back of the B212e by choosing the height of the slits corresponding to your child's size.



- 6 Seat your child on the B212e in the stroller and fasten the safety harness as per manufacturer's instructions.
- 7 Zip the front of the B212e up.
- 8 Put the hood on or off your child's head and adapt closure as desired by pulling the safety buttoned, contoured, elasticized hood.

HOW TO USE ON CARSEAT

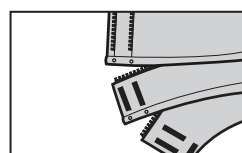
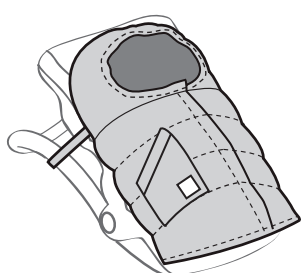

- 1 Adjust the B212e to your child's size by removing the zippered extensions (see "How to adjust length").

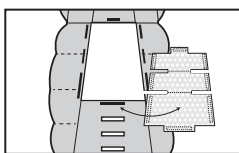

- 2 Detach the removable back panel to reveal the large back opening and to eliminate material between your baby's back and the car seat. Store it for stroller use.
- 3 Place the B212e onto the carseat and unzip to open the B212e.



- 4 Pull the carseat 5-point harness through the large back opening.
- 5 Seat your child on the B212e in the carseat and fasten the safety harness as per manufacturer's instructions.

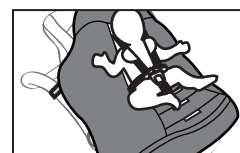

- 6 Whether the carseat is used in the car or on a stroller, you can leave the B212e open or closed as desired.

HOW TO USE IN BASSINET

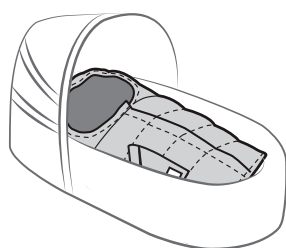

- 1 Remove the zippered extensions (see "How to adjust length").
 - 2 Open the B212e and place into the bassinet.
 - 3 Lay your baby on the B212e. Make sure your baby's face is uncovered at all times.
 - 4 Zip the B212e up using the most narrow zipper position to cover your baby.
- ⚠ Do not use the B212e as bedding in a crib or at home bassinet.

HOW TO ADJUST LENGTH

The two extensions are already attached to the B212e when purchased.

Size 0-6M: No extension

- 1 Unzip extensions.
- 2 Snap bottom end of base closed.

Size 6-18M: Base + 1 extension

- 1 Zip up extension #1 to base.
- 2 Close bottom of extension #1.

Size 18-4T: Base + 2 extensions - Full size

- 1 Zip up extension #2 to base.
- 2 Zip up extension #1 to extension #2.
- 3 Close bottom of extension #1.

Take note: Set extensions aside for when your child has outgrown the first and second size. We do not sell replacements.

HOW TO ADJUST WIDTH

According to your child's age, weight and desired comfort:

- 1 Base: Zip up to one of the double zippers to reduce or expand the blanket in width.
- 2 Close bottom of extension #1.

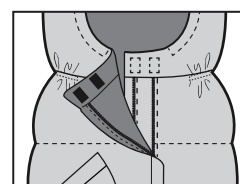

After the winter season, you may machine wash the B212e and store it in its packaging until the winter days are upon us again. The care label is located on the back side of the product.