

MAGNUSON

SUPERCHARGERS

Installation Instructions for:
2007+ Toyota Tundra 5.7L
-Not for Flex Fuel Trucks-



Step-by-step instructions for installation of
the supercharger system.

*** PREMIUM GASOLINE FUEL REQUIRED ***



ATTENTION!
Your MAGNUSON SUPERCHARGER kit
is sensitive to corrosion!
Use only the vehicle manufacturer
recommended coolant for your engine in
the intercooler system as well.

Magnuson Products LLC
1990 Knoll Drive, Bldg A, Ventura, CA 93003
(805) 642-8833 phone
magnusonsuperchargers.com

INSTALLATION MANUAL

Magnuson Supercharger Kit: Toyota Tundra 5.7L

Please take a few moments to review this manual thoroughly before you begin work: Make a quick parts check to be certain your kit is complete (see Bill of Material (BOM) parts list inside the accessory box). If you discover shipping damage or shortage, please call our office immediately. Take a look at exactly what you are going to need in terms of tools, time, and experience. Review our limited warranty with care.

Use only premium gasoline fuel, 91 octane or better.

Magnuson Products recommend that you run a minimum of one (1) tank of premium fuel through your vehicle prior to installation of the system to prevent any possible damage that may occur due to running the supercharged engine on lower octane fuel.

Magnuson Products Supercharger systems are designed for engines and vehicles in "GOOD" mechanical condition. Magnuson Products recommend that a basic engine system "Health Check" be performed prior to the installation of this supercharger system. Be sure to check for any pending or actual OBDII codes and fix/repair any of the stock systems/components causing these codes. If there are codes prior to the installation they will be there after the installation.

Magnuson Products also recommend the following services to be performed on your vehicle before starting and running the vehicle post supercharger system installation:

- Fuel Filter change
- Engine oil and filter change using brand name oil (organic or synthetic) and filter
Note: It is VERY IMPORTANT to use the factory specified oil viscosity. The original equipment manufacturer has selected this grade of oil to work with your other engine systems such as hydraulic chain tensioner and variable cam controls. Deviation from this specification may cause these systems to fail or not function properly. Please refer to your owner's manual for the recommended oil viscosity for your engine and application.

- On newer vehicles not requiring new spark plugs it is important to verify the spark plug air gap.

On older vehicles Magnuson Products recommend these additional services to be performed:

- New spark plugs with the air gap set at the factory specifications OR new specifications if required by the installation manual.
- Coolant system pressure test and flush. **NOTE: YOU MUST USE TOYOTA SPECIFIED COOLANT MIXTURE!**

Non "Magnuson Approved" calibrations or "tuning" will Void ALL warranties and CARB certification.

Our supplied calibration is designed for use with the components provided in this kit. Any adjustment to the intake, or exhaust systems or other engine components may adversely affect engine performance and may trigger your check engine light.

Drive belt = Dayco 5081125

Tools Required

- Metric wrench set**
- Metric 3/8" and 1/2" drive metric socket set (standard & deep)**
- 3/8" and 1/2" drive ft-lbs and in-lbs torque wrenches**
- Metric Allen socket set 3/8 drive**
- Metric Allen wrenches**
- Phillips and flat head screwdrivers**
- Serpentine belt tool**
- Funnel**
- Drain pan**
- Hose cutters**
- Hose clamp pliers**
- Safety glasses**
- Nut driver**
- Compressed air**
- Air gun**
- Heat gun**
- Torx socket set 3/8 drive**
- Fuel tank lock-ring tool**
- Anti-seize assembly lube (for spark plugs)**

Contact Information:

Magnuson Superchargers
1990 Knoll Drive, Bldg A
Ventura, CA 93003

Sales/Technical Support Line (805) 642-8833
Websites www.magnusonsuperchargers.com
Email sales@magnusonsuperchargers.com

Table of Contents

Section 1: Initial Preparation	5
Section 2: Coolant Drainage	6
Section 3: Intake Manifold Removal	8
Section 4: Water Bypass Pipe, and Joint Replacement	14
Section 5: Fuel Injector Replacement	26
Section 6: Air Box and Spark Plug Replacement	31
Section 7: Supercharger Preparation and Installation	34
Section 8: Serpentine Belt, Throttle Body and Hose Installation	37
Section 9: Intercooler System Installation	47
Section 10: Intercooler Pump Wiring Connections	63
Section 11: Fuel Pump Replacement	67
Section 12: Coolant Fill, and Final Testing	76

NOTE: This instruction manual follows the process we used to complete this installation on our test vehicle. This does not imply there aren't alternate approaches. If you find a procedure or process that improves the installation, please let us know! We strive to create the most comprehensive and complete instruction manuals available.

Section 1: Initial Preparation

1. **If your kit has a provided handheld tuner follow the instructions in the provided pamphlet to install your tune. Your handheld tuner may not match the one shown.**



2. Your Intercooler system is sensitive to corrosion. It's very important to use the OEM recommended coolant mixture in your supercharger system as well.



3. Your system requires the use of a minimum 91 Octane gasoline fuel. This system is **not** compatible with E85 fuel.



Any reference to the left or right side of the vehicle is given from the driver's seat perspective.

4. Remove the cables from the battery with a 10mm wrench. The battery is located in the left front area of the engine compartment. Remove the battery hold down using a 10 mm socket wrench to loosen the two nuts shown with arrows. Then rotate the studs to disengage the lower hooks. Pull the battery out of the vehicle. This will allow clearance for the installation of new kit items. Now would be a good time to clean the plastic battery tray and metal underneath.

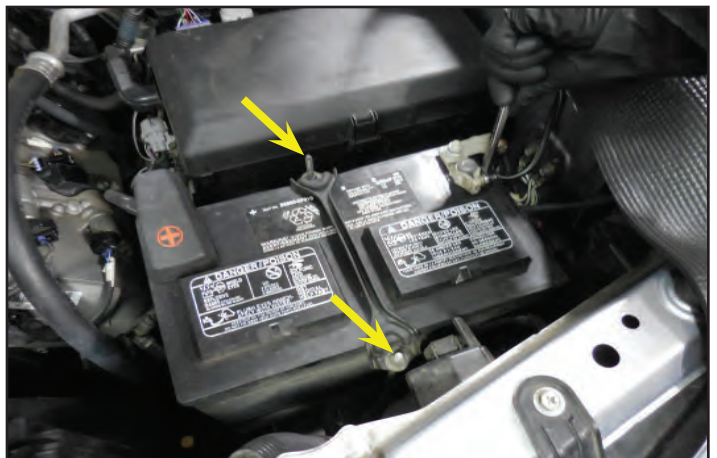

5. Remove the engine cover. Lift up at the front of the cover, and then pull away from the fire wall.



6. Relieve the fuel pressure by removing the fuel cap. Replace the fuel cap after pressure has been relieved. Wipe down the surface behind the fuel cap with denatured alcohol. Apply the provided "Use Premium Fuel Only" sticker to the area shown.



Section 2: Coolant Drainage

Allow the engine to cool down before draining any fluids.

7. Remove the skid plate. Use a 12 mm socket to remove the 5 bolts shown with red arrows (3 in back, and 2 up front). Use a 10 mm socket to remove an additional 3 bolts shown with yellow arrows.

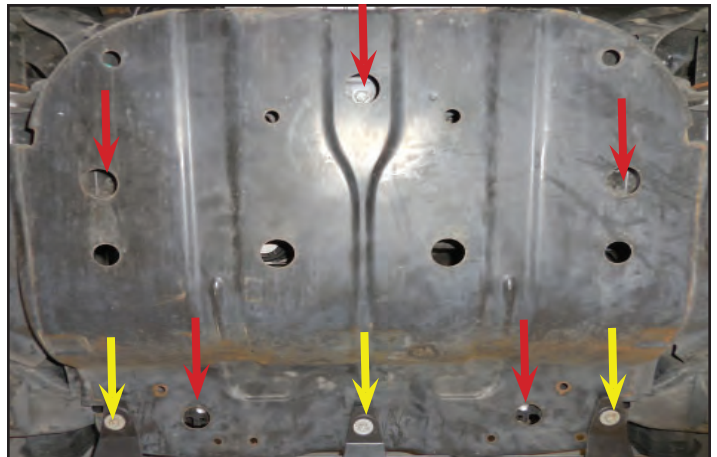

8. View of skid plate being removed.



9. Drain the coolant by opening the drain plug at the location shown with the arrow (lower left corner of the radiator). Have a clean pan, or bucket, ready for catching the fluid so that it may be reused.



10. Let the system drain completely before removing any hoses. This will take approximately 15 minutes to drain completely. Complete the next step to speed up this process.



11. Remove the radiator cap to help the coolant drain faster. Once the coolant has fully drained replace the cap, and tighten the drain plug.



12. Remove the clamps for the upper radiator hose where indicated with yellow arrows. Mark the end of the hose with a pen at the blue arrow area to indicate that this is the radiator side. This hose will be flipped when it is reinstalled later.

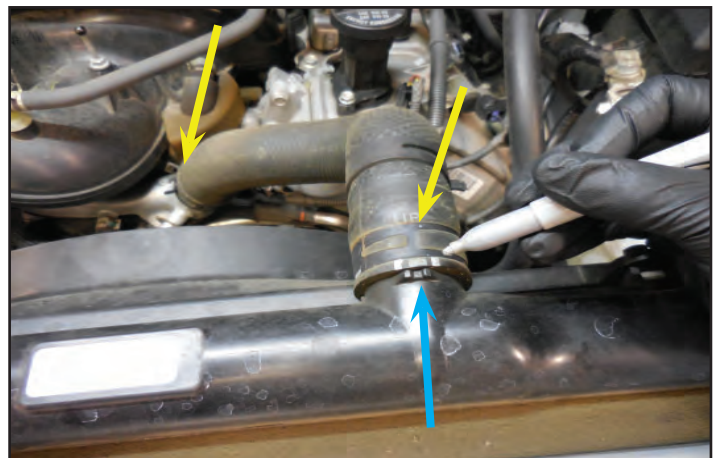

13. Place some rags under the hose connection at the cross over to prevent coolant from getting on the belt/pulleys. Remove the upper radiator hose.



14. Plug both coolant hose connections with clean towels to prevent anything from falling into them.



Section 3: Intake Manifold Removal

15. Use an 10 mm socket or nut driver to loosen the two hose clamps holding the air inlet tube in place.



16. Disconnect the vacuum and ventilation hoses at the locations shown. Slide the clamps back where necessary.



17. Remove the inlet hose assembly.



18. Disconnect the ventilation hose from the left side valve cover shown with the yellow arrow. Slide clamp upward. Then pull up on the hose.



19. Disconnect the other ventilation hose that is connected at the right valve cover shown with the arrow.



20. Remove the two mounting bolts at the locations shown with arrows.



21. Remove the hose assembly you just disconnected from the engine. Re-install the screws removed from the previous step back into their respective locations.



22. Disconnect the VSV hose shown with the arrow. This is located on the left side of the intake manifold. Slide the clamp back prior to pulling on the hose.



23. Disconnect the brake booster hose shown with the arrow. This is located at the left rear of the engine. Use pliers to slide the clamp back prior to pulling on the hose.

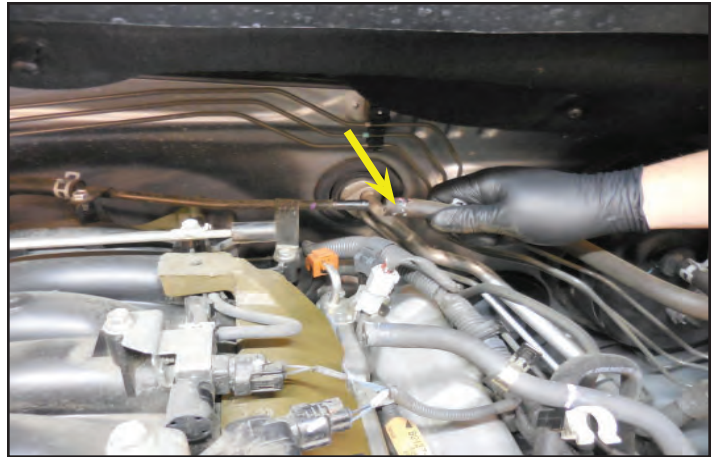

24. Disconnect the two VSV and ACIS electrical connections shown.



25. Remove the foam engine cover from the left side of the engine. Discard this part.



26. Remove the foam engine cover from the right side of the engine. Discard this part.



27. Disconnect the ventilation hose shown. Squeeze the clamp and pull back on the hose simultaneously.



28. Disconnect the electrical connection for the throttle body.



29. Disconnect the coolant line at the location shown. Use pliers to slide the clamp back.



30. Disconnect the second coolant hose shown with the arrow.

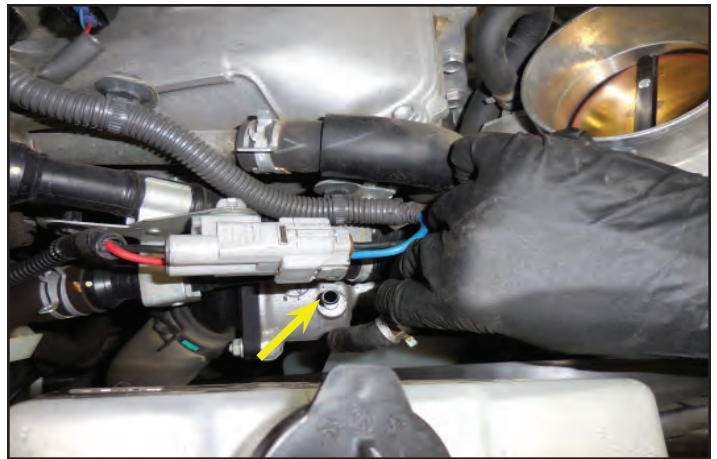

31. Use a 10 mm socket to remove the 4 bolts holding the throttle body in place. Save these bolts.

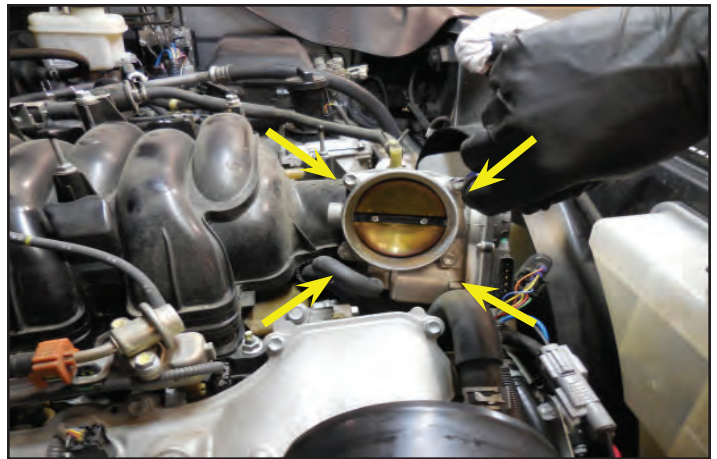

32. Remove the throttle body and hoses from the engine. Save these for use on the super-charger.



33. Note: This step applies only to 2014+ Tundra. Ignore this step if you have a 2007-13.

Remove and discard the bracket shown by first removing the nut shown with a yellow arrow using 10 mm socket wrench. Then remove the bolt shown with the red arrow. This is located on the right rear corner of the intake manifold.



34. At the right rear corner of the intake manifold use a pick to disengage the wire harness clip shown.



35. Use a 12 mm swivel socket to remove the 2 nuts and 8 bolts holding the manifold in place. Save these for use later.



36. At the back of the manifold there are two clips which hold a wiring harness. Remove the wiring harness from the clips prior to pulling the manifold out. Remove the manifold, and set aside. Some parts from the manifold will be reused. Be careful not to damage the gaskets on the underside of the manifold when removing from the engine.



37. Now use a shop towel with denatured alcohol, or some other non-petroleum based solvent to clean around the intake openings. Vacuum out any debris from around the intake ports.



38. Place tape over the ports to prevent anything from falling into them.

It is VERY important to not contaminate your work environment or allow any debris to fall into the exposed ports, or engine damage can occur.



39. Use a breaker bar with a 14 mm socket and release the tensioner (located at the yellow arrow) to remove the OEM belt.



Section 4: Water Bypass Pipe, and Joint Replacement

Refer to the owners manual for proper lifting of vehicle, and wheel removal.

40. Raise the truck, and remove the left front wheel using a 22 mm socket.



41. With the front left wheel removed you will be able to remove the panel shown with the arrow for access to the A/C compressor.

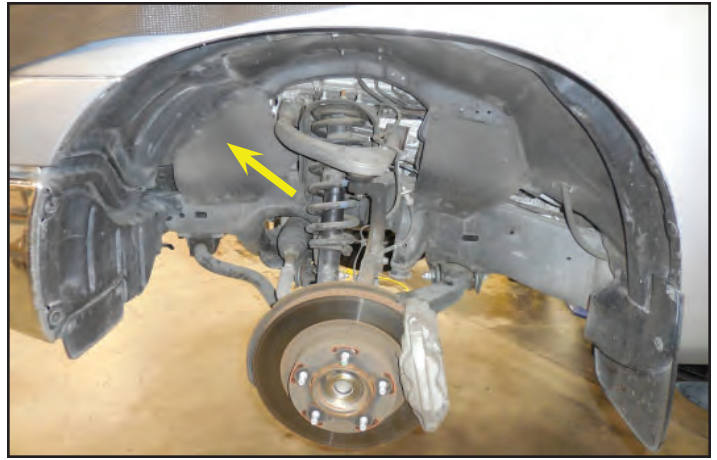

42. Remove the 6 button rivets shown, and remove the panel.

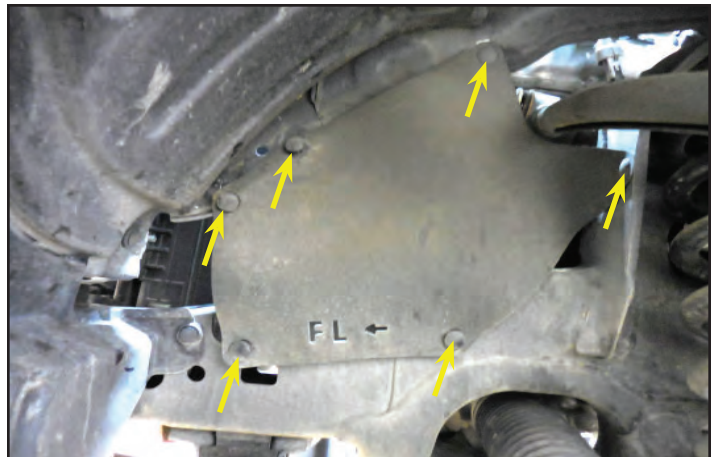

43. Remove the two nuts, and two bolts holding the A/C compressor to the engine. One of the nuts is obscured from view in this image. Slide the compressor away from the engine while keeping it on the 2 studs. You do not need to remove the compressor.

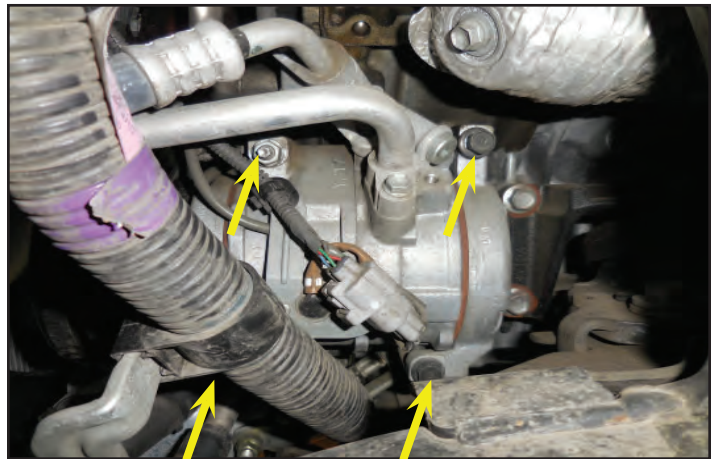

44. Remove the coolant hoses attached to the oil cooler shown with arrows in this image. Have a container ready to collect the coolant that will drain from these hoses. **Note: Picture is from the underside of the vehicle looking upward.**

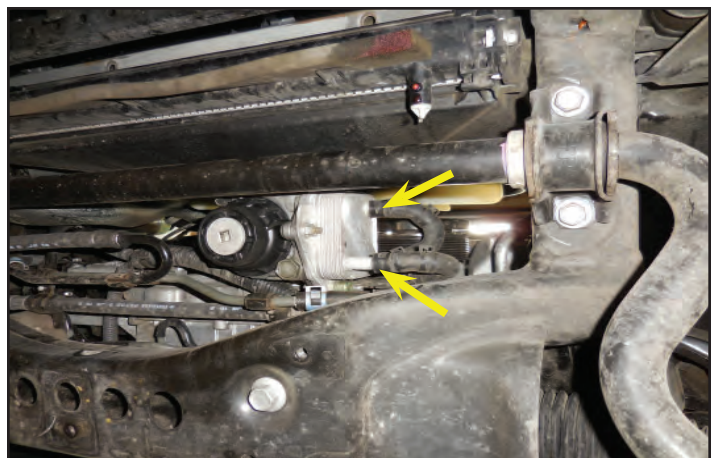

45. Here the coolant is being collected from the two coolant hoses disconnected in the last step. Pull down/straighten out the hoses to get all the coolant out.



46. Remove the hose shown after disconnecting the two clamps.



47. Disconnect the hose shown with the arrow.

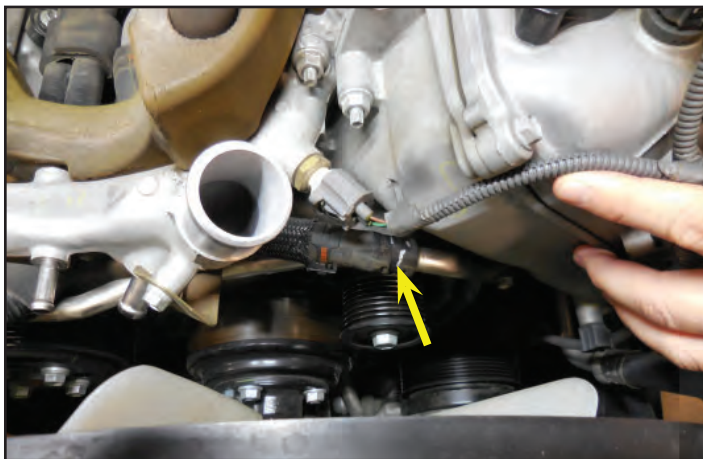

48. Remove the bolt at the front of the coolant cross-over using a 10 mm socket. This will not be reused.



49. Remove two more bolts (shown with arrows) holding the bypass pipe assembly.

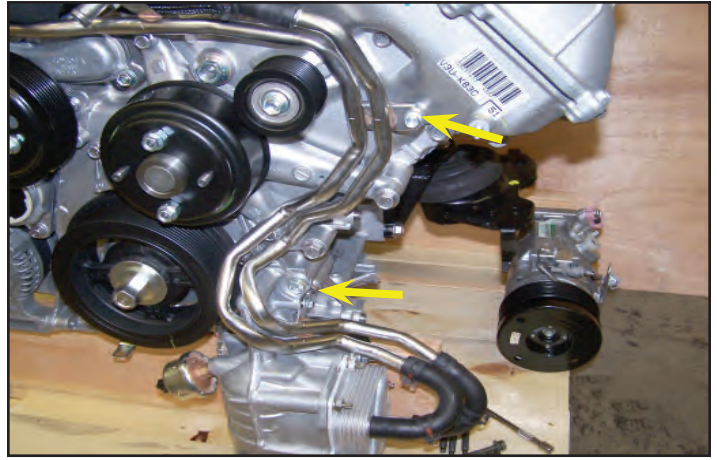

50. Remove the bypass pipe assembly shown. You may need to slide the A/C compressor further away to gain room to remove the tubes. Also make sure the hoses at the bottom of the tubes aren't getting caught on anything.



51. Here is a better view of the oil cooler hard-lines. Only the hoses and clamps will be reused in a later step.



52. Discard the front foam engine cover.



53. Disconnect the coolant hose from the hard-line where shown.



54. Unplug the water temperature sensor.



55. **Note: This step applies only to 2014+ Tundra. Ignore this step if you have a 2007-13.** Disconnect the two heater hoses where shown with yellow arrows. Rotate the clamps at the PCV valve (shown with red arrows) to the side to make more clearance for the supercharger.

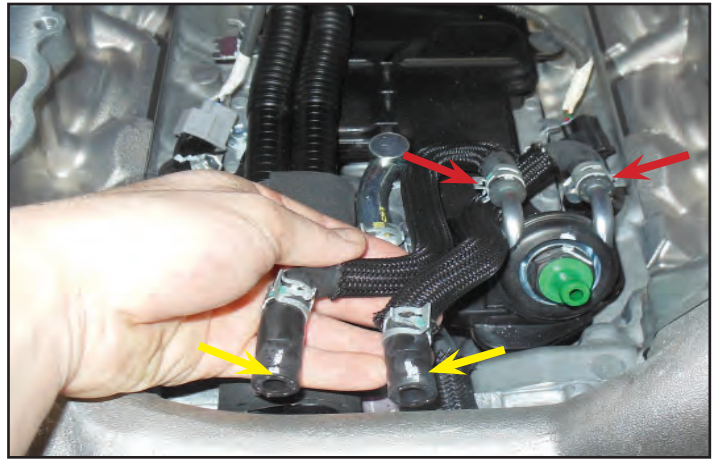

56. Remove the four nuts holding the coolant cross-over in place. Two are obscured from view in this image. The nuts and gaskets will be re-used. Set the coolant cross-over aside.



57. Remove the ventilation hose shown. This will be replaced in a later step.



58. Clean the mounting surfaces of the coolant cross-over with a clean rag. Ensure that the surface is clear of any debris, or old gasket material.



59. Inspect the OEM gaskets from the coolant cross-over, and install them in their original locations. Replace them if they are damaged. **Ensure that you have installed both gaskets.**



60. Remove the hose line shown with the arrow. This will be reinstated later.



61. Apply a thin bead of coolant safe RTV to the surface of the supplied coolant cross-over.

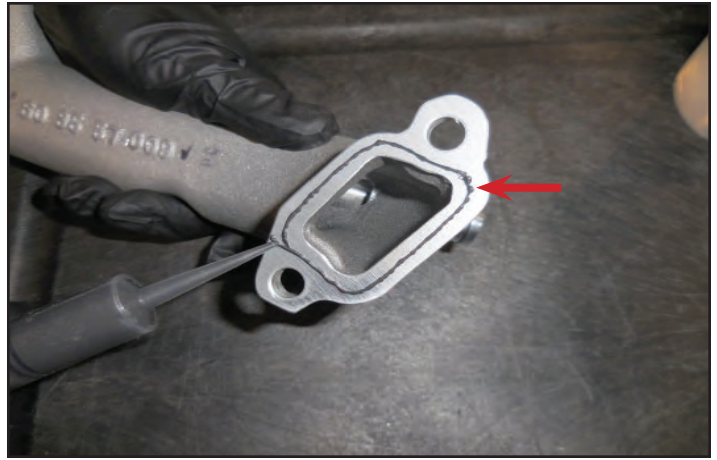

62. Install the supplied coolant cross-over, and secure it with the OEM nuts. **Torque the nuts to 15 ft-lb. Ensure that the OEM gaskets are being reused to seal the coolant cross-over.**



63. Remove the section of hose from the OEM coolant cross-over. This will be reused.



64. Reinstall the OEM hose on the supplied coolant cross-over from the last step using the OEM clamps.



65. Remove the temperature sensor from the OEM coolant cross-over using a 3/4" wrench.



66. Ensure that the copper washer is in place before installing on the supplied coolant cross-over.



67. Install the OEM temperature sensor in the location shown with a 3/4" wrench. **Torque to 14 ft-lb.**



68. Use a 12 mm socket to remove the bolt shown with the blue arrow. Use a 14 mm socket to remove the two bolts shown with yellow arrows on the timing chain cover. Discard these three bolts.

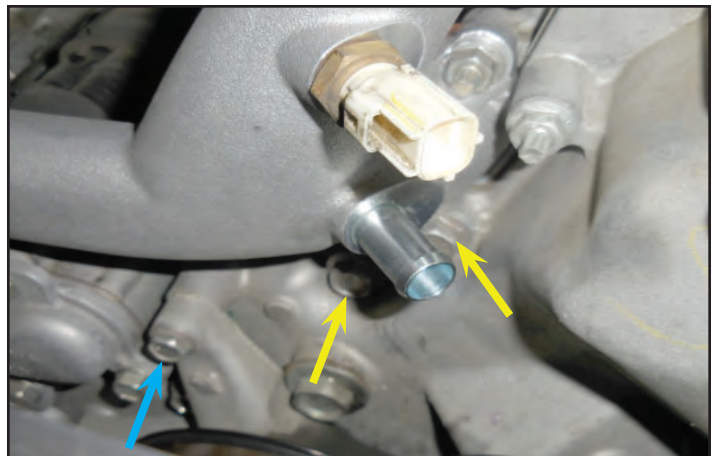

69. Install the provided bracket and bolts shown to the vacant holes from the last step.



70. **Torque the 6mm socket head bolt to 18 ft-lb, Torque the two 14 mm hex head bolts to 35 ft-lb.**



71. Reinstall the coolant hose (highlighted in red) at the location shown with the arrow. Route the hose through the idler pulley bracket as shown. Ensure that the clamp is rotated to the side to give clearance for the supercharger.



72. Remove the hose clamps, and hoses shown from the OEM throttle body. These will be reused, but in a different configuration.



73. **Note: This step applies only to 2014+ Tundra. Ignore this step if you have a 2007-13.** Use the hose with the meshed covering from the throttle body just removed in the last step. This will get attached where shown with an arrow and cut as shown in the photo.



74. **Note: This step applies only to 2014+ Tundra. Ignore this step if you have a 2007-13.** Use a 5/16" hose mender and two clamps to connect the hose from last step to the right side hose going to the heated PCV valve (shown with an arrow).



75. **Note: This step applies only to 2014+ Tundra. Ignore this step if you have a 2007-13.** Connect the provided 14" long 5/16" diameter heater hose to the other PCV valve hose (shown with an arrow) using a 5/16" hose mender and two clamps. Cover 14" hose with 14" long meshed sleeve. The opposite end of the 14" hose will be connected to the throttle body in a later step.



76. Install the idler pulley to the idler bracket using the provided M10 x 30 mm length bolt. **Torque the idler pulley bolt to 35 ft-lb.**

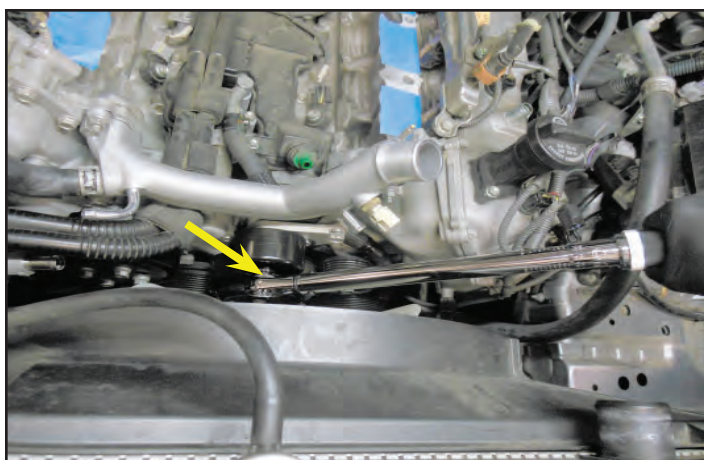

77. Unclip the wire harness from the stud shown. This is located at the front left side of the engine.

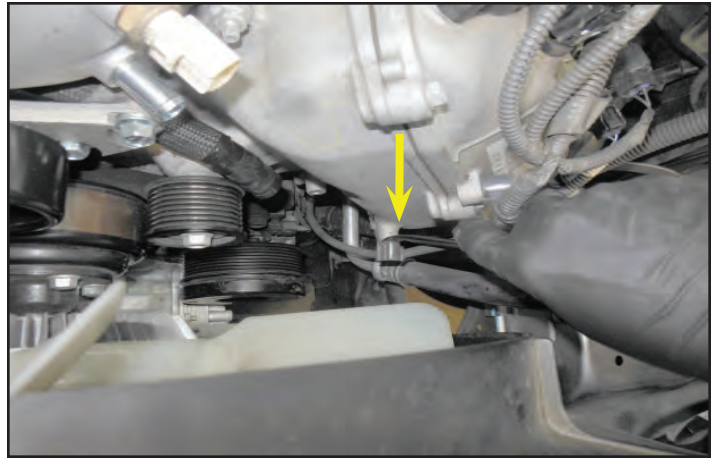

78. Use an E-6 (external torx) socket to remove the stud shown. This will be discarded.

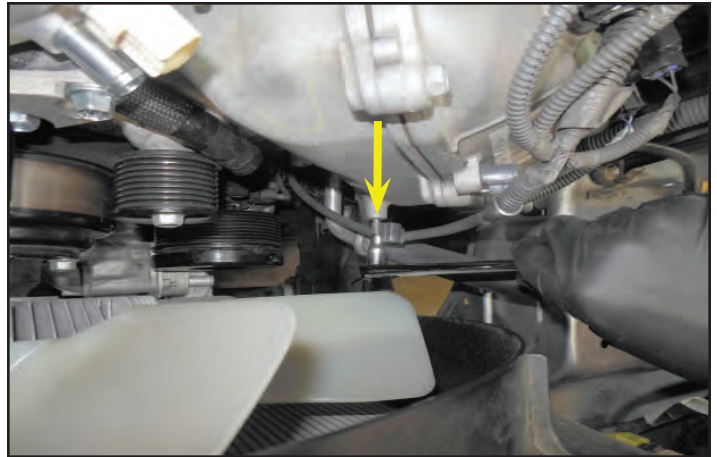

79. Install the provided M6 x 30 mm stud using a 3 mm Allen socket in the location where the stud from the last step was removed.

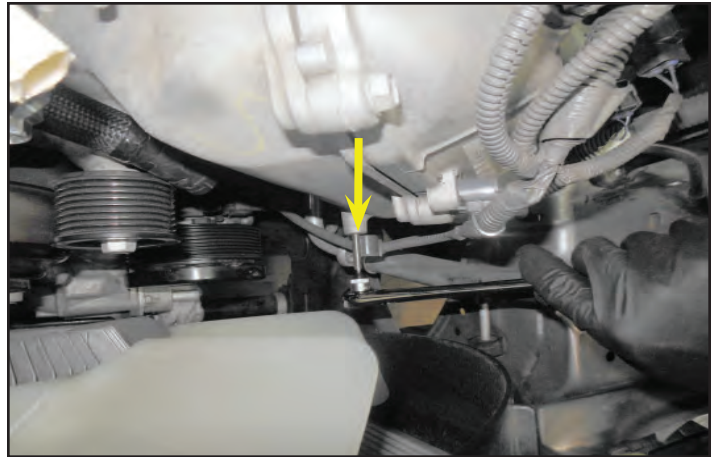

80. Connect provided oil cooler hard lines to the OEM hose locations (shown with arrows) using the OEM clamps. The tab on the hard lines should locate on the stud installed in the previous step.

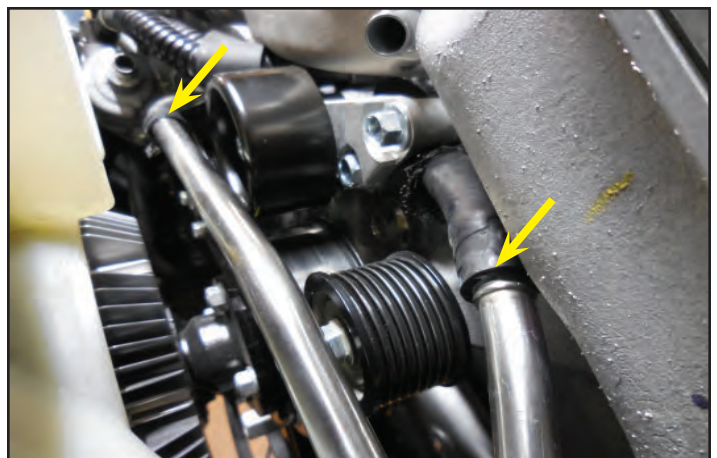

81. Connect the wiring harness for the temperature sensor.



82. Install the lower OEM hoses to the provided oil cooler hard coolant lines with the OEM clamps. The hoses connect the hardlines to the oil cooler. **Note: For reference this picture is looking upward from underneath the cooler.**



83. Ensure that the tab from the provided hard lines is attached at the stud location shown. Install the provided nut onto the stud where shown. **Torque to 106 in-lbs.**

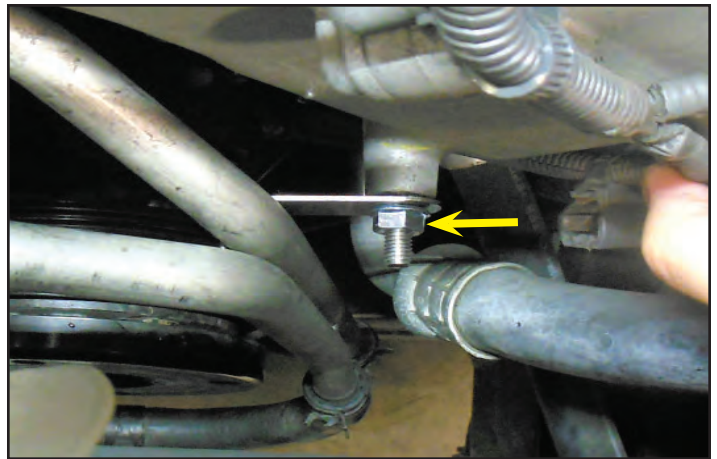

84. Reinstall the wire harness to the stud shown.

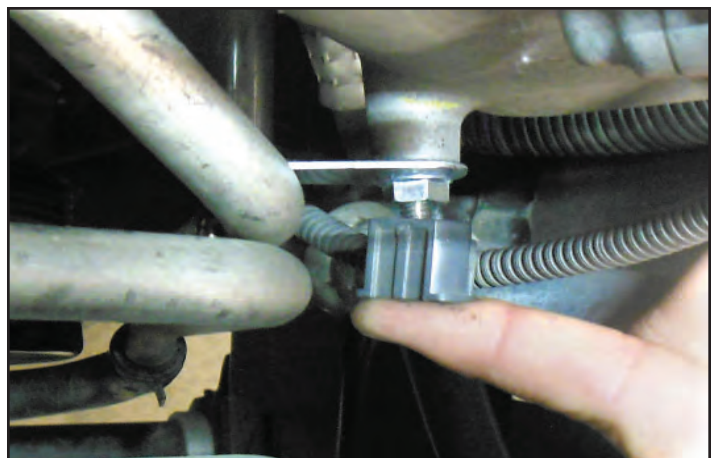

85. Reinstall the A/C compressor using the OEM nuts and bolts. **Torque all three locations to 18 ft-lbs.**



86. Reinstall the panel that covers the A/C compressor in the wheel well.



87. Reinstall and **torque the wheel to the specifications given in the owner's manual.**



Section 5: Fuel Injector Replacement

88. Disconnect the wiring harness from both fuel rails. This image shows the left side being disconnected.



89. Pull up on the rear fuel cross over line to disengage it from the retaining clips.

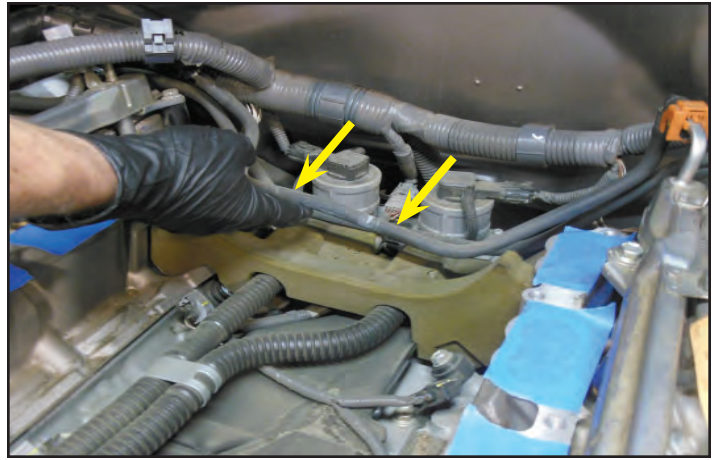

90. Wrap a towel around the fuel line connection shown. Disconnect the left side fuel line connection. Let the towel catch any fuel, then wrap the female fitting with a fresh towel. Slide back the orange safety clip then push in on the colored sides to allow the fitting to be removed.



91. Disconnect the right side fuel connection shown. Repeat the same process as in the previous step.



92. Use a 12 mm socket wrench to remove the four fuel rail mounts. **Note: The picture shows a front cross-over line installed. We temporarily installed this to contain the fuel. You can cap or plug the connections to achieve the same result.**

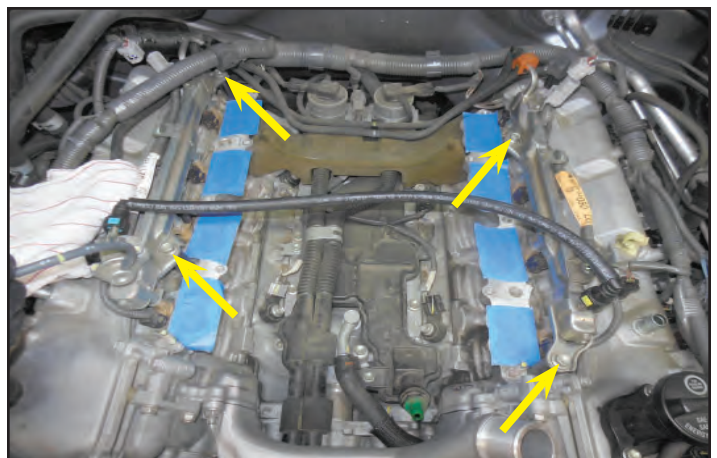

93. Remove the four fuel rail spacers.



94. Pull the fuel rails straight up with the injectors attached. **Important: Make sure the injectors stay installed in the fuel rails otherwise fuel will spill out. Take your time and slowly remove the assemblies.**



95. Use smooth needle nose pliers to carefully remove the eight seals from the fuel injector ports. These will be reused so take care when removing them. If you do not find the seal in the port it may be attached to the fuel injector. **Important: Be very careful to NOT knock any debris loose and down into the port. Take your time.**



96. Clean the seals with a bath of Simple Green or similar cleaning fluid. After they have soaked for a while wipe them off with a clean towel and inspect them for any damage. Replace any damaged seals.



97. Vacuum out the port locations to remove any loose debris. Also clean the ports with cotton swabs and Simple Green. Again, take your time, clean the ports thoroughly and make sure nothing falls down into them.



98. Tilt the fuel rail to one corner and place a plastic container under the corner. Remove the corner injector and let the fuel drain into the container. Repeat this process with another corner of the fuel rail to get more of the fuel out of the assembly. There is about 10 oz. of fuel in this assembly.



99. Take note as to the direction of each injector before you remove them and ensure the new injectors go in the same way. Remove each injector and unplug the electrical connector.



100. Clean the injector bores with a cotton swab and some Simple Green as shown.



101. Remove the new supplied injectors from the packages and examine the upper O-ring for any damage. Apply a small amount of the supplied lube to the O-ring.



102. Plug the electrical connector into the injector and insert the lubricated O-ring end of the injector into the fuel rail cup. Ensure that the tab from the injector fits between the two metal fingers as shown here with a yellow arrow. Also at this time apply a small amount of supplied lube to the base of each of the injectors where they contact the seals shown with the red arrow.



103. Reinstall the eight seals into the injector ports.

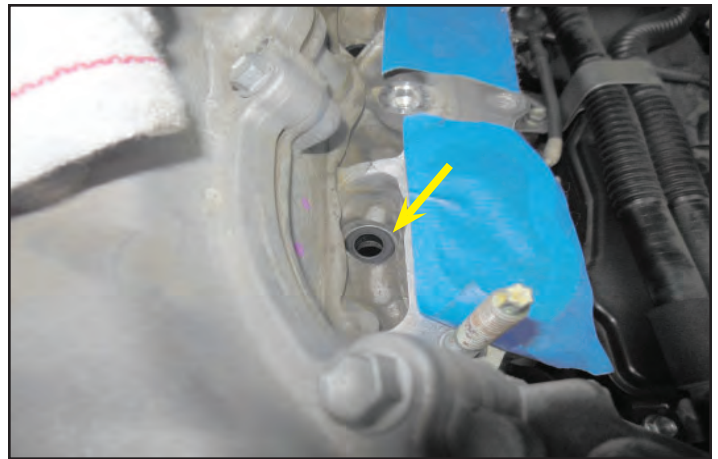

104. Install the new injector rail assembly into the eight seals installed in the last step. Loosely install the four fuel rail spacers and bolts. This will allow you some clearance when it comes to installing the supercharger. **Note: Install the bolts deep enough so that they prevent the spacers from lifting out of the grooves, but loose enough so that the rails can pivot side to side.**



105. Plug in the fuel injector harness on the left and right hand sides.



106. Reconnect the fuel delivery lines to the left and right side of the fuel rail. **Make sure the fitting "clicks" into place and can NOT be pulled upwards. Then engage the safety clip by sliding it back into place.**

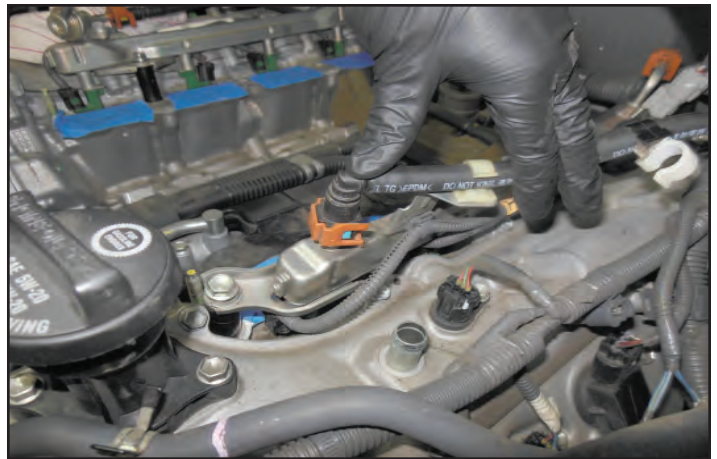

Section 6: Air Box and Spark Plug Replacement

107. Remove the air box lid by disengaging the four clamps (two shown with yellow arrows). Unplug the mass airflow sensor (shown with a red arrow).

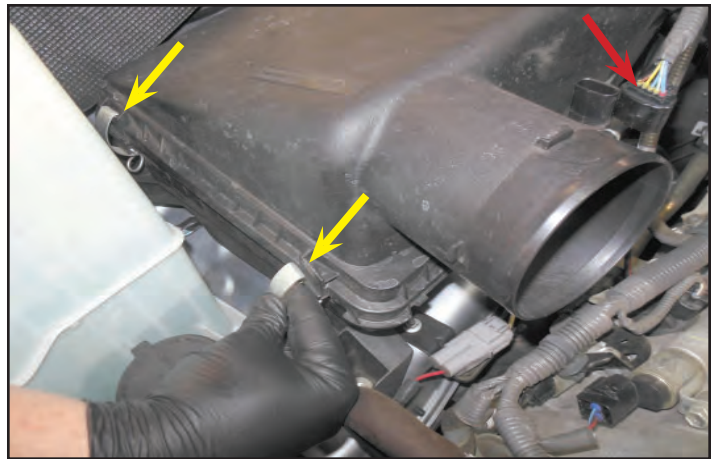

108. Detach the wire harness clip from the airbox lid using needle nose pliers, or a pick.



109. Remove the mass airflow (MAF) meter from the OEM air cleaner lid. **Discard the OEM air cleaner lid and the 2 OEM screws.** Install the MAF meter in the supplied air cleaner lid using the supplied #8x3/8" self tapping screws shown below.

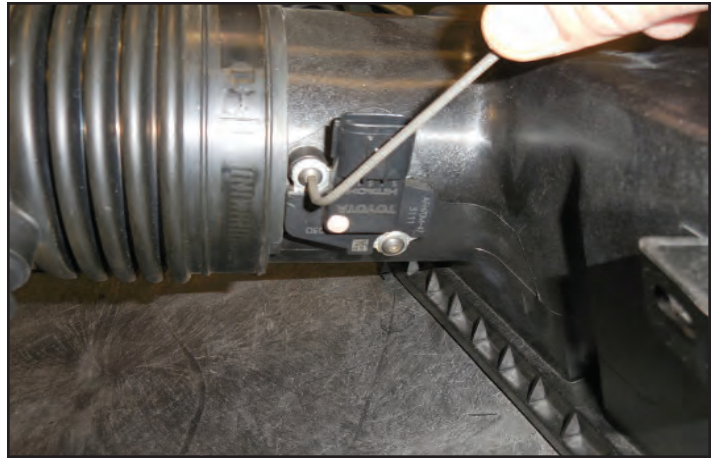

110. **Note: This step applies only to 2014+ Tundra. Ignore this step if you have a 2007-13.** Remove the air box bottom by removing the 2 bolts. Discard the two fasteners.

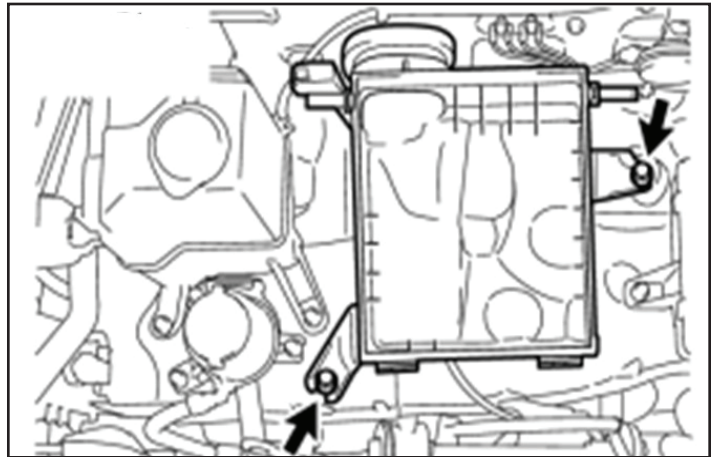

111. **Note: This step applies only to 2014+ Tundra. Ignore this step if you have a 2007-13.** Use a flat blade screwdriver to unclip the air inlet tube from the OEM air box bottom. The air inlet tube will be attached to the provided air box bottom. The OEM air box bottom will be discarded.

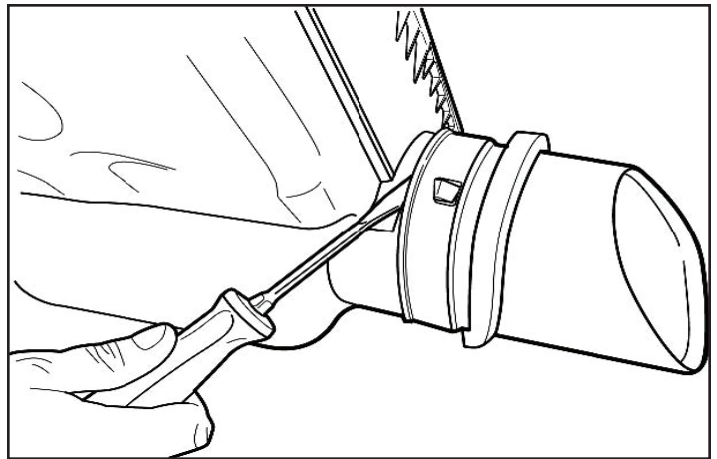

112. **Note: This step applies only to 2014+ Tundra. Ignore this step if you have a 2007-13.** Ensure that the notch lines up with tab and press the air inlet tube onto the provided air box bottom until clips engage. Remove the grommet from your old air box bottom and place it where shown with the red arrow.



113. **Note: This step applies only to 2014+ Tundra. Ignore this step if you have a 2007-13.** Install the new air box bottom using the bolts that are pre-installed. **Torque the bolts to 5.0 N-m (44 in-lb).**



114. Unplug all 8 coils, and remove the bolts with a 10 mm socket. The bolt has been removed from this coil pack from the location shown with an arrow.



115. Remove the coils by pulling them straight out. **Keep the coil packs in order so they are returned to their original location.**



116. Here is a coil pack with it's seal (shown with an arrow) attached. Clean these assemblies with a dry rag before reinstalling. Check the seals for damage and replace as necessary. **If the seal is not on the coil, then it should still be in the valve cover.**



117. Here are the 8 coil packs laid out in the order that they were located on the engine.



118. Use a 5/8" spark plug socket along with a universal joint and two extensions and a ratchet wrench to get to the rear plugs. The front plugs can be accessed with a long extension. Inspect the old plugs for any unusual signs. Plugs can reveal issues with the performance of an engine.



119. Place some anti-seize grease on the provided spark plug threads (Plug Gap: .032") Install the new spark plugs with the socket and extension, but without the ratchet wrench at first. This will allow you to feel the threads engage properly. Thread the spark plugs several full turns before using a ratchet wrench. **Torque the plugs to 13 ft-lb.**



Reinstall the 8 coil packs in their original locations. **Torque the bolts securing the coil packs to 80 in-lb.**

Section 7: Supercharger Preparation and Installation

120. Remove the left and right OEM intake gaskets from the manifold. Clean and inspect the gaskets. Replace if damaged. Apply a light coat of clean motor oil to the gaskets..



121. Place the OEM gaskets into the supercharger runner grooves as shown.



122. Remove the two nuts holding the harness clamps at the rear of the manifold. Install these clamps onto the back of the supercharger in similar location. These will be used to secure the wiring harness.



123. **Note: This step applies only to 2007-13 Tundra. Ignore this step if you have a 2014+.** Remove 1/2" of foam from the provided vent hose. **Be careful not to cut into the hose when removing the foam.**

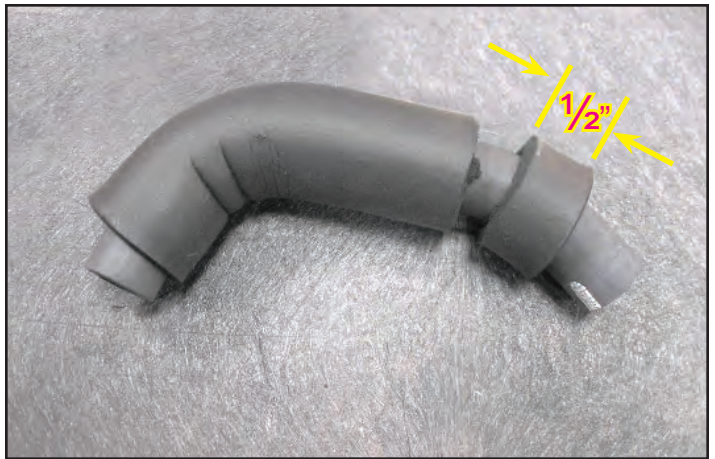

124. **Note: This step applies only to 2007-13 Tundra. Ignore this step if you have a 2014+.** Remove 1/2" from the end of the hose on the same side you removed the foam from the last step.

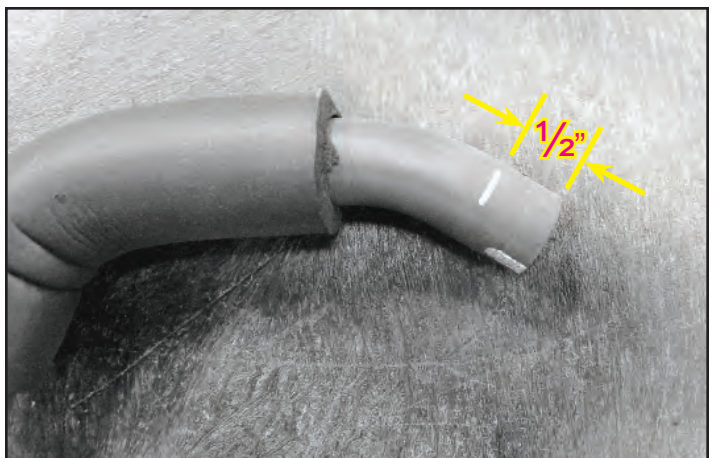

125. Attach the OEM spring clamp to the end of the provided PCV hose, and install at the location shown with an arrow.

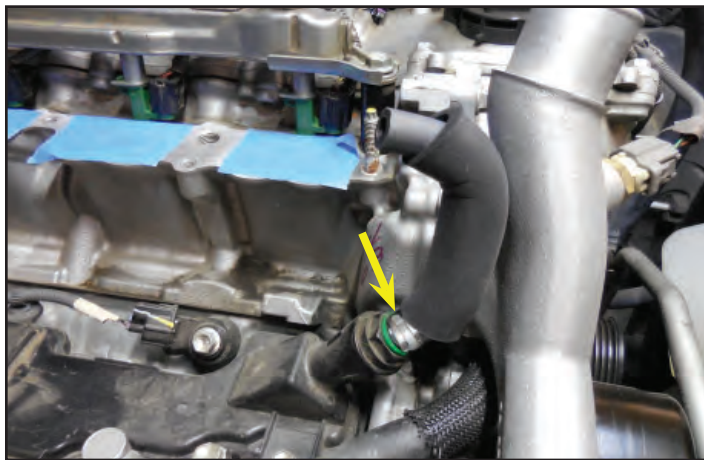

126. **Discard the rear foam engine cover (shown with an arrow).** Make sure everything is clear of the engine valley. Remove the tape covering the intake ports.

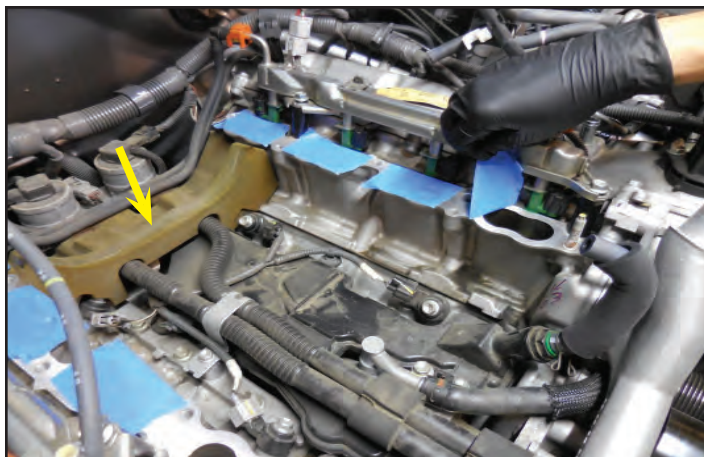

127. Spray Tri-Flow (or equivalent PTFE based lubricant) on a clean towel. Wipe the intake surfaces with Tri-flow on a clean towel.



128. With the help of a few friends, place the supercharger assembly onto the engine. **Be careful not to damage the gaskets on the underside of the supercharger.**



129. Install the OE bolts and nuts to secure the supercharger in place. Use a telescoping magnet (shown with a yellow arrow) to drop the bolts in place. **Note: The boost port location is shown in this photo with a red arrow. It has a rubber cap over it.**

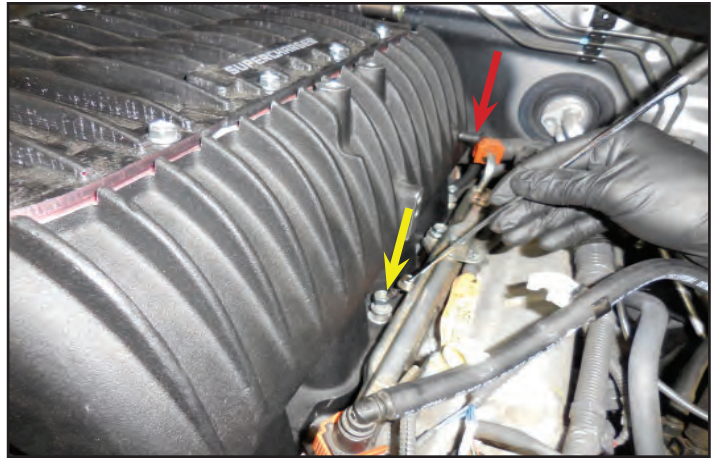

130. **Follow the torque sequence given in the diagram at the back of this manual. Torque the manifold bolts to 15 ft-lbs. Also at this time torque the 4 fuel rail bolts to 15 ft-lbs.**



Section 8: Serpentine Belt, Throttle Body and Hose Installation

131. Install the supplied belt according to the belt diagram at the back of this manual.



132. Cut the supplied $\frac{1}{2}$ " coolant hose to 3" and $2\frac{3}{4}$ " lengths and install on the supplied "J" shaped hard line with the provided hose clamps.

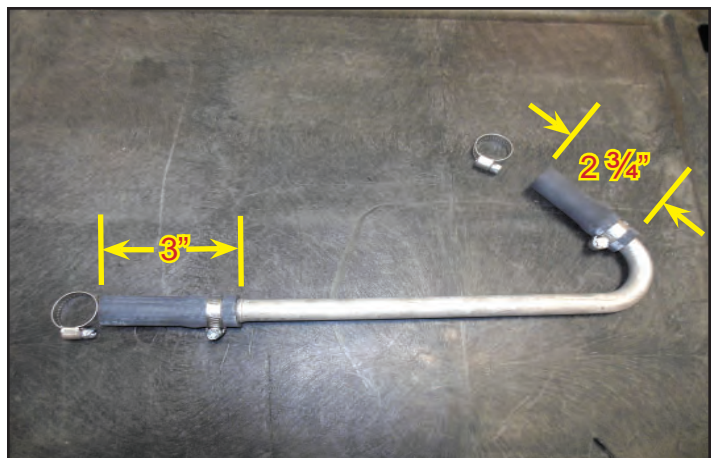

133. Install the “J” shaped hard line from the last step in the location shown with the provided hose clamps. Make sure the hardline has proper clearance to surrounding components. This line is easier to install to the straight side first.

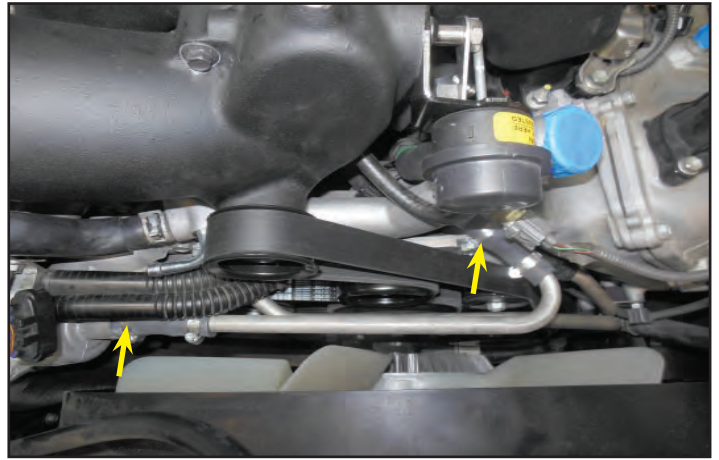

134. Clean the surface of your throttle body. This would also be a good time to clean the throttle plate with the appropriate throttle body cleaning fluid. Verify that the O-ring seal is installed in the inlet of the supercharger. Remove the red plug if equipped.



135. Install the 4 OEM bolts to secure the throttle body to the supercharger. **Torque to 106 in-lbs.**



136. Disconnect the front air injection connection (shown with a yellow arrow) and unclip the three harness clips (shown with red arrows). Open the wire harness and remove the wire loom wrap up to the junction where the wire loom that contains the throttle and air injection wires branch out from the main harness.

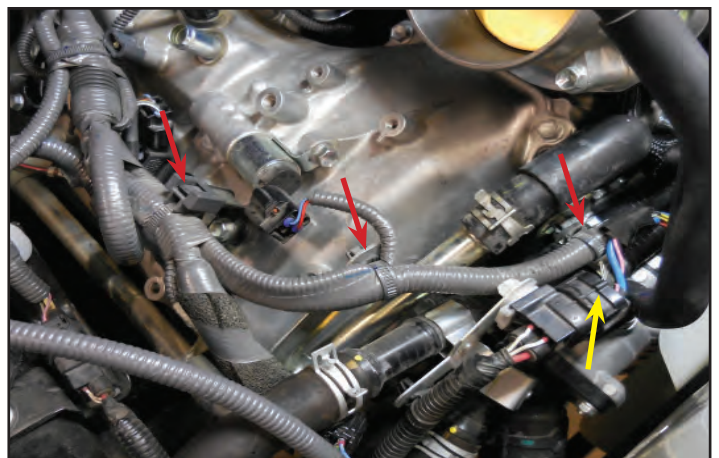

137. Separate the motor wires from the air injection wires. Install a 9" length of supplied 3/8" convoluted tube over the exposed throttle motor wires (shown with a yellow arrow) and secure it with electrical tape. Reinstall the original loom wrap over the air injection wires and secure it with electrical tape (shown with a red arrow). Tape the rest of the harness closed. Attach the 3 clamps back onto the harness and clip them to their mounting brackets.

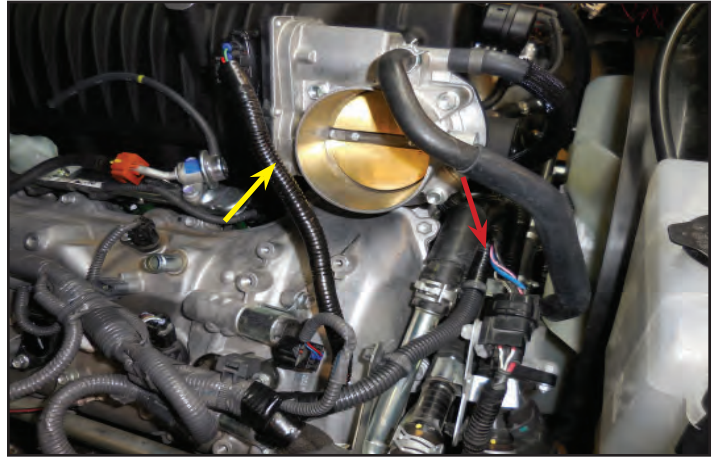

138. Install the right tube connection to the throttle body, and the other end to the thermostat housing. Slide the clamps over the connections.



139. **Note: This step applies only to 2007-13 Tundra. Ignore this step if you have a 2014+.** Here are the two OEM hoses and clamps removed from the throttle body. The ends are labeled based on their connections at the throttle body.

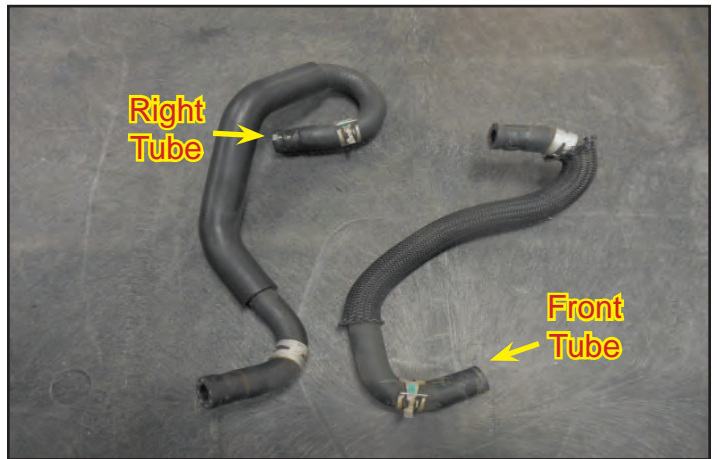

140. **Note: This step applies only to 2007-13 Tundra. Ignore this step if you have a 2014+.** Install the other hose to the front facing tube on the throttle body. Install the other end to the coolant cross over. Slide the clamps over the connections.



141. Note: This step applies only to 2014+ Tundra. Ignore this step if you have a 2007-13.

Connect the hose from the heated PCV valve to the throttle body where shown with the yellow arrow, and secure with a spring clamp. Hold hose in place with a cable tie (highlighted in green and shown with a green arrow).

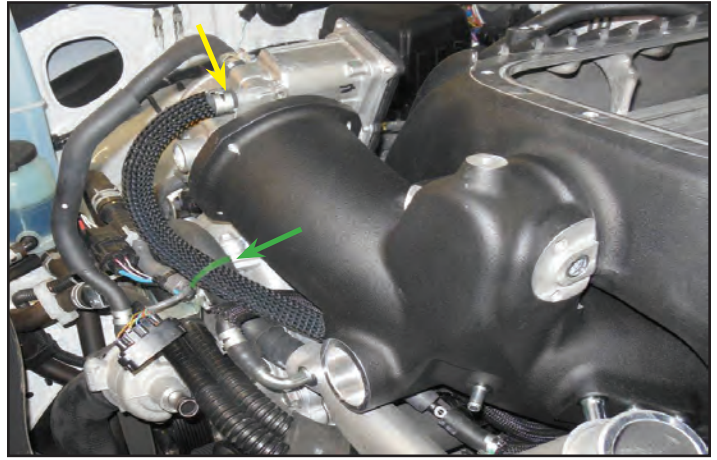

142. Note: This step applies only to 2014+ Tundra. Ignore this step if you have a 2007-13.

This diagram shows the heater hose routing for 2014+ Tundras with heated PCV valve. A larger version of this diagram is included at the back of this manual.

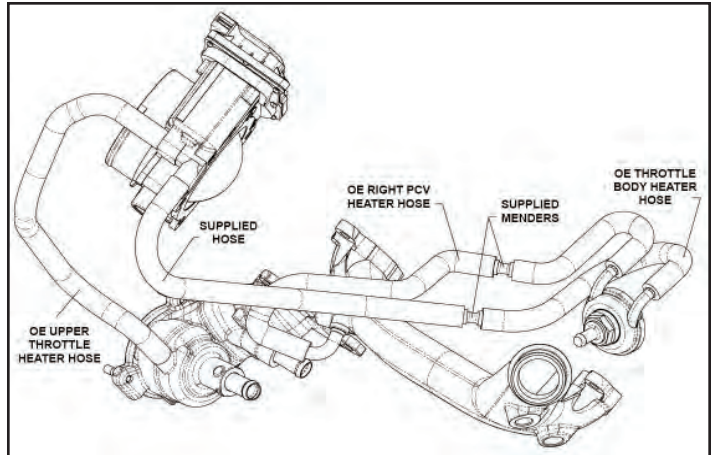

143. Install the provided air duct to the throttle body using the provided hose clamp.



144. Ensure that the notch in the air duct lines up with the location shown with an arrow on the throttle body.



145. Replace your air filter with the supplied air filter. Slide the supplied air box lid air meter section into the air duct, making sure the lid lines up with the base properly. Latch the four spring clamps to secure the lid in place (One clip is shown at yellow arrow). Plug in the MAF connection where shown with the red arrow.

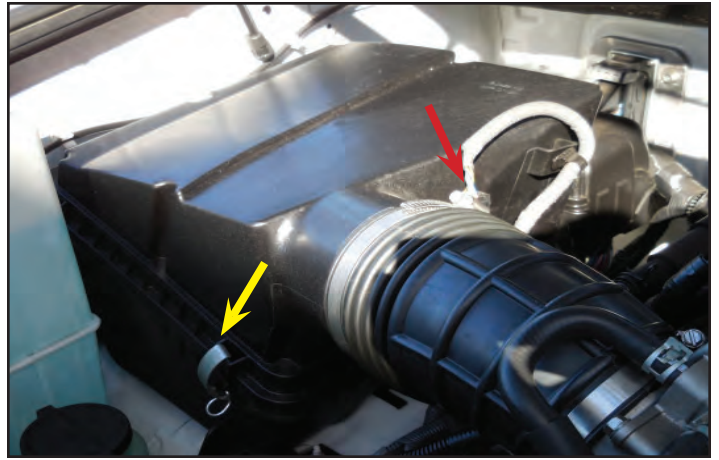

146. Install the hose from the fuel regulator to the air duct where shown with an arrow.



147. Remove the VSV and hose from the OEM intake manifold. Save the bolt (green arrow) for use in a later step.

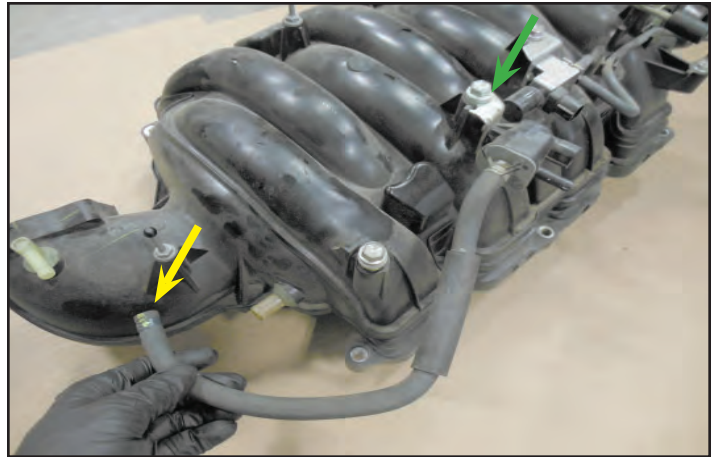

148. Remove the bracket from the VSV with a Phillips head screwdriver.

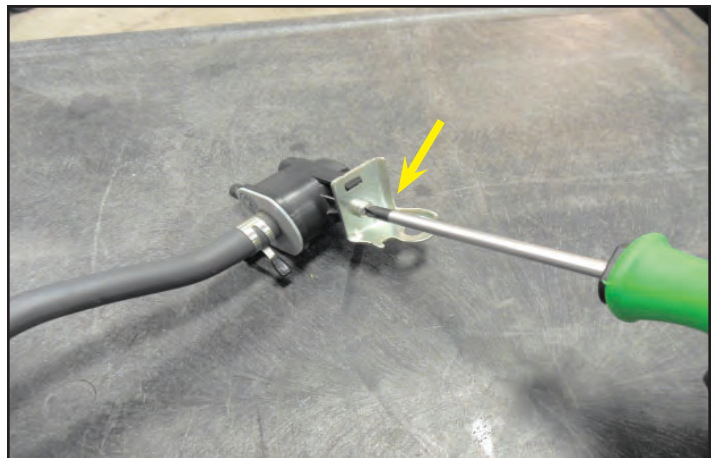

149. Install the VSV to the provided reservoir bracket using the supplied button head Allen screw and star washer.

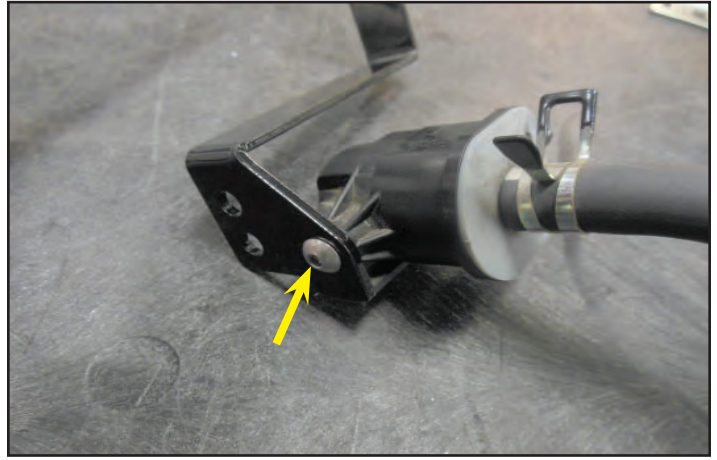

150. Gather the following supplied fasteners for the bracket. (2) M6 x 10 mm, (1) M6 x 16 mm button head and (1) M8 x 16 mm.



151. Secure the top portion of the reservoir bracket with one M6 x 16 mm length bolt, and one M8 x 16 mm length bolt. Do not fully tighten at this point.



152. Secure the lower portion of the reservoir bracket with two M6 x 10 mm bolts. Making sure the top of the bracket is touching the housing, tighten these button heads with a 3 mm Allen.

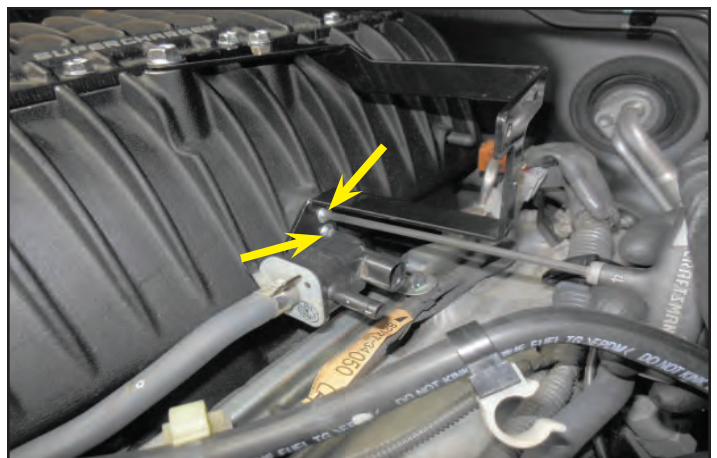

153. Torque the M6 bolts to 108 in-lbs, and the M8 bolt to 18 ft-lbs.



154. Remove the hose installed to the VSV and slide the 5 inch section of mesh sleeve on so that it covers the intersection of the hose (shown with a yellow arrow). Reconnect the hose at the purge valve and at the rear air tube of the supercharger (shown with a blue arrow), using the provided spring clamp. Slide the OE foam cover towards the blue arrow, protecting the hose from rubbing on metal.



155. Disconnect the brake booster line shown with the arrow. The spring clamps will be reused.



156. Gather the 37" mesh sleeve and the 26" section of $1\frac{1}{32}$ " brake booster hose. Slide the 37" mesh sleeve over the 26" hose. Gather the two OEM clamps removed from the brake booster line.



157. Connect the brake booster hose where shown with an arrow using one of the OEM clamps to secure it. Route the brake booster line under the A/C lines and coil pack electrical harness.

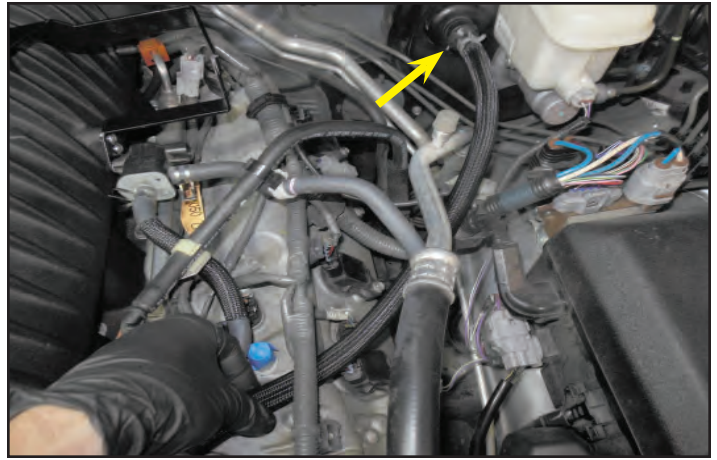

158. Connect the PCV line to the front air tube (shown with a red arrow) and secure with the provided spring clamp. Then connect the other end of the brake booster hose to the center air tube of the supercharger (shown with a yellow arrow).



159. Attach the provided dual swivel clip connecting the A/C hard line to the brake booster hose in the location shown with an arrow.

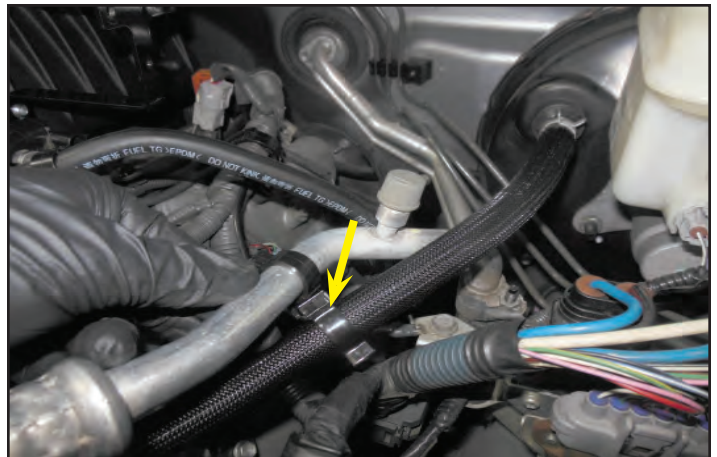

160. Disconnect the two hoses from the "T" fitting (shown with arrows). The longer hose on the right will be flipped and connected on the opposite end.

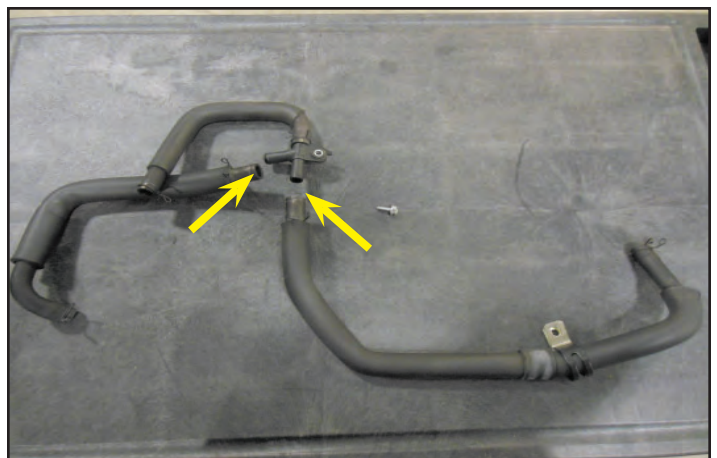

161. The longer hose on the right has been flipped and reconnected. Also the clamp has been repositioned as shown with an arrow.

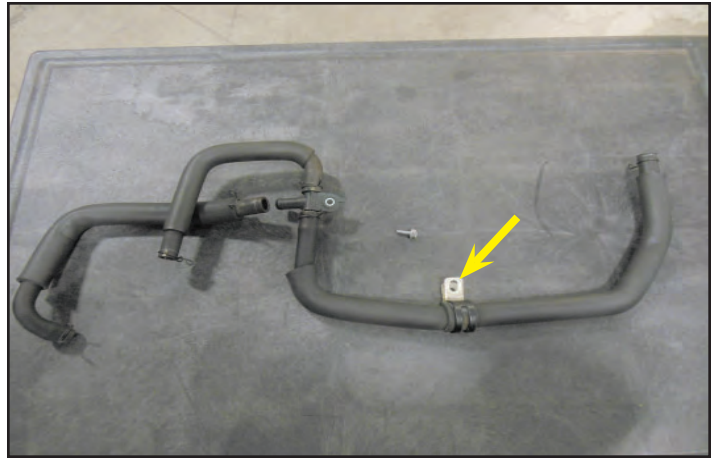

162. Remove one inch of hose from the end of the remaining hose shown.



163. Remove one inch of insulation from the shortened side of the hose to allow room for the OEM clamp to fit.



164. From the opposite side of the hose cut in the previous step measure 3" from the outside edge and cut the end of the hose off. Remove 1" of insulation from the end to allow the OEM spring clamp to be connected.

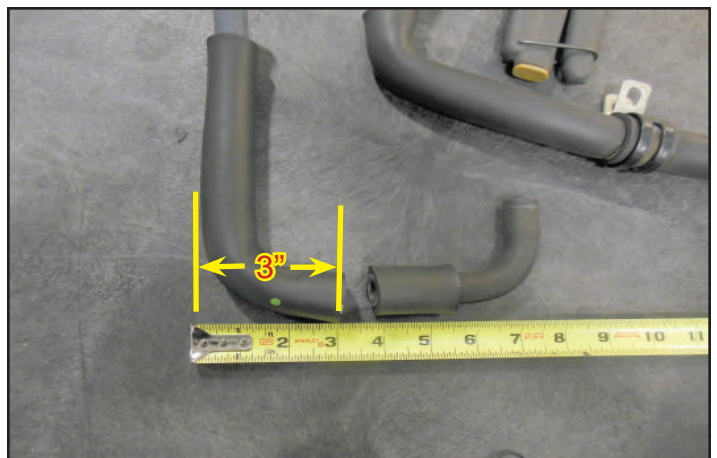

165. Reconnect the shorter hose in its original location with the short 90° end facing down. This photo shows the parts removed from the short hose as well. These will be discarded. The OEM M6 (shown with a red arrow) and M8 (shown with a blue arrow) are shown at their proper locations.

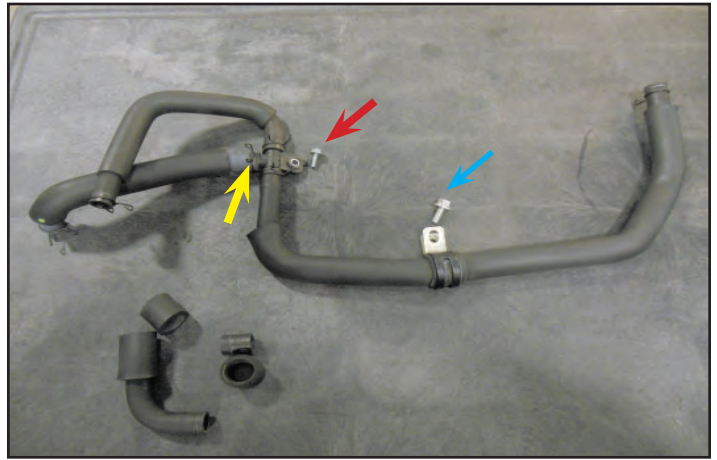

166. The OEM M8 bolt used to attach the ventilation hose assembly from the last step should be about 12 mm long. (This OEM bolt previously held the VSV bracket to the OEM intake manifold).



167. Install the ventilation hose assembly with the OEM fasteners in the locations shown with the arrows. **Torque the M6 bolt to 106 in-lb and the M8 bolt to 18 ft-lbs.** (Note: Face the clamp in the direction shown near the blue arrow).



168. Connect the longer hose of the ventilation assembly to the left valve cover location shown with an arrow.



169. Connect the unaltered hose of the ventilation hose assembly to the fitting on the air duct.

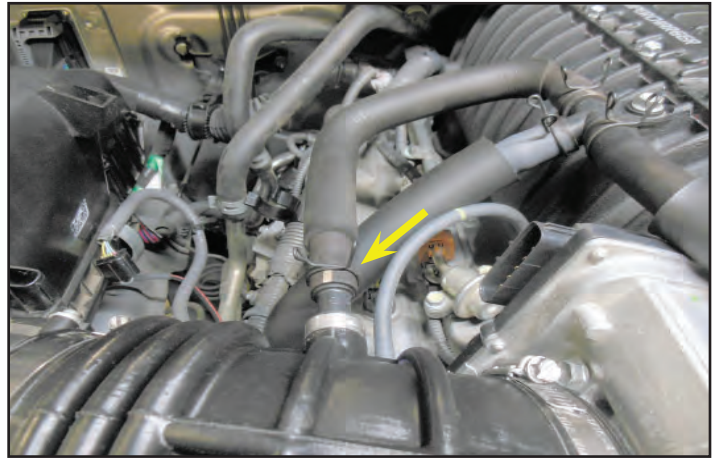

170. Connect the final end of the ventilation hose assembly to the right valve cover location shown with an arrow.

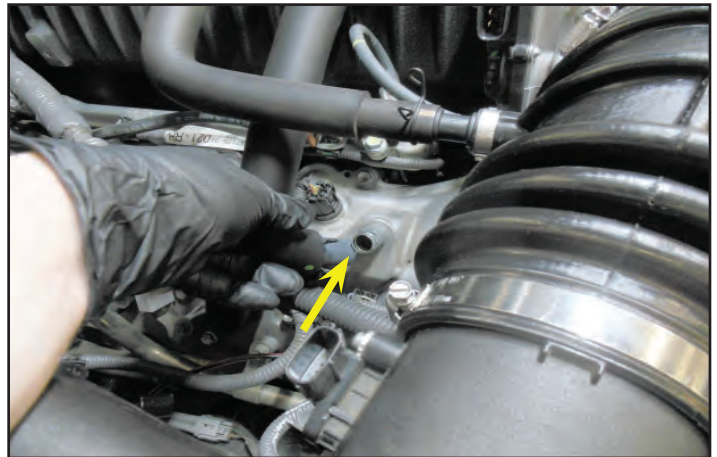

171. Reconnect the radiator hose. Flip this hose end for end from its original location. Earlier you should have marked the radiator end, This end should now be attached to the coolant crossover. The clamps in this picture are not shown in their final securing positions.



Section 9: Intercooler System Installation

172. **Note: This step applies only to 2014+ Tundra. Ignore this step if you have a 2007-13.**

Remove the four bolts at the yellow arrows locations. Disengage the two clip rivet fasteners at the red arrow locations by pulling up on the center first with a small screwdriver, and then pull up on the outside of the clip rivet.



173. **Note: This step applies only to 2014+ Tundra. Ignore this step if you have a 2007-13.** This photo was taken from the left side gap above the front bumper, and shows the tabs behind the radiator grille. There are two tabs on each side of the grille. The tab towards the rear (shown with the yellow arrow) must be pushed upwards. The tab towards the front (shown with a red arrow) must be pushed downwards. After these tabs are released on both sides you can pull the grille forward to remove it.

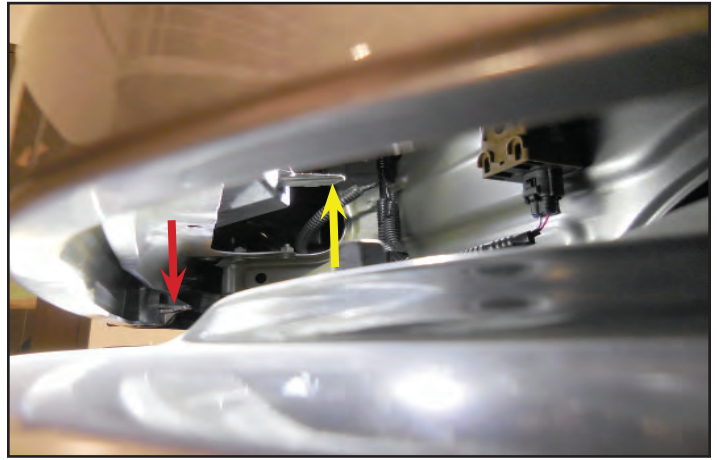

174. **Note: This step applies only to 2014+ Tundra. Ignore this step if you have a 2007-13.** Remove the nuts (2 each at the arrow locations) for the lower grille support. Now remove the grille support.

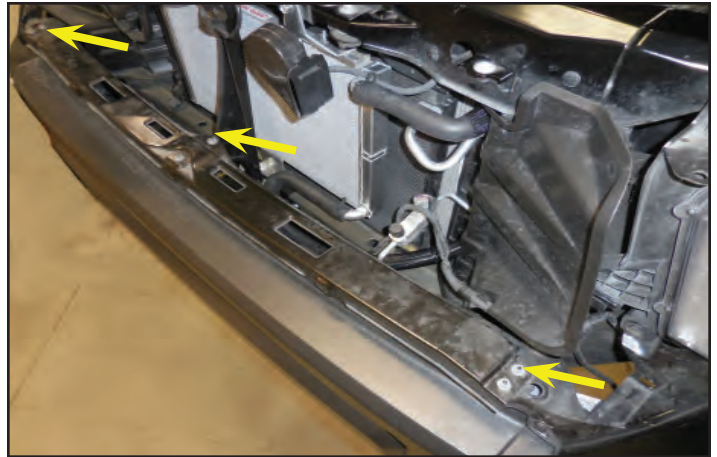

175. Unplug the electrical connection for the horns. Remove the bolt holding the horns in place and set the horns aside for reinstallation at a later step.



176. Remove the three rivets shown with arrows. Twist the head with a Phillips screwdriver to disengage it, then pull the rivet body out. Newer vehicles may have slightly different fasteners.

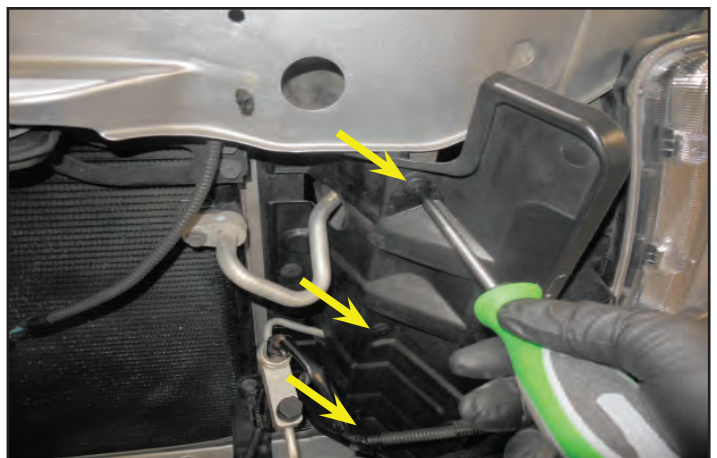

177. Disconnect the plastic clip holding the wiring assembly to the plastic shroud (shown with a yellow arrow). Unplug the A/C connector shown with a red arrow.



178. Unplug the ambient air temperature connector shown.

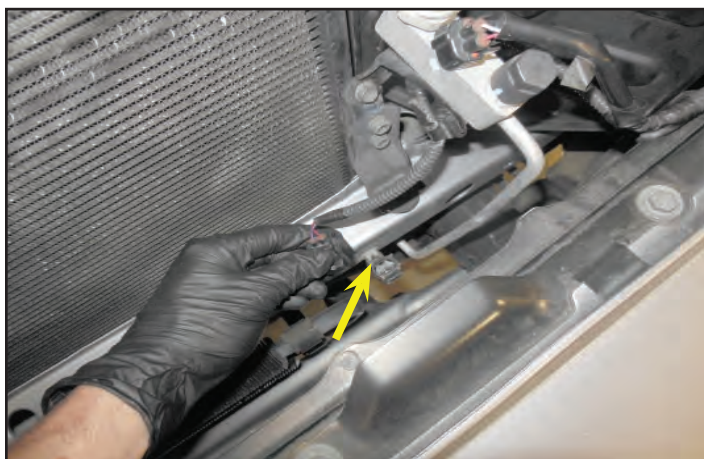

179. Disconnect the plastic clip holding the wiring assembly to the metal frame. The wire assembly should now be free. Move it temporarily toward the left side headlight.



180. Remove the “tree” rivets holding the left side radiator shroud in place.

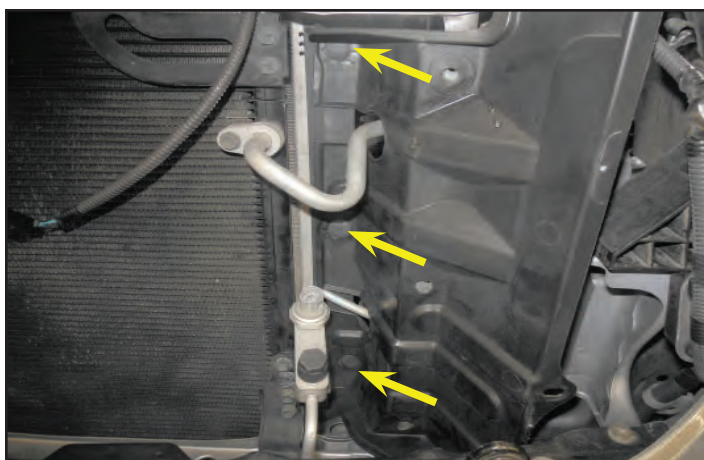

181. The rivets are easier to remove if you push the back side of them through.



182. Remove the left side radiator shroud. This will be modified and reinstalled later.



183. Install the provided LTR/Pump bracket behind the center vertical brace, and in front of the radiator.



184. Install the provided rectangular bodied M8 nuts behind the lower radiator cross beam. These will be used with a bolt to secure the LTR/Pump bracket. There is another location at the left side of the bracket for the other nut and bolt.



185. Install the M8x20mm bolt through the front while holding the rectangular bodied nut shown in the previous step and tighten it in place. Repeat this process on the left side of the bracket.



186. Gather the Low Temperature Radiator (LTR). The LTR is shown with its mounting brackets.

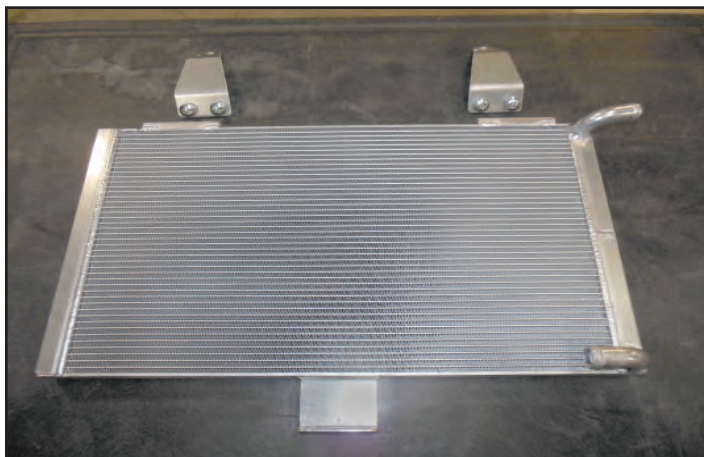

187. Gather the upper mounting brackets along with the nuts and shoulder bolts shown. These will be attached to the LTR in a later step. Insert the bolts from below and attach the nuts from above as shown on the bracket to the left in this photo. Keep these bolts loose for installation in a later step.



188. Slide the LTR in front of the A/C condenser and behind the vertical support. Be careful not to damage the cooling fins on the condenser, or the LTR. Align the two holes in the lower bracket with the studs from the bracket attached behind the center vertical brace.

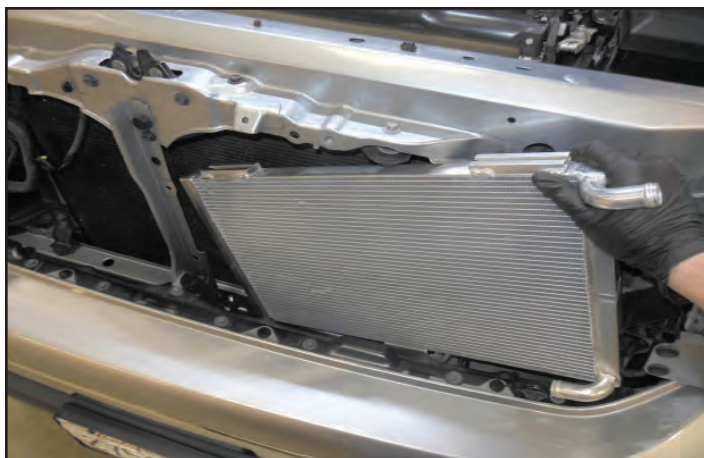

189. Slide the bracket with nuts and bolts attached loosely into the channels on top of the intercooler.



190. Align the bracket so its hole lines up with the threaded hole used to mount the horns (shown with an arrow). Tighten the nuts to maintain this alignment. Repeat this on the opposite side of the LTR.



191. Fasten the lower bracket of the LTR to the two studs from the bracket behind the center vertical brace using two nuts.

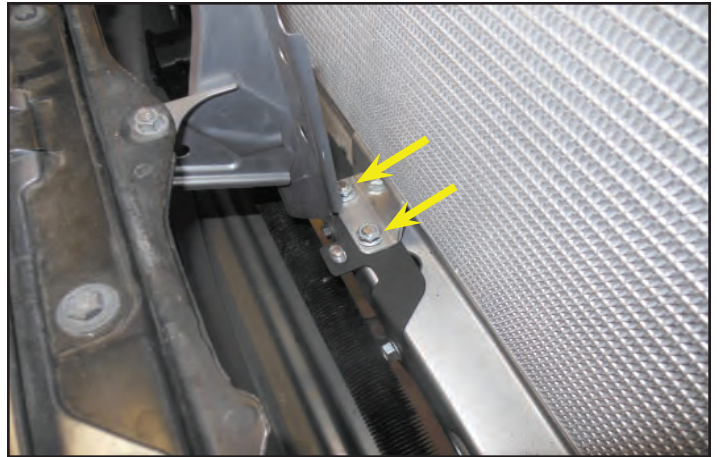

192. Re-attach the two horns at their original locations using the provided M8 x 20 mm bolts. Plug in the electrical connections to both horns.

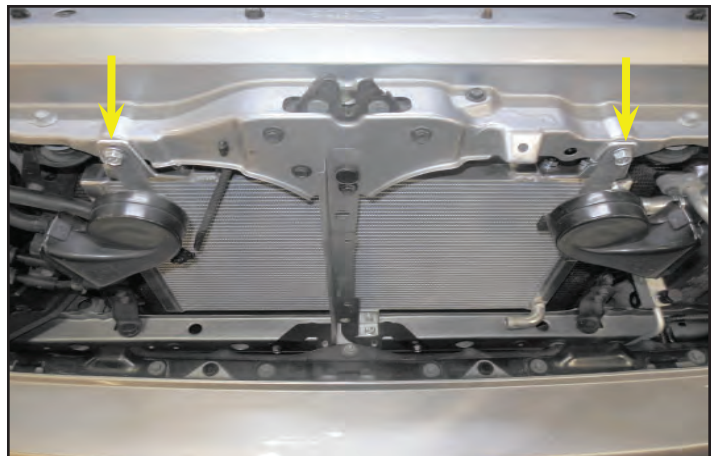

193. Gather the two Adel clamps and install them on the intercooler pump as shown. Remove the plastic caps from the input and output ports of the pump.

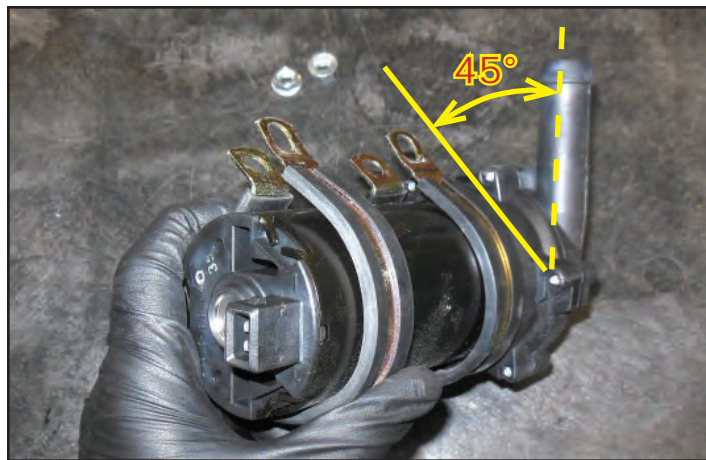

194. Install the intercooler pump at the two front studs on the bracket located in front of the vertical radiator brace. Using two provided M8 nuts, secure the pump, making sure the outlet barb stays at around 45° pointing towards the LTR.



195. Gather the OEM left radiator shroud removed earlier, and remove the areas highlighted in yellow. You can drill out the corners then use a Dremel or razor to cut out the rest. Remove all sharp edges. Reinstall the modified radiator deflector in its original location with the OEM rivets.

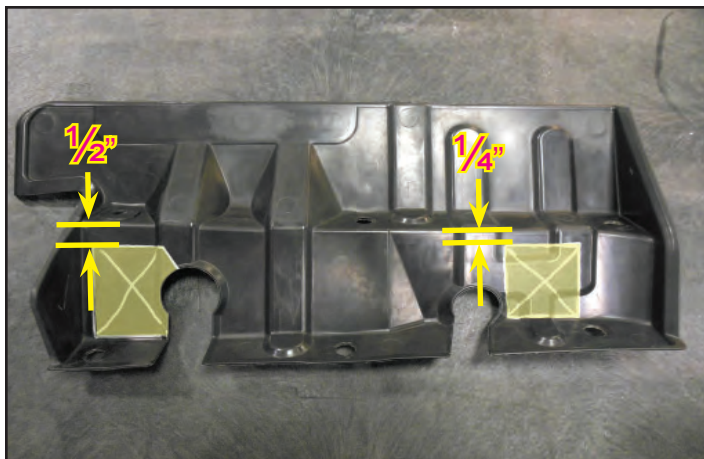

196. Cut the provided coolant hose shown 4" from the outside edge. Both pieces will be used. Make sure to check your measurement.

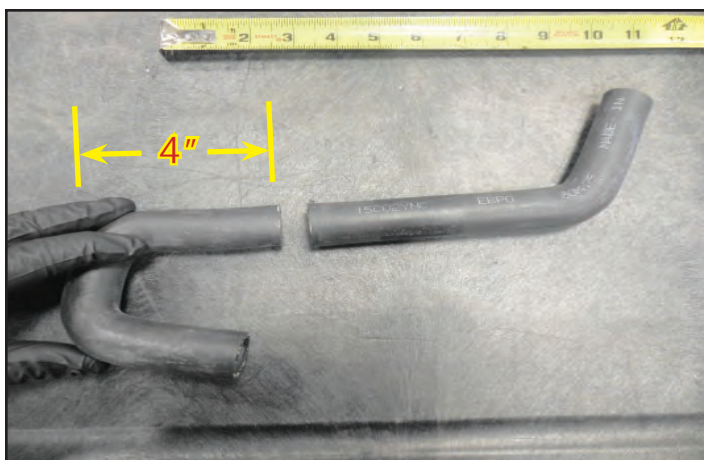

197. Cut the opposite side of the hose from the last step 3" from the outside edge.

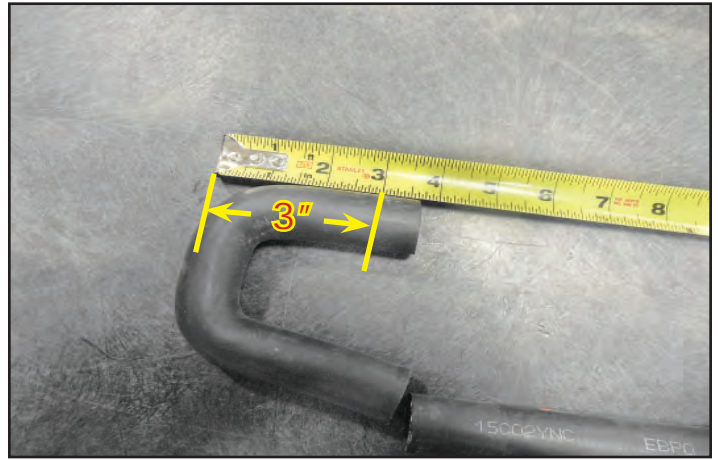

198. Gather the following 4" x 60" 90° hose.

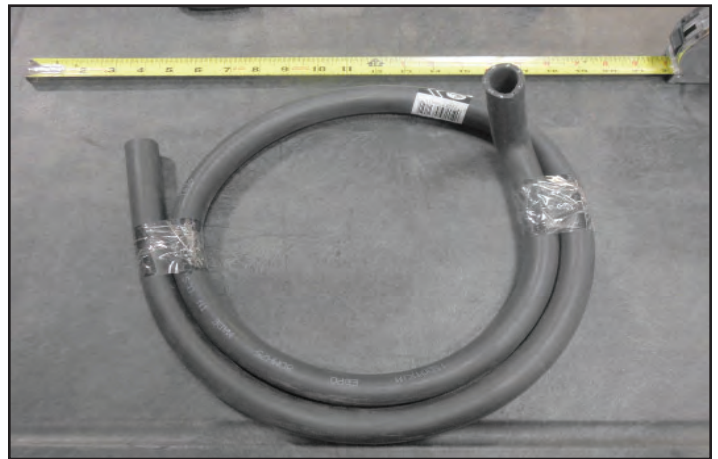

199. Make a cut 6.5" from the outside edge of the hose. The remaining straight piece will be used in a later step.

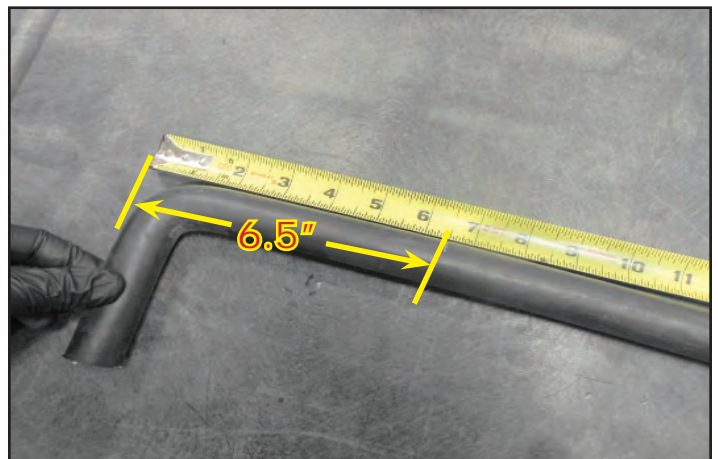

200. Cut the opposite end of the 90° piece of hose from the last step to 4" from the outside edge.



201. Cut the remaining straight piece from previous steps to 44".

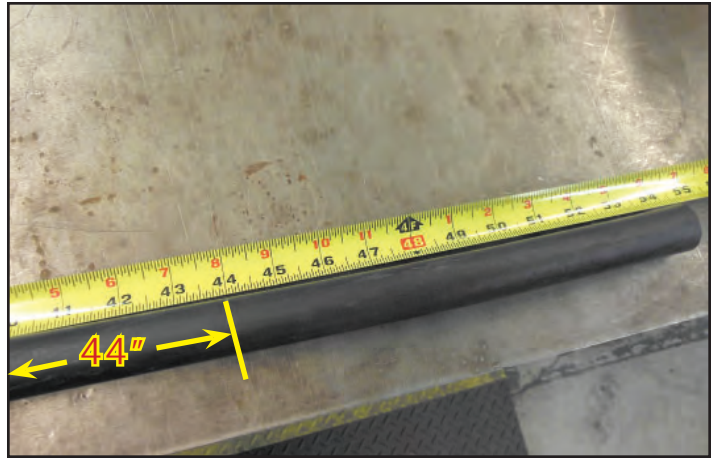

202. Gather the following parts. This included the hoses cut in the last few steps, 4 shrink clamps, two hose menders, and a 54" piece of mesh sleeve.



203. Compress the shrink clamps to crush the cardboard inner sleeve. Then push the cardboard sleeve out.



204. Slide the 54" mesh sleeve over the 44" hose. Offset the mesh sleeve to one side as shown. Install a plastic hose mender on the end where the mesh is further away.

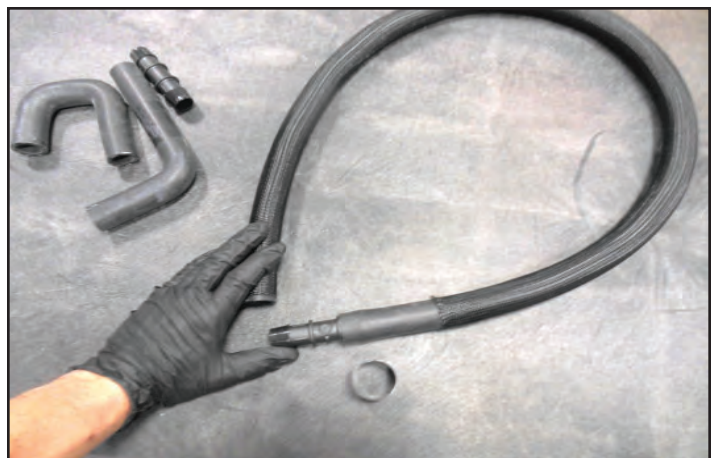

205. Press the hose mender on until it hits the stop. Place the shrink clamp $\frac{1}{8}$ " from the end of the hose. Use a heat gun to shrink the clamp around the hose. Move the heat continuously around the clamp to avoid distortion.

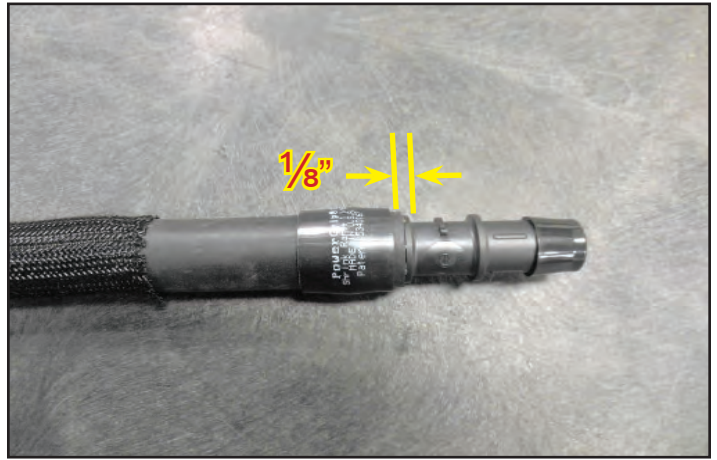

206. Slide the shrink clamp on the longer end of the "U" shaped hose, and press the opposite side of the mender until it contacts the stop. Shrink the clamp in place $\frac{1}{8}$ " from the end.



207. Assemble the opposite end of the 44" hose using a hose mender, two shrink clamps and the 3" mesh section along with the 4" x 6.5" 90° hose. Follow the same procedure as before for installing the shrink clamps. Install the 4" side onto the mender. Push the 3" mesh up to the edge of the shrink clamp. Refer to the photo in the next step for proper end to end orientation.



208. Here is the completed hose from the last few steps.



209. Place the 9" length mesh sleeve over the 45° hose cut earlier. Leave enough room at each end for clamps.

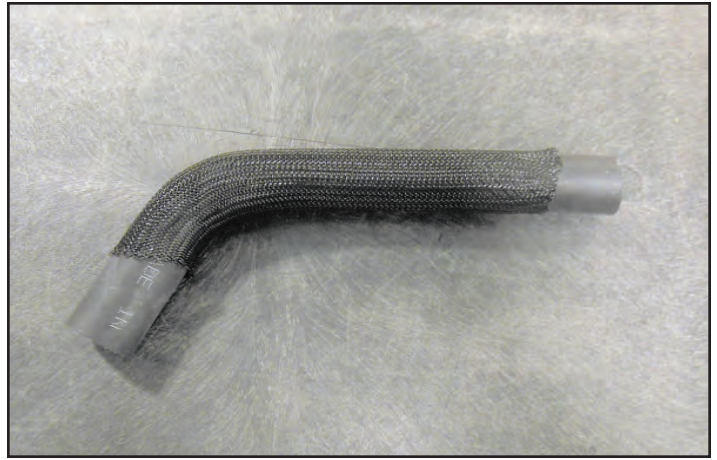

210. Gather the second piece of 4" x 60" 90° hose. Cut the hose to 7" from the outside edge. Save the straight section for a later step.

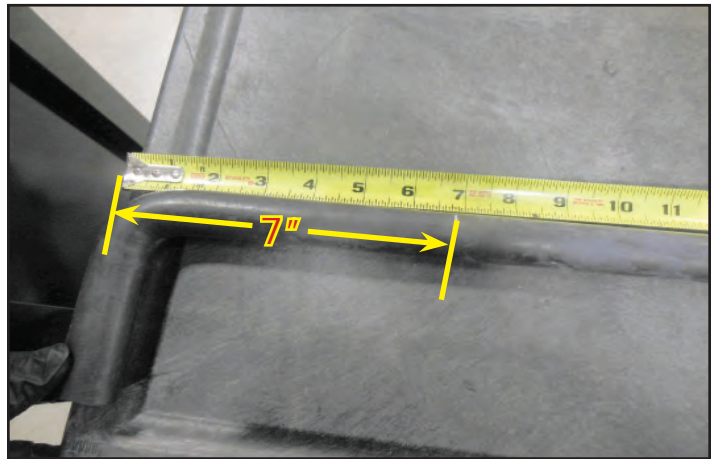

211. Cut the opposite end of the 90° piece of hose from the last step to 2.5" from the outside edge.

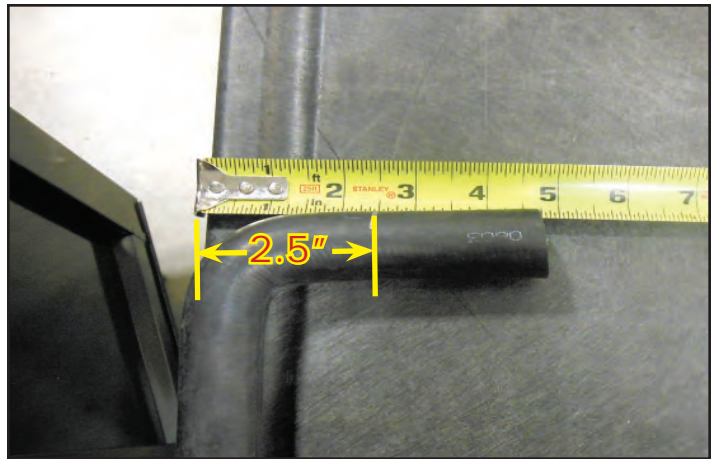

212. Cut the remaining straight section from the last step to 49.5".

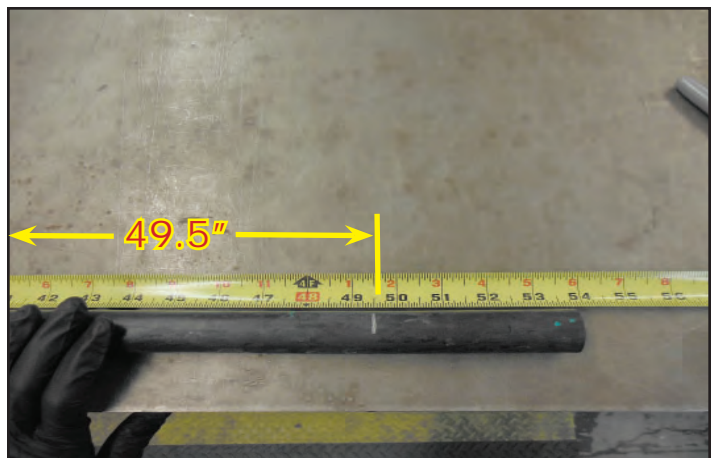

213. Slide the second 54" mesh on the 49.5" hose that was cut in the last step. Offset the mesh to one side as shown in the photo.



214. Install the 2.5" x 7" 90° hose between the intercooler pump and the lower spigot of the LTR as shown. Use the provided spring clamps. If necessary loosen the pump mounts to allow proper hose alignment.

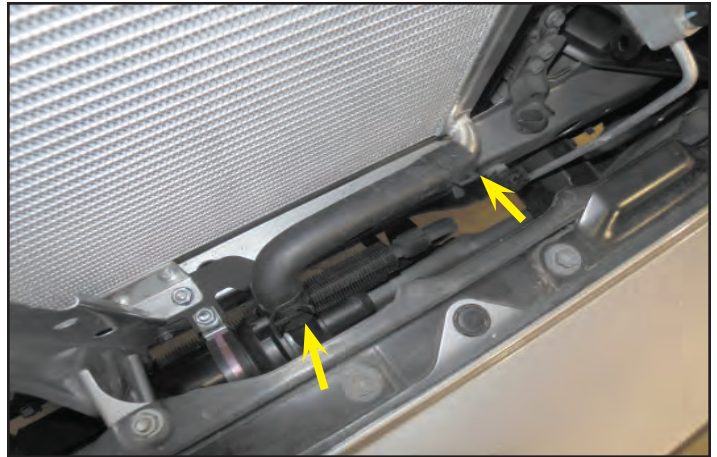

215. Install the intercooler reservoir on the bracket installed to the supercharger using the provided bolts.

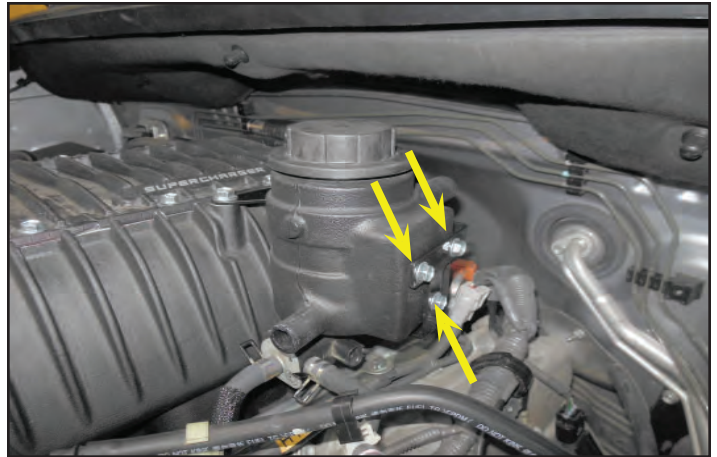

216. Install the 49.5" straight hose to the lower reservoir spigot using a provided worm gear clamp. It's important to utilize only worm gear clamps on the intercooler reservoir. Use the end of the hose with the mesh closest to the end for this connection. Make sure to pass the other end under the A/C hose as shown in the picture.



217. Route the hose from the last step down near the battery tray, and to the left side of the A/C line as shown with an arrow.



218. Continue routing the 49.5" straight hose from the last step through the lower cutout of the left radiator shroud, and in front of the LTR as shown.



219. Install the end of the 49.5" straight hose to the spigot of the intercooler pump (shown with an arrow). Use a provided spring clamp.

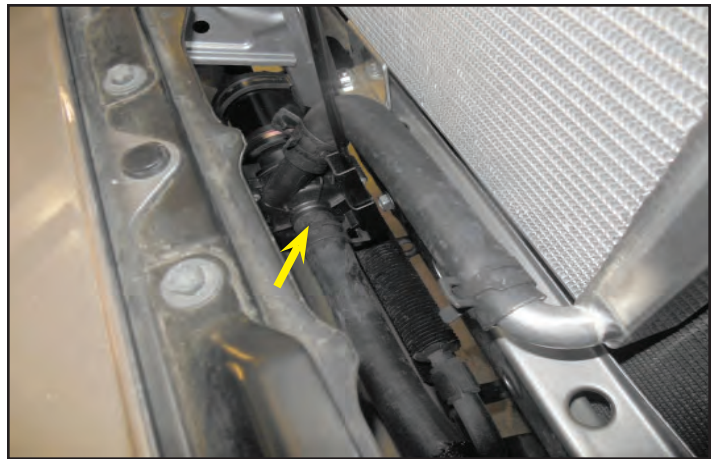

220. Pre-install the spring clamp over the 45° hose shown that has the mesh installed. Make sure the hose and clamp are oriented as shown.

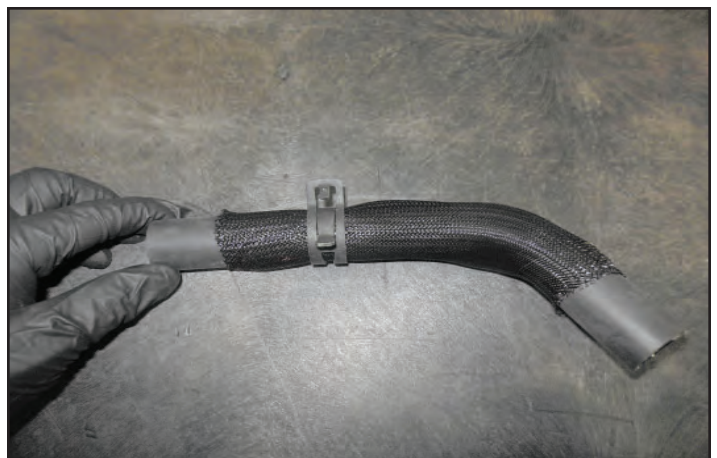

221. Install the end of the hose from the last step with the spring clamp at the point shown with an arrow. Attach the opposite end of the hose to the upper spigot of the reservoir with a worm gear clamp.



222. Route the hose assembly with the 4" x 6.5" 90° section under the A/C line, and fuel line as shown.



223. Continue to route the 4" x 6.5" 90° section of the hose assembly from the last step through the upper cutout of the left radiator shroud.



224. Connect the 90° section of the hose assembly from the last step to the upper spigot of the LTR (shown with an arrow). Secure with a provided spring clamp.

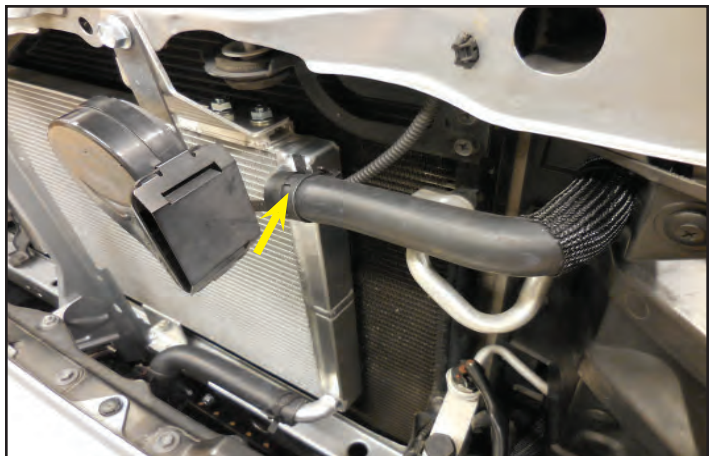

225. Pre-install a provided spring clamp on the opposite end of the hose assembly from the last step (shown with an arrow).



226. Route the opposite side of the hose assembly from the last step around the back of the supercharger and attach it at the right rear of the supercharger using a spring clamp (shown with an arrow).



227. Gather the two dual hose tie wraps shown in the top image. The bottom image shows how to route the dual hose tie wrap. **Do not engage the zip tie in this step.**



228. Use one of the dual hose tie wraps at the point shown with an arrow. Do not overtighten. The zip tie should not crush either hose.



229. Plug the connector with the blue and black wire to the VSV (shown with the yellow arrow). The ACIS connector (shown with a red arrow) will be sealed with electrical tape in the next step. The connectors are "keyed" so you can not plug the wrong one in.



230. Seal the ACIS connector with electrical tape and wrap it to the wire harness as shown.

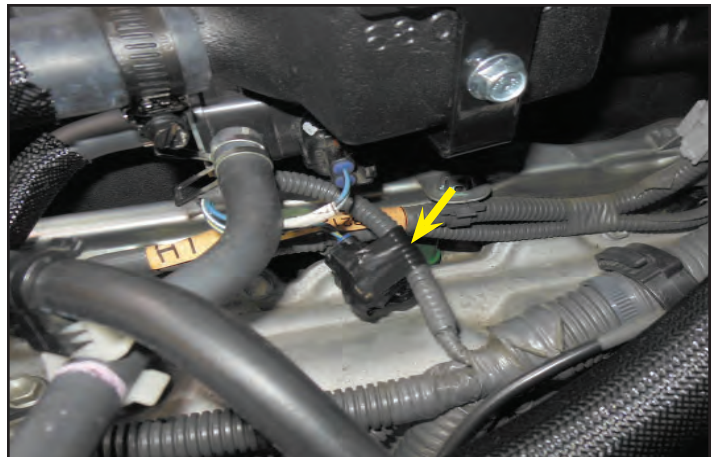

231. Gather the two large tie wraps, and the swivel spacer shown.

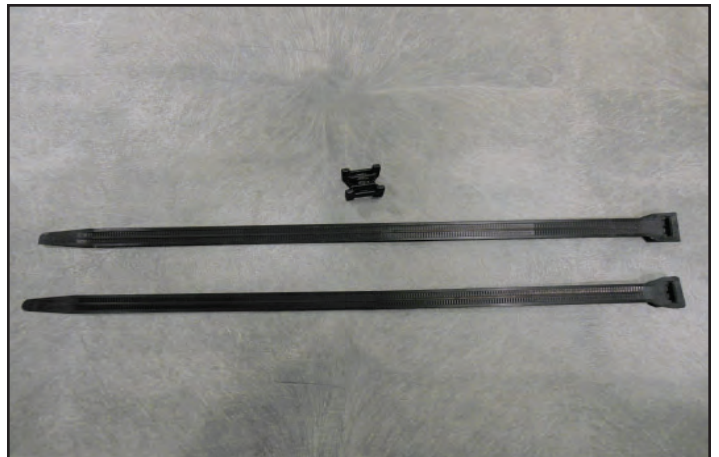

232. Slide the tie wraps from the last step through the swivel spacer to allow the connection of the two hoses shown with an arrow. **Do not crush either hose with the tie wraps.**



233. Use the second dual hose tie wrap to secure the two hoses at the location shown at the front of the left valve cover. The tie wrap is shown not fully secured for visual clarity.

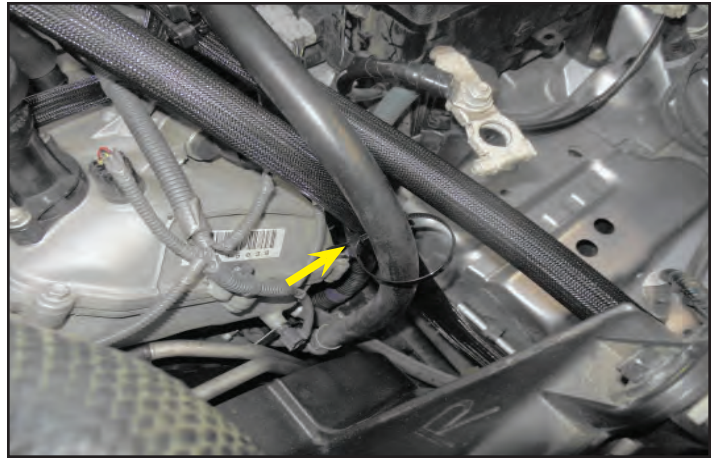

234. Plug in the two electrical connections (shown with yellow arrows), and press the plastic wire harness clips back into their slots (shown with green arrows).

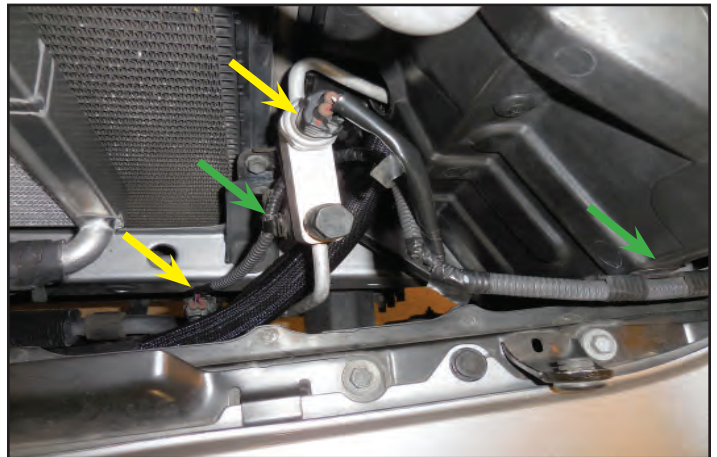

Section 10: Intercooler Pump Wiring Connections

235. Using a 10 mm socket remove the bolt at the location shown with a yellow arrow. Also remove the two bolts (shown with green arrows) that hold ground wires.

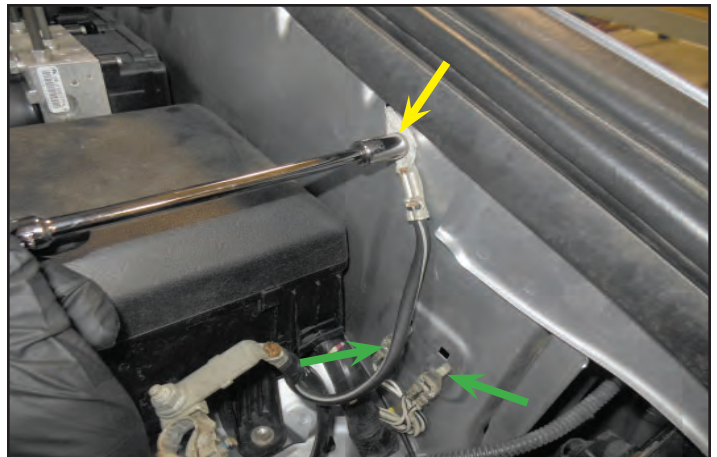

236. Gather the provided relay wiring harness. It will be used in the next few steps. Install the provided harness bracket shown using the two bolts removed from the ground wire locations (shown with green arrows), and reinstall the ground wires. Incorporate the ground wire for the provided fuse holder with the bolt shown on the right. Install the fuse holder with a supplied nut (shown with a yellow arrow). Make sure the tabs on the two ground wires pass through the bracket and inner fender wall.

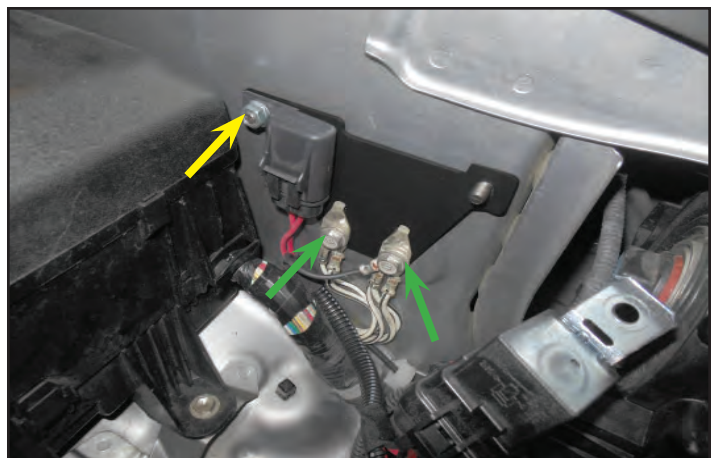

237. **Note: This step applies only to 2014+ Tundra. Ignore this step if you have a 2007-13.**

You may not be able to feed the yellow trigger wire though the location shown in the following steps. If that is the case you will need to notch the edge of the fuse box to allow clearance for the wire once the lid is closed. Make that notch in the area shown with a red arrow. Allow enough clearance for the wire to avoid contact with the lid.

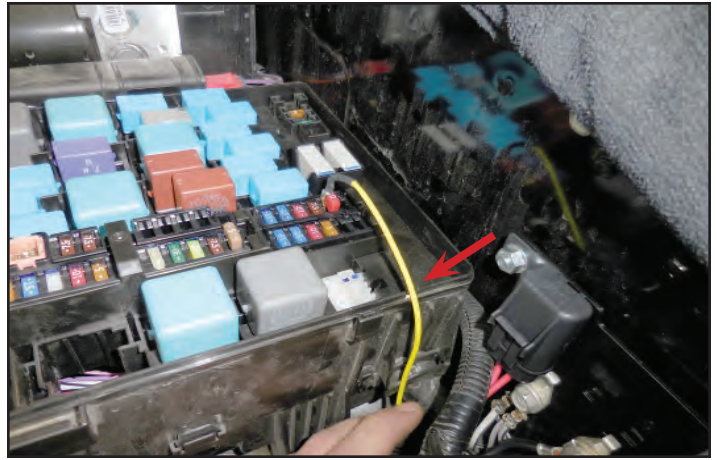

238. Secure the relay with a supplied nut (shown with a yellow arrow). Start feeding the yellow trigger wire into the fuse box where shown with the green arrow.



239. Continue to feed the yellow wire through the area shown with a yellow arrow using needle nose pliers. This will be attached to a fuse in a later step.

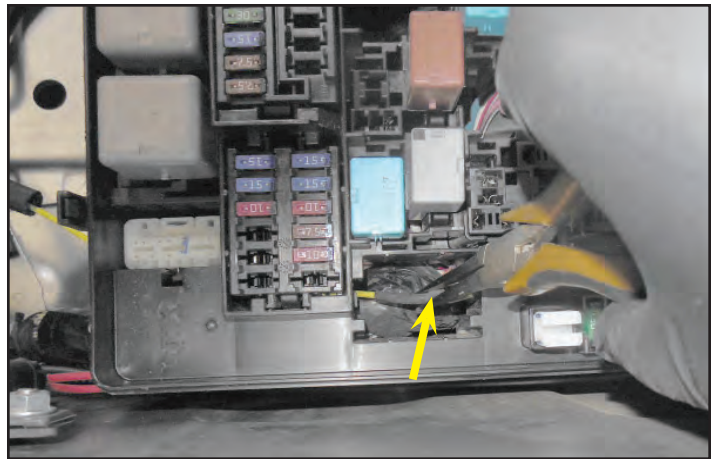

240. Secure the relay wiring harness to the wires going into the fuse box (shown with a red arrow). Make sure you have fed the yellow trigger wire all the way into the fuse box. The loom should touch the fuse box (Shown with green arrow.)

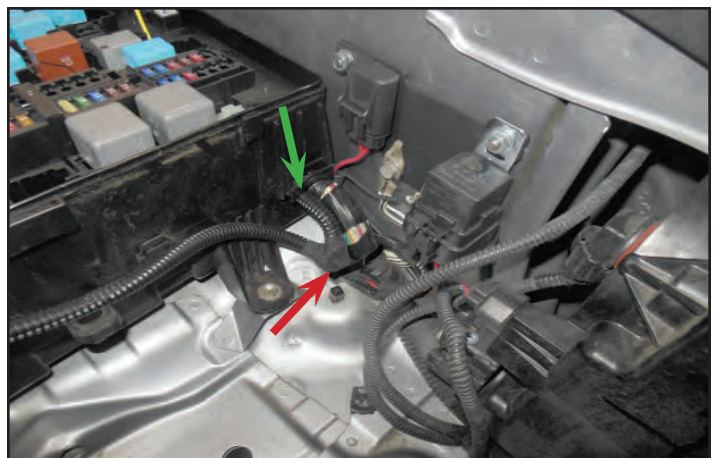

241. Reinstall the ground wire shown with the OEM bolt.



242. Install a cable tie around the relay wiring harness and through the hole in the fuse box (shown with a yellow arrow). Cable tie is shown uncut for clarity. Trim the excess cable tie. **Note: The joint where the red wire exits the loom should line up with the edge of the fuse box (shown with a red arrow).**

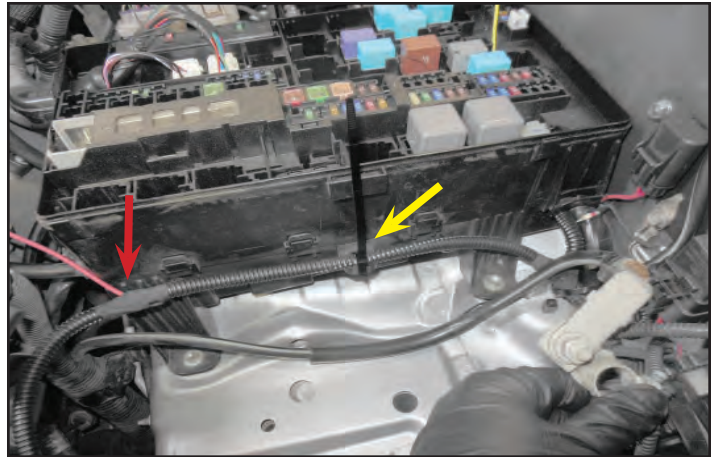

243. Install cable ties around the relay wiring harness and adjacent wiring harness and hard lines located at the yellow arrows. Trim the excess cable tie.

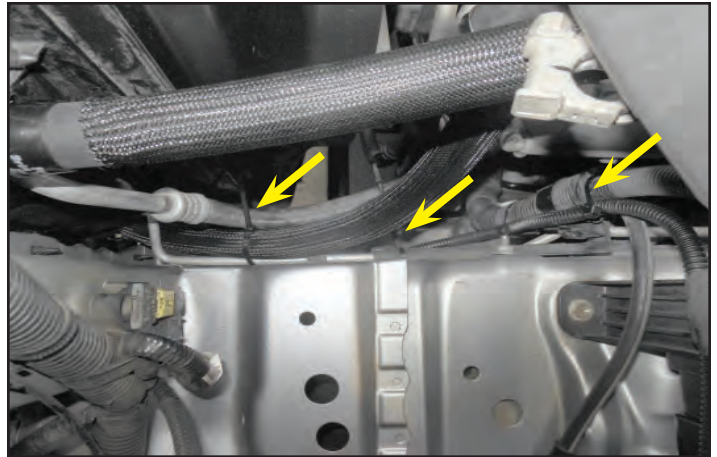

244. Route the relay wiring harness through the lower cut out in the left radiator deflector, following the hose leading to the pump inlet.



245. Connect the end of the relay wiring harness to the intercooler pump. Use a cable tie to secure the wiring harness to the pump at the location shown. Trim the excess cable tie.

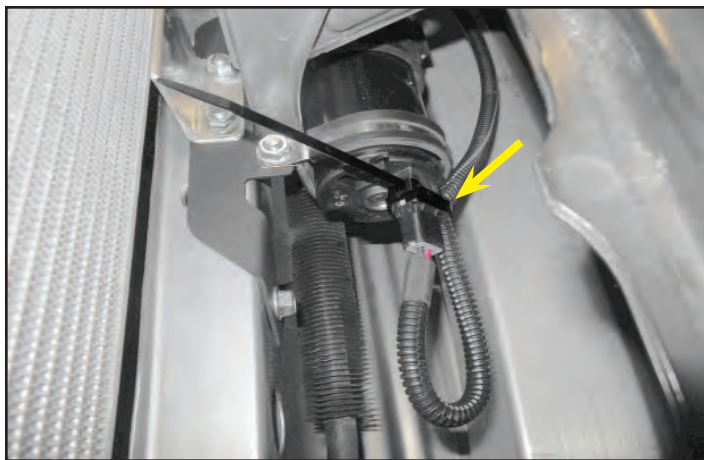

246. Install a cable tie at the location shown to secure the wiring harness to the hose. Bundle up any excess harness at this location.

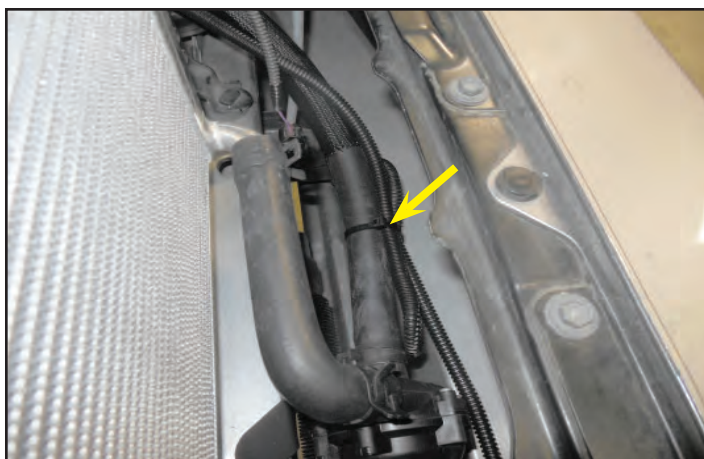

247. Reinstall the battery, and tighten down the positive lead. **Do not connect the negative lead.** Install the red lead from the provided relay wiring harness to the positive lead of the battery (shown with a yellow arrow). Cover the red wire with the provided piece of 1/2" loom incorporating the positive battery lead. Wrap the joint with electrical tape (shown with a green arrow).



248. Remove the 10 amp fuse in the location shown. This is the closest fuse to the left fender. This fuse will be replaced. The fuse is labeled as "IGN" or Ignition. Verify you have removed the correct fuse by following the diagram on the underside of the fuse box lid.



249. Install the provided 10 amp fuse over the metal terminal on the yellow wire that was routed into the fuse box in an earlier step. This will trigger the intercooler pump to turn on.

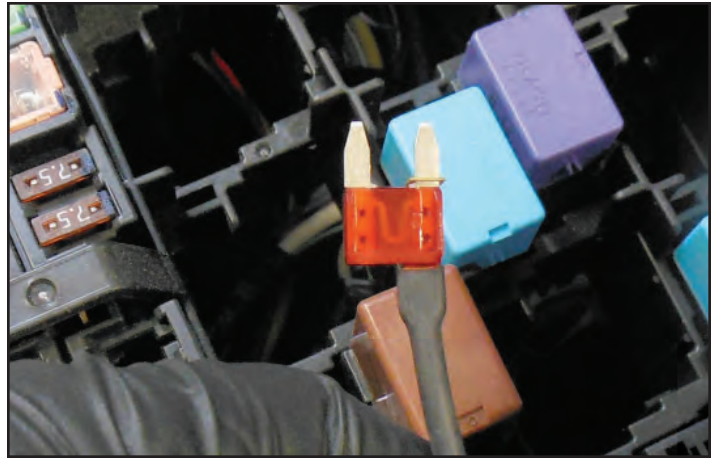

250. Insert the fuse which was attached to the yellow wire in the last step back into the location where the OEM 10 amp fuse was removed. Again double check you have replaced the fuse in the correct location.



251. Insert the 15 amp fuse into the fuse holder that was installed on the left fender wall. This is an in line fuse to protect the intercooler pump. Ensure that all wires are out of the way before closing the lid to the fuse box.



Section 11: Fuel Pump Replacement

Refer to the owners manual for proper lifting of vehicle. Ensure that the vehicle is properly supported while working under it. Failure to properly support the vehicle may result in injury or death.

252. Raise the vehicle to access the fuel tank. If required, remove the fuel tank protector by removing the 2 bolts & 2 nuts.



253. Find the fuel lines shown that will be disconnected.



254. Have rags ready to soak up any excess fuel before disconnecting. Disconnect the fuel feed and return lines (shown with yellow arrows). Lift up on the cover to detach the safety lock. Now pinch in on the two sides and pull the line loose.

Take care not to damage these connections. If these lines get kinked, they will need to be replaced.

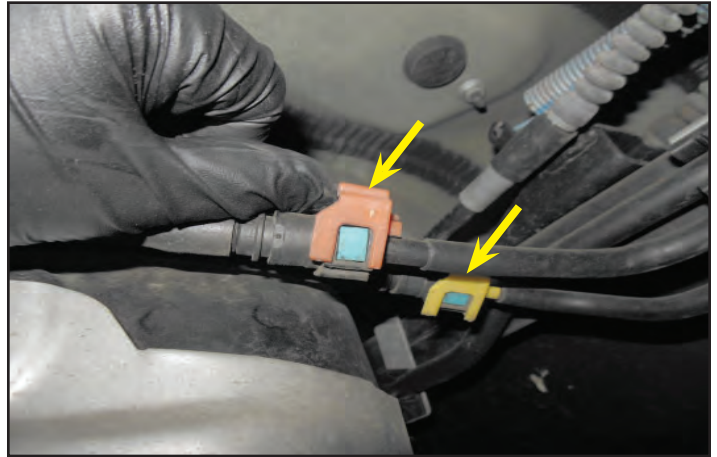

255. Pull outward on the retainer clip to disconnect the vent hose.



256. Disconnect the wire harness clip from the top side of the fuel tank.



257. Disconnect the two hoses shown with yellow arrows. You may have to remove the hose shown with the blue arrow as well. For reference the green arrow is pointing to the backside of the fuel tank filler neck.

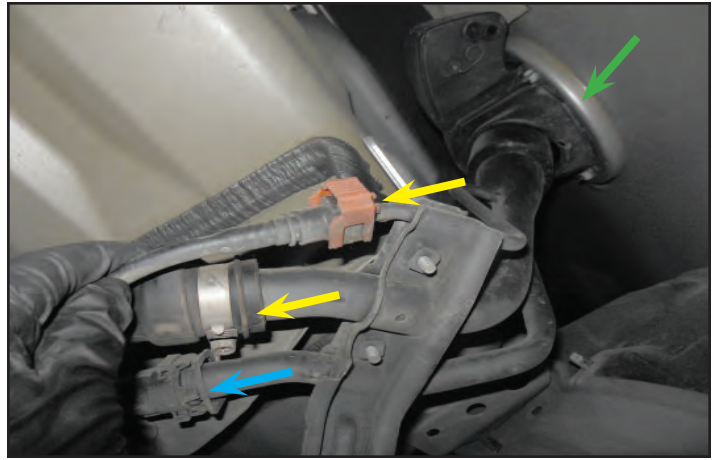

258. Follow the three lines you just disconnected back to the frame rail and release them from the retaining clips.

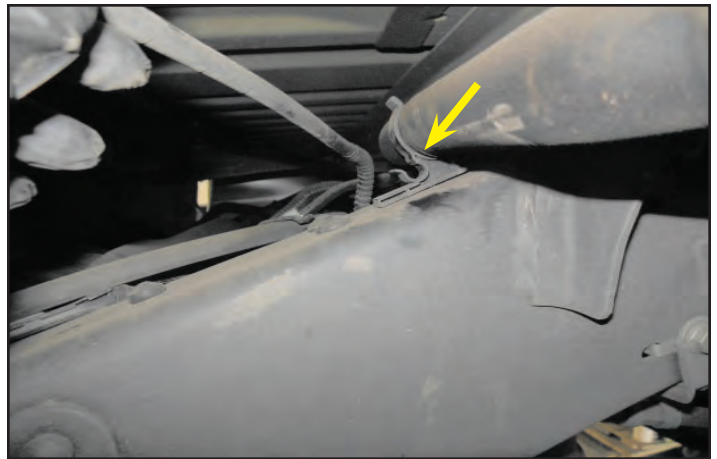

259. Support the fuel tank with an appropriate stand. Unbolt the two tank bands. **Make sure the tank is properly supported.** Once you remove these two bands the tank can drop down.



260. Remove the pins from the opposite side of the straps and remove both bands.



261. Remove harness clip located at the top of the tank. This clip is located on the upper left side of the tank near the frame rail. You may need to drop the tank an inch or two to access this clip.

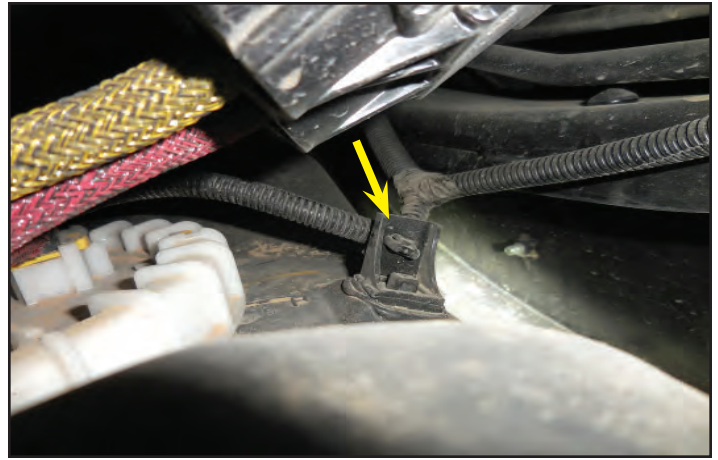

262. With the center harness clip disconnected slowly lower the tank. Stop after the tank has been lowered about 6 inches. You will have to reach back on top of the tank and remove the plastic cover on top of the fuel pump assembly.



263. Here is the cover that was just removed from the top of the tank.



264. Unplug the electrical connection for the fuel pump from under the cover that was just removed. This should be the last connection to the fuel tank. Continue to slowly lower the tank making sure it does not pull on any surroundings as you lower it.



265. Thoroughly clean and blow out any debris from around the fuel pump assembly.

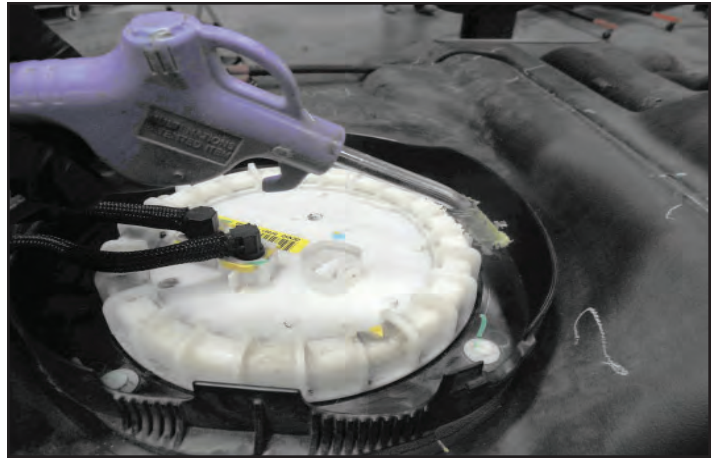

266. Remove the joint clip from the two fuel tank fittings. Then pull the fuel tank fittings out. Wrap the ends in a rag and gently move them out of the way.



267. Use a fuel tank lock ring tool to remove the outer lock ring. As you loosen the ring you will have to unclip the three lock tabs on top of the pump assembly every 1/3 rotation. **Do not damage these lock tabs.**



268. Remove the fuel pump assembly from the tank along with the O-ring. Discard this O-ring since a new one is supplied. Cover the tank opening to prevent debris from falling inside it.



269. Unplug the two wire connections shown with green arrows.

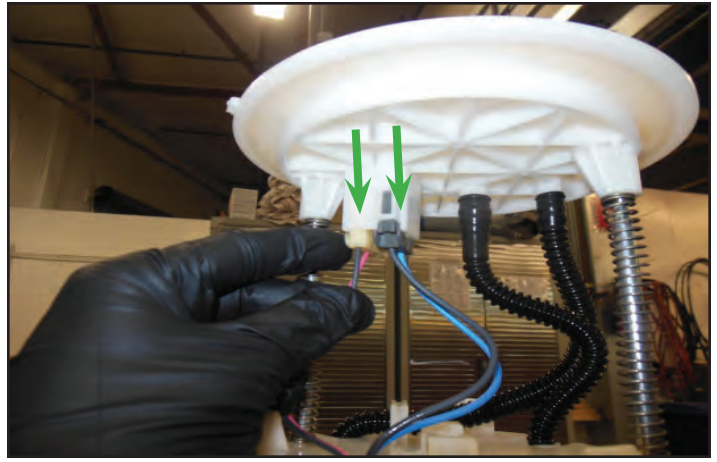

270. Press in on the sender gauge claw (shown with a red arrow) and pull up on the sender gauge to remove it. Unplug the fitting shown with the yellow arrow. Also unclip the red/black wires from the grey clip which runs to the sender gauge sensor. Set the sender assembly aside on a clean surface.

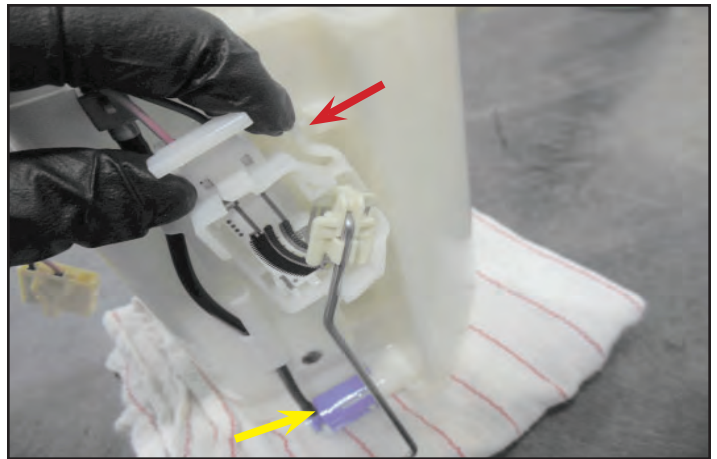

271. Pull the wire loom away from the clip shown with an arrow.

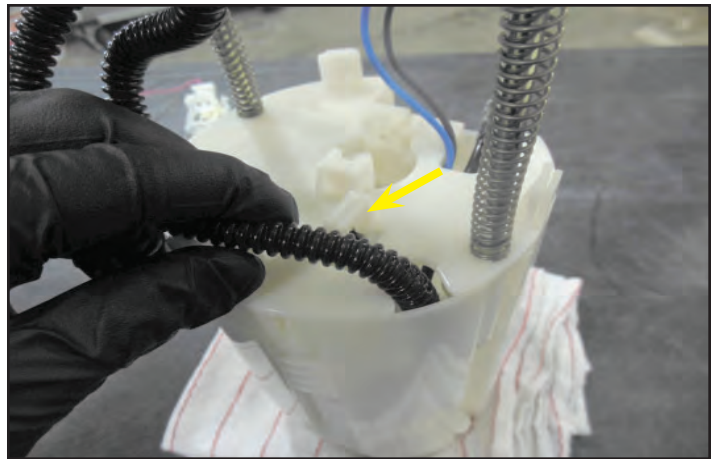

272. Lightly pry the 3 claws (shown with red arrows) away from the housing to remove the top. Lightly pry the two claws (shown with yellow arrows) to detach them from the sides.

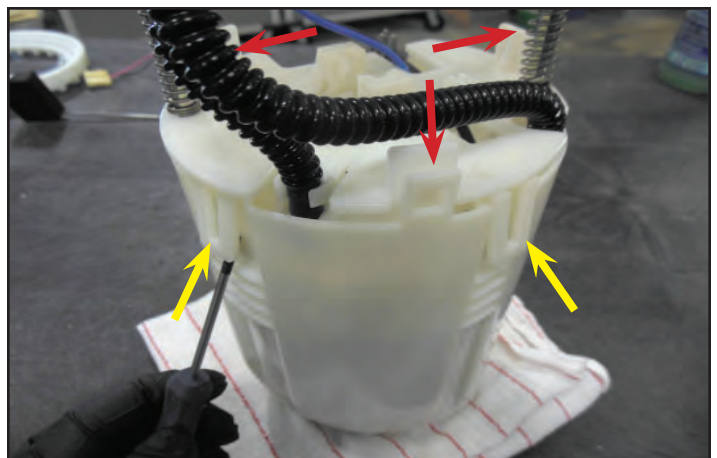

273. The upper lid from the housing is shown being removed. Set it upside down on the table.

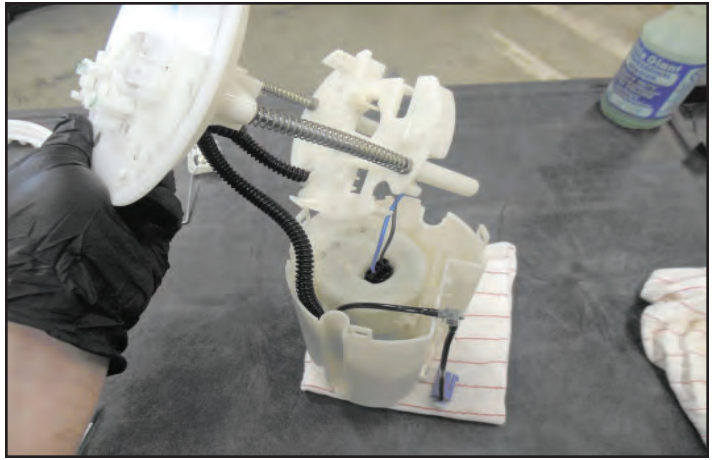

274. Pry up on the two claws as you remove the final inner assembly from the housing.



275. Clean out the inside of the housing. Use some clean rags and Simple Green to make sure all dirty fuel, and debris has been completely removed.

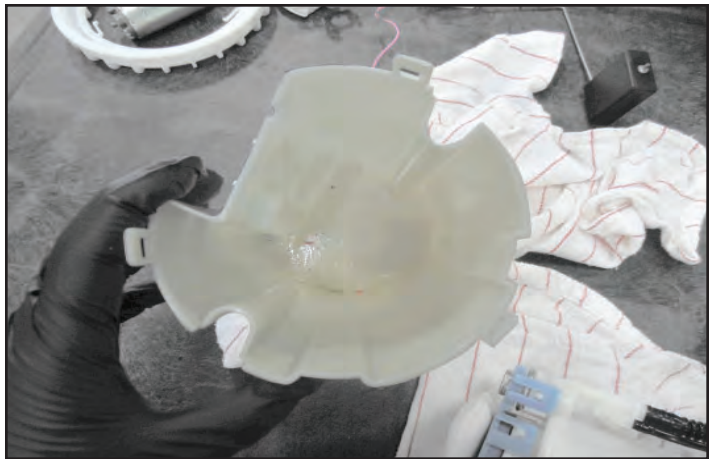

276. Pry the 5 clips of the pump retainer (blue plastic) to remove it. Work them one at a time ensuring that they stay disengaged as you work your way around the retainer.



277. Remove the fuel pump from the assembly, and unplug the electrical connector.



278. Remove the spacer shown from the OEM fuel pump.



279. Remove the OEM O-ring from the bottom of the inner housing (shown with an arrow). This will be discarded. If it is not in the housing then it should be stuck to the pump. Do not gouge the housing when removing the O-ring.

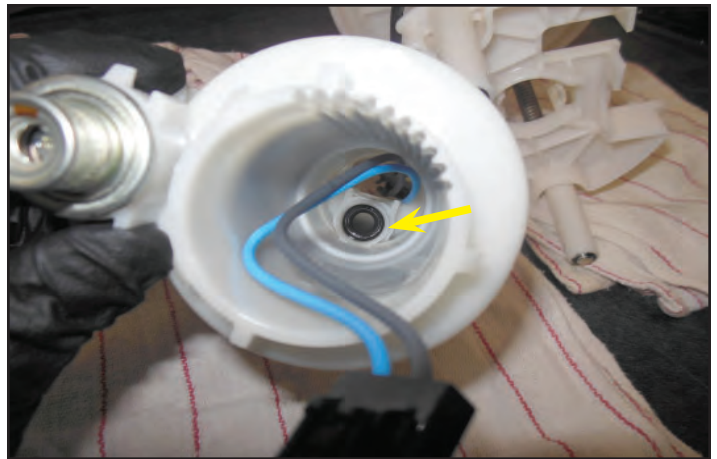

280. Install the spacer with the slots facing down on the newly provided fuel pump. Apply a light coat of Lubriplate grease on the supplied fuel pump discharge O-ring, and insert the pump back into the housing making sure to plug the electrical connection back in. Continue to reassemble the entire pump assembly following the previous steps in reverse.

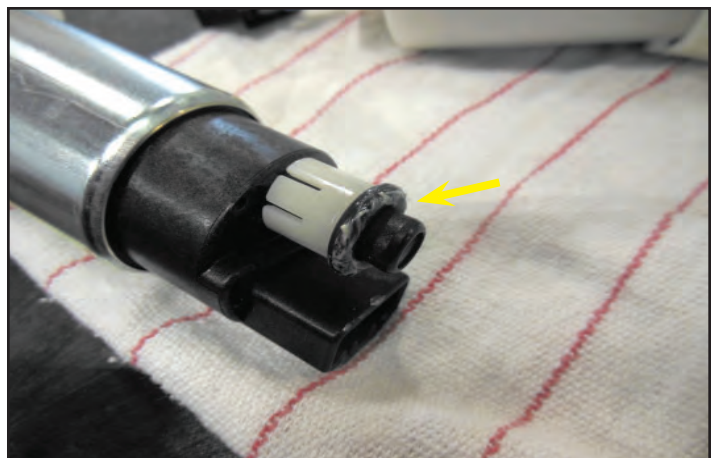

281. Apply Lubriplate grease to the newly provided fuel pump module O-ring and install into the groove. Make sure both sides (top/bottom) of the O-ring have a light coat of grease.

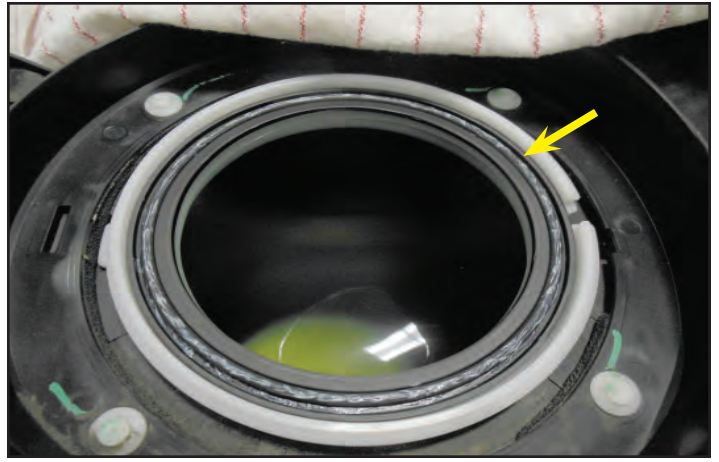

282. Align tab on fuel pump module with the notch in the tank (shown with an arrow) during reinstallation. Hold the module in place while you thread the retainer ring on loosely by hand.

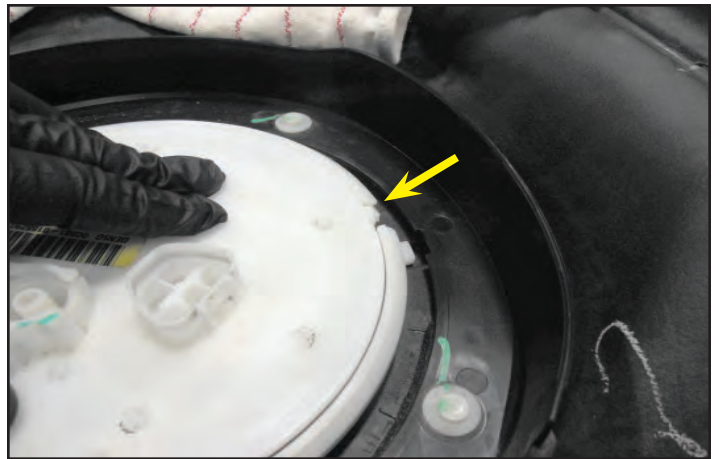

283. Use the lock ring tool to tighten the ring. Make sure the yellow arrow lines up with the yellow mark on the tank.

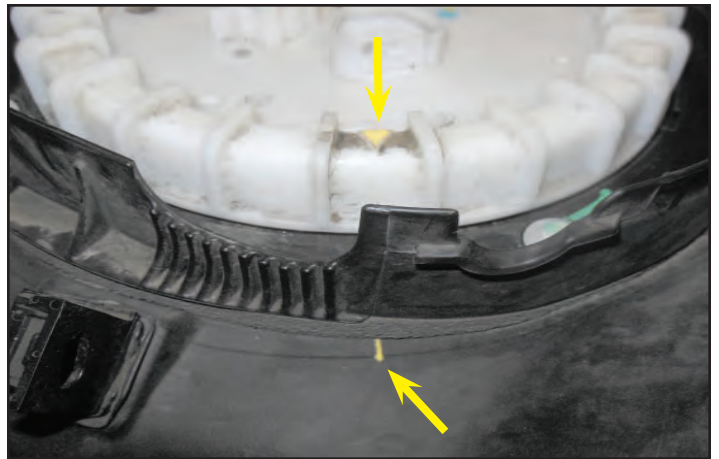

284. Re-Install the two fittings and lock tabs into the fuel pump assembly.



285. Make sure the lines running to the fittings installed in the last step are properly retained on the top of the tank

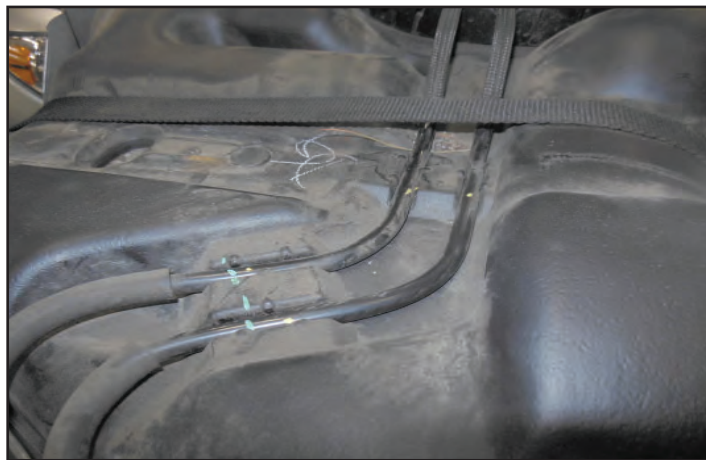

286. Follow the steps at the beginning of this section in reverse to re-install the fuel tank. Ensure that all electrical lines, and fuel lines are re-connected, and properly routed. Make sure that all safety fasteners are fully engaged. Re-install the bands with the OEM pins and bolts. **Torque the bolts holding the bands to 30 ft-lbs.** Reinstall the OEM tank protector with the 2 OEM nuts and bolts if removed earlier.



Section 12: Coolant Fill, and Final Testing

287. Ensure that the drain plug for the radiator is closed. Fill the radiator with a Toyota approved coolant mixture. Re-install the radiator cap. If you saved and reused your coolant, make sure it all gets reused. You may need to add some to the overflow tank to the right of the radiator.



288. Reconnect the negative lead of the battery and tighten the nut with a 10 mm wrench.



Make sure that you have followed step #1 in this manual to load the proper supercharger calibration to your vehicle's ECM.



289. Fill the intercooler reservoir with a Toyota approved coolant mixture until it is full. Have someone else cycle your ignition switch to the accessory mode to trigger the pump on. **Do not start the vehicle!** This will circulate the fluid. Once the reservoir drains turn the pump off, and fill again. **Do not allow the reservoir to run dry.** Repeat until full circulation is achieved with a full reservoir. Fluid level should be just above the top barb. Re-install the reservoir cap.



290. Check the serpentine belt to see that it is aligned properly on all the pulleys. Start the engine and let it idle. Check for fuel, and coolant leaks. Squeeze the inlet and outlet hose on the radiator to remove trapped air from the system. Check the air intake for leaks, and tighten any loose fittings. Shut down the engine, and allow it to cool. At this time you can reinstall the skid plate that was removed in section #2. Also if you have a 2014+ truck reinstall the front grille.

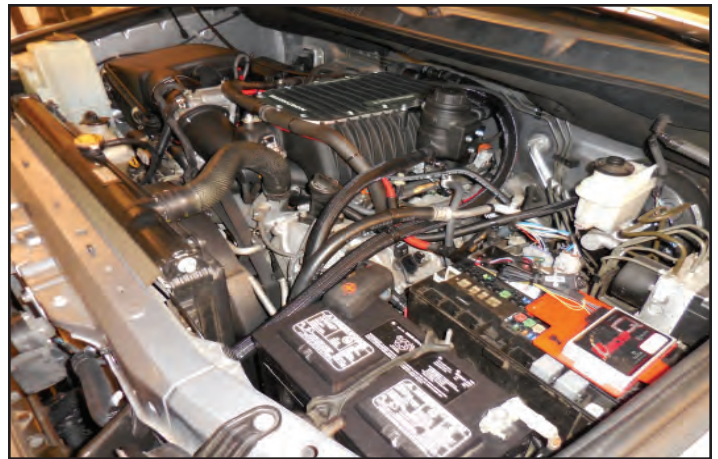

291. Once the engine has cooled down check the level of the radiator reservoir, and the intercooler reservoir. Add coolant if necessary. Test drive the vehicle for the first few miles under normal driving conditions. **Do not perform any wide open throttle runs.** Check for any unusual sounds, vibrations, or engine misfires. The supercharger does have a slight whining noise under boost conditions, which is normal. After the initial test let the engine cool down, and recheck coolant levels.



292. After the initial test drive gradually work the vehicle to wide open throttle runs. Listen for any engine detonation (pinging). If engine detonation is detected let up on the throttle immediately. Most detonation is caused by low octane gasoline still in the tank. Premium 91 octane fuel is required. Enjoy your new supercharger!

If you have questions about your vehicles performance, please check with your installation facility.

After you finish your installation and road test your vehicle, please fill out the warranty registration. This can be found on our website.



Appendix A

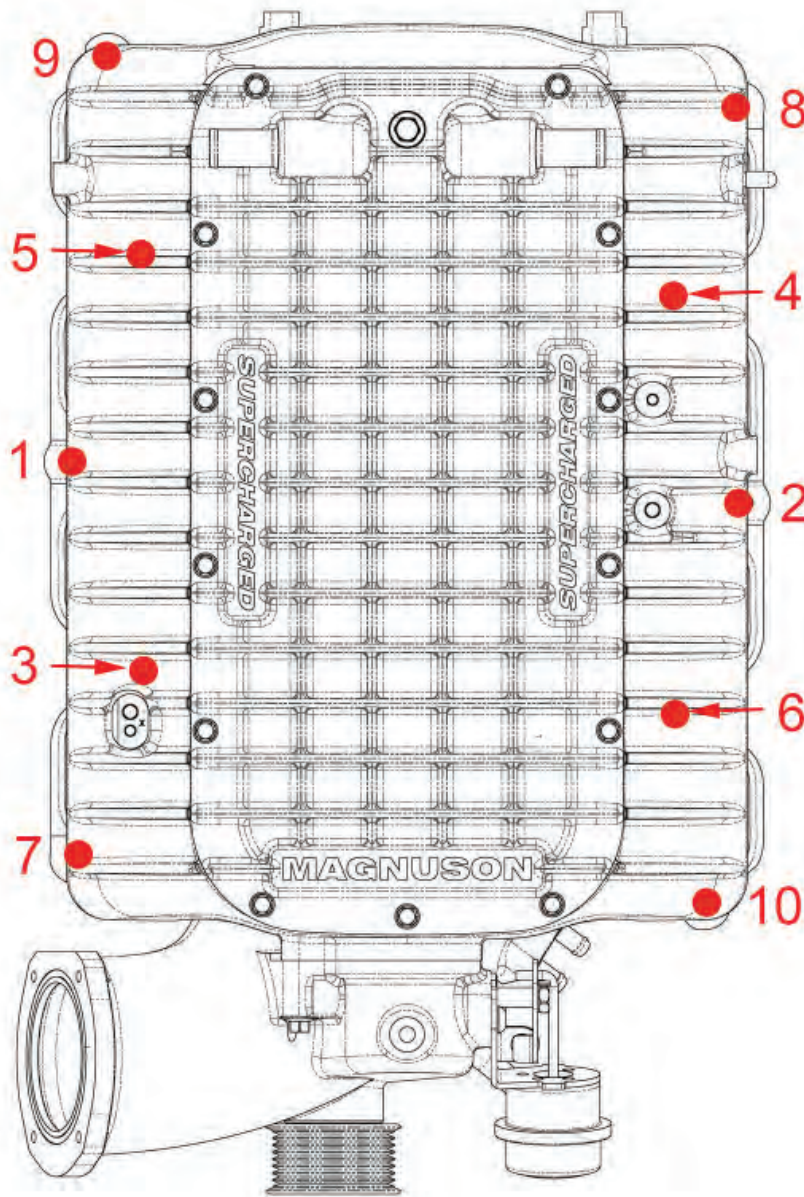

Torque Diagram

Appendix B

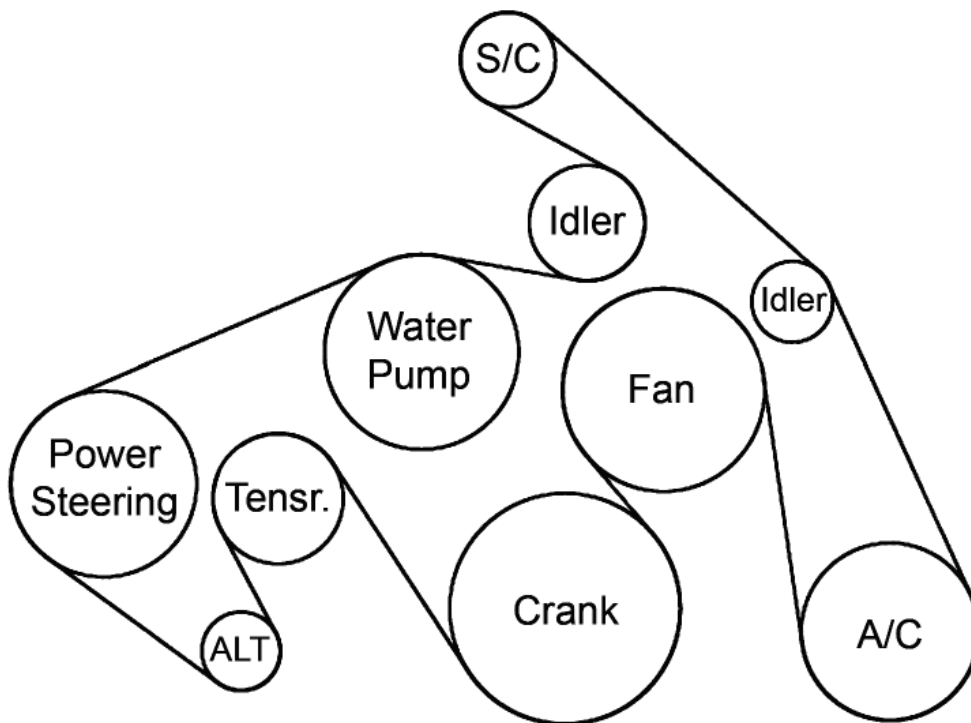

Belt Routing Diagram

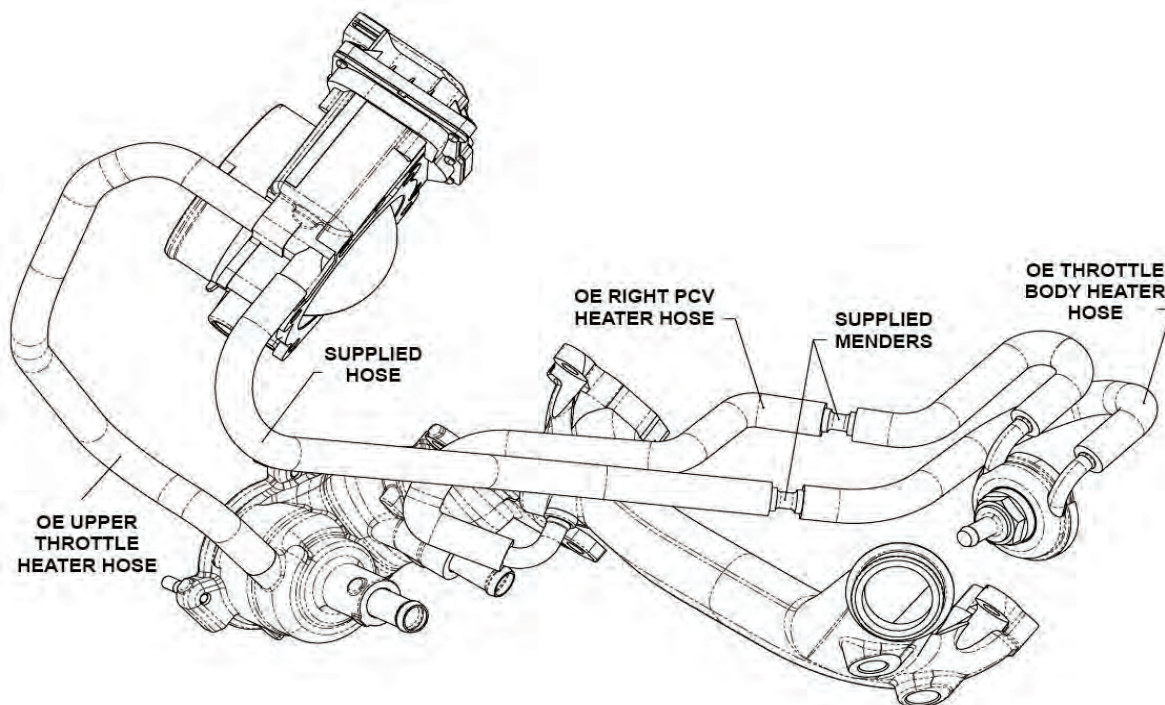

Heated PCV Routing for 2014-2017

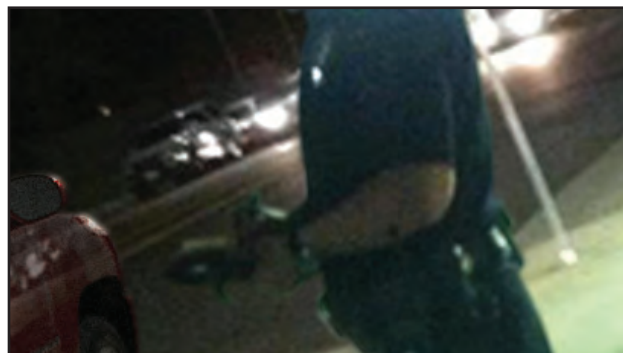

Please enjoy your "Magnuson SuperCharged"
performance responsibly.

Use only premium gasoline fuel, 91 octane or better.

MAGNUSON
SUPERCHARGERS

MAGNUSON

SUPERCHARGERS

Instructions for: Toyota 5.7L Coupler Replacement



*** PREMIUM GASOLINE FUEL REQUIRED ***



ATTENTION!
Your **MAGNUSON SUPERCHARGER** kit
is sensitive to corrosion!
Use only the vehicle manufacturer
recommended coolant for your engine in
the intercooler system as well.

Magnuson Products LLC
1990 Knoll Drive, Bldg A, Ventura, CA 93003
(805) 642-8833 phone
magnusonsuperchargers.com

Tools Required

Metric wrench set

Metric 3/8" and 1/2" drive metric socket set (standard & deep)

3/8" and 1/2" drive ft-lbs and in-lbs torque wrenches

Metric Allen socket set 3/8 drive

Metric Allen wrenches

Phillips and flat head screwdrivers

Serpentine belt tool

Engine hoist and supercharger lift bracket

Small crows foot pry bar

Telescoping magnet

Safety glasses

Any reference to the left or right side of the vehicle is given from the driver's seat perspective.

1. We recommend you read this manual completely before starting this job to familiarize yourself with all the tools needed, and the work involved. Ensure that the vehicle has had time to cool down before proceeding with the coupler replacement.



2. For visual clarity here is a photo of the stock engine out of the vehicle to show the location of the belt tensioner. The yellow arrow location is where you will attach a socket with a breaker bar in order to remove your serpentine belt.



3. Rotate the belt tensioner clockwise with a socket, and breaker bar to release the tension.

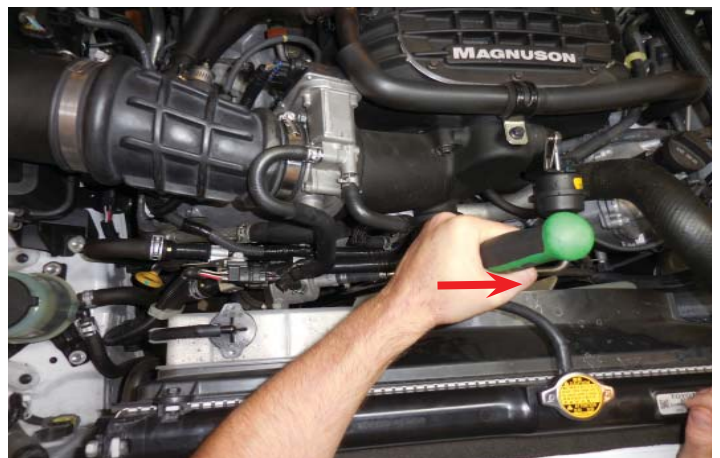

4. Remove the belt at the supercharger pulley. You may need an assistant to remove the belt while you rotate the tensioner. Check the condition of the serpentine belt and replace if necessary. (Dayco #5081125)



5. Remove the two hose clamps holding the air duct in place shown with arrows in this photo.



6. Disconnect the air duct from the throttle body, and the air box. The air duct will remain in this position with the other hoses connected.



7. Remove the four bolts holding the throttle body in place.

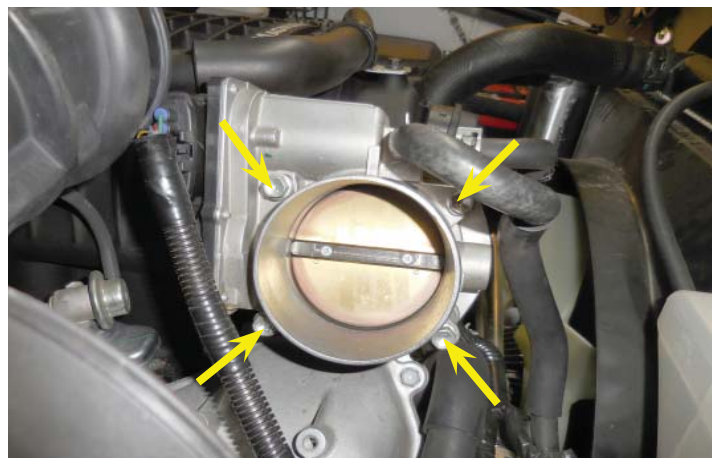

8. Move the throttle body aside as shown with all the hoses connected. Check the O-ring at the mounting surface for damage and replace as necessary.



9. Loosen the four bolts (2 on each side) holding the fuel rails in place. One of these bolt locations is shown with a red arrow in this image.

Note: The bolts need to be deep enough so that they prevent the spacers from lifting out of the grooves, but loose enough so the rails can pivot side to side.



10. Remove the bolt securing the vent hose at the front of the supercharger.



11. Remove the two bolts holding the reservoir bracket shown with arrows if equipped..



12. Remove the lower bolt holding the reservoir bracket in place.

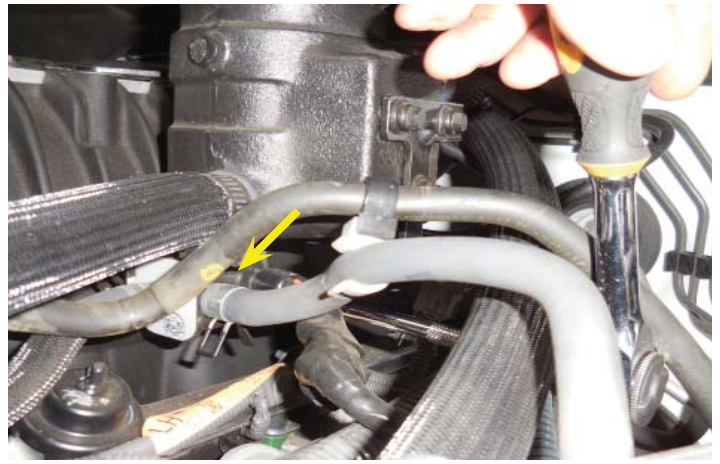

13. Squeeze the ears on the hose clamp shown with the arrow, and slide it upwards on the hose.

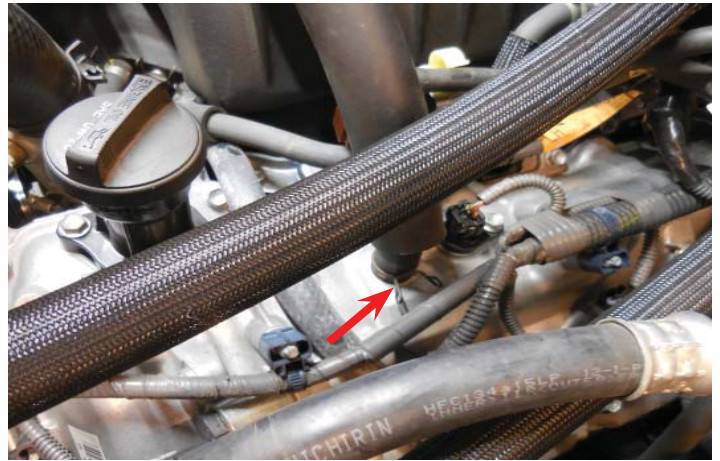

14. Disconnect the hose from the last step.

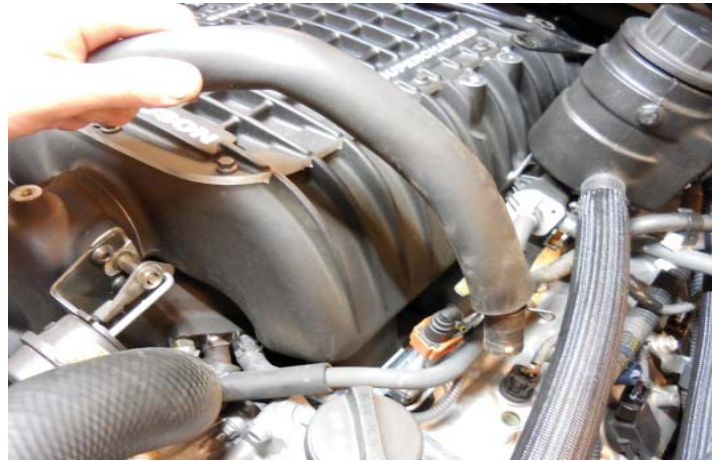

15. Move the hose assembly to the right of the supercharger as shown.



16. Disconnect the hose going to the PCV valve. This is the forward most connection at this location shown with a red arrow.



17. Here you can see the PCV hose from the last step is removed. Remove the brake booster hose (shown with the yellow arrow) and the VSV hose (shown with the blue arrow).

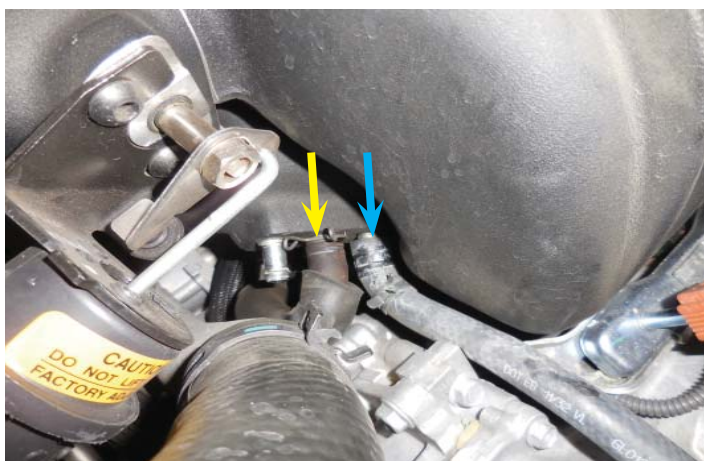

18. Slide the fuel hose shown off of the clamp to gain more clearance.

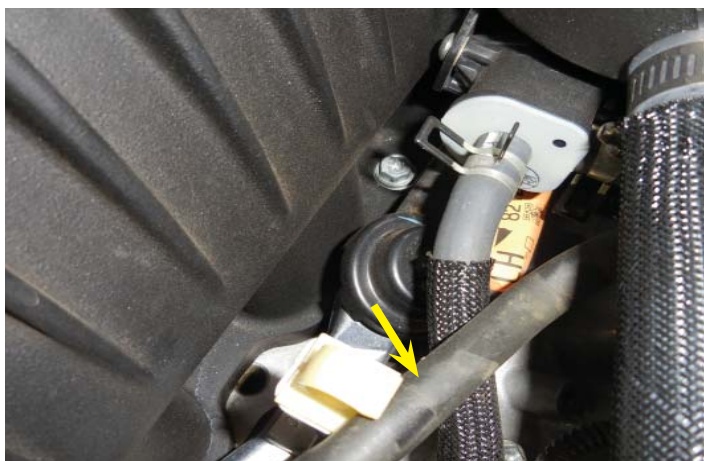

19. Remove the 10 bolts holding the super-charger to the manifold. The locations of these bolts are shown in the Torque Diagram at the back of this manual.



20. Remove the bolt holding the ventilation hose assembly shown with an arrow.



21. Install a lift bracket across two bolts shown to extract the supercharger. If you are not able to acquire a lift bracket, and engine hoist, you will need some help lifting the supercharger up, and it will have to be supported by some wood. **Be extremely careful not to drop anything down into the intake ports. Also do not damage the sealing surfaces of the intake ports.**



22. Attach an engine hoist to the supercharger and slightly lift it as shown. **Do not attempt to completely remove the supercharger since the coolant lines are still connected.**



23. Remove the four bolts shown with arrows on the nose cover.

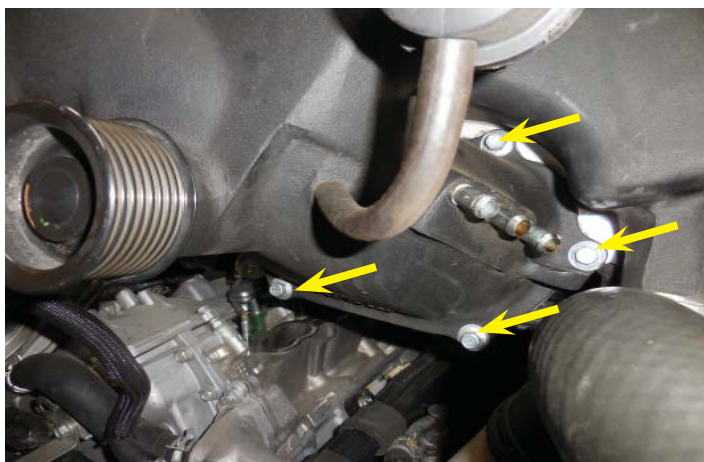

24. Remove the bolt shown with the arrow on the underside of the nose cover.



25. Remove the last bolts shown with the arrow securing the nose cover.



26. Once all 6 bolts have been removed from the nose cover you can use a plastic mallet to tap the nose cover loose. Hold the nose cover while doing this to catch it when it finally does come loose.



27. Attain the following "crows foot" pry bar. The dimensions are given in the photo.



28. If the coupler remains on the housing side of the supercharger place the tip of the crows foot pry bar behind the coupler and lever it outwards.

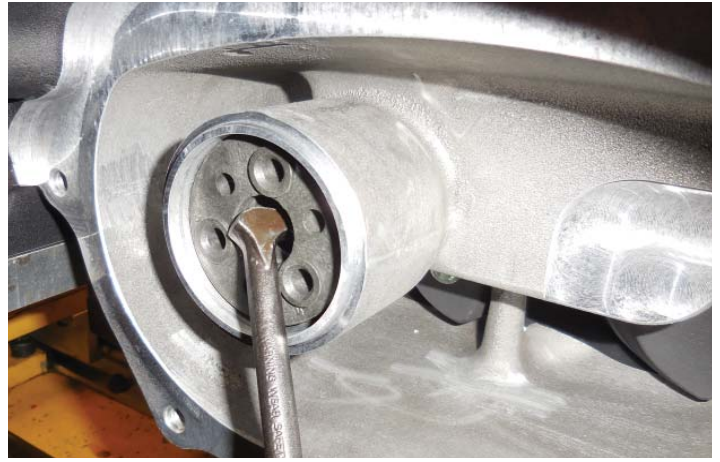

29. You may have to work your way around the inside of the coupler to avoid binding.



30. Here you can see the hub surface after the coupler has been removed. Clean this area with a dry rag prior to assembly.



31. If the coupler is attached to the hub on the nose cover you will have to first pry it out with a small prybar or screwdriver.



32. Once you have pried the coupler out far enough you will be able to use the crows foot pry bar to remove the coupler completely. Check both O-rings on the nose cover (shown with red arrows) to ensure that they aren't damaged. Replace if necessary. Also check and clean all sealing surfaces on the supercharger prior to reinstalling.



33. Apply a light coat of lithium grease to all 6 small holes in the coupler using a cotton swab prior to installation. When installing on the hub pins make sure to do so on the larger chamfered side (shown with red arrows).

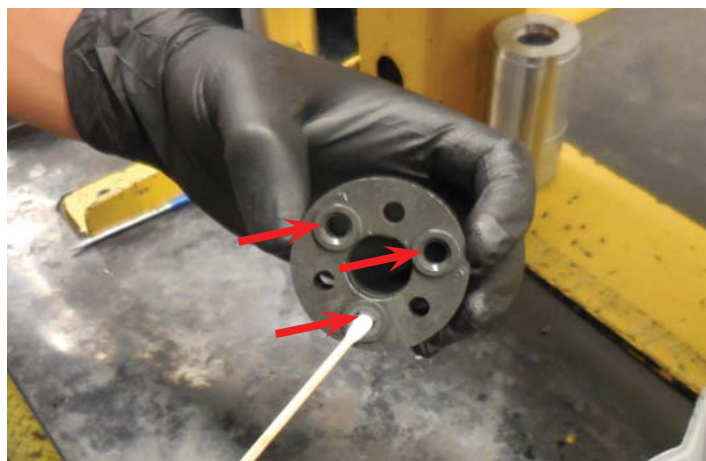

34. Press the coupler onto the nose cover hub by hand. **Do not hammer the coupler on as it could damage the bearings.** The remaining three holes should have the large chamfers facing outwards as shown with the arrows, and the pins should be protruding.

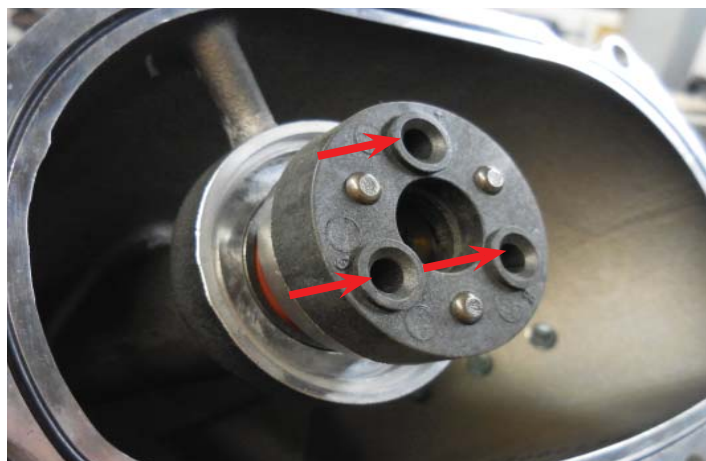

35. Ensure that the coupler is flush against the hub. Check both O-rings on the nose cover to ensure that they aren't damaged. Replace if necessary. Also check and clean all sealing surfaces on the supercharger prior to reinstalling.



36. Reinstall the nose cover to the blower. You will have to line up the 3 open holes on the coupler with the hub pins on the housing side as you push the nose cover on. Make sure the nose cover presses on completely prior to installing the 6 mounting bolts. The OE M8x45mm bolt goes in the blue arrow location. The M8x25mm bolts are at the red arrow locations. If you have a notch in your nose cover housing near the green arrow location a M8x25mm bolt with an Allen head will go there otherwise this bolt will be the same as the red bolt locations. **Torque all 6 bolts to 18 ft-lbs using a criss-cross pattern.**

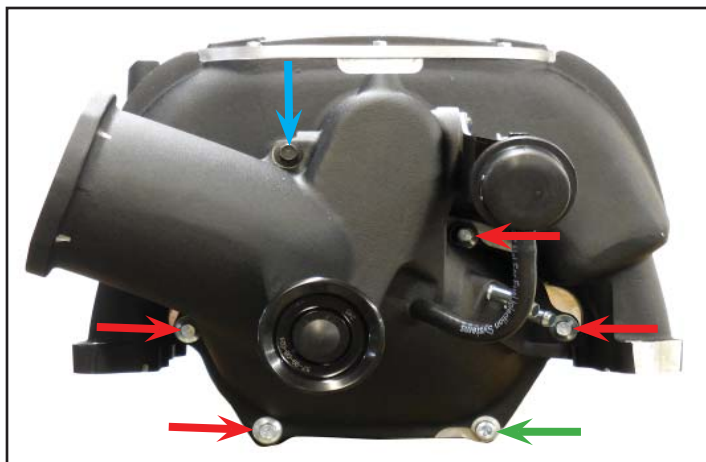

37. Check to make sure there is nothing in the way of the supercharger before lowering it. Lower the supercharger back into position over the intake ports



38. Install the OE bolts and nuts to secure the supercharger in place. Use a telescoping magnet (shown with a yellow arrow) to drop the bolts in place.



39. **Follow the torque sequence given in the diagram at the back of this manual. Torque the 10 manifold bolts to 15 ft-lbs. Also at this time torque the 4 fuel rail bolts to 15 ft-lbs.**

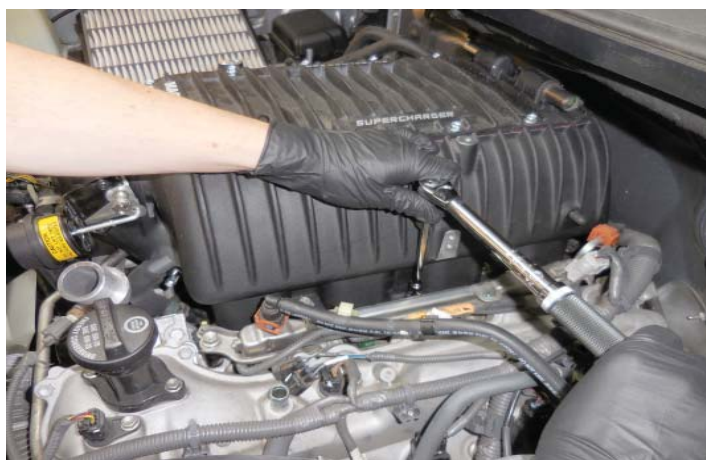

40. Slide the fuel hose back into the retainer clip shown.



41. Install hoses back into their original locations. Connect the PCV hose to the forward air tube (red arrow), the brake booster to the middle air tube (yellow arrow), and the VSV hose to the back air tube (blue arrow). Secure these hoses with their original clamps.



42. Connect the vent hose back to the valve cover (shown with a red arrow) and secure with OE clamp.



43. Install the lower mounting bolt for the reservoir bracket. Torque this bolt to 108 in-lbs.



44. Install the two upper mounting bolts for the reservoir bracket if equipped. Torque the M6 bolt to 108 in-lbs, and the M8 bolt to 18 ft-lbs.

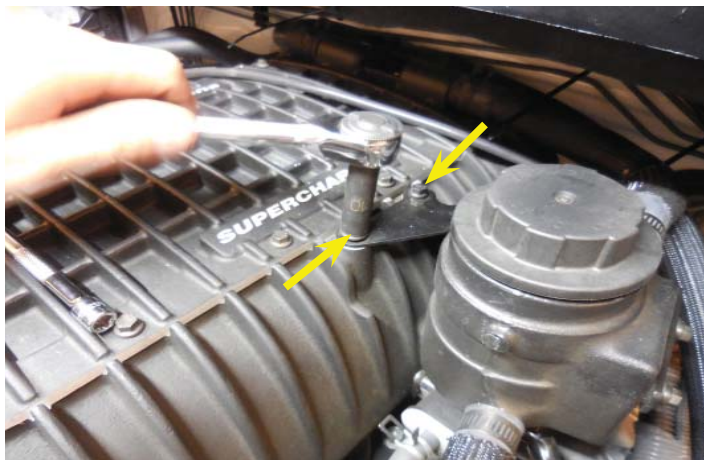

45. Install the bolt holding the ventilation hose at the location shown with the arrow. Torque this bolt to 108 in-lbs.



46. Install the bolt holding the ventilation hose at the nose cover (shown with the arrow). Torque this bolt to 18 ft-lbs.



47. **Make sure the 4 bolts holding the fuel rails are tight if you haven't already done so. Torque these bolts to 15 ft-lbs.**



48. Mount the throttle body and secure it in place with the 4 OE bolts. Torque to 108 in-lbs.

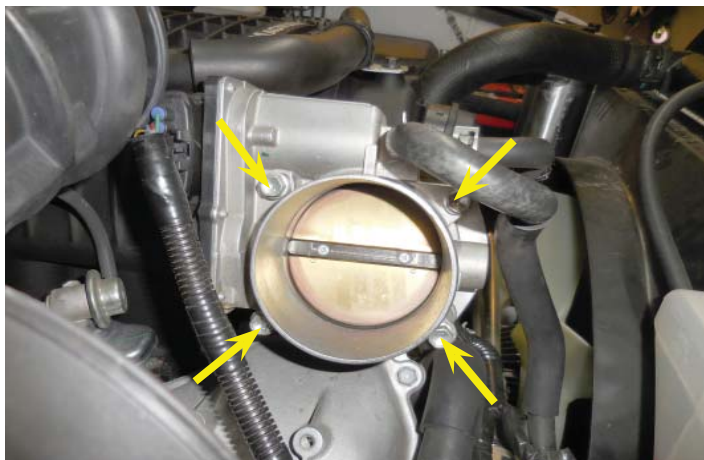

49. Install the air duct and tighten the two hose clamps shown with arrows.



50. Release the tension on the belt tensioner and place the belt back in its original location. There is a belt routing diagram at the back of this manual.



51. You may need some help to locate the belt on the supercharger pulley while you have the tensioner released.



52. Check all your connections, and fluid levels prior to starting the engine. Also check for any tools that may have been left in the engine bay. Start the engine and check for any leaks. Listen for any unusual noises while the engine is idling. You have successfully replaced your supercharger coupler.

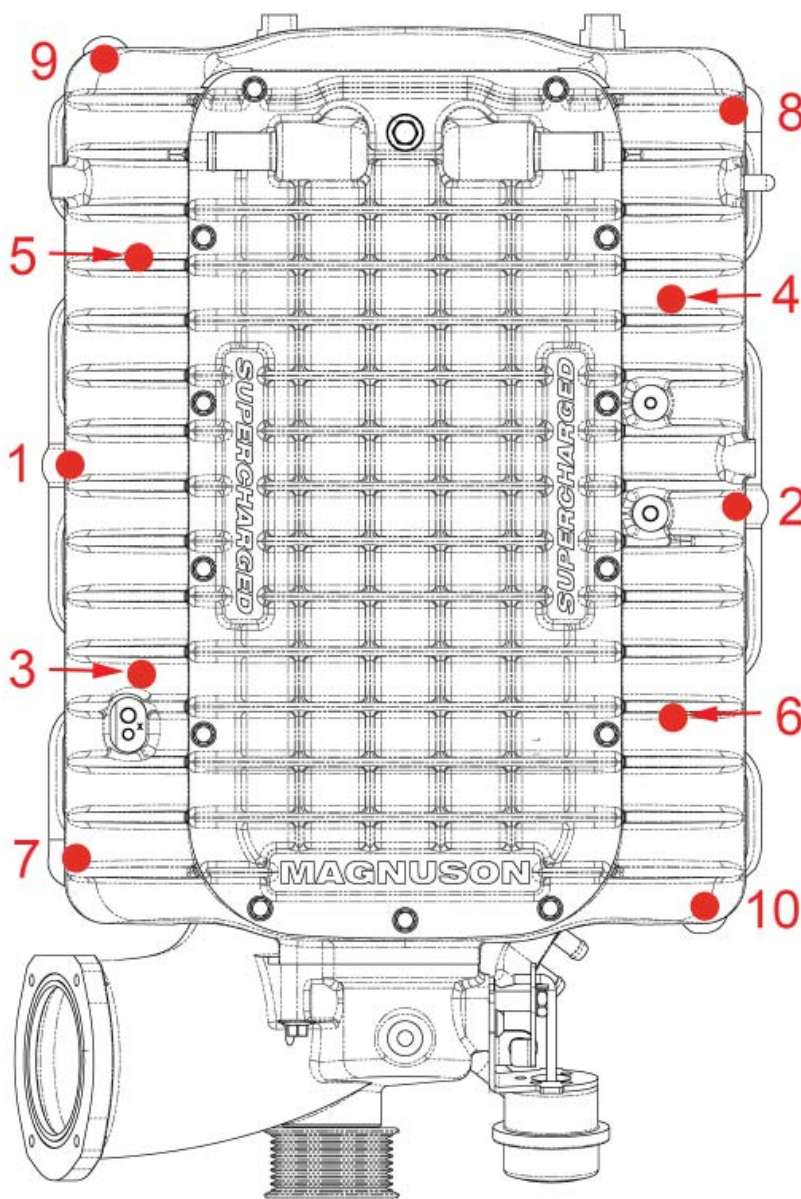

5.7L Toyota Torque Diagram

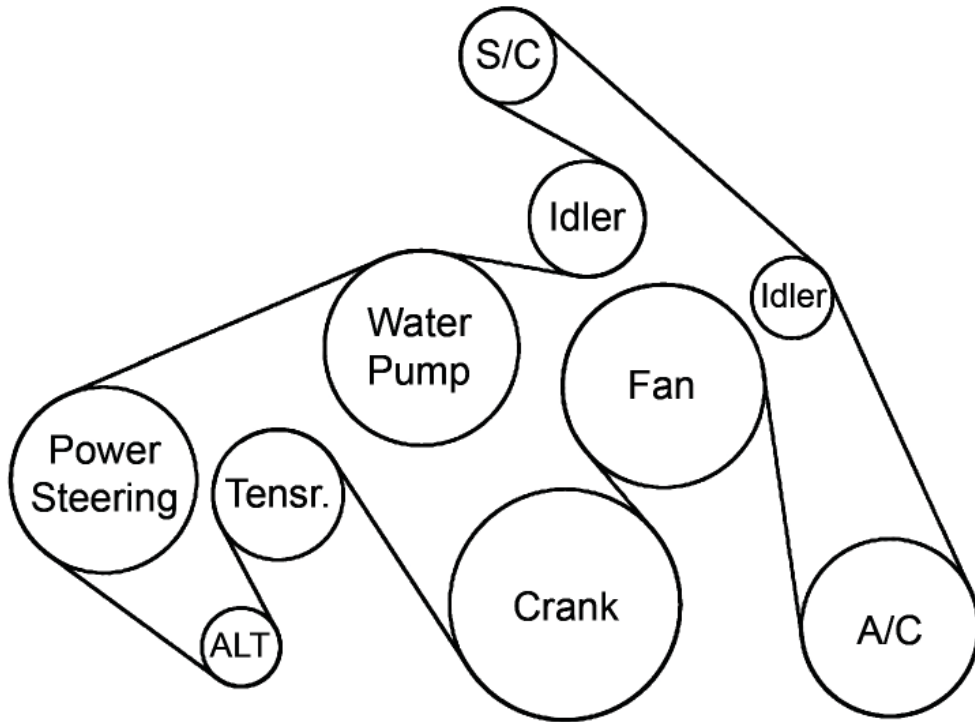

5.7L Toyota Supercharger Belt Routing Diagram

Use only premium gasoline fuel, 91 octane or better.

MAGNUSON
SUPERCHARGERS

MAGNUSON

SUPERCHARGERS



VF Tuner

Flash Tool Instructions

NOTES

***It is the responsibility of the customers/installer to make sure the vehicle is on the latest stock calibration from Toyota.**

A laptop computer running Windows 7, 8 or 10 with an Internet connection is required.

Go to MagnusonSuperchargers.com

1. Identify the VF Tuner flash tool that you have. The two types this manual deals with are shown here. Each tool has its own software link that will be described in the next step.



2. Go to <https://www.magnusonsuperchargers.com/> and click on the "Support" tab at the top of the page. Please download the correct link for the tool you have in the kit.

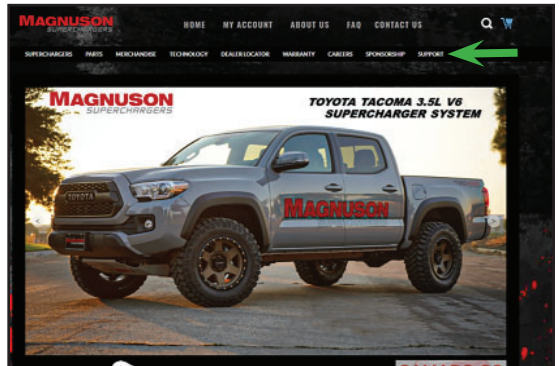

3. Once you have downloaded the correct version of software for the device you have you will Click on "Run".

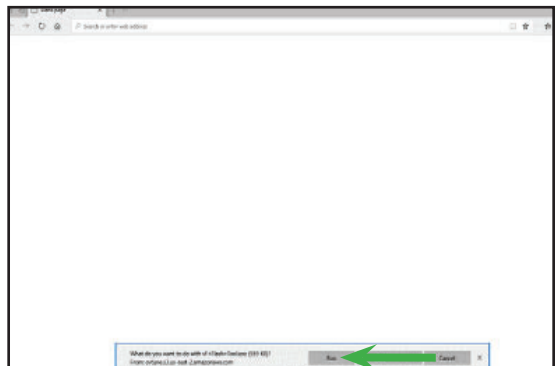

4. If you get a “Windows protected your PC” message, click on more info.

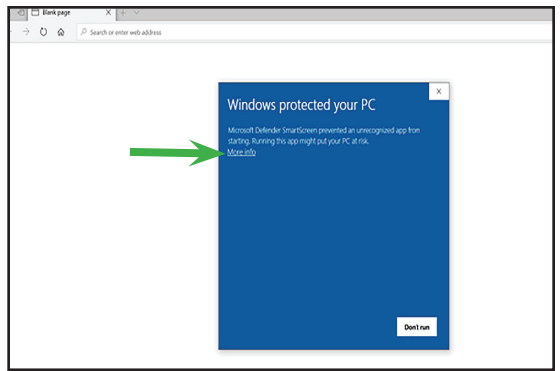

5. Click on “Run Anyway”.

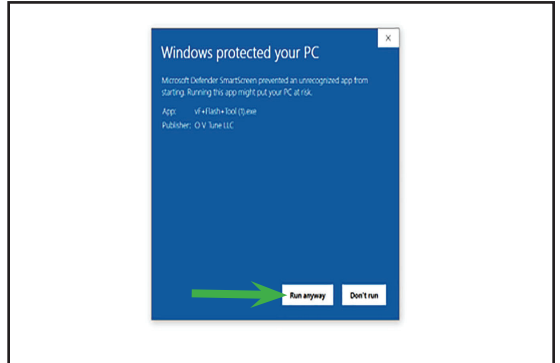

6. Select “I accept the agreement” then click “Next”.

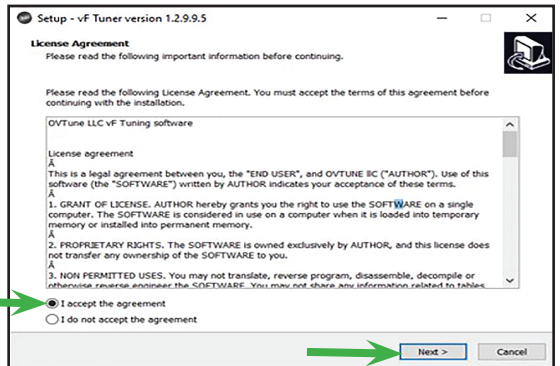

7. Click on “Next”.

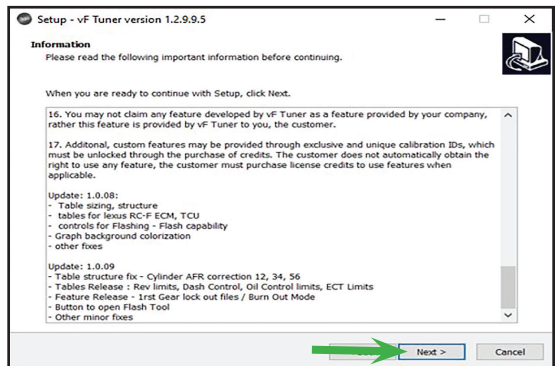

8. Click on "Next".

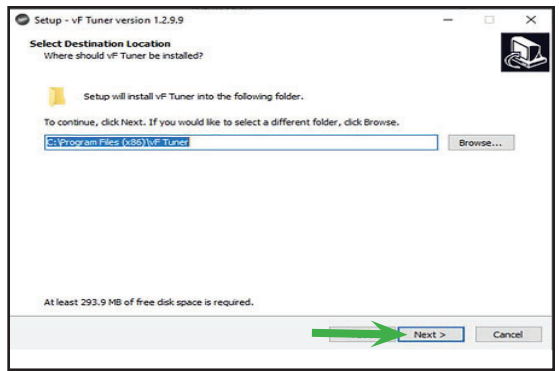

9. Select "Create a desktop shortcut". Click on "Next".

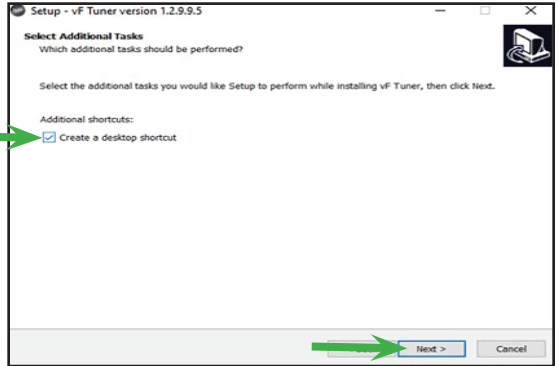

10. Click on "Finish".

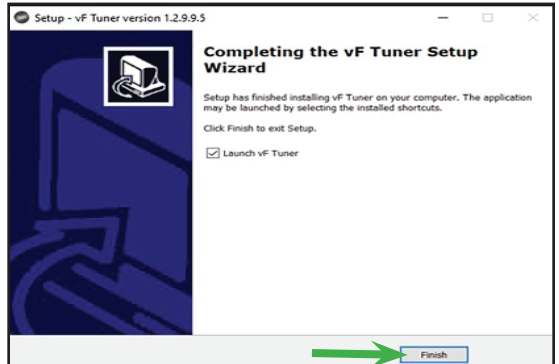

11. The following instructions starting on the next page will have specific steps for the device you have. Before each step it will indicate if the step is for the "WiFlash device" or "Legacy Flash device". Steps without any device identifier need to be followed for either device.

Driver install:

WiFiFlash device ONLY

12. Find the installation folder of your VF Tuner. Look for the “Driver” installer and double click on it to run the driver installer.

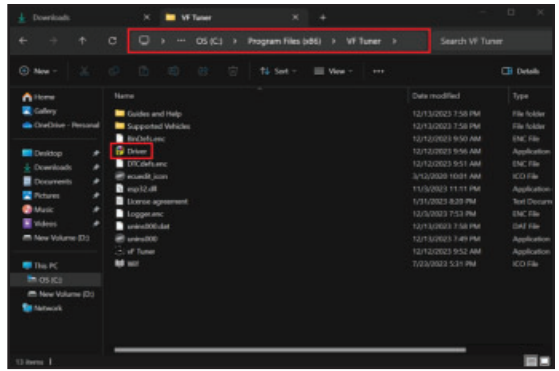

WiFiFlash device ONLY

13. Click yes.

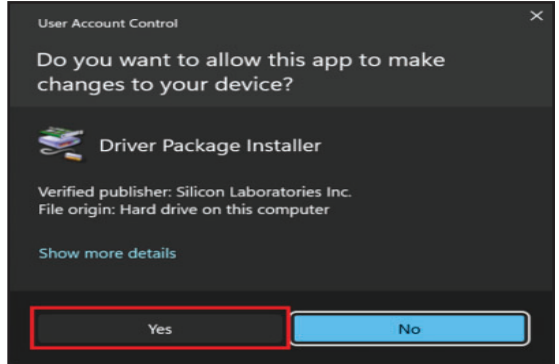

WiFiFlash device ONLY

14. Click “Next” and follow the steps.

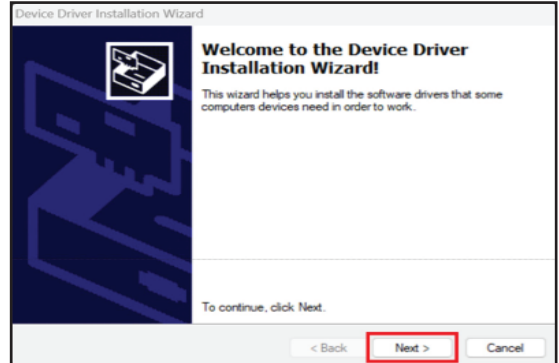

WiFiFlash device ONLY

15. Click “Finish”



Legacy flash device ONLY

20. Click "Next".

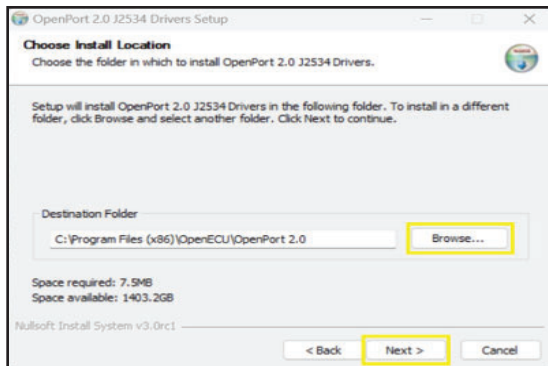

Legacy flash device ONLY

21. Click "install".

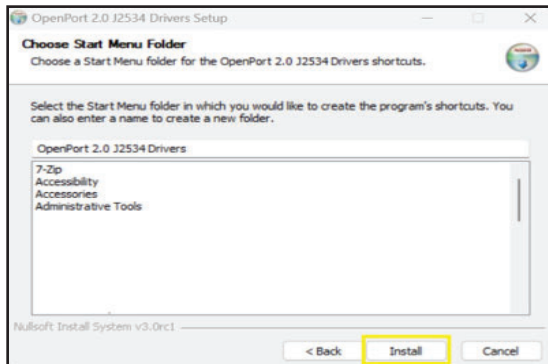

Legacy flash device ONLY

22. Let the install finish and then click "Next".

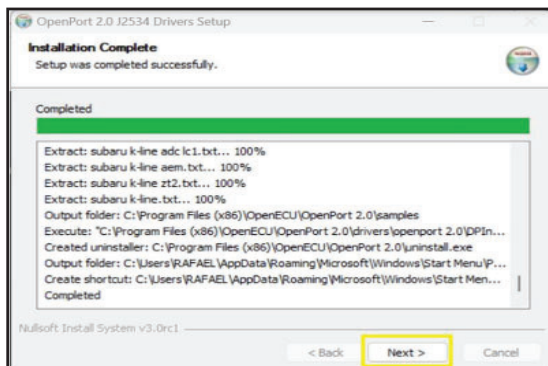

Legacy flash device ONLY

23. Click "Finish".

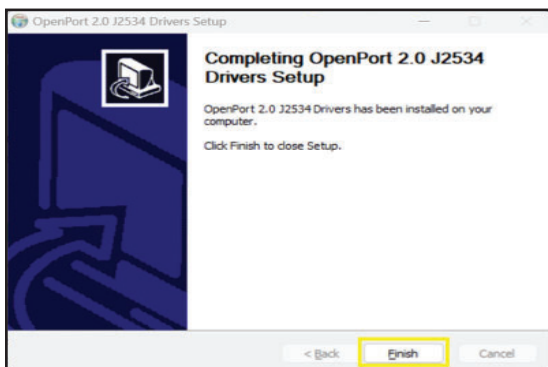

24. Open the software by double clicking on the software shortcut icon “vF Tuner” on your computer desktop.

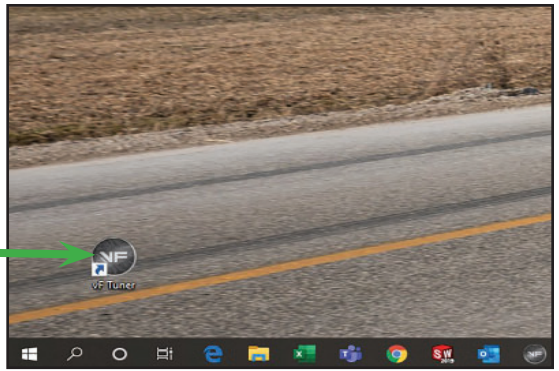

25. An error window will appear. Please select the code and right click copy. This code will be pasted into a form.

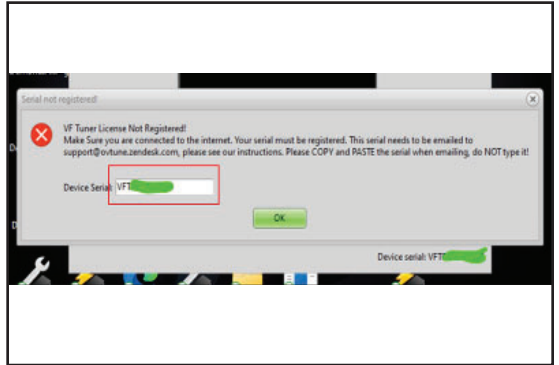

***It is the responsibility of the customers/installer to make sure the vehicle is on the latest stock calibration from Toyota.**

A laptop computer running Windows 7, 8 or 10 with an Internet connection is required.

Go to MagnusonSuperchargers.com

26a. **For Tacoma:**
 Under Superchargers
 → Toyota → Tacoma
 → Toyota Tacoma
 2GR-FKS 3.5L V6
 Superchargers System
 → Manuals, Documents
 and Calibration. Click on
**“Toyota Tacoma 3.5L
 Calibration File Form 1”**.

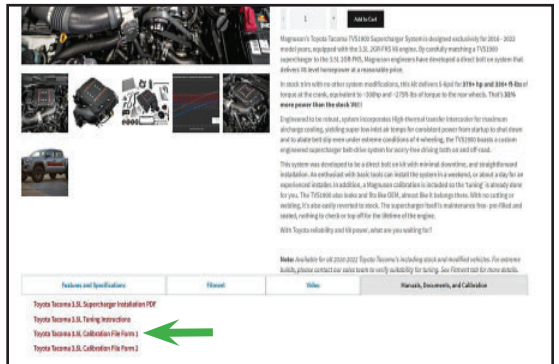

26b. **For Tundra:**

Under Superchargers
→ Toyota → Tundra →
2019 Toyota Tundra
3UR-FE 5.7L V8
Superchargers System
→ Manuals, Documents
and Calibration. Click on
“**Toyota Tundra 2019+
Calibration File Form 1**”.

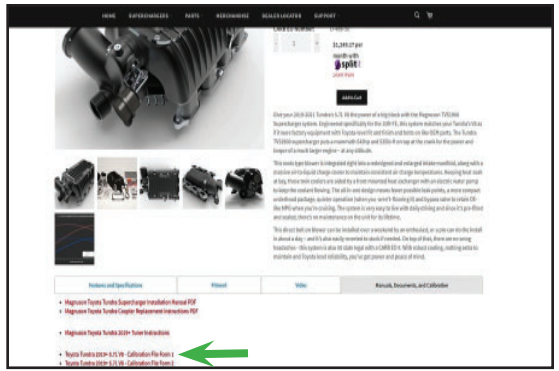

26c. **For 4Runner:**

Under Superchargers
→ Toyota → 4Runner →
TVS1320 4Runner 4.0L
Supercharger System
→ Manuals, Documents
and Calibration. Click on
“**Toyota 4Runner 4.0L
Calibration File Form 1**”.

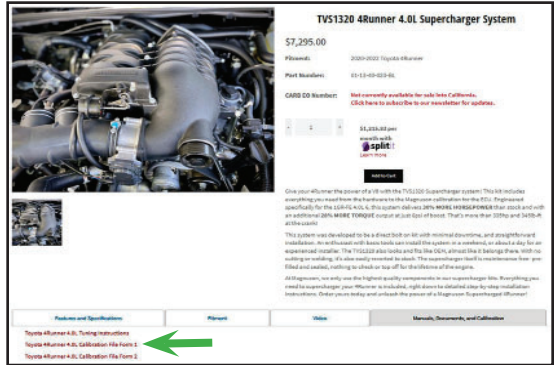

27. Fill out the Calibration File Form 1. Please use accurate information in order to get a faster response. Tool will be licensed within 24 hours (Monday-Friday excluding holidays). Paste the code in the box that asks for the tool serial number.

NOTE: We will email you back when the tool is registered.

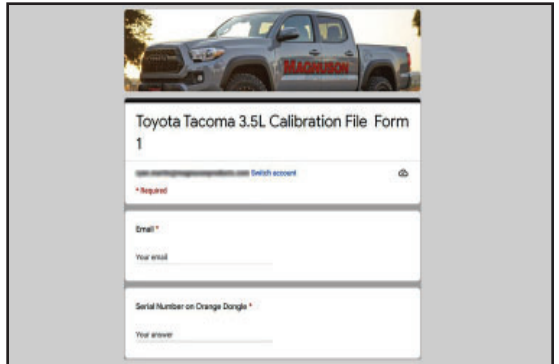

28. **Connect your vehicle's battery to a battery charger to ensure that you have at least 12V at all times while following these instructions.**



29. Gather the supplied VF Tuner flash device.



Identify the ECU

30. The following steps require you to connect your vehicle to a laptop through the OBDII Port using the flash device. You **MUST** also have internet connection on your laptop.



Legacy flash device ONLY

31. If you have the Legacy device, click on the “File” menu, and select “Flash ECU – Legacy Flasher”.

(Continue on Next Page)

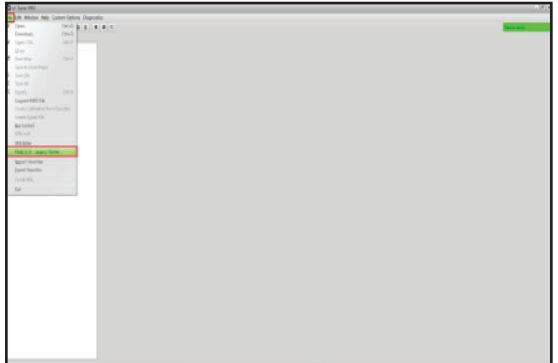

Legacy flash device ONLY

32. Turn on your car's ignition. Make sure that:
 - a. All your electrical loads (like air conditioning, headlights, indoor lights, radio, etc) are completely off (or as much as you can turn off)
 - b. Your ignition must be on, but your engine is OFF/NOT idling.
 - c. Place your car keys as near as you can to the start/stop button.
 - d. Make sure you have at least 12V of power from your battery and can maintain that voltage for the duration of the flash.
 - e. Check the connections of your WiFlash/Legacy device to the laptop and to the OBD2 port.
 - f. Do not move the laptop or the WiFlash/Legacy device to prevent connection loss.
 - g. Wait 15-20 seconds before proceeding to the next step.

Legacy flash device ONLY

33. Click on "Prepare ECM" the ID number is your calibration ID. Do not license the vehicle at this point yet. **Calibration ID should look something like ex: 8966304B3100**

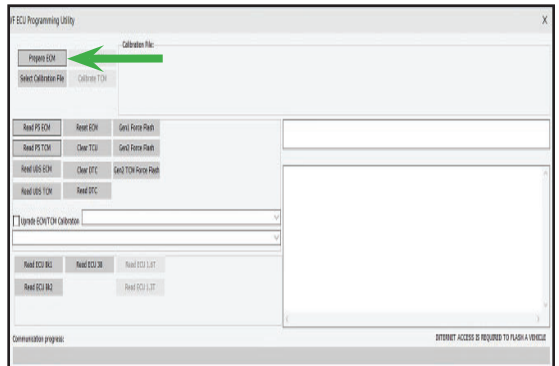

WiFlash device ONLY

34. Click on the WiFlash icon.

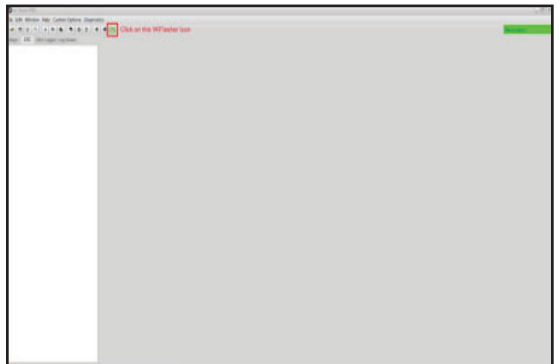

WiFlash device ONLY

35. The WiFlash Vehicle Programming Utility window will pop up. Make sure that the “Log Connection to File” is **NOT checked**. Verify that there is a text on the “Device” dropdown. > if the dropdown is empty, then the WiFlash device cannot be detected.

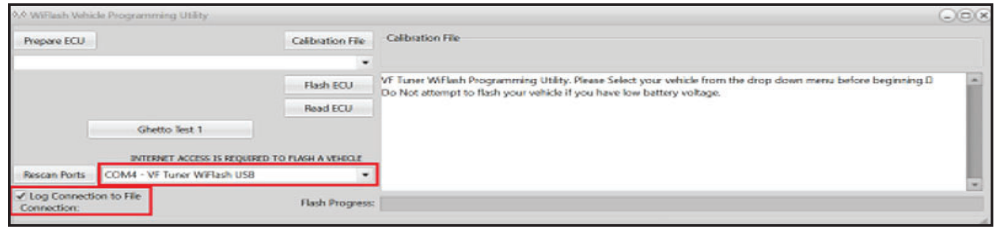

WiFlash device ONLY

36. Click on the dropdown menu and select the Toyota Gen 2 1.5/2.0MB.

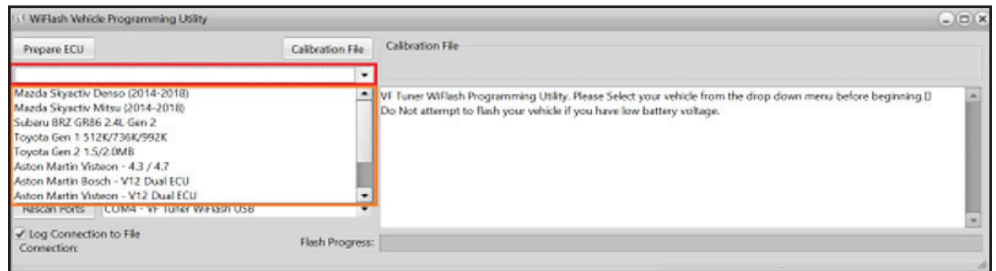

WiFlash device ONLY

37. Turn on your car’s ignition. Make sure that:

- All your electrical loads (like air conditioning, headlights, indoor lights, radio, etc) are completely off (or as much as you can turn off)
- Your ignition must be on, but your engine is OFF/NOT idling.
- Place your car keys as near as you can to the start/stop button.
- Make sure you have at least 12V of power from your battery and can maintain that voltage for the duration of the flash.
- Check the connections of your WiFlash/Legacy device to the laptop and to the OBD2 port.
- Do not move the laptop or the WiFlash/Legacy device to prevent connection loss.
- Wait 15-20 seconds before proceeding to the next step.

WiFlash device ONLY

38. Click the “Prepare ECU” button. A small window will pop-up, please click “Ok”.

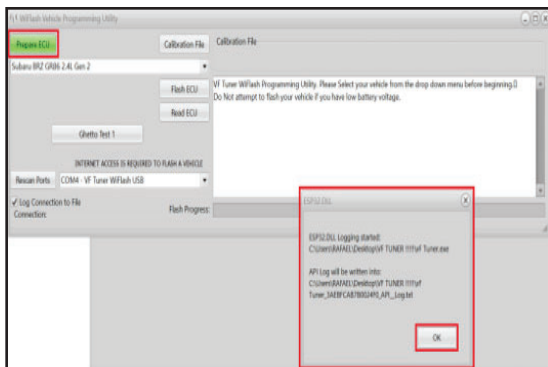

WiFlash device ONLY

39. Locate your ID number that is number required for form2. Example: 8966304C2100.

Both Devices need to follow the instructions below.

Go to back to MagnusonSuperchargers.com

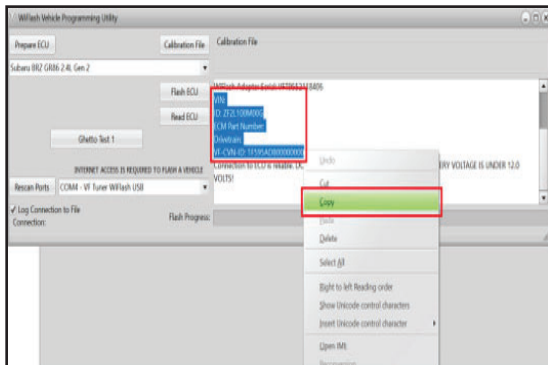

40a. **For Tacoma:**

Under Superchargers
→ Toyota → Tacoma
→ Toyota Tacoma
2GR-FKS 3.5L V6
Superchargers System
→ Manuals, Documents
and Calibration. Click on
“**Toyota Tacoma 3.5L
Calibration File Form 2**”.

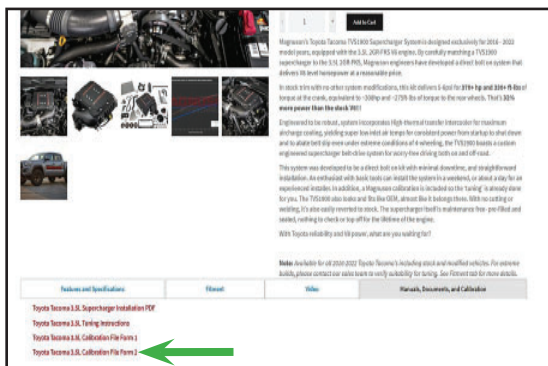

40b. **For Tundra:**

Under Superchargers
→ Toyota → Tundra →
2019 Toyota Tundra
3UR-FE 5.7L V8
Superchargers System
→ Manuals, Documents
and Calibration. Click on
“**Toyota Tundra 2019+
Calibration File Form 2**”.

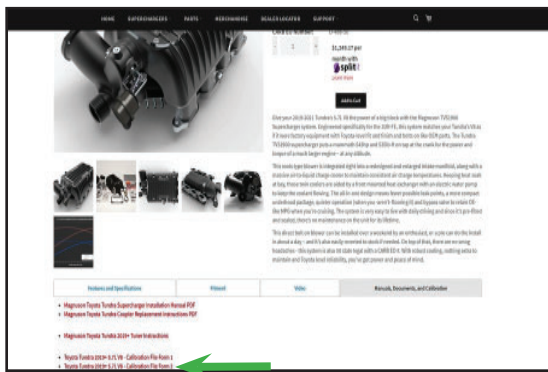

40c. For 4Runner:

Under Superchargers
→ Toyota → 4Runner →
TVS1320 4Runner 4.0L
Supercharger System
→ Manuals, Documents
and Calibration. Click on
“Toyota 4Runner 4.0L
Calibration File Form 2”.

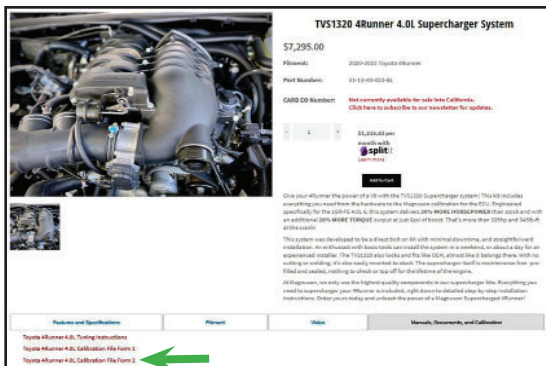

41. Fill out the Calibration
File Form 2. Please use
accurate information
in order to get a faster
response.*Magnuson
Superchargers will
send back a calibration
file within 24 hours
(Monday-Friday excluding
holidays).



Magnuson Superchargers will send you an email that contains the calibration file. Please save the file in a location you can find.

Legacy flash device ONLY

42. If you have the Legacy
device, click on the “File”
menu, and select “Flash
ECU – Legacy Flasher”.

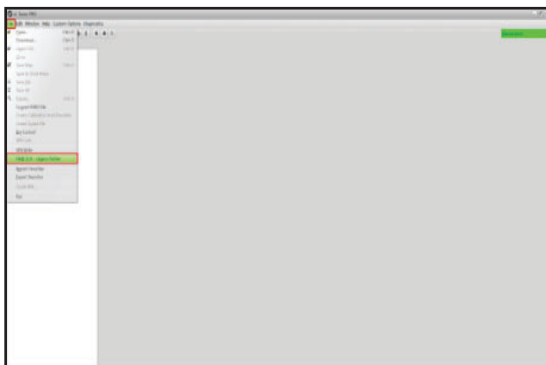

Legacy flash device ONLY

43. Turn on your car's ignition. Make sure that:

- All your electrical loads (like air conditioning, headlights, indoor lights, radio, etc) are completely off (or as much as you can turn off)
- Your ignition must be on, but your engine is OFF/NOT idling.
- Place your car keys as near as you can to the start/stop button.
- Make sure you have at least 12V of power from your battery and can maintain that voltage for the duration of the flash.
- Check the connections of your WiFlash/Legacy device to the laptop and to the OBD2 port.
- Do not move the laptop or the WiFlash/Legacy device to prevent connection loss.
- Wait 15-20 seconds before proceeding to the next step.

Legacy flash device ONLY

44. **Make sure you have a battery charger connected.** Click on “Prepare ECM” Follow on screen prompts.

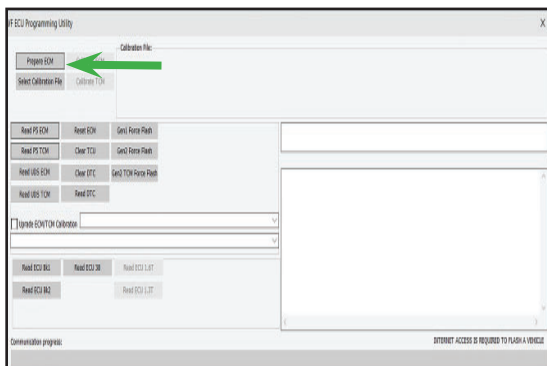

Legacy flash device ONLY

45. Follow the prompt on screen and click “Select Calibration File”.

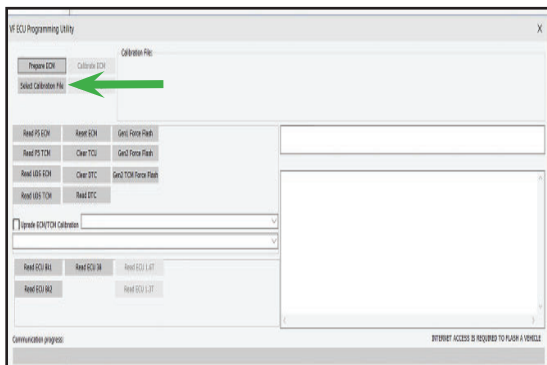

Legacy flash device ONLY

46. Click on calibrate ECM and follow the prompts on the screen. Progress bar will be completely green when it is complete.

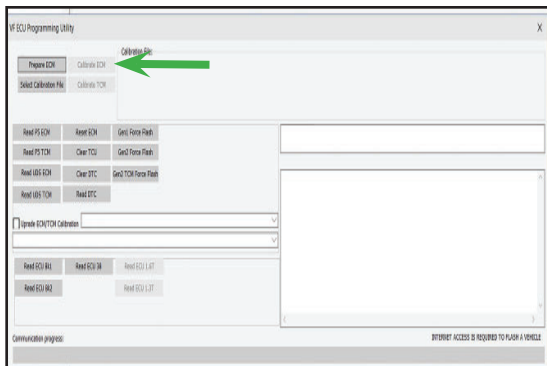

WiFlash device ONLY

47. Click on the WiFlash Icon.

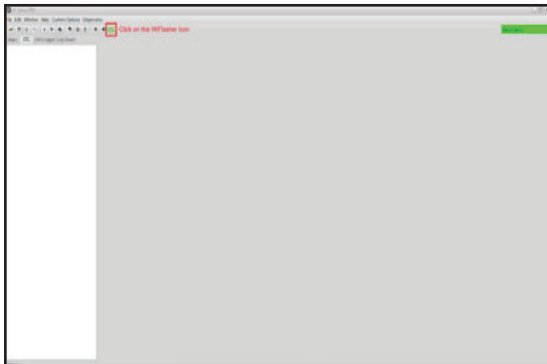

WiFlash device ONLY

48. The WiFlash Vehicle Programming Utility window will pop up. Make sure that the “Log Connection to File” is **NOT checked**. Verify that there is a text on the “Device” dropdown. > if the dropdown is empty, then the WiFlash device cannot be detected.

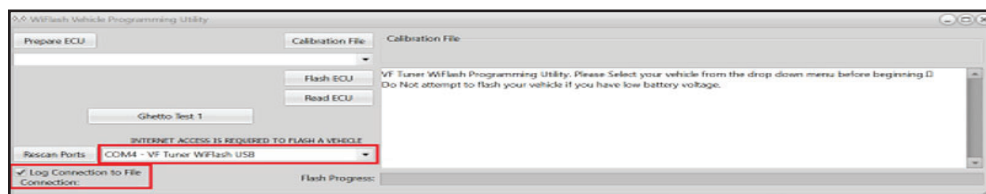

WiFlash device ONLY

49. Click on the dropdown menu and select the Toyota Gen 2 1.5/2.0MB .

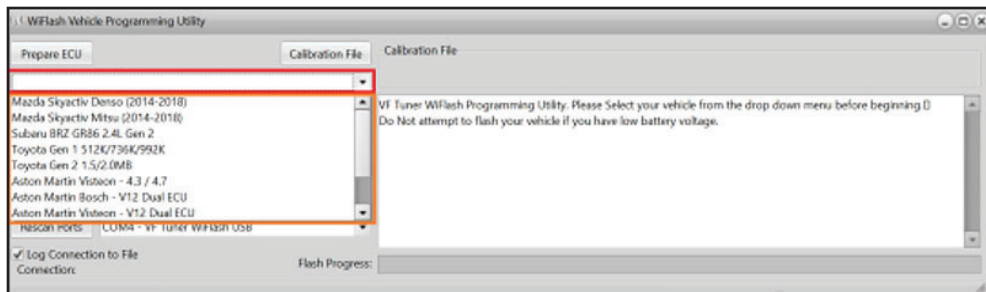

WiFlash device ONLY

50. Turn on your car's ignition. Make sure that:

- All your electrical loads (like air conditioning, headlights, indoor lights, radio, etc) are completely off (or as much as you can turn off)
- Your ignition must be on, but your engine is OFF/NOT idling.
- Place your car keys as near as you can to the start/stop button.
- Make sure you have at least 12V of power from your battery and can maintain that voltage for the duration of the flash.
- Check the connections of your WiFlash/Legacy device to the laptop and to the OBD2 port.
- Do not move the laptop or the WiFlash/Legacy device to prevent connection loss.
- Wait 15-20 seconds before proceeding to the next step.

WiFlash device ONLY

51. Click the "Prepare ECU" button."

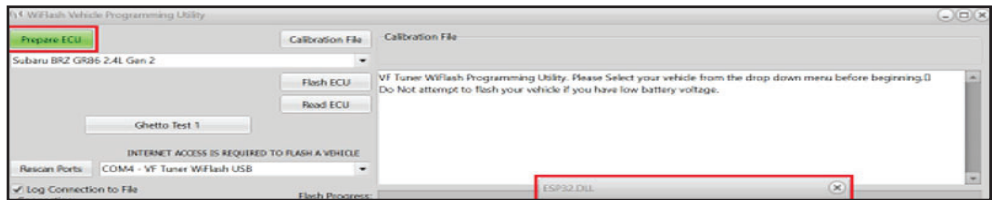

WiFlash device ONLY

52. Click on calibration file. Select the file that was sent to you.

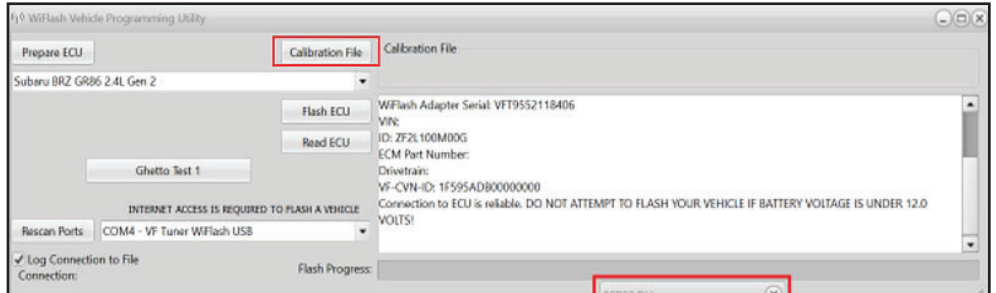

WiFlash device ONLY

53. Click on Flash ECU. Follow the onscreen prompts.

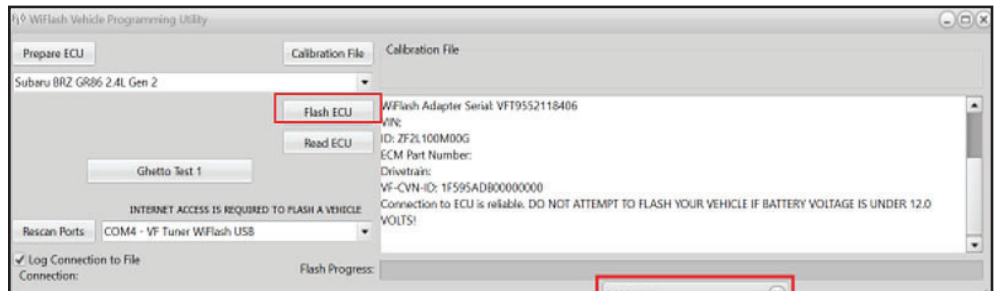

NOTES

If you have any troubles with this process contact our technical support at support@magnusonsuperchargers.com or call 1-805-642-8833 (Press Option 3).



MAGNUSON
SUPERCHARGERS

1990 Knoll Drive, Building A
Ventura, CA, 93003
www.magnusonsuperchargers.com
1.805.642.8833