

MAGNUSON

SUPERCHARGERS

Installation Instructions for:
2005 - 2015 Toyota Tacoma 4.0L



Step-by-step instructions for installation of
the supercharger system.

*** PREMIUM GASOLINE FUEL REQUIRED ***



ATTENTION!
Your **MAGNUSON SUPERCHARGER** kit
is sensitive to corrosion!
Use only the vehicle manufacturer
recommended coolant for your engine in
the intercooler system as well.

Magnuson Products LLC
1990 Knoll Drive, Bldg A, Ventura, CA 93003
(805) 642-8833 phone
magnusonsuperchargers.com

INSTALLATION MANUAL

Magnuson Supercharger Kit: Toyota Tacoma 4.0L

Please take a few moments to review this manual thoroughly before you begin work: Make a quick parts check to be certain your kit is complete (see Bill of Material (BOM) parts list inside the accessory box). If you discover shipping damage or shortage, please call our office immediately. Take a look at exactly what you are going to need in terms of tools, time, and experience. Review our limited warranty with care.

Use only premium gasoline fuel, 91 octane or better.

Magnuson Products recommend that you run a minimum of one (1) tank of premium fuel through your vehicle prior to installation of the system to prevent any possible damage that may occur due to running the supercharged engine on lower octane fuel.

Magnuson Products Supercharger systems are designed for engines and vehicles in "GOOD" mechanical condition. Magnuson Products recommend that a basic engine system "Health Check" be performed prior to the installation of this supercharger system. Be sure to check for any pending or actual OBDII codes and fix/repair any of the stock systems/components causing these codes. If there are codes prior to the installation they will be there after the installation.

Magnuson Products also recommend the following services to be performed on your vehicle before starting and running the vehicle post supercharger system installation:

- Fuel Filter change
- Engine oil and filter change using brand name oil (organic or synthetic) and filter

Note: It is VERY IMPORTANT to use the factory specified oil viscosity. The original equipment manufacturer has selected this grade of oil to work with your other engine systems such as hydraulic chain tensioner and variable cam controls. Deviation from this specification may cause these systems to fail or not function properly. Please refer to your owner's manual for the recommended oil viscosity for your engine and application.

On older vehicles Magnuson Products recommend these additional services to be performed:

- Coolant system pressure test and flush. **NOTE: YOU MUST USE TOYOTA SPECIFIED COOLANT MIXTURE!**

Non "Magnuson Approved" calibrations or "tuning" will Void ALL warranties and CARB certification.

Our supplied calibration is designed for use with the components provided in this kit. Any adjustment to the intake, or exhaust systems or other engine components may adversely affect engine performance and may trigger your check engine light.

Drive belt = DAYCO #21-2973

Tools Required

Metric wrench set

Metric 3/8" and 1/2" drive metric socket set (standard & deep)

3/8" and 1/2" drive ft-lbs and in-lbs torque wrenches

Metric Allen socket set 3/8 drive

Metric Allen wrenches

Phillips and flat head screwdrivers

Serpentine belt tool

Funnel

Drain pan

Hose cutters

Hose clamp pliers

Safety glasses

Nut driver

Compressed air

Impact gun and 24mm impact socket

Air gun

Torx socket set 3/8 drive

Clip removal tool

Telescoping magnet

Anti-sieze assembly lube (for spark plugs)

Contact Information:

Magnuson Products LLC

Magna Charger Division

1990 Knoll Drive, Bldg A

Ventura, CA 93003

Sales/Technical Support Line (805) 642-8833

Websites www.magnusonsuperchargers.com

Email sales@magnusonproducts.com

Table of Contents

Section 1: Initial Preparation	5
Section 2: Intake Manifold Removal	6
Section 3: Fuel Injector Replacement	15
Section 4: Spark Plug Replacement	19
Section 5: Fan Shroud and Radiator Hose Removal	22
Section 6: Auxiliary Drive Installation	26
Section 7: Supercharger Preparation and Installation	34
Section 8: Grill Removal and Intecooler Pump Installation	42
Section 9: Intercooler Reservoir (With Vacuum Brake Booster)	51
Section 10: Intercooler Reservoir (W/O Vacuum Brake Booster)	55
Section 11: Intercooler Pump Wiring Connections	58
Section 12: Vacuum Hose and Air Cleaner Installation	61
Section 13: Coolant Fill and Vehicle Testing	66

NOTE: This instruction manual follows the process we used to complete this installation on our test vehicle. This does not imply there aren't alternate approaches.

Section 1: Initial Preparation

1. The first step of the installation is to connect the Bully Dog tuner to the OBDII port for calibration of your system to function with the supercharger. **Follow the instructions in the provided pamphlet to install your tune.**



2. Your Intercooler system is sensitive to corrosion. It's very important to use the OEM recommended coolant mixture in your supercharger system as well.



3. Your system requires the use of a minimum 91 Octane gasoline fuel. This system is **not** compatible with E85 fuel.

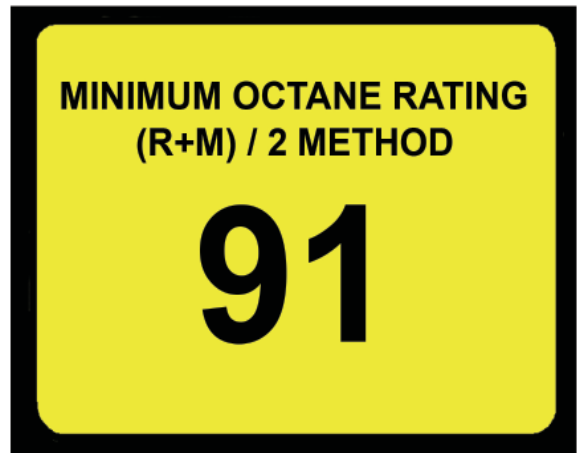

Any reference to the left or right side of the vehicle is given from the driver's seat perspective.

4. Remove the negative battery cable from the battery with a 10mm wrench. The battery is located in the left front area of the engine compartment. Ensure that the cable, and lead are covered with a rag or other suitable insulator to avoid accidental connection.

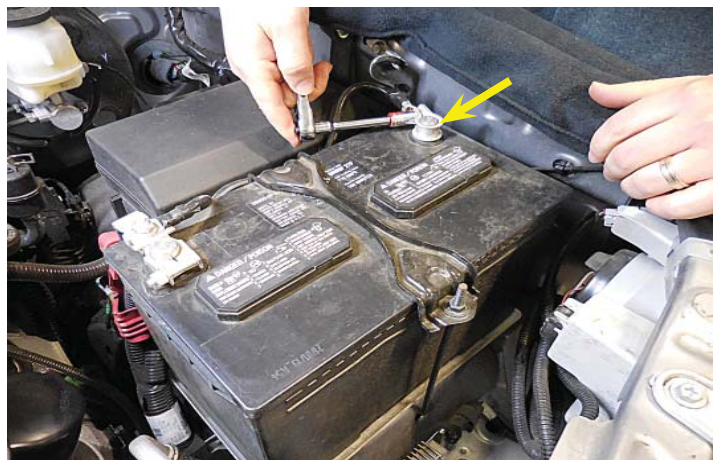

Section 2: Intake Manifold Removal

5. Remove the engine cover by removing the two acorn nuts shown with arrows.



6. Disconnect the ventilation hose shown with an arrow. View of skid plate being removed.



7. Disconnect the vacuum hose.

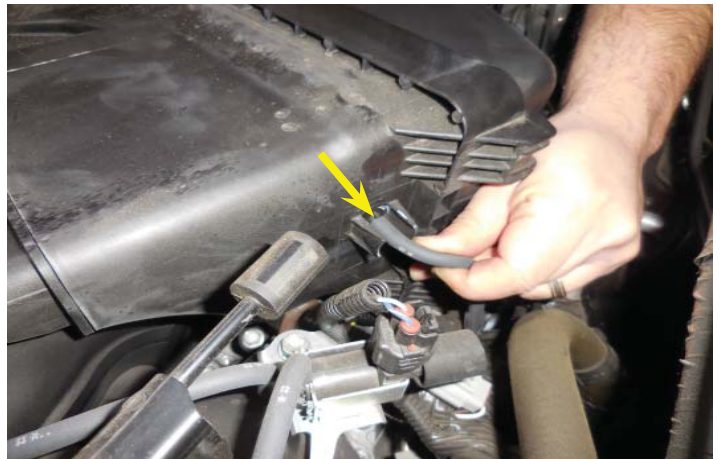

8. Unplug the mass air flow meter connector.



9. Remove the wire harness clamp shown with the arrow.



10. Remove the second wire harness clamp shown with the arrow.



11. Loosen the hose clamp at the air box.



12. Remove the hose clamp at the throttle body shown with an arrow.

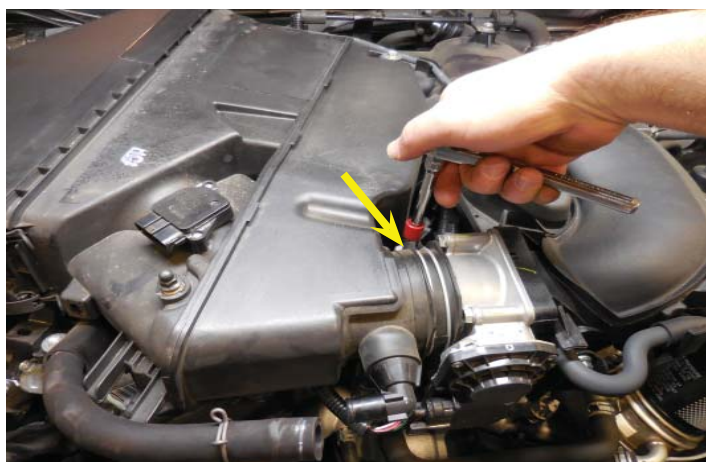

13. Remove the two bolts shown with arrows.

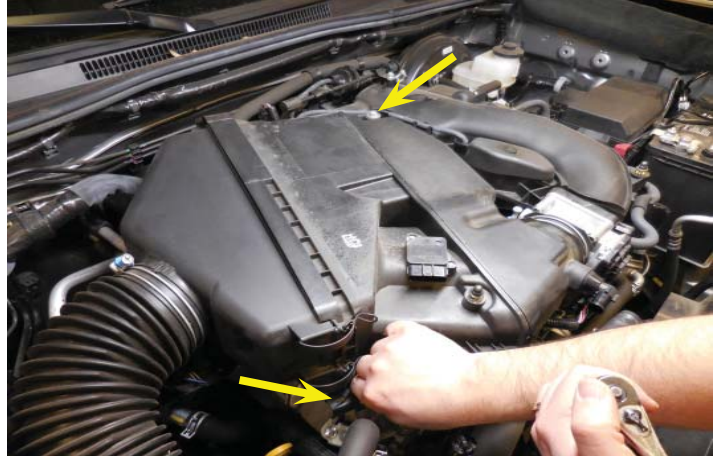

14. Remove the air box.



15. Disconnect the throttle body connector.



16. Remove the 4 bolts, and then remove the throttle w/ motor body and gasket.



17. Leave the throttle body connected to the coolant hoses for now.



18. Disconnect the fuel vapor feed hose.



19. Disconnect the brake booster feed hose shown with an arrow.



20. Disconnect the ventilation hose shown with an arrow.



21. Disconnect the VSV connectors.



22. Disconnect the cable connector shown with the arrow.



23. Disconnect the ACIS connector shown. Use electrical tape to cover this connection and secure it to the wiring bundle as it will not be re-used.



24. Disconnect the harness connector shown.



25. Disconnect the cable tie for the harness shown with an arrow.



26. Remove the 4 coolant hose clamps and hose clamps shown with the two yellow arrows.



27. Remove the bolt that secures the bracket shown with the arrow.



28. This bracket must be removed to gain clearance for the supercharger.



29. Remove the front upper bolt shown with an arrow.

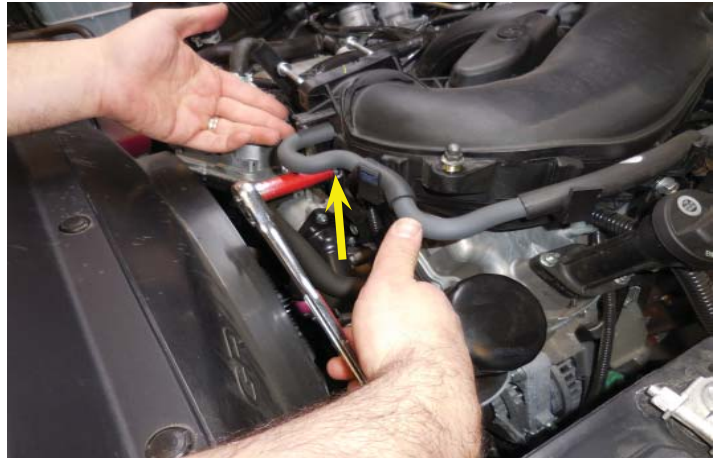

30. Remove the 2 bolts shown with arrows which are used to secure the 2 surge tank stays.



31. Remove the bolt that holds the front side bracket to the side of the cylinder head shown with an arrow.



32. Remove the bolt that holds the rear bracket to the side of the cylinder head shown with an arrow.



33. Remove and discard the bracket attached to the front of the cylinder head (Bracket stamped "A").



Wear Safety Glasses when using Compressed air

34. **CAUTION:** Before proceeding, make sure there is no dirt or debris on or around the base of the surge tank. If there is, you must remove it so that it will not enter the engine when the surge tank is removed.

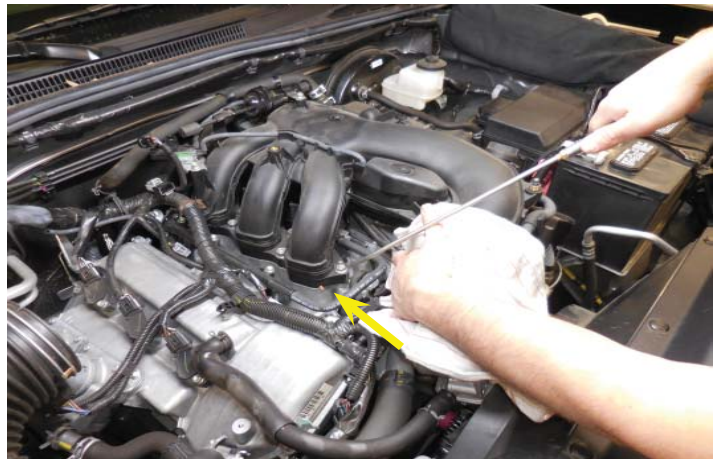

35. Using an 8mm Allen socket, remove the 4 bolts (shown with yellow arrows) and the 2 nuts (shown with green arrows) with a 12mm socket. Remove the surge tank and gasket.



36. A magnet will help to remove the nuts from their locations.



37. Remove the surge tank and gasket.



38. The engine is shown with the manifold removed. Clean intake port areas with a clean dry rag. Then use Simple Green or other appropriate degreaser to clean port surfaces. Vacuum out any debris from the intake ports. Ensure that nothing gets inside the combustion chamber.

It is VERY important to not contaminate your work environment or allow any debris to fall into the exposed ports, or engine damage can occur.



39. Cover the ports with tape. Do not cover the studs with tape because they will be removed in the next step.



40. Remove the studs using an E-5 internal Torx socket. A 5 mm socket may also work if you do not have an E-5 Torx.



Section 3: Fuel Injector Replacement

41. Remove the gas cap, and leave it off to allow fuel pressure relief.

Warning: The Fuel System is under High Pressure. Use Safety Glasses and Fuel Compatible Gloves to prevent Personal Injury

Remove any dirt and foreign objects from the connectors before performing this work. Do not allow any scratches or foreign objects on the parts when disconnecting, as the fuel tube connector has the O-ring that seals the pipe. Perform this work by hand. Do not use any tools. Do not forcibly bend, twist or turn the nylon tube. Protect the disconnected parts by covering them with a plastic bag after disconnecting them. If the fuel tube connector and pipe are stuck, push and pull to release them.

42. Place a rag down to catch any fuel runoff. Remove the fuel pipe clamp shown with the arrow.

43. Pinch the tube connector, and pull the fuel pipe out of the connector as shown.

44. Repeat the process from the two previous steps for the No. 2 fuel pipe shown with an arrow.

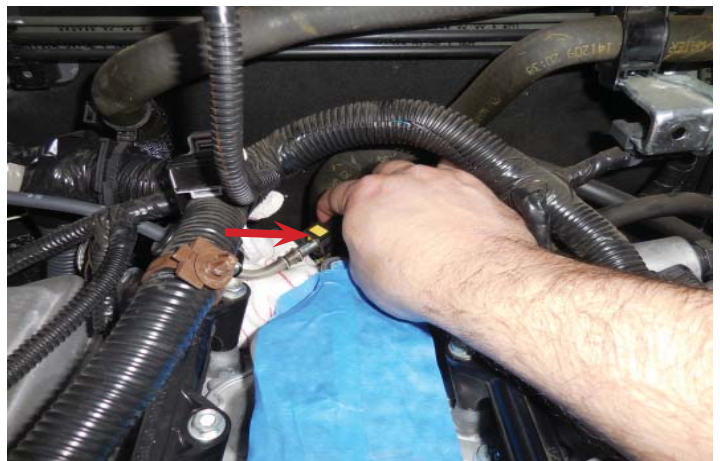
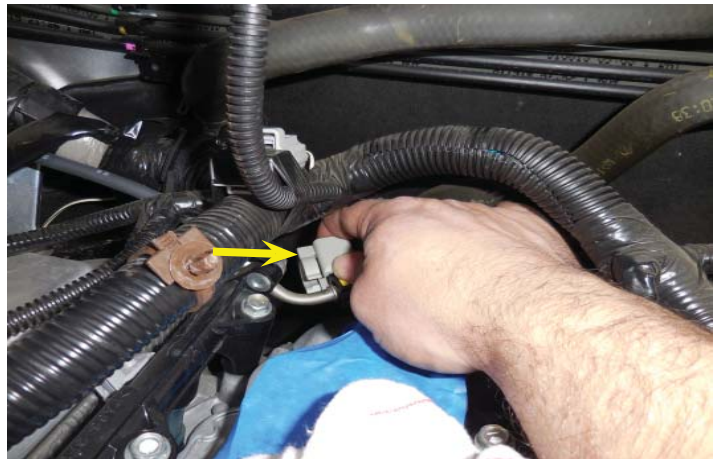

45. Disconnect the 6 fuel injector electrical connectors.



46. Remove the 6 bolts holding the fuel delivery pipes in place.

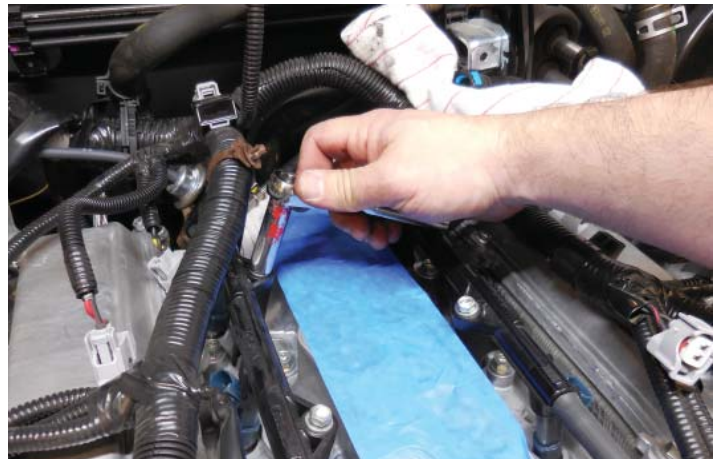

47. Remove the fuel delivery pipes together with the 6 fuel injectors.



48. This photo shows the fuel delivery pipes, with the OEM fuel injectors along with the provided fuel injectors shown with an arrow.



49. Pull the 6 injectors out of the delivery pipe. Discard the injectors as they will be replaced with new higher flow injectors. The old injectors should be saved for the customer.

NOTE: The new injectors have Mustard colored bodies, while the OEM injectors have Blue colored bodies.



50. Install a light coat of spindle oil or gasoline to the O-ring on the top of each new injector. While turning the fuel injector left or right, install it onto the fuel delivery pipe positioning the connector facing outward. Repeat for all six new injectors. Apply a light coat of spindle oil on the injector insulators. Install insulators in the lower intake manifold



51. Inspect the injector insulators for damage and wear. If wear or damage exists, replace the insulator with Toyota part number 23291-23010 or equivalent superseded part.



52. If the injector insulators are not located on the OEM injectors you will have to extract them from the intake manifold.



53. Clean the injector insulators and install them onto the new injectors. Ensure that the thicker edge of the insulator gets installed on the injector first. This will allow the injectors to get located easier onto the intake manifold.

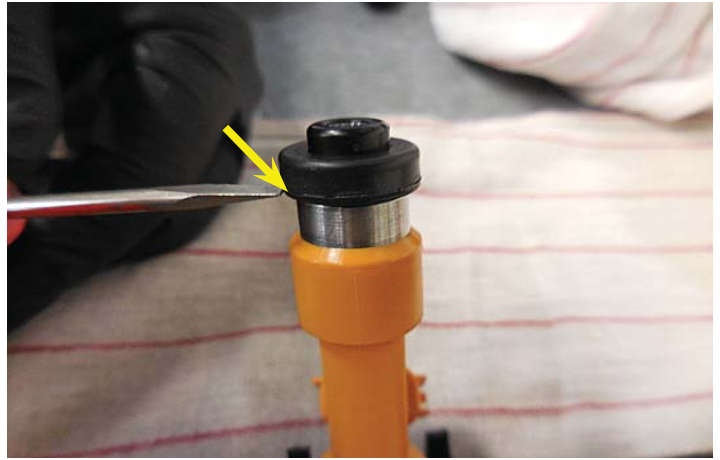

54. Place the fuel delivery pipe together with the new injectors on the intake manifold. Provisionally install the 6 bolts, which are used to hold the delivery pipe, onto the intake manifold. Check to see that the injectors rotate smoothly. Position the injector connectors facing outward.



55. Torque the 6 bolts to **15 Nm (11 ft lbf)**.



56. Reconnect the 6 fuel injector electrical connectors. Reconnect the No. 1 and No. 2 fuel pipe sub-assemblies to the fuel delivery pipe connectors by pushing together until the connector makes a “click” sound. After connecting, check that the pipe and connector are securely connected by pulling on them. Reinstall the clamps on each connector. Re-install gas cap.

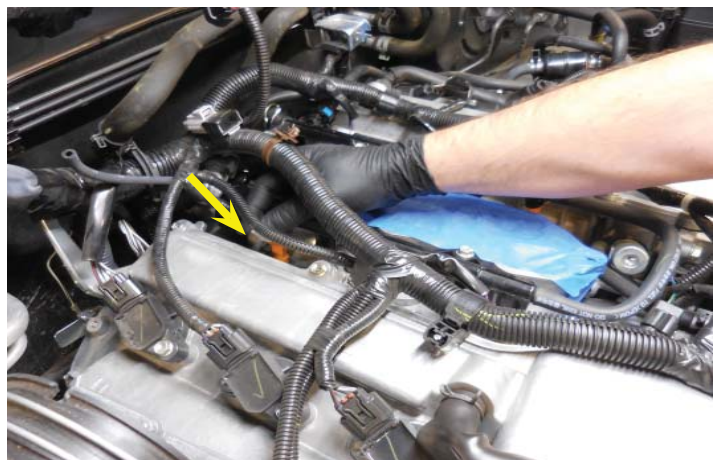

Section 4: Spark Plug Replacement

57. To ensure clearance to the supercharger manifold, pry the wire loom retainer up off the stud on the left cylinder head cover. **NOTE: Do not omit this step.**



58. Unplug the electrical connector from each of the 6 ignition coils.



59. Remove the 6 bolts holding the ignition coils in place.

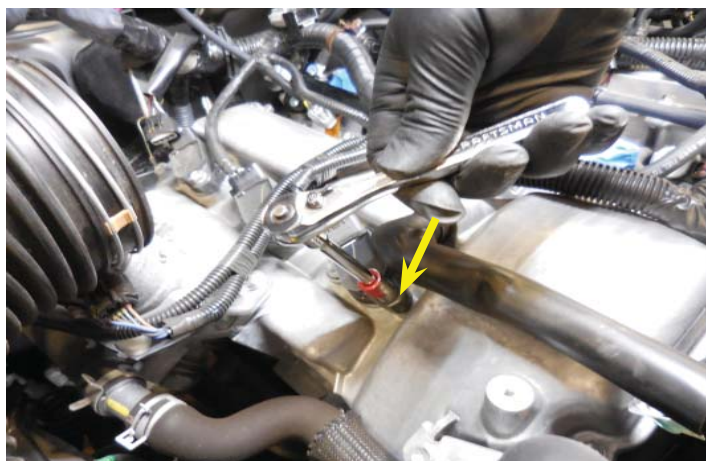

60. Remove the 6 ignition coils.



61. Push the hose shown with the red arrow out of the way to allow the left rear ignition coil to be removed.



Wear Safety Glasses when using Compressed air

62. **CAUTION: Blow any dirt or debris from around the spark plugs before removing them.**



63. Remove the 6 spark plugs and discard them in a box for the customer. New colder plug will be installed.



64. You can use a magnet to extract the spark plugs from their bores.



65. Set Spark Plug Gap at **0.8 mm (0.032")**. A little anti-seize on the plug threads will prevent seizing in the future.



66. Use a piece of hose that will fit tightly around the plug (or a spark plug socket) to hand thread the 6 new spark plugs into place.



67. Thread the plugs in place using a socket and extension. Torque the spark plugs to **20 Nm (15 ft lbf)**.



68. Reinstall the ignition coils and the bolts and torque them to **10 Nm (7.4 ft lbf)**.



69. Reinstall the electrical connection for the ignition coil.



Section 5: Fan Shroud and Radiator Hose Removal

70. Remove the 9 plastic clips from the black plastic seal cover at the top of the radiator.



71. Set aside the seal cover for re-installation later.

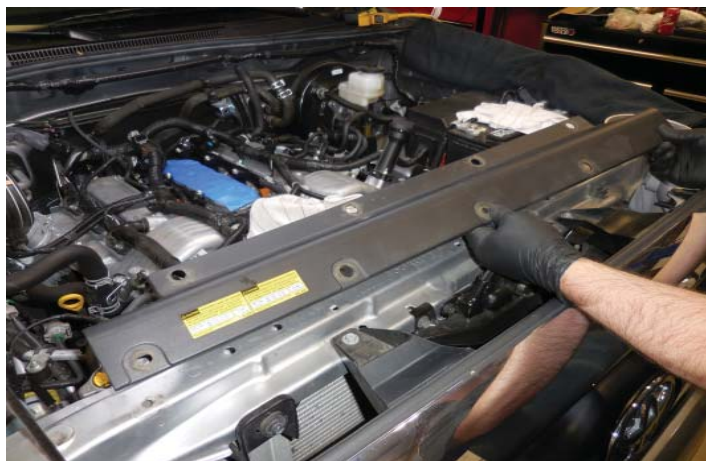

CAUTION: To avoid the danger of being burned, do not remove the radiator cap while the engine and radiator are still hot. Thermal expansion will cause hot engine coolant and steam to blow out from the radiator.

72. Remove the radiator cap and set it aside.



73. Remove the service hole cover from the engine under cover. NOTE: On some vehicles it may be necessary to remove the skid plate. Have a clean pan ready for coolant. Loosen the drain plug on the radiator (shown with the arrow and located on the right front of the engine).

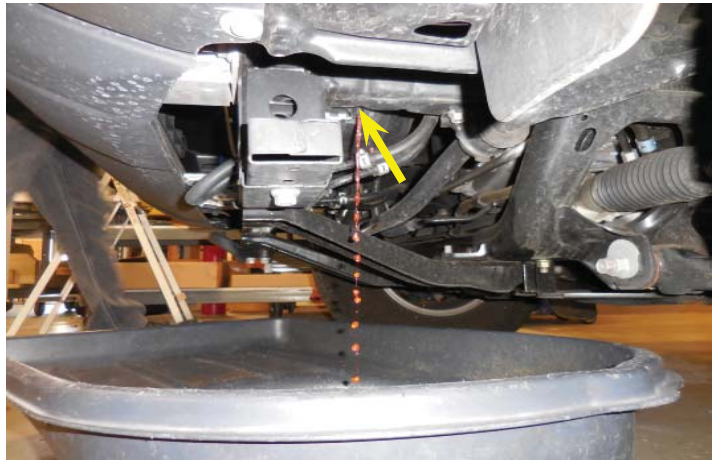

74. After you have drained the radiator you will have to drain the engine. The engine drain plugs are located on both sides of the engine, and have a spigot at the bottom. Once you have drained the engine torque the plugs to **13 Nm (9.0 ft lbf)**.

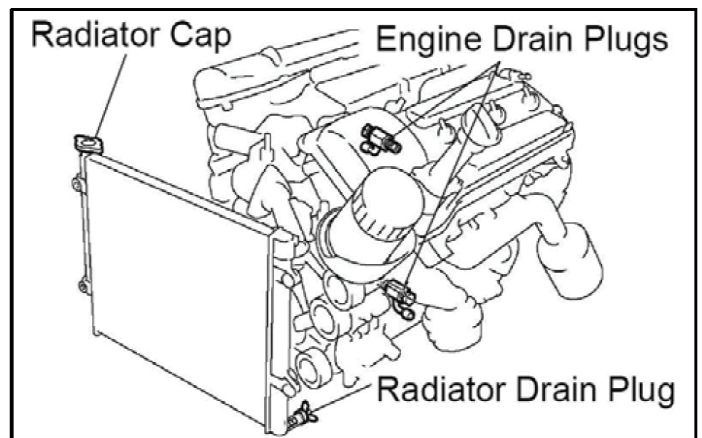

75. Remove the cap for the coolant reservoir tank.



76. Use a large cup to catch the coolant as you drain the coolant reservoir tank.



77. Remove the top radiator hose. Save for reuse.



78. Remove the four nuts that attach the fan/clutch to the fan pulley. Leave the fan in place for now.

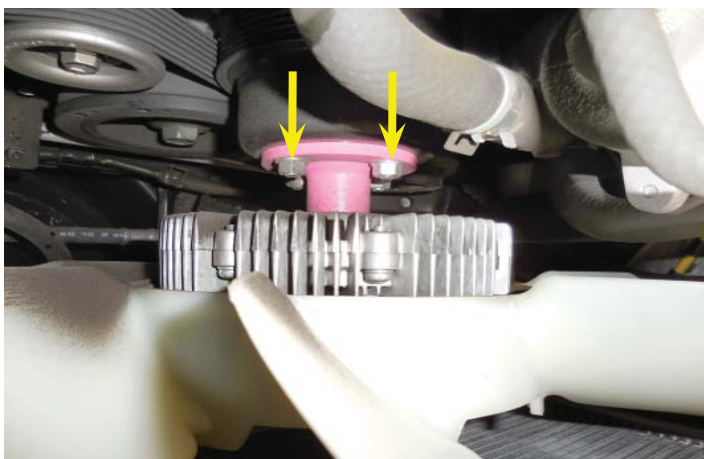

79. Remove the two bolts from the top corners of the fan shroud. One bolt location is shown here. The other bolt is on the left side of the radiator.



80. Disconnect the coolant overflow tube from the radiator. If the vehicle has a transmission oil cooler, it will be necessary to remove a clip holding a fluid line to the shroud.



81. Disconnect the plastic hose clamps shown with the arrow if you have a transmission oil cooler.

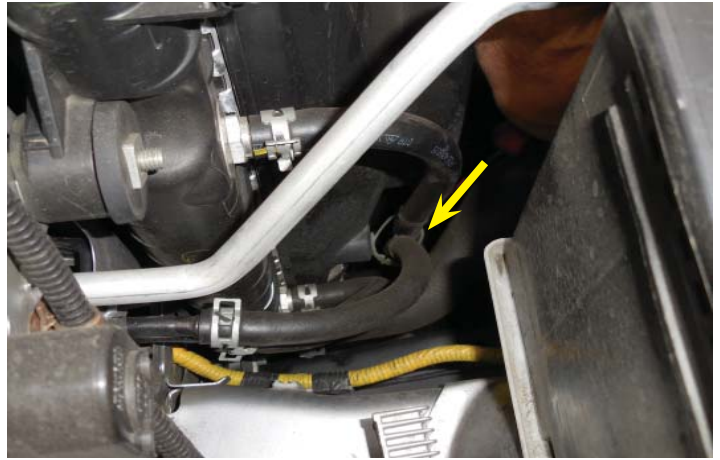

82. Carefully remove the fan and shroud together so you do not damage the radiator. You may need a second person to help you with this step.

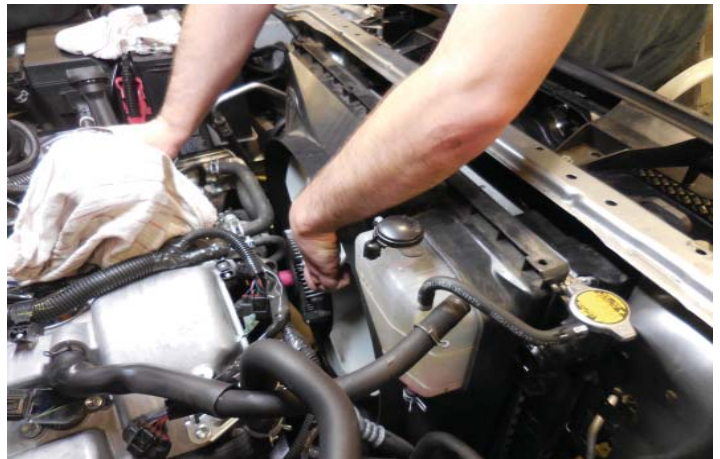

83. Note: Tape a piece of cardboard (about the size of the radiator) to the back side of the radiator to prevent damage during subsequent steps.

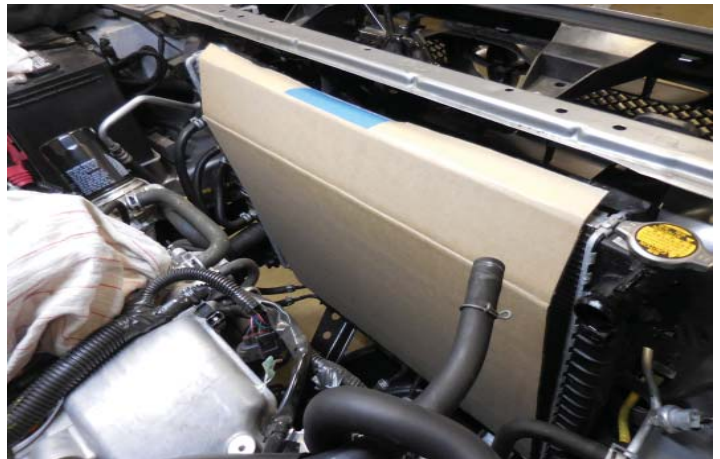

84. Reinstall two of the fan nuts (finger tight) so the fan pulley will not fall off.



85. Remove the lower radiator hose. The hose will not be reused. The ends of this hose are shown with arrows.

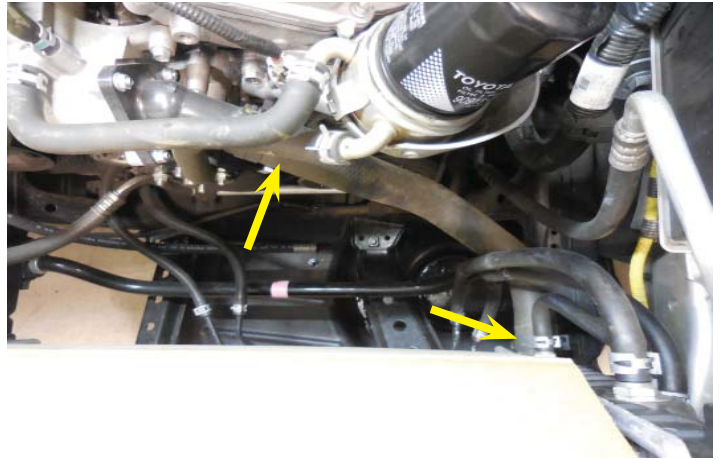

Section 6: Auxiliary Drive Installation

86. While releasing the belt tension by turning the belt tensioner (shown with the arrow) counter-clockwise, remove the belt from the power steering pump pulley. **NOTE: It is not necessary to completely remove the belt.**

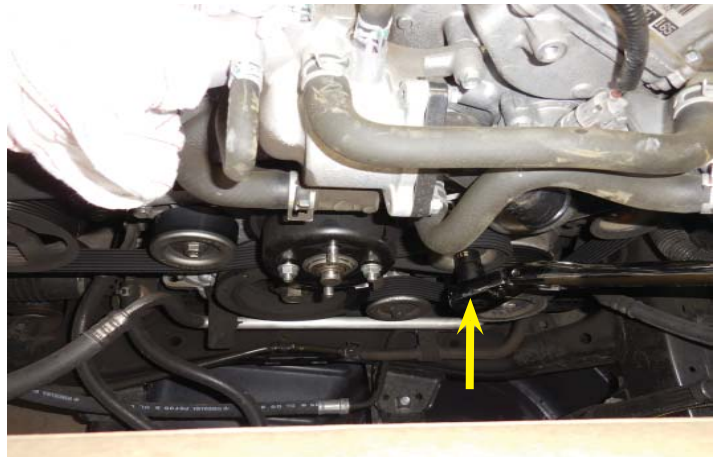

87. Remove Idler No. 1 and discard the bolt. Keep the thin step washer (if present) and pulley for the next step. **NOTE: Some vehicles may not have the thin step washer.**

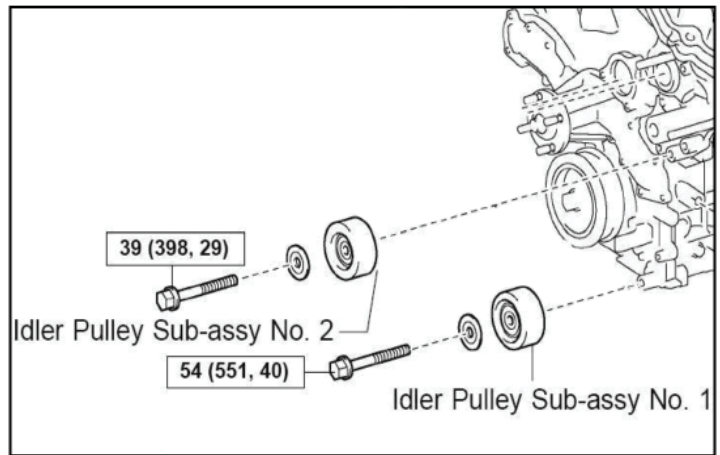

88. Here is a photo of the parts that will be installed in the location where the Idler Pulley Sub-assembly No.1 was just removed. After the M10 stud (shown at the bottom) is installed you will reinstall the original smooth pulley (with the large radius facing away from the engine) and thin step washer (if present), the idler spacer without a groove (smaller diameter facing away from the engine), the 6 rib idler pulley (snap ring facing the engine), and one of the short spacers. Temporarily install the M10 nut finger tight to hold this assembly in place. **The M10 nut will be removed later to install the belt tensioner assembly.**



89. Install one of the double ended M10 studs and snug it in place with a flat blade screwdriver in the location where Idler Sub-assembly No.1 was removed.



90. This photo shows the Idler Pulley Sub-assembly from two steps ago located (shown with a red arrow). Make sure to add the M10 nut finger tight to temporarily retain this assembly. Remove Idler No. 2 (shown with a yellow arrow) and discard the bolt. Keep the thin step washer (if present) and pulley for a later step. **NOTE: do not mistake Idler No. 2 for the tensioner pulley.**



91. Here is a photo of the parts that will be installed in the location where the Idler Pulley Sub-assembly No. 2 was just removed. Reinstall the original smooth pulley (with the large radius facing away from the engine) and thin step washer (if present), the idler spacer with a groove (smaller diameter facing away from the engine), the smooth idler pulley, and the other short spacer. Temporarily install the M10 nut finger tight.

The M10 nut will be removed later to install the belt tensioner assembly.



92. Install the other double ended M10 stud in the location where idler No. 2 was removed two steps ago and snug it in place with a flat blade screwdriver.



93. This photo shows the Idler Pulley Sub-assembly from two steps ago located. Make sure to add the M10 nut finger tight to retain this assembly. **This M10 nut will be removed later to install the belt tensioner assembly.**

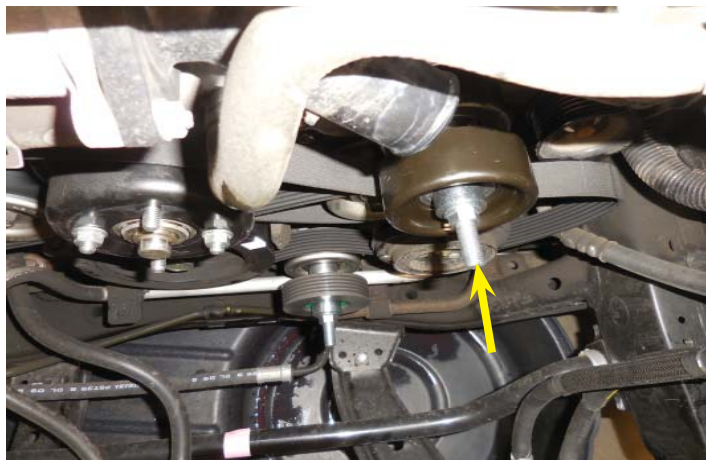

94. Reinstall the fan and generator belt.



95. Using an impact gun, remove the bolt and washer that secures the crankshaft pulley.



96. Discard the bolt and washer. **Do not remove the pulley.**



97. This photo shows the supplied washer bolt, and pulley that will be installed at the crankshaft pulley location.



98. Observe the location of the keyway in the OEM pulley (shown with an arrow). The supplied pulley has a pin that will locate with this keyway.

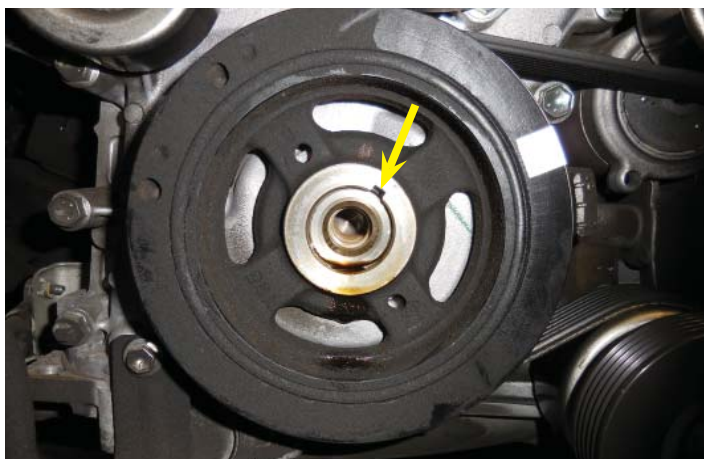

99. Clean the end of the crankshaft prior to installing the provided pulley.



100. Install the supplied crankshaft pulley in front of the existing crankshaft pulley making certain that the dowel pin in the new pulley is aligned with the key way in the existing pulley using the new supplied bolt and washer. **Torque the bolt to 277 Nm (204 ft lbf).**



101. Install the blower drive belt as shown. Refer to the diagram at the back of this manual for proper belt routing.

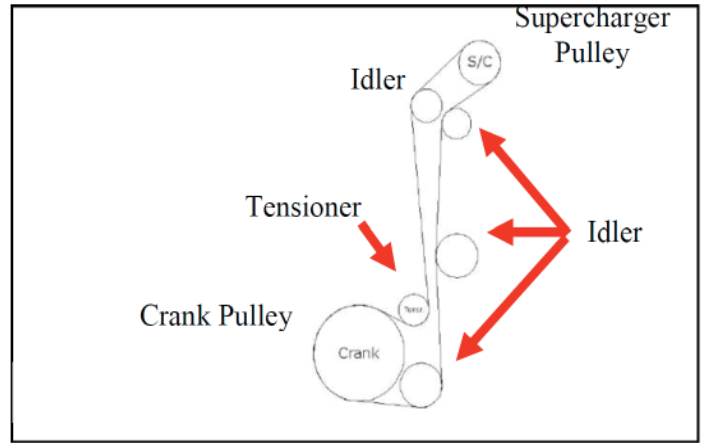

102. Remove the 2 M10 nuts that were installed previously on the two studs (shown with arrows).

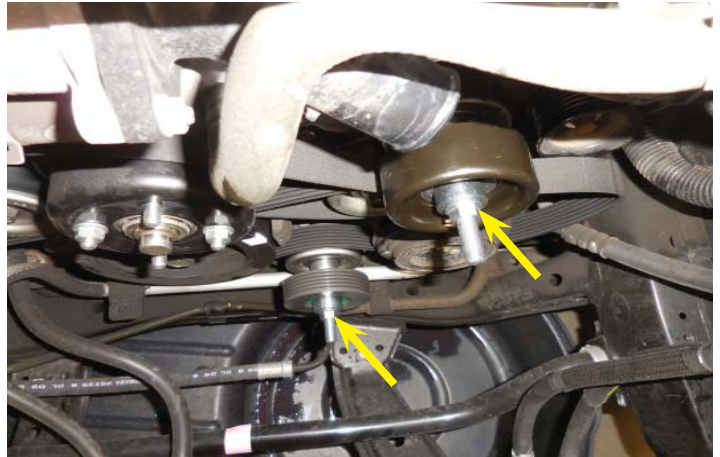

103. Install the belt tensioner assembly onto the two double ended studs previously installed. Make sure both sides of the blower drive belt are free between the tensioner pulley and the upper idler pulley. Reinstall the two M10 nuts finger tight (shown with arrows).



104. Remove the top/forward AC compressor mounting bolt. **CAUTION: Do not remove the bolts that attach the AC lines to the compressor.**

Cooler Compressor Assy

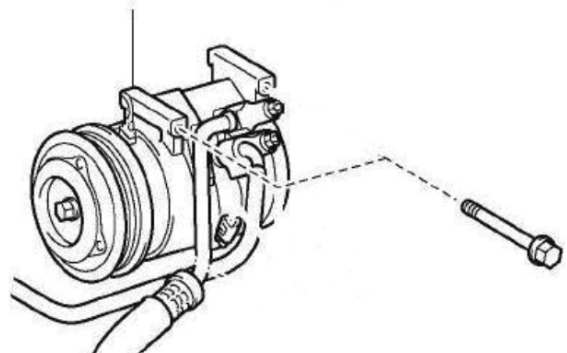

105. Using the bolt removed in the previous step, attach one end of the supplied tensioner support bracket (highlighted in green behind the belt) to the AC compressor finger tight. Attach the other end of the support bracket to the belt tensioner bracket using an M8x16 bolt. Tighten the two M10 nuts, then M8x16 bolt, and finally the AC Compressor bolt. **NOTE: Notice that the bracket goes behind the belt. Also be sure the blower drive belt is on the bottom of the tensioner pulley.**



106. Torque the **M10 nuts to 39 Nm (29 ft lbf)**. Torque the **M8 nuts to 25 Nm (18 ft lbf)**. Be sure the blower drive belt is on the bottom of the tensioner pulley.



107. Remove 2 throttle body bypass hoses and set the throttle body aside.



108. Remove the 2 small bypass hoses, and the larger bypass hose that are attached to the thermostat water manifold. It is suggested that a diagram be made showing where all the hoses go. Some vehicles may also have 2 oil cooler hoses to remove (shown with red arrows).

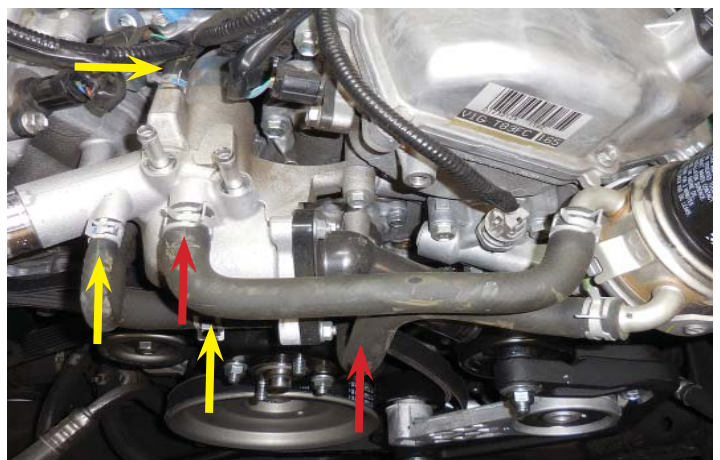

109. Remove and discard the 5 bolts attaching the thermostat water manifold to the engine. Make sure the 2 O-rings remain on the engine.



110. Apply Lubriplate grease to the inside bore of the provided water spacer pipe (shown with a red arrow) and slide it over the OEM O-ring location (shown with a green arrow). Ensure that the O-ring does not get pinched while sliding the water pipe spacer in place. Install the small provided O-ring (shown with the blue arrow) onto the supplied water pipe spacer. Apply a small amount of Lubriplate grease to the O-ring and inside the bore of the thermostat water manifold.

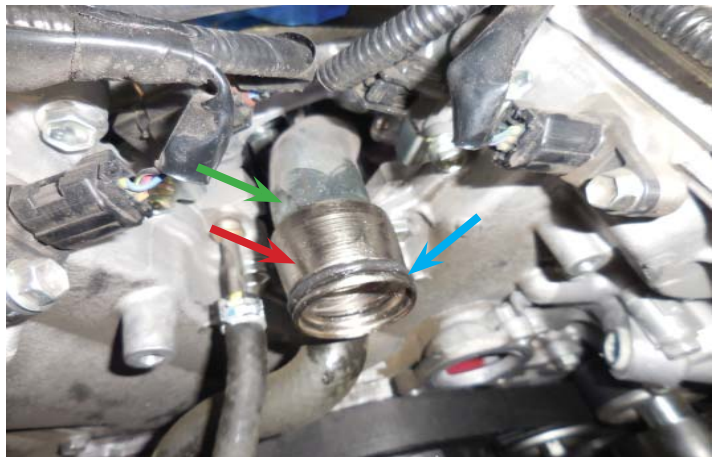

111. Install 3 of the provided M6x55 bolts in the thermostat water manifold.

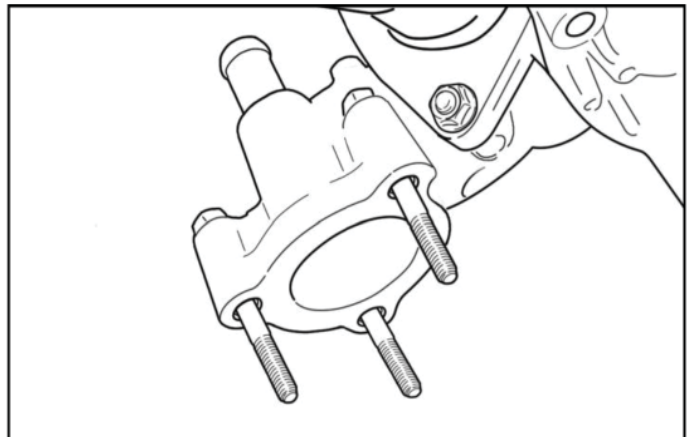

112. Install the supplied large O-ring in the groove of the provided thermostat spacer, a small amount of grease will help hold it in place, and then place the spacer on the 3 bolts with the O-ring facing the thermostat water manifold.

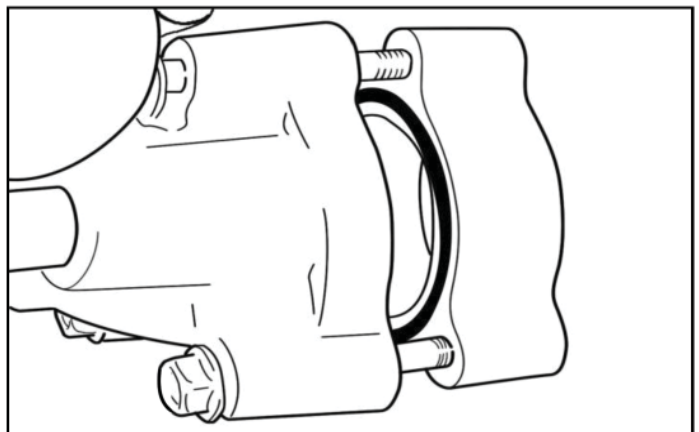

113. Install the thermostat water manifold back onto the engine making sure the 2 O-rings are still in place on the engine. Start the 3 bolts, but do not fully tighten them at this time. **CAUTION: Make sure all O-rings stay in place.** Using the 2 spacers (shown with arrows), place them between the thermostat water manifold and the engine at the 2 remaining mounting bosses and insert the 2 remaining M6x55 bolts.

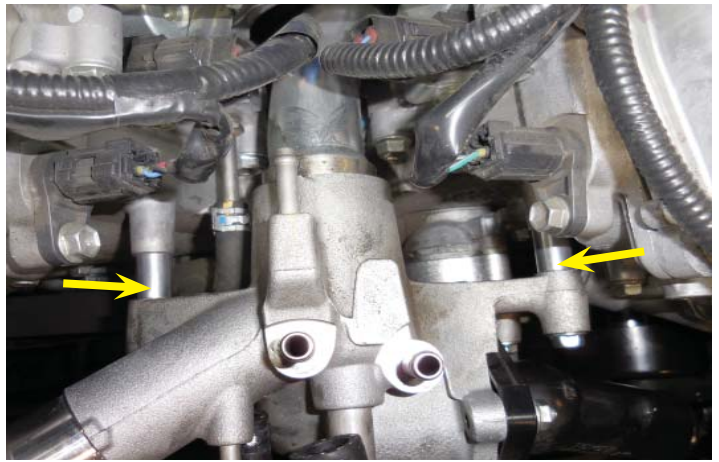

114. Torque all 5 bolts to **9 Nm (80 in lbf)**.



115. If the vehicle has an oil cooler, $\frac{1}{2}$ " will need to be cut from the ends of the coolant lines where they attach to the thermostat water manifold (highlighted in green).



116. Here the hoses from the last step are being cut.

CAUTION: IF THIS STEP IS OMITTED, THE HOSES WILL HIT THE FAN.



117. Reconnect all hoses, except for the radiator hoses, to the thermostat water manifold using the OEM spring clamps.



Section 7: Supercharger Preparation and Installation

118. On the left side of the engine, remove the rear intake manifold support bracket (surge tank stay No. 2) and replace it with the provided support bracket. Note: the original bracket is stamped with a "C" and the provided bracket is stamped with a "B". Leave the attaching bolt finger tight. Make sure you use the same threaded bolt hole on the engine. If the vehicle has a manual transmission, remount the clutch hydraulic line bracket to the new support bracket.



119. Unclip the A/C wire from the stud on the cam cover and the alternator bracket. Unclip the power harness from the bracket on the front surge tank stay. Unbolt the wire harness bracket from the front surge tank stay and invert the harness bracket 180 degrees. Torque: **9 Nm (80 in lbf)**. Remove left side front air surge tank stay from the cylinder head and reinstall the power harness routed behind the bracket to the rear of the engine. Leave the bracket loose for now. Re-clip the wire harness back onto the harness bracket on the surge tank stay (shown with a red arrow). Re-clip the A/C harness back onto the alternator bracket making sure the wires are not pulled tight.

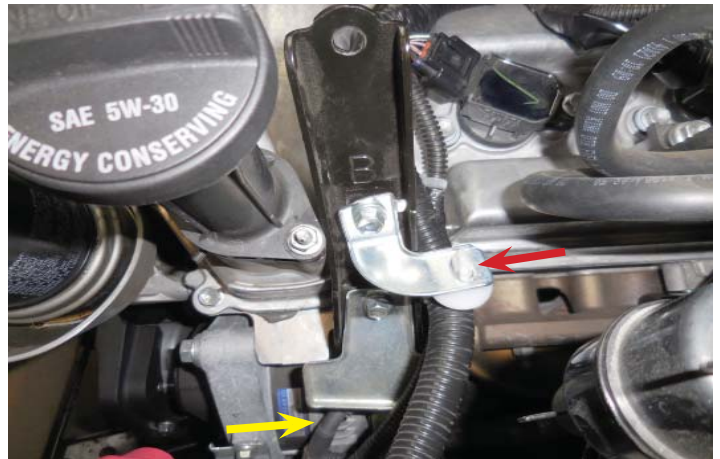

Note: The A/C conductors remain forward of the surge tank stay or under, not rearward (shown with a yellow arrow).

120. Remove the throttle body O-ring from the intake air surge tank (shown with a red arrow).



121. Here is the throttle body O-ring. Clean the O-ring and inspect it for any damage. Replace as necessary. Note the tab on the O-ring that will be aligned with the slot on the new intake manifold.



122. Install the throttle body gasket at the location shown on the supercharger assembly. Ensure that the alignment tab is positioned properly.



123. Remove the intake port gasket from the OEM air intake surge tank. **CAUTION: Do not damage the port gasket.** If the gasket appears to be damaged or excessively worn, replace the gasket with Toyota part number 17176-0P010 or 17176-31010 or equivalent superseded part. Install the intake gasket on the supercharger housing (shown in this photo). The molded gasket and O-ring should fit snugly in the grooved recesses in the housing.



124. Turn the supercharger housing upright and remove the 12 M6 bolts that attach the top cover. Retain these bolts. **CAUTION: Do not remove the larger bolt between the two coolant bars (location shown with red arrow).** Record the serial number which is located at the yellow arrow location for warranty purposes. The serial number is also located on the shipping box.



125. Carefully lift the cover up removing it from the main housing. Note: the charge air cooler will come out attached to the cover. It is bonded to the cover. **DO NOT SEPARATE it from the lid.** Set the assembly upside down so the foam seal is not damaged. The sealing O-ring should remain in the groove in the main housing.



126. Preinstall the provided 6 special reduced diameter shank M8 intake manifold bolts by threading them into the main housing. By reinstalling these bolts into the housing, the possibility of dropping them into the engine ports is reduced. When the bolts are fully threaded in, they will float up and down on reduced diameter shanks.



127. Disconnect and remove the 2 harness clamps on the left side valve cover (one is shown with the arrow).



128. Move the electrical harness away from the stud locations that they were mounted to as shown in this photo.



129. Remove the tape covering the intake ports in the engine manifold. Make sure the surface is clean and that all obstructions have been removed.



130. Carefully, position the supercharger main housing on the intake manifold and hand start the 6 bolts. Do not tighten at this time.



131. Install the original 2 bolts that attach the support brackets (2 surge tank stays) to the supercharger housing. Do not tighten.



132. Lightly tighten the two lower bolts that attach the 2 surge tank stays to the engine.



133. Using the 3 M8 bolts, install the upper idler bracket assembly to supercharger housing (2 places) and the engine cylinder head boss (1 place). Do not tighten.



134. Torque the manifold bolts to **28 Nm (21 ft lbf)** starting from the center and working your way outwards in a criss-cross pattern.



135. Torque the 2 side support brackets at the top and bottom to **28 Nm (21 ft lbf)**.



136. Torque the 3 bolts on the upper idler assembly and the 2 M10 nuts on the lower supercharger belt tensioner assembly to **28 Nm (21 ft lbf)**.



137. After checking to make certain the large O-ring is properly seated in the groove in the main housing, carefully re-install the supercharger housing top cover by lowering it straight down. Fasten with the original 12 M6 bolts. Torque these bolts to **12 Nm (9 ft lbf)**
CAUTION: If the O-ring ends have separated, place a small spot of black RTV over the area where they join before placing the lid in position.



138. Finish installing the supercharger belt drive making sure the routing is correct.

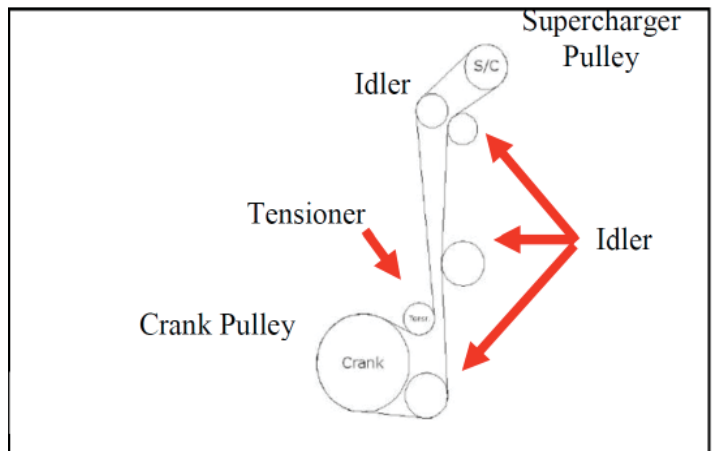

139. Here the supercharger belt drive is being installed.



140. Remove the cardboard from the back of the radiator.

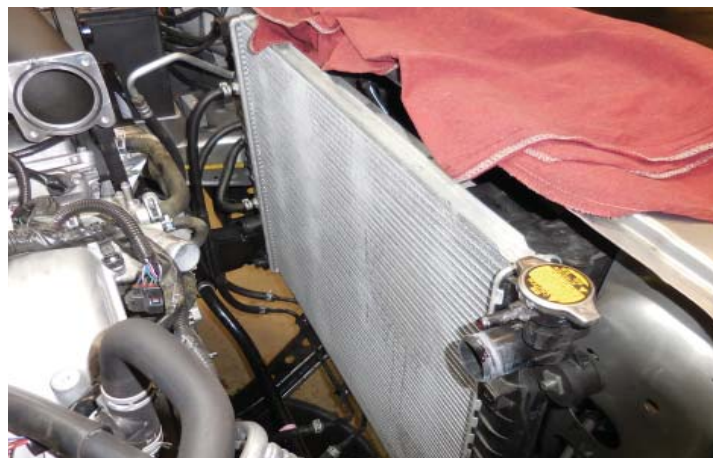

141. Re-install the fan and radiator shroud and tighten all fasteners. Ensure that the tabs at the bottom of the fan shroud engage into their slots. **Torque the fan nuts to 21 Nm (15 ft lbf). Torque the shroud bolts to 5 Nm (44 in lbf).**



142. Re-install the top radiator hose using the OEM clamps.

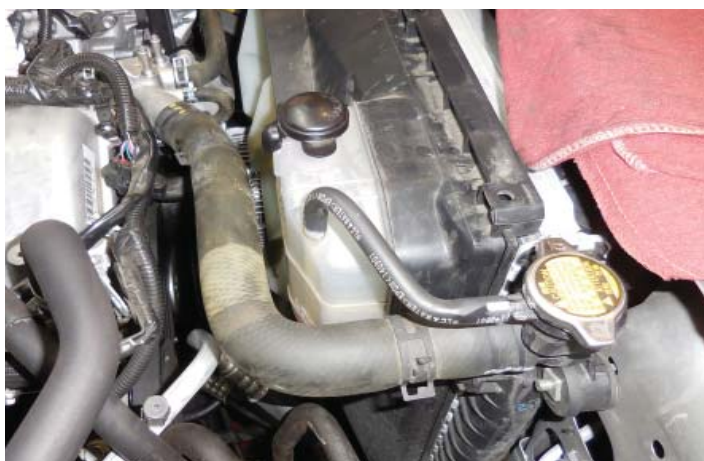

143. Install the throttle body to the supercharger housing. Torque the 4 bolts to **11 Nm (8 ft lbf)**.



144. Re-connect the coolant hoses from the throttle body to the thermostat water manifold.

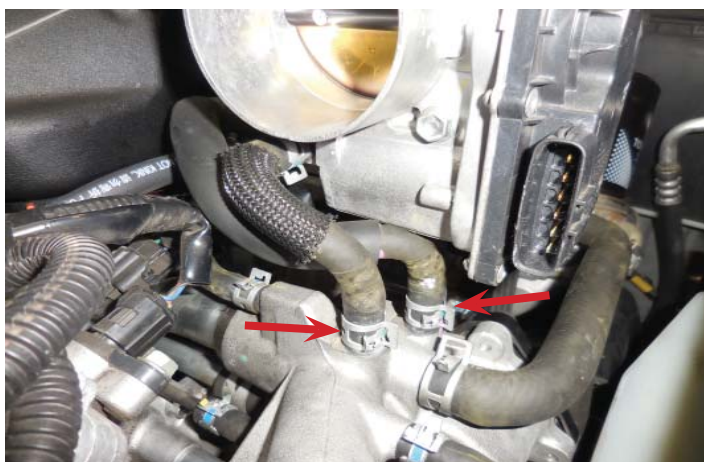

145. Place a clean rag over the throttle body to prevent dirt from entering the intake.



146. It will be necessary to cut 2.5" off the bottom end of the provided lower radiator hose.



147. Using the OEM spring clamps, install the provided lower radiator hose. **CAUTION: Turn the clamps so they do not hit the fan or the belt.**



148. Reconnect the hose clamp to the two hoses shown with the arrow.

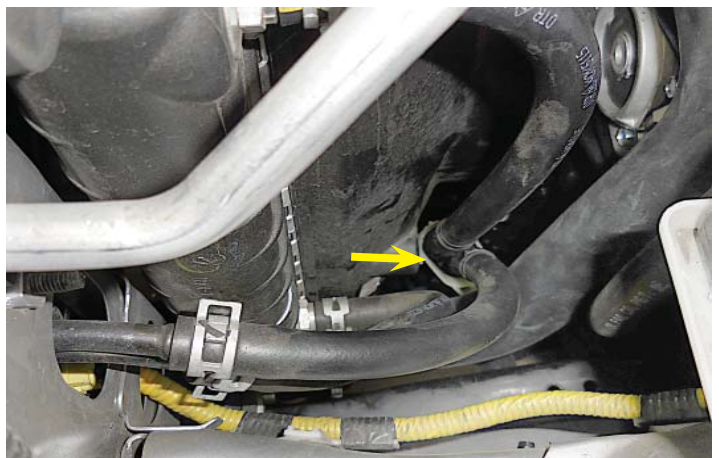

Section 8: Grill Removal and Intecooler Pump Installation

149. Remove the radiator grill by removing the two screws (shown at the blue arrows) and the two rivets (shown at the red arrows). There are 2 lower clips for 2005-2011 MY. For 2012-15 there are 8 guides that must be disengaged.

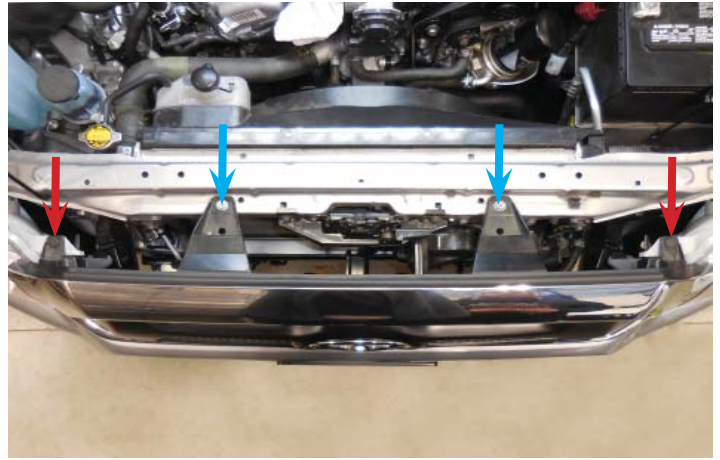

150. Here you can see one of the two bolt locations for the grill being removed.



151. The plastic rivets are removed by pulling up on the center piece first to disengage them, and then the outer piece will come loose.



152. Here is one of the outer lower guides. If you pull up slightly on the tab shown with the arrow while you are pulling out on the grill you will be able to get it to disengage.



153. This photo shows the grill removed.



154. Remove the 2 bolts holding the hood lock release lever protector. Retain these parts.



155. Remove the hood lock release lever protector. This will be modified later for re-installation.

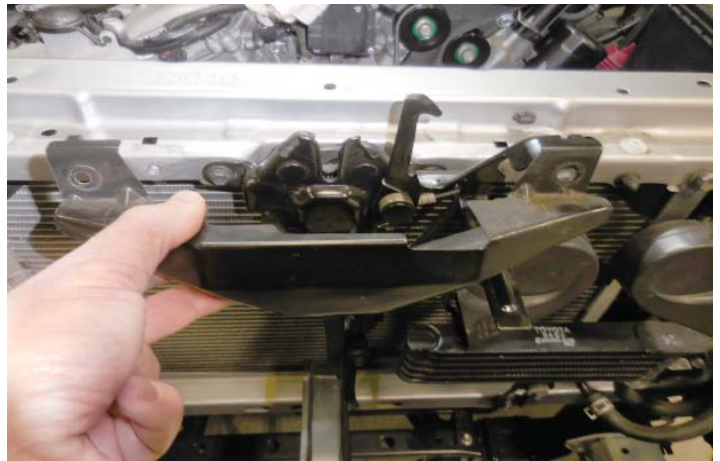

156. Remove the 3 bolts and the hood lock assembly. Retain these parts.

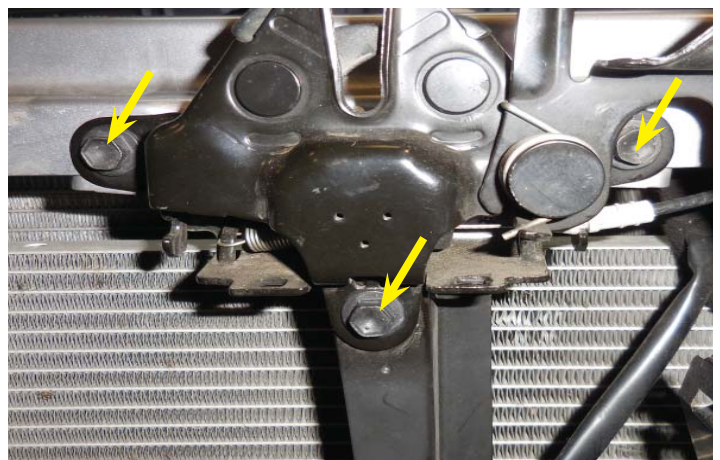

157. Remove the release lever cable by disengaging the ball, and sliding the housing out.



158. Disconnect the electrical connector and remove the horns. Retain these parts.

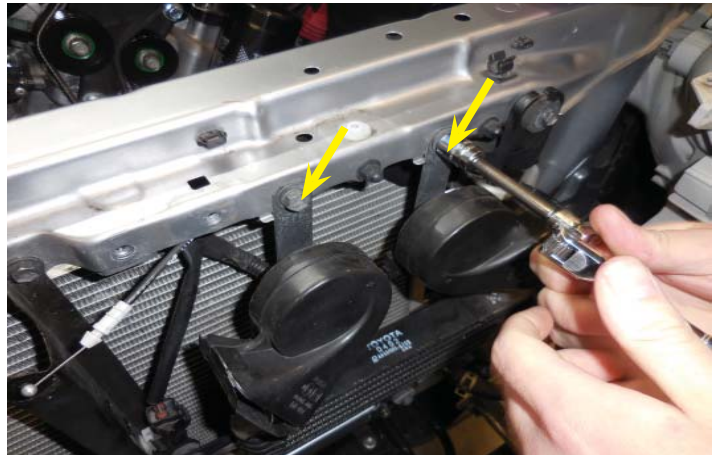

159. Unclip the temperature sensor from the hood support bracket.

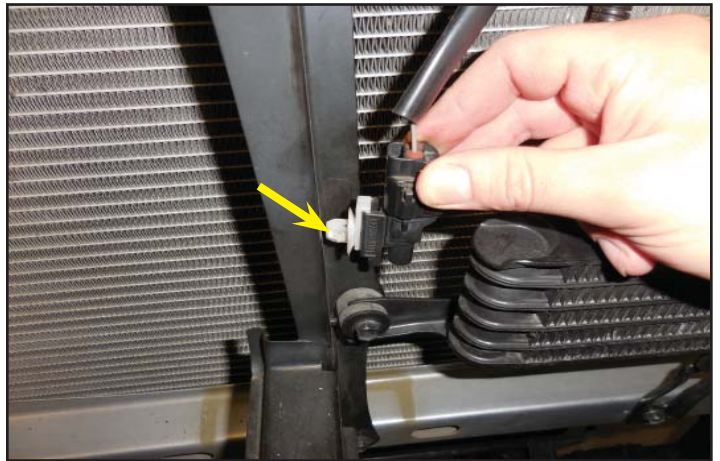

160. If the vehicle has a transmission oil cooler, remove the three mounting bolts. **Do not disconnect the fluid lines.**

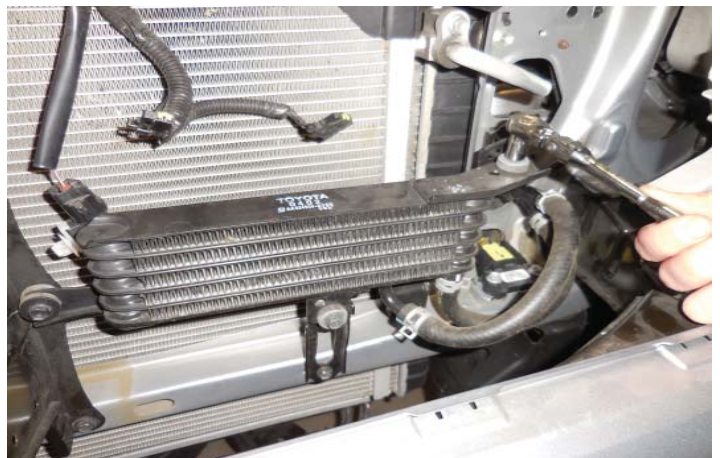

161. Temporarily swing the oil cooler out of the way.



162. Remove the 2 plastic retainers and the 2 nuts and bolts that attach the hood support bracket to the bumper cover and radiator support. You will have to remove a few plastic rivets (one shown with green arrow) on the bumper cover to get to one of the fasteners. Fasteners will vary depending on the year of your vehicle.

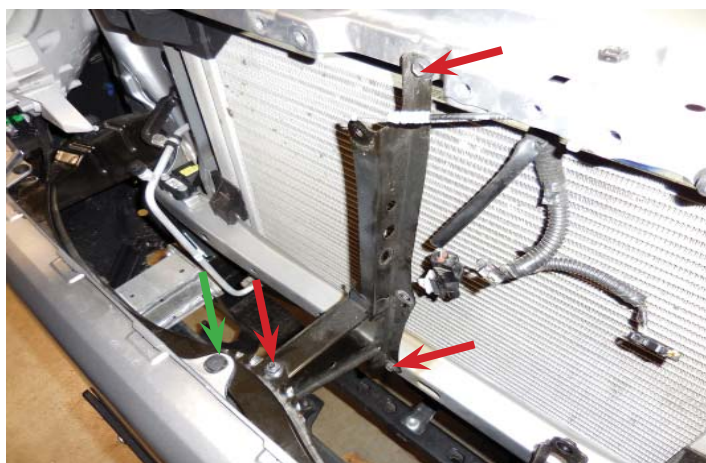

163. Here is another one of the rivets that you will have to remove to get to the nut under the bumper cover.



164. Here you can see the location of the hidden nut.



165. This photo shows the grill area with the hood support bracket removed.

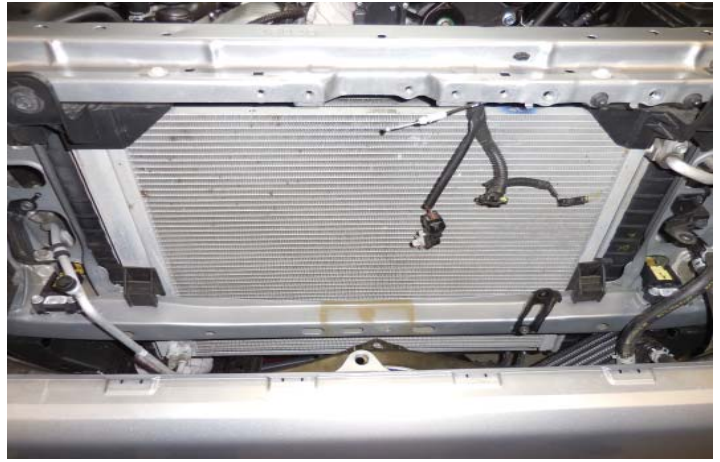

166. Remove the oval grommet from the hood support bracket and install the grommet into the new hood support bracket. Discard the original hood support bracket. **NOTE: For 2012-2015 MY discard the oval grommet as it is not required.**

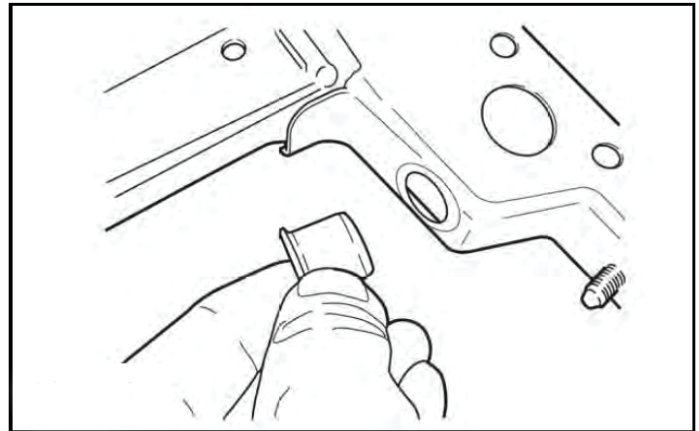

167. Gather the following provided part. There are two of these which will be attached to the supplied Low Temperature Radiator (LTR). You will have to remove the small protrusions in the two green highlighted areas shown with arrows on each of these rubber supports.



168. Place the 2 rubber grommets supplied in the kit into the brackets on the bottom of the LTR. Note the orientation of the grommets in the U-shaped brackets which have one leg shorter than the others.



169. Place the LTR in position by placing the rubber grommets on the bottom over the upright flange on the lower radiator support. The upper mounting tabs on the LTR align with the mounting locations for the hood lock lever release protector. Do not install the bolts on the top at this time.



170. Remove the 2 plastic plugs from the side of the LTR. The lower plug is shown.

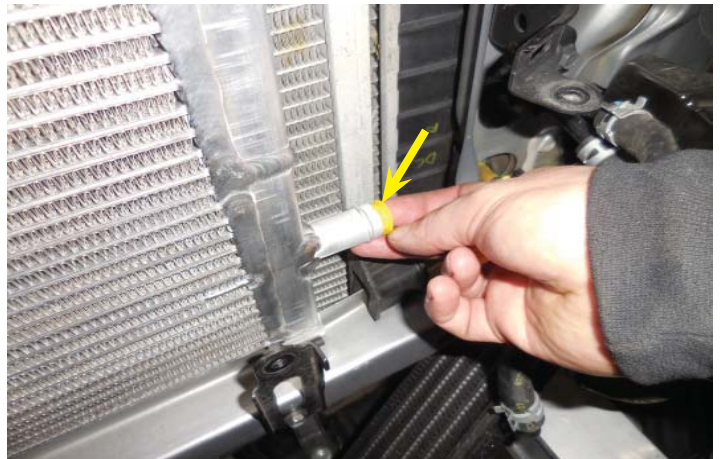

171. Mount the intercooler pump to the new hood support bracket using the two large #35 Adel Clamps and M6X16 Hex Flange Head Bolts. Do not tighten the fasteners at this time. HINT: It helps to hand shape the Adel Clamps to the shape of the pump.



172. For 2012 MY and newer Vehicles mount the Bracket to the new hood support bracket using the provided M6 Hex Nuts.



173. Install the new hood support bracket with the original fasteners.



174. Re-attach the hood release cable. Reinstall the hood lock assembly. Torque the bolts to **12 Nm (9 ft lbf)**.



175. Temporarily place the hood lock lever protector in place and mark where it needs to be trimmed to clear the new hood support bracket and LTR mounting tabs.



176. Remove and trim the protector as required in 3 places. This 2015 truck required 1/2" to be trimmed from the back side of the cover (Highlighted in green on this photo).



177. Reinstall the hood lock release lever protector with the original fasteners. Torque the hood release fasteners to **12 Nm (9 ft lbf)**. The wires for the horns need to be routed to the left of the LTR bracket. The temperature sensor wire needs to be routed between the 2 brackets. Re-attach the temperature sensor where shown with an arrow.

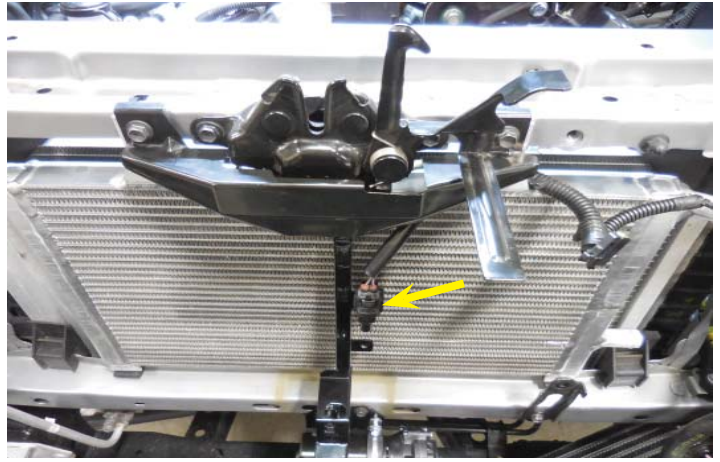

178. Ensure that the output on the pump is facing straight up, and tighten the two Adel clamps.



179. Slide a wide band spring clamp approximately 2" onto each end of the LTR to the pump formed coolant hose. Install this hose to the lower outlet on the LTR and the pump outlet and position each clamp to hold it in place. If the vehicle has a transmission oil cooler, cut and install a 4" long piece of 1" split wire loom on the coolant hose where shown.



180. **For 2005-2012 only.** If your vehicle has a transmission cooler, mount the inboard end to the new hood support bracket with the original fasteners. Torque to **5 Nm (44 in-lb)**. Remount the outboard end of the transmission oil cooler with the provided .75" thick spacer, 6 mm ID washer, and M6X50mm bolt. Note, this is to space the oil cooler out away from the LTR. Torque this M6 bolt to **5 Nm (44 in-lb)**.

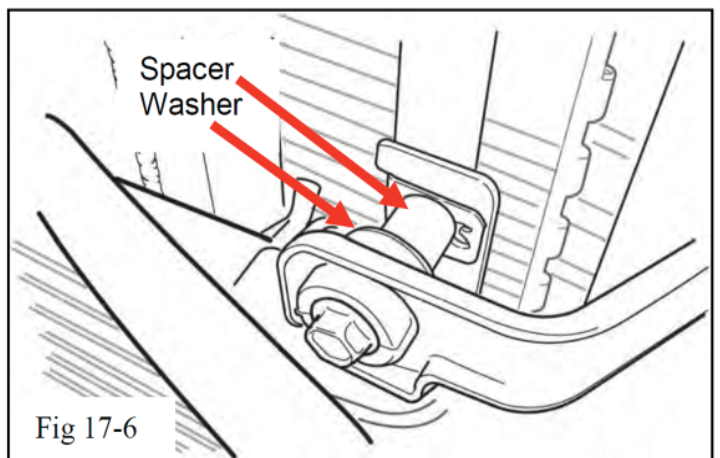

181. **For 2013-2015 only.** If you have a transmission oil cooler you will have to bend the tab over in the location shown to allow it to fit the new bracket.



182. **For 2013-2015 only.** Attach the transmission oil cooler in the original locations using the OEM bolts. You will have to loosen the lower bracket where it attaches to the cross beam to allow for proper alignment (shown with an arrow).



183. Reconnect the wires to the horns.



184. Use the supplied spacers and M8X30mm bolts to install the horns in the orientation shown.



Section 9: Intercooler Reservoir (With Vacuum Brake Booster)

185. If your vehicle is equipped with the Brake Vacuum Booster Cylinder (shown with a yellow arrow) continue with the following instructions for installing your intercooler reservoir and hoses. Otherwise follow the steps for "Alternate Intercooler Reservoir Location" (W/O Vacuum Brake Booster).



186. Take the 4" x 60" molded coolant hose and cut the long length to 42" (**FOR 2013-2015 TACOMA, CUT THE LONG LENGTH TO 34", NOT 42".**) Cut the short 4" leg to 2.5" from the outside edge as shown at the dashed line. Slide a wide band spring clamp approximately 2" on each end of this hose.

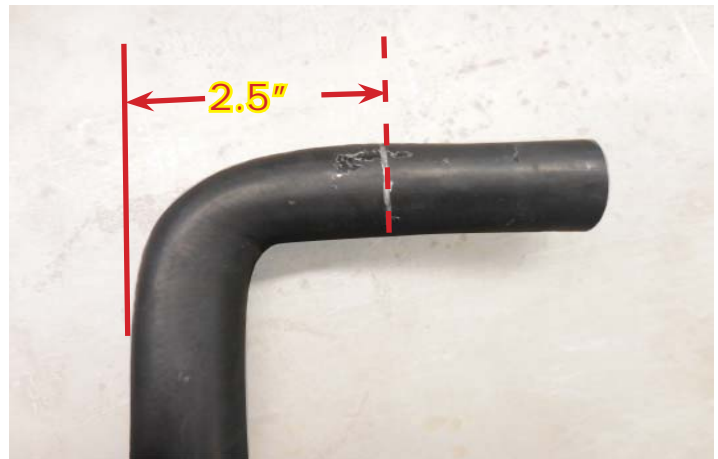

187. Cut a 42" length of 3/4" coolant hose, and add that to the hose from the last step with a hose mender and spring clamps (shown with arrows in the photo). Cut a 29" length of wire loom and slide that over the 42" length of hose you cut in this step, and locate it 4" from the end. Secure this wire loom with some electrical tape.



188. Slide the 42" hose section that was covered in wire loom in the last step behind the fuse box, battery, and headlight.



189. Here you can see the hose from the last step (highlighted in green) being routed behind the battery, and the headlight.



190. Continue routing the hose from the previous step to the upper LTR barb.



191. Secure the end of the hose from the last step to the upper LTR barb using a provided spring clamp.



192. Connect the opposite side of the hose from the last step to the right side intercooler fitting on the supercharger (shown with a yellow arrow) using a provided wide band spring clamp. The red arrow shows where the hose mender is located.



193. Cut a 54" length of the provided 3/4" hose, and cover it with a 29" length of provided wire loom. Center the wire loom on the hose and secure it with electrical tape. The hose is highlighted in green for clarity. From the front of the vehicle slide this section of hose behind the headlight, battery, and fuse box. This section of hose will go above the hose that attaches to the upper LTR barb.



194. Connect the hose from the last step with a provided wide band spring clamp to the input of the intercooler pump (shown with an arrow).



195. Here is the end of the hose (highlighted in green) from the last step at the point where it exits from behind the fuse box.



196. Gather the provided bracket, intercooler reservoir, and bolts and secure them together as shown.



197. Connect the reservoir bracket to the fender well with two provided bolts (shown with yellow arrows). Attach the hose from two steps ago to the front lower reservoir barb (shown with a red arrow) and secure it with a provided worm gear clamp. **It is important to only use worm gear clamps on the intercooler reservoir.**



198. Cut the short end of the 4" x 36" 90° molded hose to the same 2.5" length from the outside edge like you did with the 4" x 60" hose. Attach the side with the bend to the left side intercooler fitting on the supercharger (shown with a yellow arrow) using a provided wide band spring clamp. Run the opposite end to the upper back hose barb on the intercooler reservoir, (shown with a blue arrow) and trim the length to fit. Secure the hose to the intercooler reservoir with a provided worm gear clamp. The red arrow shows the hose connection made on the previous step with a worm gear clamp.



199. Using the small Adel clamp and a M6X12 bolt, secure the two coolant hoses to the boss on the rear of the supercharger housing.



200. Cover the two hoses that are near the brake booster with 6.5" of wire loom as shown. Ensure that the hoses do not get close to the brake reservoir.



Section 10: Intercooler Reservoir (W/O Vacuum Brake Booster)

201. There are 2 holes in the lifting bracket for the brake master cylinder. They will be used to mount the intercooler coolant reservoir. The forward most of the two holes has an M6 weld nut attached to the lifting bracket.

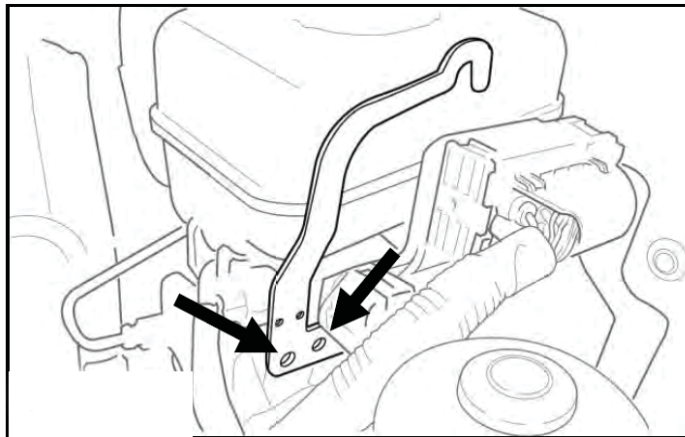

202. Using 2 M6x20 bolts and 1 M6 nut, mount the intercooler reservoir bracket to the 2 holes in the lifting bracket. Torque: **5.5 Nm (49 in lbf)**.

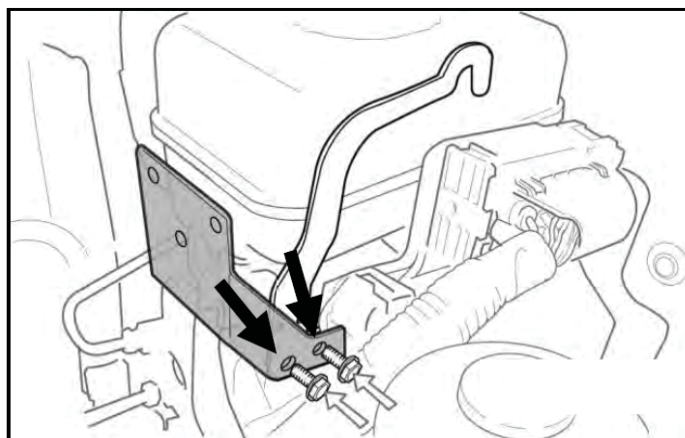

203. Using the 3 provided M6x12 bolts, mount the intercooler reservoir tank to the reservoir bracket. **Torque the 3 M6x12 bolts to 4 Nm (35 in lbf)**. Take the 96" length of 3/4" coolant hose and cut it into 47.25", 6.75" and 42" length. Slide one 29" length of wire loom onto the 47.25" length of 3/4" coolant hose and center it. Slide a wide band spring clamp approximately 2" onto one end of the 3/4" hose and a screw clamp onto the other end. Attach the 90° hose mender at the screw clamp end of the 47.25" hose. Attach the 6.75" hose to the other end of the 90° hose mender with a wide band clamp.

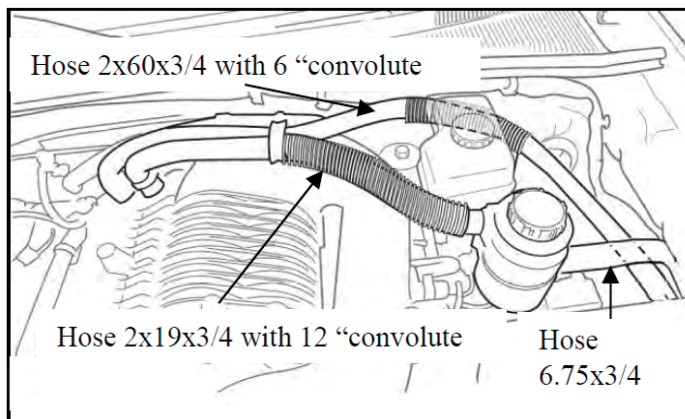

204. Route the hose assembly from the last step with the elbow end at the coolant reservoir outlet (Bottom barb on the reservoir bottle) under the wiring harness between the fuse panel and fender, and through the opening behind the headlight assembly. Connect the other end of the hose to the intercooler pump inlet. Position the wide band spring clamp to secure the hose to the intercooler pump inlet and tighten the screw clamp at the reservoir outlet. Finally, position the 1" wire loom so it protects the hose where it runs through the bulkhead behind the headlights.

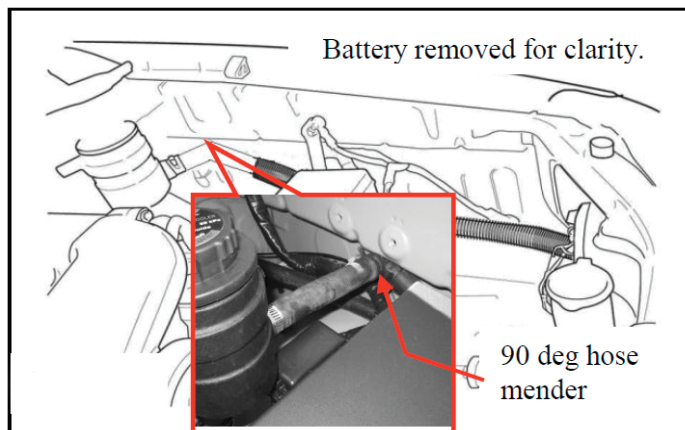

205. Take the remaining 29" piece of 1" wire loom and slide it onto the remaining 42" piece of 3/4" hose and center it for now. Slide a wide band spring clamp on each end. Insert the 3/4" hose mender fitting (shown with an arrow) in one end and secure it with the wide band spring clamp.



206. Take the 4" x 60" molded coolant hose and cut the short 4" leg as shown at the dashed line. Slide a wide band spring clamp approximately 2" on each end of this hose. Connect the long straight section of this hose to the other end of the hose mender from the previous step and secure it with the clamp.

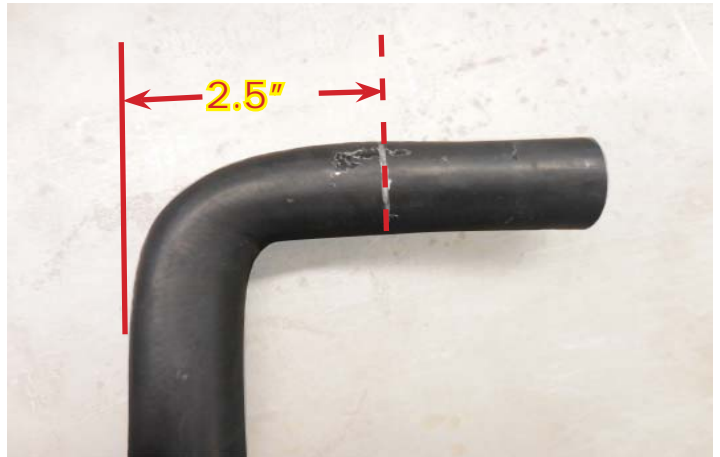

207. Install the short leg of the molded hose end to the right side intercooler fitting on the supercharger housing top cover. Secure it with the wide band spring clamp.

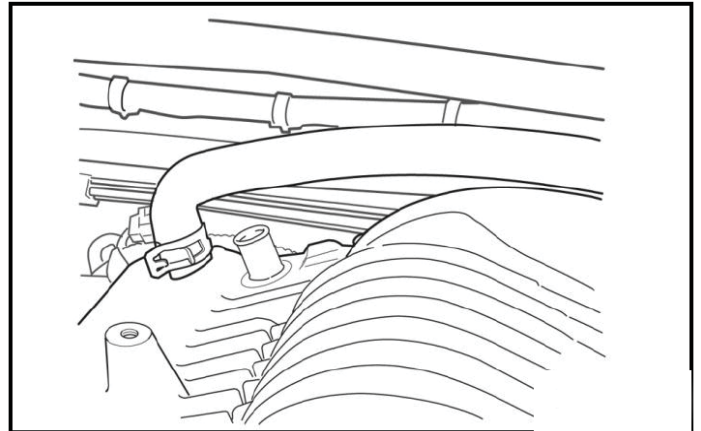

208. Route the hose across the firewall, behind the brake fluid reservoir, down along the engine compartment, then alongside the hose installed earlier, on through the bulkhead opening behind the headlight assembly, and connect it to the upper barb on the LTR and secure it with the wide band spring clamp.

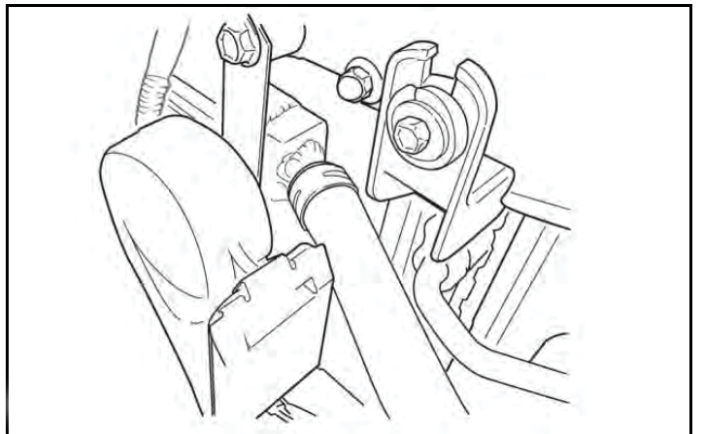

209. Trim the short end of the 4" x 36" molded hose as shown at the dashed line. Slide a wide band spring clamp approximately 2" onto the short leg of the 3/4" hose and a screw clamp onto the other end.

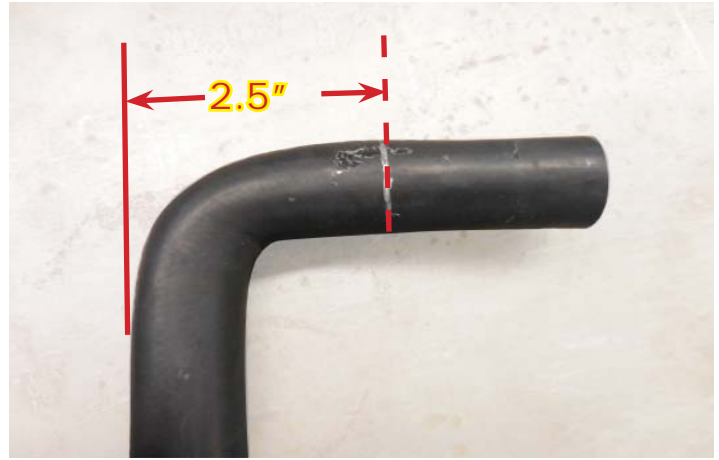

210. Attach the short leg of the molded hose end to the side intercooler fitting on the supercharger housing top cover. Secure it with the wide band spring clamp.

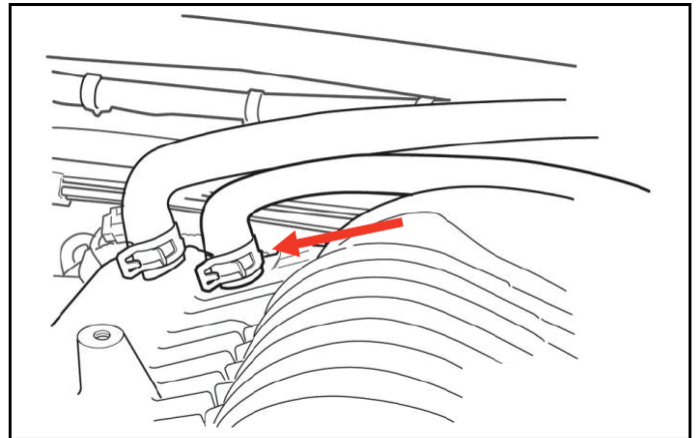

211. Run the hose along the earlier hose in front of the brake fluid reservoir, trim the remaining end as necessary, and install it on the inlet barb of the intercooler reservoir with the screw clamp. Cut the 18" piece of 1" wire loom into two pieces of 6" and 12" lengths. Place them on the inlet and outlet cooler hoses as shown. The 6" length is placed behind the brake fluid reservoir, and 12" length attaches close to the reservoir.

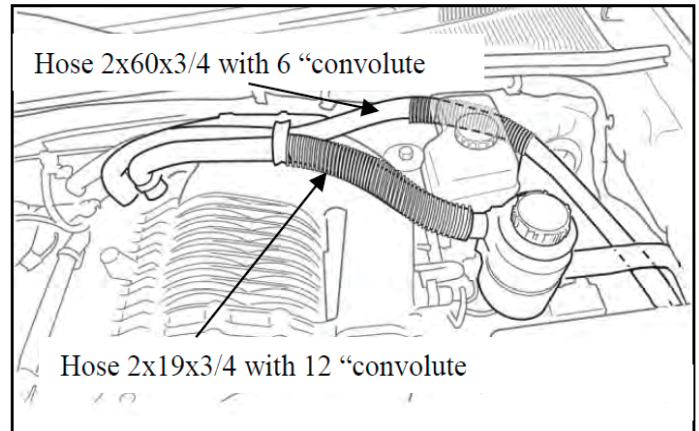

212. Using the small provided Adel clamp and a M6X12 bolt, secure the two coolant hoses to the boss on the rear of the supercharger housing.



Section 11: Intercooler Pump Wiring Connections

213. On the left side of the radiator you will find a hole in the factory sheet metal (shown with an arrow) for mounting the intercooler pump relay. You may have to move some factory components to make room for the relay in the next step.



214. Using the supplied M6x20 bolt and hex nut, mount the intercooler relay harness on the rear of the radiator support bulkhead using an existing open hole. **NOTE: If the bolt diameter is slightly larger than the hole in the relay, you can either drill out the hole in the relay with a 6 mm drill or just screw the bolt into the relay mounting hole.**



215. Install 15 amp ATO fuse into the fuse holder.



216. Place the cover on the fuse holder. Remove the bolt at the location shown with the arrow near the battery. Use the bolt to secure the fuse holder in the bolt's original location.

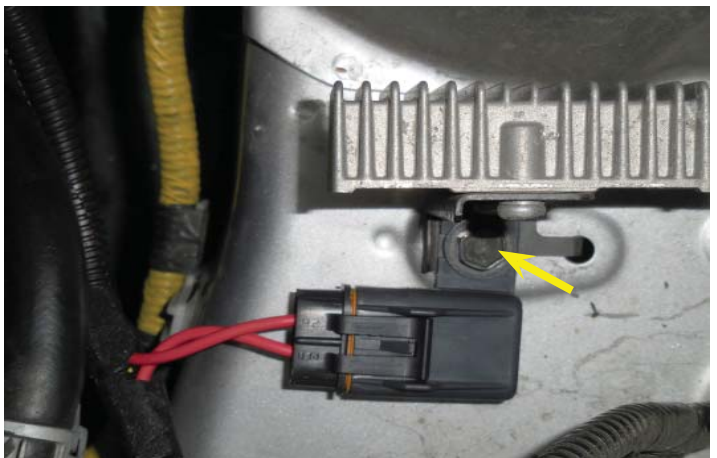

217. Remove the bolt retaining the vehicle ground wire to the fender, route the ground wire from the intercooler pump relay between the battery and the fuse box and install it over the vehicle ground wire and reinstall the bolt.

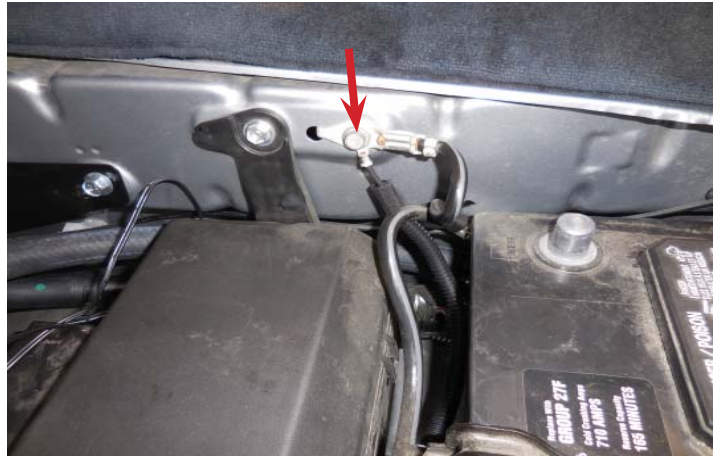

218. Route the wire harness containing the 10 gauge red wire and the yellow wire along the right side of the fuse panel from the fender to the inside of the fuse box (highlighted in green). Feed both wires up into the fuse box through the same opening used by the vehicle wiring harness. Remove the nut that is on the B (+) connection in the fuse box (shown with an arrow). Connect the 8mm ring terminal from the intercooler relay to the B (+) terminal in the fuse box.



219. Remove the 10-amp mini fuse labeled EFI No. 2. (shown with an arrow)



220. Here is a photo of the provided fuse (on the left) and the OEM fuse.

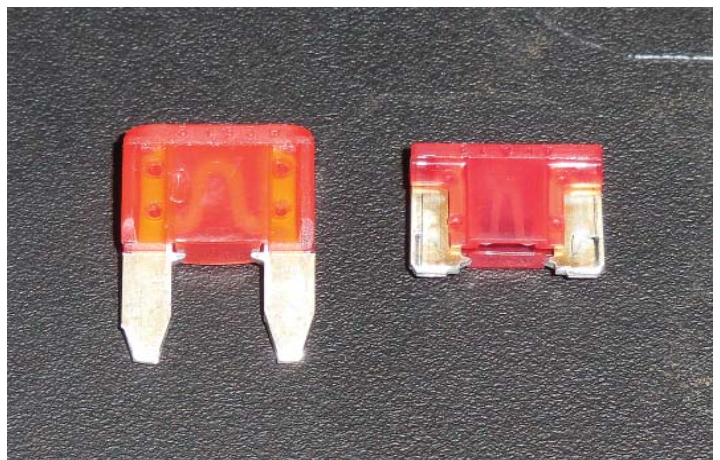

221. Install the T-tap on the new 10 amp mini fuse supplied with the kit.

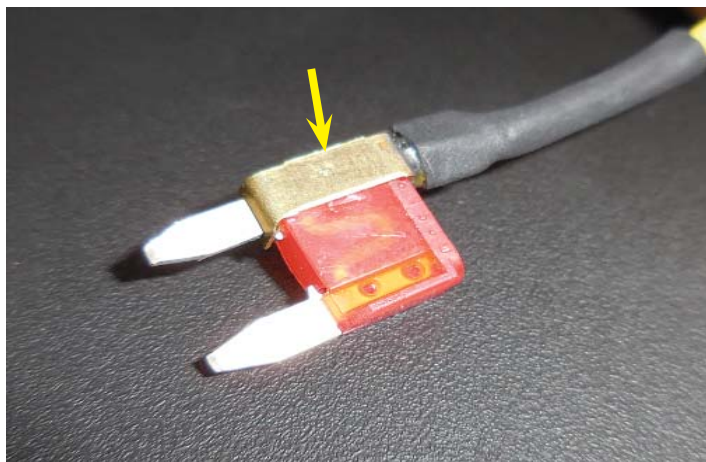

222. Install the new 10 amp mini fuse with the T-tap yellow wire back in the same EFI location. Route the wire along the pathway shown in the image. **CAUTION: When installing the fuse, make sure the tap is toward the rear of the vehicle.**

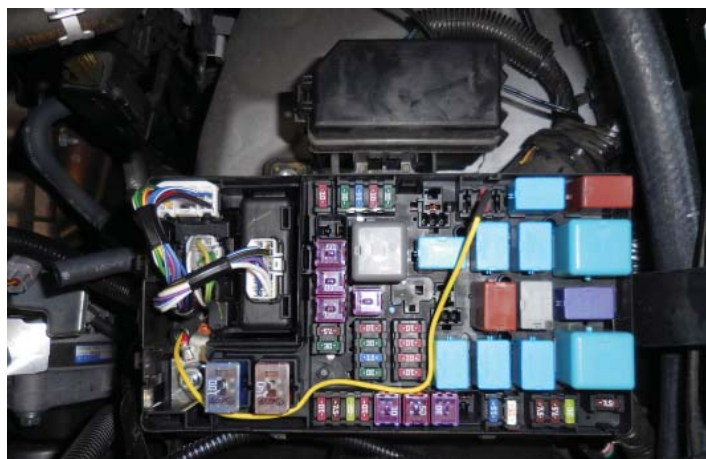

223. Remove the small 1/8" x 3/4" section of plastic highlighted in yellow on this image. This will allow clearance for the yellow wire when the lid is installed.



224. Install the lid back onto the fuse box.



225. Route the two wire connector through the opening in the radiator support bulkhead. Run the wire along the hose going to intercooler pump input (shown highlighted in green). Secure with two cable ties (shown with arrows).

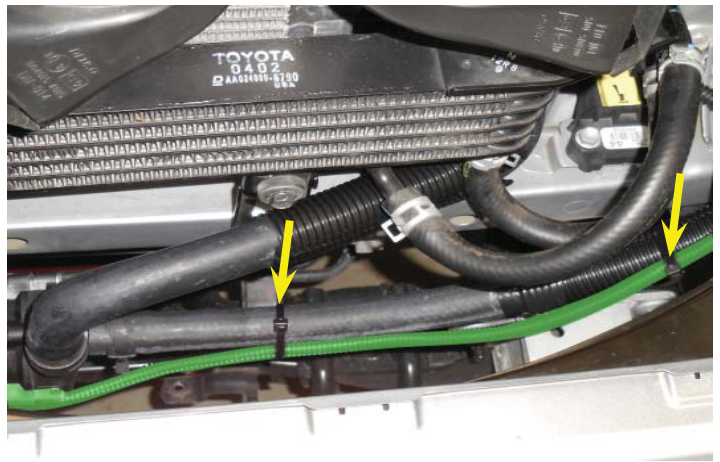

226. Continue to route the wire along the underside of the intercooler pump, and plug it into the connector on the intercooler pump. Secure the wire in place with two more cable ties in the locations shown with arrows.



Section 12: Vacuum Hose and Air Cleaner Installation

227. Remove the VSV from the left rear side of the original intake manifold (surge tank). Keep the VSV and bolt for the next steps. The hose will be used later as well.



228. Trim the tab (highlighted in green) off the VSV. Some VSV units will look slightly different and may not require this modification.



229. Mount the VSV to the supplied bracket. You may have to bend the bracket slightly to gain more clearance for the hoses and electrical connections. For this 2015 application we bent the bracket from 120° to 105°. Mount this sub-assembly to the front stud of the oil filler cap housing. Remove the stock nut, install the M6 washer, the bracket-valve assembly, and reinstall the nut. Torque the nut to **9 Nm (80 in lbf)**.

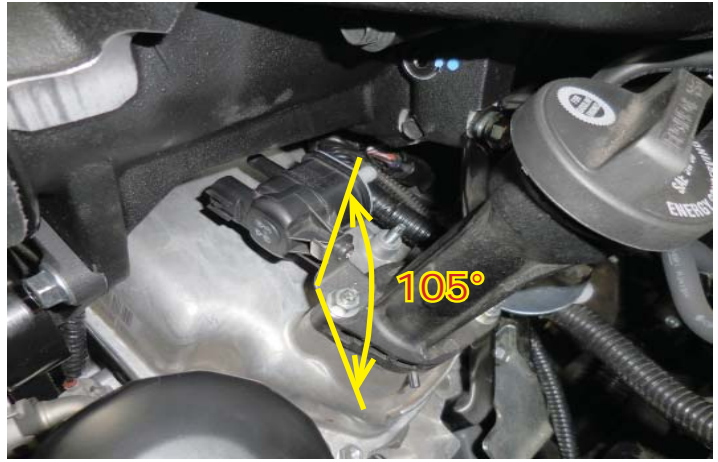

230. Reconnect the hose that was removed from the VSV a few steps ago. Note: the VSV is shown removed from the vehicle for clarity.

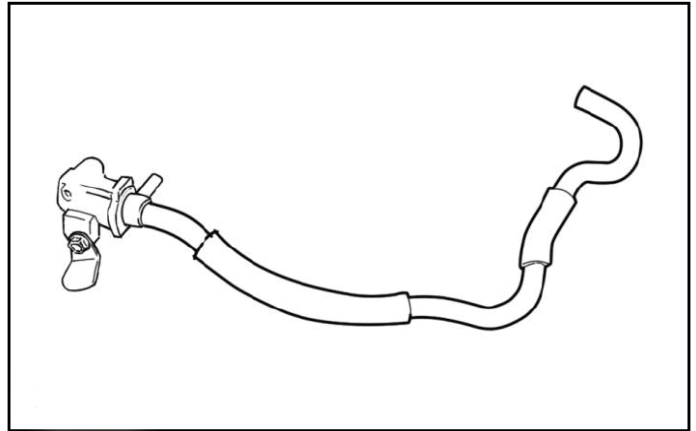

231. Connect the opposite end of the hose from the last step to the hose barb shown with the red arrow. Connect the power brake booster hose onto the supercharger housing using the forward 3/8" barb (shown with a yellow arrow).



232. If your vehicle does not have a brake booster hose you will have to remove the cap shown with the arrow from the previously removed air surge tank and install it on the forward 3/8" barb on the supercharger housing.

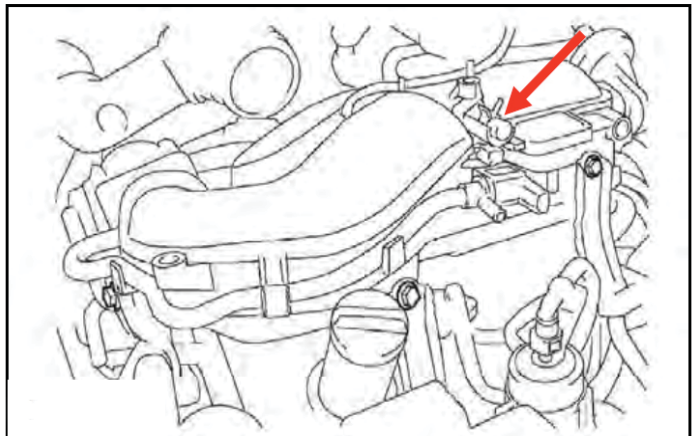

233. Plug in the electrical connector to the VSV shown with a red arrow. Plug the supplied 5/16" hose (highlighted in green) to the VSV connection shown with the yellow arrow using an OEM spring clamp and route it back around to the left side of the engine.



234. Connect the 5/16" hose (highlighted in green) from the last step to the EVAP canister using the OEM clamp shown with an arrow.



235. Finally, connect the ventilation hose that was disconnected when removing the air surge tank to the 3/8" barb that is on the bottom of the supercharger housing (shown with an arrow).



236. Plug in the throttle control connection.

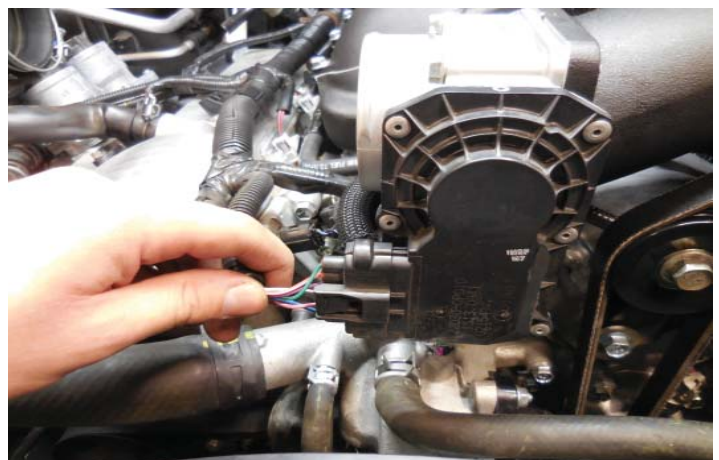

237. Using a provided M6x16 bolt, install the air box bracket to the right side valve cover finger tight.



238. Release the four clamps holding the air box lid.



239. Replace the OEM filter (on the left) with the provided filter. Secure the lid with the four clamps.



240. Replace the air cleaner assembly in the original location. One fastener location has changed.

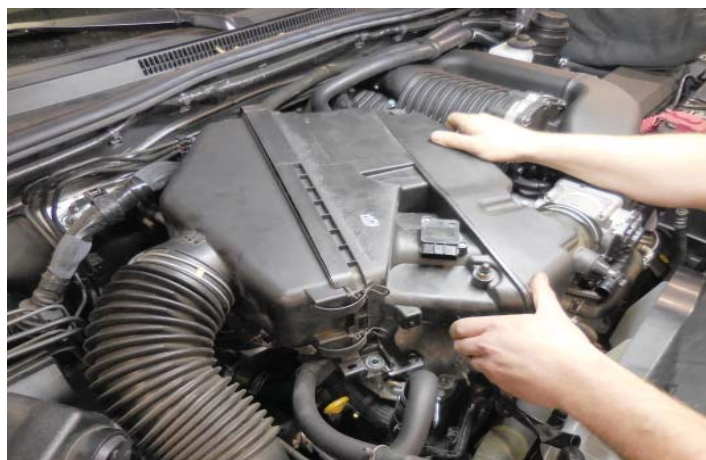

241. Gather the two OEM air cleaner assembly fasteners shown.



242. Install one of the two fasteners in the last step to the location shown with the yellow arrow. Connect and tighten the two hose clamps shown with green arrows. Plug in the MAF meter shown with the red arrow. Also connect the No. 2 ventilation hose shown with a blue arrow.

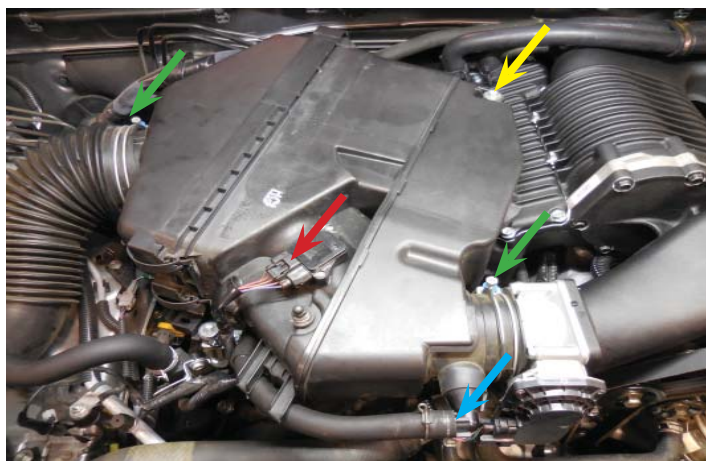

243. The other OEM fastener from two steps ago and a provided M6 nut will be located at the provided air box bracket which was installed on the right side valve cover. After this fastener has been tightened you will have to tighten the bolt holding the bracket on the valve cover. Also reconnect the 2 wire harness clamps that were located in this area.



244. Connect the vacuum hose that is highlighted in green to the back of the air box assembly.

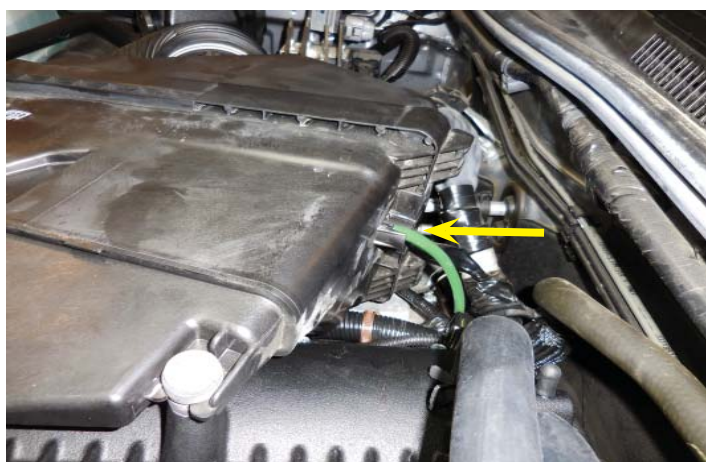

245. If you have a manual transmission you will need to install a 4" length of ½" convoluted tubing on the clutch hydraulic line shown.



Section 13: Coolant Fill and Vehicle Testing

246. Ensure that the drain plug for the radiator is closed. Filter the saved coolant that was drained from the radiator earlier, and use that to re-fill the radiator. If you run out of coolant continue to top off with a Toyota approved coolant mixture. Check the coolant level inside the radiator by squeezing the inlet and outlet radiator hoses several times by hand. If the coolant level goes down, add coolant. Install the radiator cap. Slowly pour coolant into the radiator reservoir (shown with a yellow arrow) until it reaches the FULL line. Reinstall the cap to the radiator and the radiator reservoir.



247. Reconnect the negative lead of the battery.

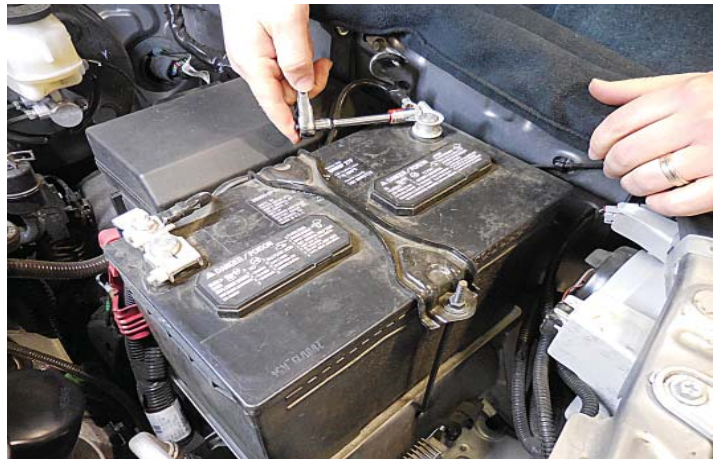

248. Fill the intercooler reservoir with a Toyota approved coolant mixture until it is full. Have someone else cycle your ignition switch to the accessory mode to trigger the pump on. **Do not start the vehicle!** This will circulate the fluid. Once the reservoir drains turn the pump off, and fill it again. **Do not allow the reservoir to run dry.** Check for fluid leaks. Also check for fuel leaks at this time. Repeat until full circulation is achieved with a full reservoir. Fluid level should be just above the top barb. Re-install the reservoir cap.



249. Check the belts to see that they are properly aligned on all the pulleys. Start the engine and let it idle. Check for fuel, and coolant leaks. Squeeze the inlet and outlet hose on the radiator to remove trapped air from the system. Check the air intake for leaks, and tighten any loose fittings. Shut down the engine, and allow it to cool.



250. Once the engine has cooled down check the level of the radiator reservoir, and the intercooler reservoir. Add coolant if necessary. Reinstall the grill.



251. Reinstall the radiator cover with the 9 plastic rivets.



252. Test drive the vehicle for the first few miles under normal driving conditions. **Do not perform any wide open throttle runs.** Check for any unusual sounds, vibrations, or engine misfires. The supercharger does have a slight whining noise under boost conditions, which is normal. After the initial test let the engine cool down, and recheck coolant levels.



253. After the initial test drive gradually work the vehicle to wide open throttle runs. Listen for any engine detonation (pinging). If engine detonation is detected let up on the throttle immediately. Most detonation is caused by low octane gasoline still in the tank. Premium 91 octane fuel is required. Enjoy your new supercharger.

If you have questions about your vehicles performance, please check with your installation facility.

After you finish your installation and road test your vehicle, please fill out the warranty registration. This can be found on our website.



Diagrams

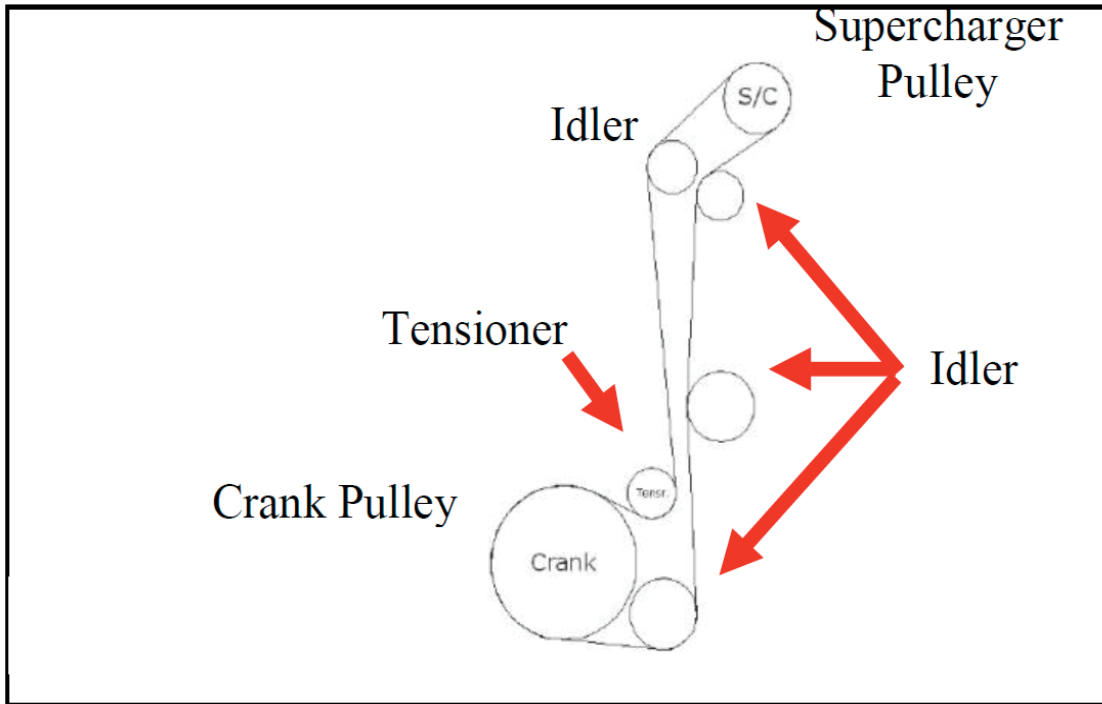

Belt Routing Diagram

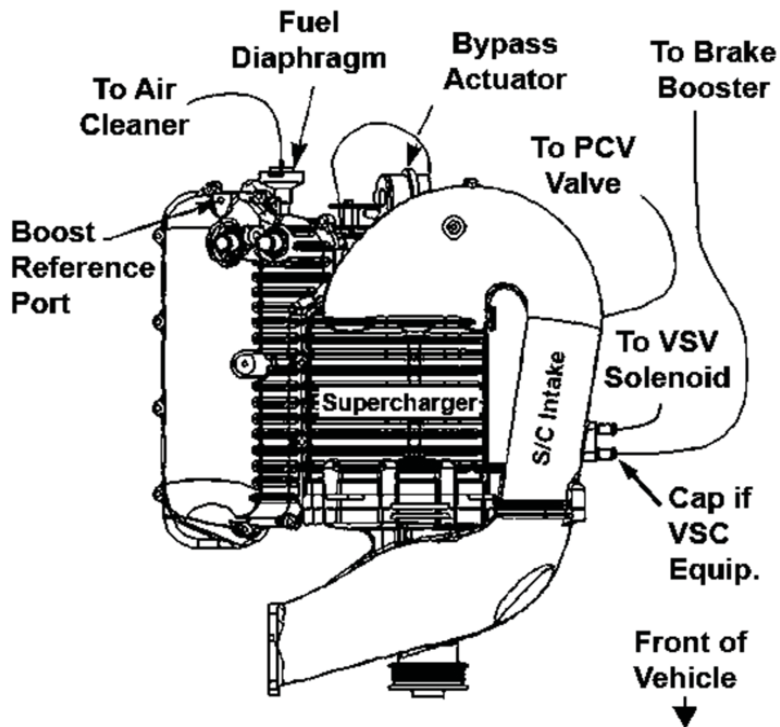

Vacuum Routing

Notes

Notes



Please enjoy your "Magnuson SuperCharged"
performance responsibly.

Use only premium gasoline fuel, 91 octane or better.

MAGNUSON
SUPERCHARGERS



Toyota Tacoma/FJ 4.0L Bully Dog GT Instructions

1. Install the "Update Agent" on your personal computer. You can download this software at: www.bullydog.com/update_agent.php (You will need this software in a later step.)
2. Attach a battery charger to your vehicle's battery.
3. Install the micro SD card into the Bully Dog GT handheld unit.
4. Plug the HDMI cable into the adapter for your OBDII port. Ensure that the adapter is set to the "BATT" position. Then plug the OBDII connector into the vehicle's OBDII port.
5. If you receive an error code regarding "GTUMENU" your SD card file will need adjustment. Disconnect the Bully Dog GT from the OBDII port. Remove the micro SD card from the Bully Dog GT. Install the micro SD card in the included USB adapter, plug it into a computer and rename the "GTUMMENU.GTG" file to "GTUMENU.GTG". Reinstall the microSD in the Bully Dog GT, connect it to the OBDII port on your vehicle again and proceed to the next step.
6. Turn the vehicle key into the "On" position. **Do not start the engine.**
7. Allow the Bully Dog GT unit to initialize. When you see the screen with "Menu" in the upper left corner press the top left button to enter the Main Menu screen.
8. You will see the "Welcome to the Gauge Tuner" screen where you will be prompted to insert your micro SD card. Press the arrow up key to continue.
9. Choose your vehicle make, transmission type, model (**Make sure to choose the SC for supercharged if available**), engine, and year. If your year is newer than any listed choose the one closest.
10. Once you have properly entered the information from the last step choose "yes".
11. On the Main Menu screen press the button next to "Install Download".
12. You will now see a "Caution" screen. Verify the vehicle type. If it matches the information you selected in step #8 select "yes" using the upper right button. If not you will have to go back to the Main Menu to choose the proper vehicle.
13. Next you will see the "Disclaimer" screen. Read the disclaimer by arrowing down with the right lower button to see more. Now you will have to press the button next to "Agree" to continue with the install.
14. The next screen will show you the "Download Requirements". Read this over by pressing the right lower button. You will then have to press the button next to "Continue".
15. Now you will see the "Key Cycles Disclaimer" screen. Read all the text as you press the right lower button. Once you have read everything press the button next to "Continue".
16. The "Battery Charger" screen will appear. Read this through to confirm that the proper 10 Amp minimum battery charger has been connected to your battery. Press the button next to "Connected" to confirm you do have a battery charger connected.
17. The "Loading Instructions File" will be displayed next. Wait until the gauge below shows 100% loaded.
18. The "Key Run" screen will display. Follow the instructions on the screen. Once you have key in the RUN position you can press the button next to "Continue".
19. "Battery Level" screen will display. If it is above 12.1 V you can proceed.
20. This will be followed by a "Please Wait" screen.
21. You will be prompted to turn the "Key Off" once the process is done. Then press "Continue".

(Continued on other side)

22. "Tune Selection" screen will display. Follow the directions on this screen by pressing down on the right lower button. Then press the button next to "Continue".
23. "Power Level" screen will display. Press the button next to "Stock". Then press the top button to Enter. ***Manual transmission vehicles will require you to select "Premium" on this step only.**
24. "Shift Points" screen will display. Press the button next to "Performance". Then press the top button to Enter. ***Manual transmission vehicles will not display this screen.**
25. "Tuning" screen will display. Tune A will be Set as a selected tune. The screen will display "You have already selected 1 of 3 Do you want to select another tune? Press the button next to "NO" on the right.
26. "Code 550" screen will display. This will prompt you to download the selected tunes from the Bully Dog server. You will download the tunes to the micro SD card with the "Update Agent" software that you loaded on your personal computer in the first step.
27. Unplug the Bully Dog GT handheld unit, and remove the micro SD card. Install this card into the micro SD card reader that is provided with the Bully Dog GT kit.
28. Plug the micro SD card reader with the micro SD card installed into the USB port of your personal computer.
29. Start the "Update Agent" software, and select the device to update.
30. Press "Start" to begin download process.
31. Once the "Update Agent" has completed a "Download Finished" window will open and prompt you to return to your vehicle with the micro SD card to "Install Download".
32. Install the micro SD card back into the Bully Dog GT handheld.
33. Connect the Bully Dog GT handheld back to the OBDII port as you did in step #4
34. Key the vehicle to the "On" position. **Again Do Not start the vehicle.**
35. Navigate to the "Main Menu" screen and select "Install Download".
36. "Caution" screen will display. Verify the type of vehicle is the same as what you selected in step #8. If so press the key next to "Yes".
37. You will have to navigate through the "Disclaimer", "Download Requirements", "Key Cycles Disclaimer", and "Battery Charger" screens before loading begins.
38. "Loading Instructions File" screen will display next. Wait for the file to be loaded.
39. "Key Run" screen will display. Follow the directions on this screen. **Do Not start the vehicle.**
40. "Battery Level" screen will display followed by the "Please Wait" screen. Wait until the "Key Off" screen displays, and then follow the directions given.
41. "Tuning" screen will display next. Your VIN# will be displayed with two options to the left. Press the button next to "Continue with selected tunes?"
42. "Tune Selection" screen will display. Press the button next to "More" followed by the button next to "Continue" to get to the "Tune" screen.
43. "Tune" screen will display. Press the button next to "Stock". Press button next to Enter.
44. A verification screen will display next to confirm the proper options have been selected.
45. "Updating Files" screen will display. Wait until you are prompted to turn the key to the run position.
46. "Key Run" screen will display next. Follow the directions on the screen. **Do Not start the vehicle**
47. "Please Wait" screen will display followed by a "WARNING" screen. Once you read the warning screen press the button next to "Continue".
48. "Battery Level" screen will display.
49. "Downloading" screen will display. This will take some time to download multiple parts.
50. "Download Finished" screen will finally display. This will let you know that your download has been completed. Follow the on screen directions to turn the key off and click continue to finish.