

CafeRomantica

Automatic coffee and espresso machine
User manual and recommendations for use

NICR9..

GB



NIVONA

a passion for coffee.

1



G

F

C

A

B

E

P

O

S

H

N

D

M

J

K

L

T

Q

U

R

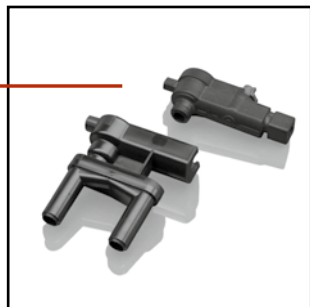

A Display and touch screen with main beverages menu

B Rotary

C Settings symbol

D Maintenance symbol

E Height-adjustable outlet

F Water tank cover

G Bean container cover

H On/off button

J Cup stand

K Service door handle

L Service door

M Ground coffee chamber lid

N Drip pan

O Used coffee tray (interior)

P Cover plate

Q Rear wheels (back)

R Milk frother individual parts

S Type label (remove drip pan)

T Cable compartment (back)

U MilkContainer

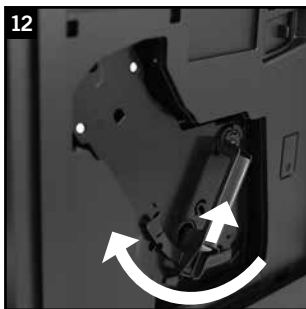
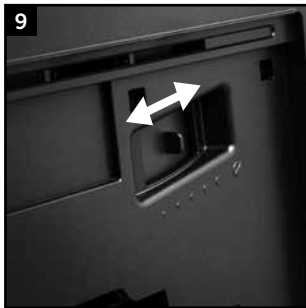





Dear customer,

Congratulations and many thanks for choosing a quality product from NIVONA.

To enjoy your NIVONA appliance fully, please read these instructions prior to use and take note of the safety information prior to initial set-up.

Please keep these instructions in a safe place so you can use them as reference and pass them on to any future users of the appliance.

These symbols are used frequently in these instructions and have the following meaning:

-  **Warning: This symbol indicates possible risks.**
-  **Information: This symbol makes you aware of features.**
-  **Tip: This symbol indicates additional tips.**
-  **Warning: Risk of burns!**

You can obtain an application (app) in the Apple App Store or Google Play Store for your NIVONA fully automatic coffee machine, which allows you to control and operate the main functions of your coffee machine. The "BLUETOOTH" menu item allows you to enable or disable a connection between your device and smartphone (see section 4.9.).

Your retailer and the NIVONA team hope that you enjoy great coffee and are extremely satisfied with this high-quality NIVONA product.

Bought at

Place, date

1. SAFETY INFORMATION	67
2. SET-UP	68
2.1. Preparation	68
2.2. Initial start-up	69
2.3. Key control elements and basic functions	70
2.4. Turning on the appliance during operation	72
2.5. ECO mode.....	72
3. PREPARING COFFEE SPECIALITIES	72
3.1. How to operate	72
3.2. Beverages <u>without</u> milk (espresso, coffee, caffè americano)	73
3.3. Beverages <u>with</u> milk (CAPPUCCINO, CAFFÈ LATTE, LATTE MACCHIATO, MILK/MILK FROTH)	74
3.4. Hot water (e.g. for tea)	76
3.5. Setting “My coffee” for me and others according to taste	77
3.6. Set grinding degree.....	78
3.7. Prepare ground coffee (e.g. decaffeinated coffee)	78
4. SET/CHANGE BASIC SETTINGS	78
4.1. Live programming beverage recipes	79
4.2. Times	80
4.3. Comfort settings	81
4.4. Set operation with or without a filter	81
4.5. Set water hardness	82
4.6. Set language	82
4.7. Request statistics	82
4.8. Factory settings	82
4.9. Bluetooth.....	83
5. CLEANING AND MAINTENANCE	83
5.1. Rinse frother	83
5.2. Rinse the system	84
5.3. Clean the milk frother	84
5.4. Clean the system	84
5.5. Remove and clean the brewing unit	84
5.6. Descale system.....	85
5.7. Regular cleaning by hand	85
5.8. Change filter	86
5.9. Maintenance status.....	86
6. SYSTEM NOTIFICATIONS	87
7. TROUBLESHOOTING	88
8. SPARE PARTS/ACCESSORIES	89
9. CUSTOMER SERVICE, GUARANTEE, ENVIRONMENTAL PROTECTION	89
10. TECHNICAL DATA	90

1. Safety information

- The appliance must be used for the intended purpose only (domestic use only) and is not intended for commercial use (see guarantee conditions). Otherwise, claims under the guarantee will not be accepted.
- Operating voltage must correspond to the mains voltage. Please see the type label/sticker on the appliance (see figure 1/S).
- Do not use the appliance if the power cable or casing is damaged. Do not bring the power cable into contact with hot parts.
- The appliance must not be operated at altitudes greater than 2,000 m above sea level.
- Do not unplug the mains plug by pulling on the power cable.
- Follow the cleaning and descaling information strictly. Non-compliance will void any guarantee claims.
- Ensure that the appliance is turned off and the mains plug is unplugged prior to maintenance and cleaning.
- Never allow the mains plug to get wet and protect it from moisture.
- Put the appliance on an even, stable surface and use inside only. Never put the appliance on hot surfaces or near flames.
- The device must not be operated in cupboards or enclosed items of furniture.
- This device may be used by **children** aged 8 years and over and by individuals with reduced physical, sensory or mental abilities or limited experience and knowledge, if they are supervised and instructed regarding safe use of the device and if they understand the resulting risks. **Children** must not play with the device. Cleaning and **maintenance** by the user must not be carried out by **children** unless they are 8 years old or older and are supervised. The device and its connection cable must be kept away from children under 8 years of age.
- Please unplug the mains plug during extended absences lasting several days.
- Do not leave the appliance switched on unnecessarily. Do not submerge the appliance in water.
- Never clean the appliance or individual appliance parts in the dishwasher. Non-compliance will void any guarantee claims.
- Immediately unplug the mains plug in the event of a malfunction (never pull on the power cable or appliance itself).

- Liability for any damages that may occur will not be accepted in the event of incorrect operation, improper use or if the device is repaired by unauthorised persons. This will invalidate the warranty.
- Please use the integrated coffee grinder to grind roasted and untreated coffee beans only – not any other food! Always ensure that there are no foreign objects among the coffee beans – otherwise, claims under the guarantee will not be accepted.
- If repairs are required (including replacing the power cable!), please contact the service hotline or the retailer where you bought the appliance in the first instance, and send the appliance to **NIVONA Zentralkundendienst, Südwestpark 49, D-90449 Nürnberg, Germany**, following consultation and in due consideration of section 9 of this user manual.
- If the power cable is damaged, it must be replaced by the manufacturer, its customer service team or a similarly qualified professional to prevent risks.

⚠ Warning: Repairs to electrical appliances must be carried out by professionals only! Incorrect repairs may lead to serious risks for the user. If the appliance is misused or operated or maintained incorrectly, no liability will be accepted for any damage that may occur.

⚠ Warning: Operating the On/Off switch (figure 1/J) during brewing can damage the appliance! Only switch it off when the appliance is in standby mode.

⚠ Warning: Risk of burns! While obtaining steam or hot water, hot water may spray out of the outlet initially. Only touch the outlet once it has cooled down.

2. Set-up

2.1. Preparation

→ Carefully remove the appliance and all supplied parts from the packaging.

The following parts are supplied (figure 2):

- User manual
- Guarantee card
- Measuring spoon with installation aid for filter cartridge
- Two cleaning tablets
- Claris filter
- Water hardness test strip
- MilkContainer with connection tube (figure 5)

i Information: The appliance should be sent by post in its complete original packaging if customer support service is required. Therefore please retain the packaging in full including any polystyrene parts.

→ Place the appliance on an even, dry and appropriate work surface.

- Connect it to a professionally installed socket.
- Your appliance has a cable compartment - if the lead is too long, you can push any cable length which is not required into the compartment on the back (figure 1/T).

2.2. Initial start-up

→ Turn the appliance on with the On/Off button (figure 1/H).

After a short time, the initial start-up screen will appear where you will need to select a language.

i Information: Please follow the instructions on the display. You will be guided through the initial start-up menu step-by-step.

Step 1 Language:

→ Turn the rotary (figure 1/B) to the language required and press the rotary to confirm your selection.

👉 Tip: If you select the wrong language by accident, you can change the language again later in the "Settings" menu (see section 4.6.).

Step 2 Filter:

→ A Claris filter is supplied. Using the filter reduces the need for descaling your appliance as the filter softens the water. You can decide whether you want to use the appliance with or without the filter. Follow the instructions on the display.

→ If you wish to operate the appliance **with the filter**, carefully screw the filter into the mounting provided in the water tank using the installation aid on the end of the measuring spoon.

⚠ Warning: Do not overtighten or bend the filter.

i Information: If you wish to operate the appliance without the filter, the filter setting must be set to "INSERT FILTER? NO!". This is important because descaling must be carried out more often without a filter, depending on the water hardness (the appliance is delivered with the factory setting "FILTER? NO!".

i Information: If you use the appliance with the filter and have programmed the system to "FILTER? YES!", the water hardness setting option does not apply. Internally, the water hardness is set to level 1 automatically. In this case, you do not need to descale your appliance as often - but you must always descale it when prompted to do so and always when REMOVED FILTER is shown.

Once approximately 50 l of water has been supplied, the filter is no longer effective (Change filter - see section 5.8).

⚠ Warning: Even if the appliance does not prompt you to change the filter, the filter must be changed after no longer than two months, even if the appliance is only used occasionally (see section 5.8.).

Step 3 Water hardness:

→ How soon your appliance needs to be descaled will depend on the water hardness in your area. So that the system can display in good time when descaling is required, you must set the correct water hardness prior to first use. To do this, please follow the instructions on the display.

The basic factory setting for water hardness is **LEVEL 3**.

Initially, test the quality of your water with the test strip provided:

→ Immerse the test strip in the water for a short period and shake it slightly.

→ After approximately one minute you can read the result by counting the red dots on the test strip.

→ The different levels are broken down and adjustable as follows:

Test strip / level of hardness = display

1 red dot / 1–7° = LEVEL 1

2 red dots / 8–14° = LEVEL 2

3 red dots / 15–21° = LEVEL 3

4 red dots / >21° = LEVEL 4

i Information: If no dot turns red, set it to level 1.

Step 4 Water:

Fill the tank with fresh water above the minimum mark (0.5 l) and insert it back into the appliance. Close the cover on the left-hand side of the device again (figure 1/F).

⚠ Warning: Always fill the water tank with clear, cold water only! Never use carbonated water or other fluids! Non-compliance will void any guarantee claims.

Step 5 Beans:

Open the bean container lid (figure 1/G). Fill it with untreated, roasted coffee beans only. Close the lid again and ensure it is in the correct position.

⚠ Warning: Do not use beans that have been treated with additives like sugar or similar products during or after the roasting process. This may cause damage to the grinder. The resulting repair costs are not covered by the guarantee.

→ Press the rotary.

Congratulations - initial start-up has been successful!

Fill the system

i Information: The system must be filled with water before you can prepare your first beverage.

→ Place a sufficiently large container (at least 0.5 l) under the outlet (figure 1/E) and press the rotary or tap on "START".

The system will now be filled. The display shows "SYSTEM FILLS". When operating the appliance with the filter, the filter will now be rinsed. The display shows "FILTER RINSES".

→ Wait a few moments until no more water comes out of the outlet.

⚠ Warning: When the appliance is heated, an important message regarding drink preparation appears on the display. Now please also read section 2.3 for further information.

2.3. Key control elements and basic functions

Your NIVONA appliance offers you a variety of ways to prepare speciality coffees just the way you like them. The key control elements and their basic function are identical for various coffee specialities:

It is up to you whether you prefer to use the touch screen or the rotary turn/push selection dial (rotary for short).

Operating the appliance with the touch screen
(figure 1/A):

short tap or tap and hold (see below)

In the beverages menu

- A short tap on a beverage symbol **in the beverages menu** (figure 1/A) prompts the appliance to start preparing the chosen beverage **immediately**.
- By **tapping and holding** a beverage symbol **in the main beverages menu** (figure 1/A), you will enter the **recipe view** for the beverage in question and can enter your individual settings as follows.

Operation with the rotary (figure 1/B):

turn to change, short press or press and hold (see below)

In the beverages menu

- Turn the rotary to a beverage symbol **in the main beverages menu** (figure 1/A) and then apply a **short press** on the rotary to start preparing the chosen beverage **immediately**.
- Turn the rotary to a beverage symbol **in the main beverages menu** (figure 1/A) and **press and hold** the rotary to enter the **recipe view** for the chosen beverage, where you can enter your individual settings as follows.

In the recipe view

- A **short tap** on a parameter **in the recipe view** will cause this parameter to flash red (figure 3) to show that the value of this parameter can now be changed. Change and confirm the value of this parameter using the rotary (figure 1/B) as follows.

- Turn the rotary to change the value of the parameter flashing red **in the recipe view**. **Press** the rotary to confirm the parameter value you have set.

Switching between the three main menus:

In order to switch between the main menus for beverages, settings and maintenance, **tap** on the relevant symbol in the first line of the display (figure 4).

In the settings and maintenance menu
(figure 1/C and D)

- **Tapping** on the symbol for **settings** (figure 1/C) or the symbol for **maintenance** (figure 1/D) in the top line of the display (figure 1/A) will take you to the relevant menu where you can input your settings using the rotary.

- **Turn** the rotary to select a menu item **in the settings** (figure 1/C) **and maintenance** (figure 1/D) **menus**. **Press** the rotary to confirm the selected menu item.

Back arrow:

- **Tap** on the **arrow** pointing left in the top line of the display (figure 3) to go back a step in the menu.

Height-adjustable outlet (figure 1/E):

You can adjust the outlet to the height of your cups or glasses by moving it up or down. Hold the outlet between your thumb and index finger and move it up or down.

i Information: If you wish to remove the drip pan and used coffee tray, move the height-adjustable outlet up before doing so.

MilkContainer:

Fill the MilkContainer with fresh, cold, low fat milk. Close the MilkContainer lid and connect one end of the suction tube to the MilkContainer and the other end to the outlet (figure 5).

i Information: A factory setting is programmed for each coffee speciality. This means you can prepare a coffee straightaway (section 3.).

In the recipe view

- Turn the rotary to a parameter **in the recipe view** and apply a **short press** on the rotary. This parameter will now flash red (figure 3) to show that the value of this parameter can now be changed. Change and confirm the value of this parameter using the rotary (figure 1/B) as follows.

- Turn the rotary to change the value of the parameter flashing red **in the recipe view**. **Press** the rotary to confirm the parameter value you have set.

Switching between the three main menus:

In order to switch between the main menus for beverages, settings and maintenance, **turn** the rotary to the relevant symbol in the first line of the display (figure 4) and then **press the rotary**.

In the settings and maintenance menu
(figure 1/C and D)

- **Turn** the rotary to the symbol for **settings** (figure 1/C) or the symbol for **maintenance** (figure 1/D) in the top line of the display (figure 1/A) and then **press** the rotary to take you to the relevant menu where you can input your settings using the rotary.

- **Turn** the rotary to select a menu item **in the settings** (figure 1/C) **and maintenance** (figure 1/D) **menus**. **Press** the rotary to confirm the selected menu item.

Back arrow:

- **Turn** the rotary to the **arrow** pointing left in the top line of the display (figure 3) and then **press** the rotary to go back a step in the menu.

When preparing for the first time: When you prepare a coffee for the first time, the grinding chamber is still empty. Following the first grinding process, the display may show “FILL BEANS” and the appliance may not prepare any coffee.

→ Follow the instructions on the display and press the rotary again.

The process will then be repeated.

i Information: For production reasons, the pipes in the appliance may remain empty during initial set-up. The notification “Please fill system” will appear after the appliance has been turned on with the On/Off button (figure 1/H).

When the appliance is ready for use, the main beverages menu will appear in the display.

2.4. Turning on the appliance during operation

If you have performed initial start-up during set up (section 2.2.), proceed as follows each time the apparatus is subsequently turned on:

→ Turn the appliance on with the On/Off button (figure 1/H).

The notification “SYSTEM HEATS” will appear in the display.

When the appliance is heated, “Please rinse system” will appear in the display.

→ Press the rotary.

The system will now be rinsed. “SYSTEM RINSES” will appear in the display. The appliance will then be ready to operate. The main beverages menu will appear in the display (figure 1/A).

i Information: When you are not using the device for a longer period of time (e.g. due to a holiday), turn off the device with the On/Off button (figure 1/H) and remove the plug from the socket.

2.5. ECO mode

When you do not use the rotary or the touch screen for a longer period of time, the appliance automatically switches to ECO mode. The display shows “SAVE ENERGY”.

→ You can exit ECO mode by pressing the rotary.

The display shows the main beverages menu.

3. Preparing coffee specialities

When preparing for the first time: When you prepare a coffee for the first time, the grinding chamber is still empty. Following the first grinding process, the display may show “FILL BEANS” and the appliance may not prepare any coffee.

→ Follow the instructions on the display and press the rotary again.

The process will then be repeated.

3.1. How to operate

Your NIVONA appliance offers you a variety of ways to prepare speciality coffees just the way you like them. The key control elements and their basic function are identical for various coffee specialities:

It is up to you whether you prefer to use the touch screen or the rotary turn/push selection dial (rotary for short).

Operating the appliance with the touch screen
(figure 1/A):

short tap or tap and hold (see below)

Operation with the rotary (figure 1/B):

turn to change, short press or press and hold (see below)

In the beverages menu

- A short tap on a beverage symbol in the **beverages menu** (figure 1/A) prompts the appliance to start preparing the chosen beverage **immediately**.
- By **tapping and holding** a beverage symbol in the **main beverages menu** (figure 1/A), you will enter the **recipe view** for the beverage in question and can enter your individual settings as follows.

In the recipe view

- A **short tap** on a parameter in the **recipe view** will cause this parameter to flash red (figure 3) to show that the value of this parameter can now be changed. Change and confirm the value of this parameter using the rotary (figure 1/B) as follows.
- Turn the rotary to change the value of the parameter flashing red in the **recipe view**. **Press** the rotary to confirm the parameter value you have set.

In the beverages menu

- Turn the rotary to a beverage symbol in the **main beverages menu** (figure 1/A) and then apply a **short press** on the rotary to start preparing the chosen beverage **immediately**.
- Turn the rotary to a beverage symbol in the **main beverages menu** (figure 1/A) and **press and hold** the rotary to enter the **recipe view** for the chosen beverage, where you can enter your individual settings as follows.

In the recipe view

- Turn the rotary to a parameter in the **recipe view** and apply a **short press** on the rotary. This parameter will now flash red (figure 3) to show that the value of this parameter can now be changed. Change and confirm the value of this parameter using the rotary (figure 1/B) as follows.
- Turn the rotary to change the value of the parameter flashing red in the **recipe view**. **Press** the rotary to confirm the parameter value you have set.

3.2. Beverages without milk (espresso, coffee, caffè americano)

The factory standard setting

- **for espresso is:** strength normal, aroma intense, temperature hot, quantity coffee 40 ml, total volume 40 ml
- **for coffee is:** strength normal, aroma dynamic, temperature hot, quantity coffee 120 ml, total volume 120 ml
- **for caffè americano is:** strength normal, aroma constant, temperature hot, quantity coffee 80 ml, quantity water 40 ml, total volume 120 ml.

In the recipe view for a beverage (tap or press and hold a beverage symbol), you can alter the following parameters for each beverage (for how to operate see 3.1.).

Choose strength (espresso, coffee, caffè americano)

- Select the bean symbol to alter the coffee strength.
- When the bean symbol is flashing red, turn the rotary to alter the coffee strength: The more beans are displayed, the stronger the beverage will be.
- Confirm the value set by pressing the rotary.

Choose aroma (espresso, coffee, caffè americano)

You can adjust the aroma for your coffee to your own preference. For this, three profiles for the flow velocity of the water through the coffee grounds are stored under the parameter “AROMA”. The “DYNAMIC” profile ensures a dynamic flow, the “CONSTANT” profile a constant flow and the “INTENSE” profile ensures an intense flow.

Tip: Test out your favourite aroma profile on one of the beverages. By the way: Your favourite aroma profile may change when you switch between types of coffee.

- Select the aroma symbol to alter the aroma.

- When the aroma symbol is flashing red, turn the rotary to alter the aroma.
- Confirm the value set by pressing the rotary.

Choose temperature (espresso, coffee, caffè americano)

- Select the temperature symbol to alter the temperature.
- When the temperature symbol is flashing red, turn the rotary to alter the temperature.
- Confirm the value set by pressing the rotary.

Choose quantity coffee (espresso, coffee, caffè americano)

- Select the ml display in the brown area of the cup symbol to alter the coffee quantity.
- When the ml display is flashing red, turn the rotary to alter the coffee quantity.
- Confirm the value set by pressing the rotary.

Choose quantity hot water (caffè americano)

- Select the ml display in the blue area of the cup symbol to alter the hot water quantity.
- When the ml display is flashing red, turn the rotary to alter the hot water quantity.
- Confirm the value set by pressing the rotary.

Save settings

- Turn the rotary to SAVE and press the rotary or tap on SAVE.

i **Information:** You can now access your saved settings directly from the main beverages menu with a short tap or short press on the rotary on the relevant beverage symbol.

Preparing two cups (not for caffè americano)

- Select the cup symbol on the right-hand side of the recipe screen.
- When the cup symbol is flashing red, turn the rotary to alter the number of cups.
- Confirm the value set by pressing the rotary.

Positioning cups

- Place one cup in the centre or two cups to the left and right under the outlet (figure 6/7).

i **Information:** Ensure the size of your cups/glasses is suitable for the total quantity set (ml display above the cup symbol).

Start beverage preparation

- Turn the rotary to START and press the rotary or tap on START.

i **Information:** If you have started preparation by accident or too early, you can still alter some parameters during preparation. The parameters you can alter are shown flashing red.

- While the parameter is flashing red, you can alter the value set using the rotary.
- If you would like to cancel preparation, press the rotary again or tap on "CANCEL".

i **Information:** You can also program beverage recipes live during beverage preparation. To do this, follow the instructions given in section 4.1. "LIVE PROGRAMMING".

3.3. Beverages with milk (CAPPUCCINO, CAFFÈ LATTE, LATTE MACCHIATO, MILK/MILK FROTH)

- Fill the MilkContainer with fresh, cold, low fat milk. Close the MilkContainer lid and connect one end of the suction tube to the MilkContainer and the other end to the outlet (figure 5).

The factory standard setting

- **for cappuccino is:** strength normal, aroma constant, temperature hot, milk first, quantity coffee 40 ml, quantity milk froth 160 ml, total volume 200 ml.
- **for caffè latte is:** strength normal, aroma constant, temperature hot, milk first, quantity coffee 40 ml, quantity milk 160 ml, total volume 200 ml.
- **for latte macchiato is:** strength normal, aroma constant, temperature hot, milk first, quantity coffee 60 ml, quantity milk 40 ml, quantity milk froth 200 ml, total volume 300 ml.

- **for milk/milk froth is:** temperature hot, quantity milk 0 ml, quantity milk froth 150 ml, total volume 150 ml.

In the recipe view for a beverage (tap or press and hold a beverage symbol), you can alter the following parameters for each beverage (for how to operate see 3.1.).

Choose strength (CAPPUCCINO, CAFFÈ LATTE, LATTE MACCHIATO)

- Select the bean symbol to alter the coffee strength.
- When the bean symbol is flashing red, turn the rotary to alter the coffee strength: The more beans are displayed, the stronger the beverage will be.
- Confirm the value set by pressing the rotary.

Choose aroma (CAPPUCCINO, CAFFÈ LATTE, LATTE MACCHIATO)

You can adjust the aroma for your coffee to your own preference. For this, three profiles for the flow velocity of the water through the coffee grounds are stored under the parameter "AROMA". The "DYNAMIC" profile ensures a dynamic flow, the "CONSTANT" profile a constant flow and the "INTENSE" profile ensures an intense flow.

👍 Tip: Test out your favourite aroma profile on one of the beverages. By the way: Your favourite aroma profile may change when you switch between types of coffee.

- Select the aroma symbol to alter the aroma.
- When the aroma symbol is flashing red, turn the rotary to alter the aroma.
- Confirm the value set by pressing the rotary.

Choose temperature (CAPPUCCINO, CAFFÈ LATTE, LATTE MACCHIATO, MILK/MILK FROTH)

- Select the temperature symbol to alter the temperature.
- When the temperature symbol is flashing red, turn the rotary to alter the temperature.
- Confirm the value set by pressing the rotary.

Choose coffee/milk order (CAPPUCCINO, CAFFÈ LATTE, LATTE MACCHIATO)

- Select the order symbol to change the order of coffee and milk.
- When the order symbol is flashing red, turn the rotary to change the order: coffee first or milk first.
- Confirm the value set by pressing the rotary.

Choose quantity milk (CAFFÈ LATTE, LATTE MACCHIATO, MILK/MILK FROTH)

- Select the ml display in the lower white area of the cup symbol to alter the milk quantity.
- When the ml display is flashing red, turn the rotary to alter the milk quantity.
- Confirm the value set by pressing the rotary.

Choose quantity coffee (CAPPUCCINO, CAFFÈ LATTE, LATTE MACCHIATO)

- Select the ml display in the brown area of the cup symbol to alter the coffee quantity.
- When the ml display is flashing red, turn the rotary to alter the coffee quantity.
- Confirm the value set by pressing the rotary.

Choose quantity milk froth (CAPPUCCINO, CAFFÈ LATTE, LATTE MACCHIATO, MILK/MILK FROTH)

- Select the ml display in the upper white area of the cup symbol to alter the milk froth quantity.
- When the ml display is flashing red, turn the rotary to alter the milk froth quantity.
- Confirm the value set by pressing the rotary.

👍 Tip: If you would like hot milk, set the quantity of milk froth to 0 ml (upper white area of the cup symbol) and just alter the quantity in the lower white area of the cup symbol.

Save settings

- Turn the rotary to SAVE and press the rotary or tap on SAVE.

i **Information:** You can now access your saved settings directly from the main beverages menu with a short tap or short press on the rotary on the relevant beverage symbol.

Preparing two cups

- Select the cup symbol on the right-hand side of the recipe screen.
- When the cup symbol is flashing red, turn the rotary to alter the number of cups: one or two cups.
- Confirm the value set by pressing the rotary.

Positioning cups

- Place one cup in the centre or two cups to the left and right under the outlet (figure 6/7).

i **Information:** Ensure the size of your cups/glasses is suitable for the total quantity set (ml display above the cup symbol).

Start beverage preparation

- Turn the rotary to START and press the rotary or tap on START.

i **Information:** If you have started preparation by accident or too early, you can still alter some parameters during preparation. The parameters you can alter are shown flashing red.

- While the parameter is flashing red, you can alter the value set using the rotary.
- If you would like to cancel preparation, press the rotary again or tap on "CANCEL".

i **Information:** You can also program beverage recipes live during beverage preparation. To do this, follow the instructions given in section 4.1. "LIVE PROGRAMMING".

! **Warning:** Dried milk residues are hard to remove. Therefore, please clean everything properly after cooling! Always follow the "RINSE FROTHER" instruction given on the display.

👉 **Tip:** If you do not require the suction tube, you can leave one end inserted in the outlet and fix the loose end in the clamp by the outlet.

3.4. Hot water (e.g. for tea)

The factory standard setting is: Temperature hot, quantity hot water 150 ml, total volume 150 ml.

In the recipe view for hot water (tap or press and hold the hot water symbol in the main beverages menu), you can alter the following parameters for each beverage (for how to operate see 3.1.).

Choose temperature

- Select the temperature symbol to alter the temperature.
- When the temperature symbol is flashing red, turn the rotary to alter the temperature.
- Confirm the value set by pressing the rotary.

Choose quantity hot water

- Select the ml display in the blue area of the cup symbol to alter the hot water quantity.
- When the ml display is flashing red, turn the rotary to alter the hot water quantity.
- Confirm the value set by pressing the rotary.

Save settings

- Turn the rotary to SAVE and press the rotary or tap on SAVE.

i **Information:** You can now access your saved setting directly from the main beverages menu with a short tap or press on the rotary on the hot water symbol.

Positioning cups

- Place a cup in the centre under the outlet (figure 6).

i **Information:** Ensure the size of your cup/glass is suitable for the total quantity set (ml display above the cup symbol).

i **Information:** It is only possible to prepare hot water for one cup/glass.

Start hot water preparation

- Turn the rotary to START and press the rotary or tap on START.

i **Information:** If you have started preparation by accident or too early, you can still alter some parameters during preparation. The parameters you can alter are shown flashing red.

- While the parameter is flashing red, you can alter the value set using the rotary.
- If you would like to cancel preparation, press the rotary again or tap on "CANCEL".

i **Information:** You can also program beverage recipes live during beverage preparation. To do this, follow the instructions given in section 4.1. "LIVE PROGRAMMING".

3.5. Setting "My coffee" for me and others according to taste

With your appliance, you can set up a coffee completely according to taste for up to nine different people or beverages.

Tap or turn and press the rotary to select MY COFFEE in the beverages menu. This will open up an overview of nine MY COFFEE beverages, from MY COFFEE 1 to MY COFFEE 9.

In the factory, all nine beverages are set with the standard setting for "MY COFFEE":

strength normal, aroma intense, temperature high, quantity coffee 40 ml, total volume 40 ml.

- To prepare a MY COFFEE beverage, select the beverage you would like.

You can change both the name and the recipe for each of these nine MY COFFEE beverages.

- Select the beverage you would like to change (e.g. MY COFFEE 1).

This will open up an overview of possible beverage types.

- Select a beverage (e.g. LATTE MACCHIATO).

This will open up the recipe view for the selected beverage (e.g. LATTE MACCHIATO). You can alter the parameters for each beverage in the recipe view (for how to operate see 3.1.).

Edit recipe

- Select the parameter you would like to change.
- When this parameter is flashing red, turn the rotary to alter the parameter.
- Confirm the value set by pressing the rotary.

Edit name

You can assign an individual name including an icon for all "MY COFFEE" recipes.

- Tap or turn and then press the rotary to select "EDIT NAME". This will open up a keyboard.
- Turn the rotary to the letter or character of your choice. Press the rotary to enter the selected letter or character. Or tap on the letter or character of your choice.
- Repeat this step until you have entered the name of the recipe in full.
- Confirm the name you have entered by pressing "OK".

The recipe view will appear again.

Delete recipe

- Selecting "DELETE" will delete the selected recipe including its name and restore the factory settings (see above) for this beverage.

Save settings

- Turn the rotary to SAVE and press the rotary or tap on SAVE.

An overview will appear containing nine MY COFFEE beverages with the names MY COFFEE 1 to MY COFFEE 9 or with the new name and beverage symbol for the beverage you have just programmed.

i **Information:** You can now access your saved settings directly from the My Coffee menu with a short tap or short press on the rotary on the relevant beverage symbol.

i **Information:** This method can be used to change the name and recipe for all nine "MY COFFEE" beverages.

3.6. Set grinding degree

⚠ Warning: The grinding degree should only be changed while the grinder is running.

You can adjust the grinding degree accordingly, depending on the roasting of your coffee beans. We recommend you always leave the grinder on a medium setting.

To change the grinding degree, please proceed as follows:

- Open the service door on the right-hand side of the casing (figure 1/L and figure 8) by pulling the unlocking device in the handle (figure 1/K) gently upwards and carefully moving the service door away from the appliance casing.

The regulator for the grinding degree is at the top right.

- Place a cup under the height-adjustable outlet.
- Turn the rotary to “ESPRESSO” in the main beverages menu. Press the rotary.
- **While the mill is grinding**, change the grinding degree by moving the regulator (figure 9).

By moving the regulator to the left, the grinding degree becomes finer, to the right coarser. Here it should be noted that:

- a light roast requires a finer setting (move regulator further to the left),
- a dark roast requires a coarser setting (move regulator further to the right).

👍 Tip: Test out the setting that suits you best according to your individual taste.

- Close the service door again, ensuring that you guide the pins at the bottom of the service door into the gaps (figure 8). Shut the service door until it clicks.

3.7. Prepare ground coffee (e.g. decaffeinated coffee)

- Open the ground coffee chamber lid below the cover in the top right corner of the device (figure 1/M and figure 10).

The display will show “1. FILL GROUND COFFEE 2. CLOSE GROUND COFFEE CHAMBER”.

- Pour in one level measuring spoon of ground coffee and close the cover and lid again. The display will show “GROUND COFFEE IS READY”.
- Place a cup in the centre under the coffee spout (figure 6).
- Select a beverage in the main beverages menu.
- Start beverage preparation.

i Information: If you have started preparation by accident or too early, you can still alter some parameters during preparation. The parameters you can alter are shown flashing red.

- While the parameter is flashing red, you can alter the value set using the rotary.
- If you would like to cancel preparation, press the rotary again or tap on “CANCEL”.

i Information: If you have opened the ground coffee chamber by accident – or you have not started preparing a beverage after the powder was poured in – the appliance will be automatically rinsed via the outlet (figure 1/E) approximately one minute after the lid was closed again, and is then ready to operate again.

⚠ Warning: The ground coffee chamber is not a storage container. Therefore, never pour more than one portion into the chamber and use fresh or vacuum-packed powder from ground beans only. Water soluble instant coffee must not be used!

4. Set/change basic settings

i Information: A factory setting is programmed for each coffee speciality. This means you can prepare a coffee straightaway (see section 3.). Or you can start by changing the following basic settings according to your individual requirements.

- To change the basic settings, tap on the settings symbol in the main menu (figure 1/C) or select the settings symbol by turning the rotary and then pressing the rotary.

- Turn the rotary to choose the menu item you would like to change in the “SETTINGS” menu.
- Press the rotary to access the chosen menu item.
- Turn the rotary in the respective menu item to change the respective setting.
- Press the rotary to confirm your chosen setting.
- Tap or select the arrow button and then press the rotary to move to the next menu level above.

i Information: In order to return to the main menu from the settings menu, tap on the beverage symbol or select the beverage symbol with the rotary and then press the rotary.

4.1. Live programming beverage recipes

i Information: A factory setting is programmed for each coffee speciality. This means you can prepare a coffee straightaway (see section 3.).

i Information: If you wish to change a beverage recipe, you can do this as described in this section or individually in the recipe screen (see section 3.).

You can change and save the standard setting during preparation as follows.

- Turn the rotary to select the settings symbol (figure 1/C) in the main menu and then press the rotary or tap on the settings symbol.
- Turn the rotary to “LIVE PROGRAMMING”. Press the rotary.
- Turn the rotary to the beverage of your choice (e.g. “ESPRESSO”). Press the rotary.
- Place a cup in the centre under the outlet (figure 6).
- Follow the instructions on the display.

For coffee beverages: The display shows “CHOOSE STRENGTH”.

- Turn the rotary to set the strength of your choice (weaker to the left and stronger to the right).
- Press the rotary to confirm your chosen strength.

For coffee beverages: The display shows “CHOOSE AROMA”.

- Turn the rotary to set the aroma profile of your choice (for an explanation of aroma profiles see section 3.2. or 3.3.).
- Press the rotary to confirm your chosen aroma.

For all beverages: “CHOOSE TEMPERATURE” appears on the display.

- Turn the rotary to set the temperature of your choice.
- Press the rotary to confirm your chosen temperature.

For cappuccino: “CHOOSE ORDER” appears on the display.

- Turn the rotary to set the order of either coffee first or milk first.
- Press the rotary to confirm your chosen order.

The display shows “PLEASE WAIT”. The device will grind, heat up and then commence preparation.

For beverages with milk: The display shows “STOP MILK?”

- Press the rotary when the desired amount of milk has been prepared.

For beverages with milk froth: The display shows “STOP MILK FROTH?”

- Press the rotary when the desired amount of milk froth has been prepared.

For coffee beverages: The display shows “STOP COFFEE?”

- Press the rotary when the desired amount of coffee has been prepared.

For beverages with water: The display shows “STOP WATER?”

- Press the rotary when the desired amount of water has been prepared.

The standard setting for the beverage of your choice (e.g. espresso) has now been changed and saved. The display will show “RECIPE CREATED” for a short time and will then switch to the “LIVE PROGRAMMING” sub-menu to allow you to program further beverages.

→ Tap or select the arrow button and then press the rotary to move to the next menu level above.

i Information: In order to return to the main beverages menu from the settings menu, tap on the beverage symbol or select the beverage symbol with the rotary and then press the rotary.

4.2. Times

Set an automatic switch-off time

This function allows you to set if, and after how long since last use, the appliance should switch itself off automatically. The factory setting is after "10 MINUTES".

- Turn the rotary to select the settings symbol (figure 1/C) in the main menu and then press the rotary or tap on the settings symbol.
- Turn the rotary to "TIMES". Press the rotary.
- Turn the rotary to "UNIT AUTO-OFF". Press the rotary.

The display shows the possible switch-off times.

- Turn the rotary to set the desired switch-off time.
- Press the rotary to confirm your setting.

Your appliance will now switch itself off automatically after the set switch-off time after the last use.

Set an automatic switch-on time

Your appliance can automatically switch itself on at a set switch-on time every day. This way, your appliance will be ready to use at breakfast time, for example. You can set the switch-on time as follows:

- Turn the rotary to select the settings symbol in the main menu and then press the rotary or tap on the settings symbol.
- Turn the rotary to "TIMES". Press the rotary.
- Turn the rotary to "UNIT AUTO-ON". Press the rotary.
- Turn the rotary to "ENABLE". Press the rotary.

The display shows the time.

- Turn the rotary to the current hour. Press the rotary.
- Turn the rotary to the current minute. Press the rotary.

The time has now been set. The display shows "SET AUTO-ON".

- Turn the rotary to the desired switch-on hour. Press the rotary.
- Turn the rotary to the desired switch-on minute. Press the rotary.

The switch-on time has now been set.

You can deactivate the automatic switch-on time as follows:

- Turn the rotary to select the settings symbol in the main menu and then press the rotary or tap on the settings symbol.
- Turn the rotary to "TIMES". Press the rotary.
- Turn the rotary to "UNIT AUTO-ON". Press the rotary.
- Turn the rotary to "DISABLE". Press the rotary.

The automatic switch-on time has now been deactivated.

⚠ Warning: If the appliance has been disconnected from the mains or in the event of a power cut, the time must be reset in order to be able to use the automatic switch-on time.

i Information: Remember to take daylight savings into account as regards the current time.

→ Tap or select the arrow button and then press the rotary to move to the next menu level above.

i Information: In order to return to the main beverages menu from the settings menu, tap on the beverage symbol or select the beverage symbol with the rotary and then press the rotary.

4.3. Comfort settings

Water tank lighting

This function allows you to set whether the water tank is to be illuminated and, if so, what colour.

- Turn the rotary to select the settings symbol (figure 1/C) in the main menu and then press the rotary or tap on the settings symbol.
- Turn the rotary to "COMFORT SETTINGS". Press the rotary.
- Turn the rotary to "WATER TANK LIGHTING". Press the rotary.
- Turn the rotary to your desired setting – either "OFF" or select a colour. Press the rotary.

The display shows further comfort settings.

Lock screen

This function allows you to set whether the display's touchscreen function is to be locked. If you set this function to "ON", the display will be locked when it is not used for a long period of time. This allows the appliance to save energy and protects it from inadvertent activation.

i Information: If the display is locked, it can be released again by pressing the rotary.

- Turn the rotary to select the settings symbol in the main menu and then press the rotary or tap on the settings symbol.
- Turn the rotary to "COMFORT SETTINGS". Press the rotary.
- Turn the rotary to "LOCK SCREEN". Press the rotary.
- Turn the rotary to your desired setting – "ON" or "OFF". Press the rotary.

The display shows further comfort settings.

Switch-off rinsing

Switch-on rinsing is permanently installed in the factory. After each switch-on from cold stand by mode, the appliance heats up again and triggers a rinsing request so that it always operates with fresh water.

The display shows this rinsing request. It can be started manually by pressing the rotary.

The factory setting for **switch-off** rinsing is set to "ON".

There is the option to deactivate switch-off rinsing after switching off the device.

- Turn the rotary to select the settings symbol in the main menu and then press the rotary or tap on the settings symbol.
- Turn the rotary to "COMFORT SETTINGS". Press the rotary.
- Turn the rotary to "OFF-RINSE". Press the rotary.
- Turn the rotary to your desired setting – "ON" or "OFF". Press the rotary.

The display shows further comfort settings.

i Information: Switch-off rinsing is only carried out if at least one coffee or milk beverage has been prepared beforehand, even if switch-off rinsing is set to "ON".

→ Tap or select the arrow button and then press the rotary to move to the next menu level above.

i Information: In order to return to the main beverages menu from the settings menu, tap on the beverage symbol or select the beverage symbol with the rotary and then press the rotary.

4.4. Set operation with or without a filter

- Turn the rotary to select the settings symbol (figure 1/C) in the main menu and then press the rotary or tap on the settings symbol.
- Turn the rotary to select the "FILTER" item in the "SETTINGS" menu.
- Turn the rotary to your desired setting – "FILTER? YES!" or "FILTER? NO!" Press the rotary.

Operate appliance with a filter: Please follow the procedure given in section 2.2. step 2 and the instructions on the display.

Operate appliance without a filter: Please follow the procedure given in section 2.2. step 3 and the instructions on the display.

→ Tap or select the arrow button and then press the rotary to move to the next menu level above.

i Information: In order to return to the main beverages menu from the settings menu, tap on the beverage symbol or select the beverage symbol with the rotary and then press the rotary.

4.5. Set water hardness

→ Turn the rotary to select the settings symbol (figure 1/C) in the main menu and then press the rotary or tap on the settings symbol.

→ Turn the rotary to select the “WATER HARDNESS” item in the “SETTINGS” menu. Press the rotary.

Please follow the procedure given in section 2.2. step 3 and the instructions on the display.

→ Tap or select the arrow button and then press the rotary to move to the next menu level above.

i Information: In order to return to the main beverages menu from the settings menu, tap on the beverage symbol or select the beverage symbol with the rotary and then press the rotary.

4.6. Set language

→ Turn the rotary to select the settings symbol (figure 1/C) in the main menu and then press the rotary or tap on the settings symbol.

→ Turn the rotary to select the “LANGUAGE” item in the “SETTINGS” menu. Press the rotary.

→ Turn the rotary to change the language.

→ Press the rotary to confirm your selected language.

→ Tap or select the arrow button and then press the rotary to move to the next menu level above.

i Information: In order to return to the main beverages menu from the settings menu, tap on the beverage symbol or select the beverage symbol with the rotary and then press the rotary.

4.7. Request statistics

In the menu item “STATISTICS”, you can view how often you have prepared different beverages and used different features since the appliance was set up.

→ Turn the rotary to select the settings symbol (figure 1/C) in the main menu and then press the rotary or tap on the settings symbol.

→ Turn the rotary to “STATISTICS”. Press the rotary.

→ Turn the rotary to view the different statistics.

→ To exit, press the rotary.

→ Tap or select the arrow button and then press the rotary to move to the next menu level above.

i Information: In order to return to the main beverages menu from the settings menu, tap on the beverage symbol or select the beverage symbol with the rotary and then press the rotary.

4.8. Factory settings

You can reset recipes or settings to factory settings in the “FACTORY SETTINGS” menu item.

→ Turn the rotary to select the settings symbol (figure 1/C) in the main menu and then press the rotary or tap on the settings symbol.

→ Turn the rotary to “FACTORY SETTINGS”. Press the rotary.

→ Turn the rotary to “RESET RECIPES” or “RESET SETTINGS”.

→ Press the rotary to confirm your setting.

→ Tap or select the arrow button and then press the rotary to move to the next menu level above.

i Information: In order to return to the main beverages menu from the settings menu, tap on the beverage symbol or select the beverage symbol with the rotary and then press the rotary.

4.9. Bluetooth

You can obtain an application (app) in the Apple App Store or Google Play Store for your NIVONA fully automatic coffee machine, which allows you to control and operate the main functions of your coffee machine. The “BLUETOOTH” menu item allows you to enable or disable a connection between your device and smartphone.

→ Turn the rotary to select the settings symbol (figure 1/C) in the main menu and then press the rotary or tap on the settings symbol.

→ Turn the rotary to “BLUETOOTH”. Press the rotary.

→ Turn the rotary to “CONNECT” to connect to your smartphone. Then follow the app instructions on your smartphone.

→ Turn the rotary to “DISABLE” to cancel the connection to your smartphone or to disallow it.

→ Press the rotary to confirm your setting.

→ Tap or select the arrow button and then press the rotary to move to the next menu level above.

i Information: In order to return to the main beverages menu from the settings menu, tap on the beverage symbol or select the beverage symbol with the rotary and then press the rotary.

AROMA PRE-select for NIVONA coffees via the app

NIVONA has developed three exquisite coffee roasts for you with an experienced coffee roaster:

Café BERGAMO

Café MILANO

Café TORINO

You can obtain these NIVONA coffees from your retailer (see also www.nivona.com).

With the NIVONA app, you can send the aroma settings recommended by NIVONA to your NIVONA appliance.

It's that simple: Purchase coffee from your retailer, download the app onto your smartphone and send the aroma settings.

We hope you enjoy great coffee with a superb aroma.

5. Cleaning and maintenance

Messages will appear in the first line of your NIVONA appliance's display prompting you to carry out some of the cleaning and maintenance activities given below (e.g. “PLEASE RINSE FROTHER”).

→ When you receive one of these cleaning or maintenance messages, turn the rotary to “START” and press the rotary. Or tap on “START”.

Your appliance will commence the relevant cleaning or maintenance process and messages on the display will prompt you to carry out any further activities.

→ Follow the instructions on the display. In case of doubt, further details can be found in sections 5.1. to 5.9. below.

5.1. Rinse frother

⚠ Warning: The running programme must not be interrupted!

You should rinse the milk frother after preparing beverages with milk, and when the display prompts you to do so at the very latest. To do this, proceed as follows:

→ Turn the rotary to select the maintenance symbol (figure 1/D) in the main menu and then press the rotary or tap on the maintenance symbol.

→ Turn the rotary to “RINSE FROTHER” and then press the rotary or tap on “RINSE FROTHER”.

→ Connect one end of the tube provided to the height-adjustable outlet (figure 11).

→ Place the other end of the tube in the back right of the drip pan (figure 11).

→ Place a sufficiently large container (at least 0.5 l) under the height-adjustable outlet.

→ Press the rotary or tap on “NEXT”.

The display shows “FROTHER RINSES, DO NOT REMOVE TUBE”. The appliance will commence the rinsing process. Once the rinsing cycle has finished, the appliance will heat up and is then ready to operate again. The main beverages menu will appear in the display.

5.2. Rinse the system

You should rinse the system from time to time. To do this, proceed as follows:

- Turn the rotary to select the maintenance symbol (figure 1/D) in the main menu and then press the rotary or tap on the maintenance symbol.
- Turn the rotary to “RINSE SYSTEM” and then press the rotary or tap on “RINSE SYSTEM”.

The display shows “SYSTEM RINSES”.

Once the rinsing cycle has finished, the appliance will heat up and is then ready to operate again. The main beverages menu will appear in the display.

5.3. Clean the milk frother

⚠ Warning: The running programme must not be interrupted!

i Information: When the milk frother needs to be cleaned, “PLEASE CLEAN FROTHER” will appear in the first line of the display.

To do this, proceed as follows:

- Place some cleaning agent (available as optional accessory, see section 8.) and water in a container, at least 0.3 l in total. Please follow the specifications given by the cleaning agent manufacturer concerning the mixing ratio.
- Turn the rotary to select the maintenance symbol (figure 1/D) in the main menu and then press the rotary or tap on the maintenance symbol.
- Turn the rotary to “CLEAN FROTHER” and then press the rotary or tap on “CLEAN FROTHER”.
- Follow the instructions on the display and then press the rotary or tap on “NEXT”.
- Follow the instructions on the display until the programme has finished.

The appliance will then heat up and is ready to operate again. The main beverages menu will appear in the display.

5.4. Clean the system

i Information: When the appliance needs to be cleaned, “PLEASE CLEAN SYSTEM” will appear in the first line of the display. You can still prepare beverages. However, we recommend that you run the cleaning programme as soon as possible so as not to invalidate your warranty.

⚠ Warning: The running cleaning programme must not be interrupted. Firstly, please insert a cleaning tablet in the round opening in the brewing unit when the appliance prompts you to do so.

- Place a sufficiently large container (at least 0.5 l) under the outlet (figure 1/E).
- Turn the rotary to select the maintenance symbol (figure 1/D) in the main menu and then press the rotary or tap on the maintenance symbol.
- Turn the rotary to “CLEAN SYSTEM” and then press the rotary or tap on “CLEAN SYSTEM”.
- Follow the instructions on the display and then press the rotary or tap on “NEXT”.

i Information: For information on removing and cleaning the brewing unit, see also section 5.5. below.

- Follow the instructions on the display until the programme has finished.

The appliance will then heat up and is ready to operate again. The main beverages menu will appear in the display.

5.5. Remove and clean the brewing unit

⚠ Warning: Only remove the brewing unit when the appliance is turned off.

⚠ Warning: Clean the brewing unit every time you carry out a cleaning programme, for example, but at least once a month. Otherwise, claims under the guarantee may not be accepted.

If required, the brewing unit should be taken out and cleaned under running water. Do not use cleaning agents under any circumstances – only clear, cold water!

- Open the service door on the right-hand side of the casing (figure 1/L and figure 8) by pulling the unlocking device in the handle (figure 1/K) gently upwards and carefully moving the service door away from the appliance casing.
- Unlock the brewing unit by pressing the red switch upwards and turning the handle to the left until it clicks into place (figure 12).
- Then, carefully remove the brewing unit with the handle.
- Clean the brewing unit under running water and leave to dry.
- Carefully insert the brewing unit again and lock it by holding the red switch down and turning the handle to the right until it clicks into place.
- Close the service door again, ensuring that you guide the pins at the bottom of the service door into the gaps (figure 8). Shut the service door until it clicks.

5.6. Descale system

i Information: When the appliance needs descaling, “PLEASE DESCALE” will appear in the display. However, you can also start the descaling programme manually at any time.

⚠ Warning: When descaling, please follow the instructions in the exact order as given in the display! You can still prepare beverages, even when the appliance prompts you to descale. However, we recommend you carry out the descaling programme as soon as possible. Otherwise, claims under the guarantee may not be accepted.

⚠ Warning: The running descaling programme must not be interrupted. Never use vinegar or vinegar-based agents for descaling. Please use standard, solvent products which are recommended for fully automated coffee machines.

- Turn the rotary to select the maintenance symbol (figure 1/D) in the main menu and then press the rotary or tap on the maintenance symbol.
- Turn the rotary to “DESCALE SYSTEM” and then press the rotary or tap on “DESCALE SYSTEM”.

⚠ Warning: Before starting the descaling programme, the filter must be removed from the water tank.

⚠ Warning: Add the appropriate amount of water up to the 0.5 ml mark first and then add the descaler. Never the other way round! Follow the instructions given by the descaler manufacturer.

- Place a sufficiently large container (at least 0.5 l) under the outlet (figure 1/E).
- Follow the instructions on the display and then press the rotary or tap on “NEXT”.
- Follow the instructions on the display until the programme has finished.

The appliance will then heat up and is ready to operate again. The main beverages menu will appear in the display.

⚠ Warning: Finally, please make sure you remove any descaling fluid residue left on the casing with a damp cloth.

5.7. Regular cleaning by hand

i Information: Please follow these cleaning instructions as the utmost levels of cleanliness are particularly important when handling foodstuffs.

⚠ Warning: Never submerge the appliance in water! Do not use scouring agents for cleaning.

- Clean the interior and exterior of the casing with a soft, damp cloth only. Do not use cleaning agents.
- Empty the drip pan (figure 1/N) and the used coffee tray (figure 1/O) no later than when the display prompts you to do so (only when the device is switched on, because the device will only then recognise that the trays have been emptied).
- After removing the drip pan and used coffee tray, clean the inside of the casing with a soft, damp cloth. Do not use cleaning agents.

i Information: Occasionally use some soapy water to clean the drip pan (figure 1/N).

The water tank should be rinsed with clear water daily and refilled with fresh, cool water.

⚠ Warning: Dried milk residues are hard to remove. Therefore, please clean everything properly after cooling! Always follow the “RINSE FROTHER” instruction given on the display.

→ Therefore, clean the milk frother, tube and outlet regularly.

ⓘ Information: From time to time (ideally prior to a longer break between preparing beverages, but definitely regularly!), the milk frother must be completely dismantled into its individual parts and rinsed under clear water.

- Remove the cover plate (figure 1/P) under the height-adjustable outlet.
- Pull the milk frother down to remove it (a) and dismantle it into its individual parts (figure 1/R).
- Clean the individual parts (figure 1/R) thoroughly and assemble the milk frother again.
- Push the assembled milk frother back up (b) into the height-adjustable outlet.
- Place the cover plate back on the height-adjustable outlet (figure 1/P).

ⓘ Information: Your appliance is fitted with rear wheels (figure 1/Q). These allow it to be moved on a level surface. This also allows you to clean under the appliance.

5.8. Change filter

The filter is no longer effective once approximately 50 l of water has flowed through it. The display shows “PLEASE REPLACE FILTER”.

ⓘ Information: You can still prepare beverages. However, we recommend you always change the filter immediately.

- Turn the rotary to select the settings symbol (figure 1/C) in the main menu and then press the rotary or tap on the settings symbol.
- Turn the rotary to “FILTER” and then press the rotary or tap on “FILTER”.
- Turn the rotary to “INSERT FILTER? YES” so that the appliance recognises that the filter is inserted.
- Empty the water tank (figure 1/F) and carefully unscrew the old filter from the mounting in the water tank using the installation aid on the end of the measuring spoon (figure 13).
- Dispose of the old filter in your household waste.
- Press the rotary.
- Carefully screw the new filter into the mounting provided in the water tank using the installation aid on the end of the measuring spoon (figure 13).

⚠ Warning: Do not overtighten or bend the filter.

- Fill the tank with fresh water and insert it back into the appliance.
- Place a sufficiently large container (at least 0.5 l) under the outlet (figure 1/E) and press the rotary.

The system will now be rinsed. The display shows “FILTER RINSES”.

→ Wait a few moments until no more water comes out of the outlet.

The system will heat up. The appliance is now ready to operate. The main beverages menu will appear in the display.

⚠ Warning: In the event of low water usage, you must change the filter after no more than two months. Then a notification will not appear in the display. You can set the replacement date using the rotary disk at the head of the filter (month display).

5.9. Maintenance status

Your appliance can show you whether a cleaning or descaling process is imminent.

- Turn the rotary to select the settings symbol (figure 1/C) in the main menu and then press the rotary or tap on the settings symbol.
- Turn the rotary to “STATUS OF MAINTENANCE” and then press the rotary or tap on “STATUS OF MAINTENANCE”.

The display shows:

“CLEAN SYSTEM”
“CLEAN FROTHER”
“DESCALING”
“REPLACE FILTER”

The respective progress bar shows you whether a cleaning or descaling process is imminent. The further right the progress bar is, the sooner cleaning or descaling is required.

→ Press the rotary to exit “STATUS OF MAINTENANCE”.

⚠ Warning: Please carry out cleaning and descaling regularly and no later than when the display prompts you to do so. Otherwise, claims under the guarantee may not be accepted.

6. System notifications

Notification	Meaning	Solution
Fill the system	Fill water pipe system	→ Press rotary
	Filter may be faulty	→ Remove or change filter
Fill with water	Water tank is empty	→ Fill water tank
	Water tank is missing or inserted incorrectly	→ Insert water tank correctly
Refill beans	There are no beans	→ Fill coffee beans
	Beans in container are stuck together	→ Stir beans in container with a spoon
		→ Clean bean container with a cloth
Information: The message “REFILL BEANS” only disappears after coffee has been prepared again.		
Empty trays	Drip pan and/or used coffee tray are full	→ Empty drip pan and/or used coffee tray
Trays missing	Drip pan with used coffee tray is missing or inserted incorrectly	→ Insert drip pan with used coffee tray
Cleaning required	System needs to be cleaned	→ Clean system (section 5.4.)
Descaling required	System needs to be descaled	→ Descale system (section 5.6.)
Change filter	Filter exhausted	→ Change filter (section 5.8.)
Brewing unit removed	Brewing unit inserted incorrectly	→ Insert and lock brewing unit correctly (section 5.5.)

7. Troubleshooting

Fault	Meaning	Solution
No hot water or steam supply	Milk frother is blocked	→ Please clean milk frother thoroughly and dismantle completely (figure 1/R)
Too little milk froth or liquid froth	System may be calcified	→ Please carry out high-dosage descaling (section 5.6.)
	Unsuitable milk Milk frother is blocked	→ Use cold milk → Please clean milk frother thoroughly and dismantle completely (figure 1/R)
Coffee is coming out in drops only	System may be calcified	→ Please carry out high-dosage descaling (section 5.6.)
	Grinding degree is too fine	→ Set grinding degree coarser (section 3.6.)
	Ground coffee is too fine	→ Use coarser ground coffee
Coffee is not “frothy”	System may be calcified	→ Please carry out high-dosage descaling (section 5.6.)
	Unsuitable coffee type	→ Change type of coffee
	Beans are no longer freshly roasted	→ Use fresh beans
Loud noise in grinder	Grinding degree is not suitable for coffee beans	→ Optimise grinding degree (section 3.6.)
	Foreign objects in the grinder e.g. small stones	→ Ring service hotline, ground coffee can still be prepared
Display shows Error 8 Service-Tel	Brewing unit jammed	→ Remove and clean brewing unit (section 5.5.)

In the event of a fault or an error report which you cannot correct yourself, contact your retailer or go to the service area at www.nivona.com.

An error message will appear in the display when the system identifies errors.

⚠ Attention: Make a note of the error report. Switch the appliance off and unplug it. Contact your retailer by quoting the model type, serial number (see type label fig. 1/S) and error number.

8. Spare parts/Accessories

You can buy the following spare parts and accessories from a well-stocked retailer or from our central customer service centre.

Café BERGAMO

Café MILANO

Café TORINO

Claris filter cartridge NIRF 700

Cleaning tablets NIRT 701

Descaler NIRK 703

Special cleaning agent for milk residue NICC 705

MilkCooler NICO 100

Thermo MilkCooler NICT 500

Design MilkContainer NIMC 1000

Milk tube NIMA 330

Please visit www.nivona.com to find out more about spare parts and accessories.

9. Customer service, guarantee, environmental protection

Customer service

NIVONA products are designed to meet the highest quality standards. If you still have questions regarding the use of your appliance, please drop us a line. Your support is essential to our mission to further develop and improve our products so that they fully meet your needs.

Evaporating the appliance

If you need to send back your appliance in the event of a fault, please first allow it to evaporate as follows, so that no residual water remains in the system:

- Turn the appliance on with the main switch (figure 1/H).
- First, follow the instructions on the display.
- Place a sufficiently large container (at least 0.5 l) in the middle under the outlet (figure 1/E).
- Turn the rotary to select the maintenance symbol (figure 1/C) in the main menu and then press the rotary or tap on the maintenance symbol.
- Turn the rotary to “EVAPORATING” and then press the rotary or tap on “EVAPORATING”.
- Follow the instructions on the display and then press the rotary or tap on “NEXT”.
- Follow the instructions on the display until evaporating has finished.

The appliance is now evaporated and will turn off automatically.

- Remove the drip pan and used coffee tray (figure 1/N and 1/O) and empty them both.
- Reinsert the empty water tank, drip pan and used coffee tray.

Your appliance is now ready to send.

ⓘ Information: Please pack the appliance for shipping carefully, ideally in its original packaging. We are not liable for any damage incurred during transportation.

Guarantee and customer service conditions

Please read the detailed guarantee and customer service conditions on the enclosed information sheet.

Please dispose of filter cartridges in your household waste.

Disposal of device and packaging

Please retain the packaging for your appliance. It will protect your appliance during transport if customer service support is required.

Electric and electronic devices often contain valuable and environmentally incompatible materials and should therefore not be treated as normal household waste. They can be harmful to human health and the environment if disposed of in residual waste or when handled incorrectly. Therefore, never place your potentially faulty appliance in the household waste. Instead, take it to the collection point for the disposal and recycling of electric and electronic appliances provided by your local council.

You can obtain further information from your local town hall, waste disposer or the retailer where you bought the appliance.

10. Technical data

Voltage 220–240 V AC, 50–60 Hz

Output 1455 W

Conformity mark: CE

Pump pressure static max.: 15 bar

Capacity water tank: approx. 2.2 litre

Capacity bean container: approx. 250 g

Capacity coffee grounds container max.: 11 portions

Approx. length of cable: 1.1 m

Approx. weight: 11.44 kg

Dimensions (W x H x D): 27.6 x 37.5 x 49.5 cm

NIVONA Apparate GmbH

Südwestpark 49

D-90449 Nürnberg

www.nivona.com

© 2018 by NIVONA