

Register your product and get support at
www.philips.com/welcome

02

English

INTELIA EVO

Type HD8752 / HD8881

USER MANUAL



EN

02

PLEASE READ THIS USER MANUAL CAREFULLY BEFORE USING THE MACHINE.

CE

 **Saeco**

IMPORTANT SAFEGUARDS

When using electrical appliances, basic safety precautions should always be followed, including the following:

1. Read all instructions.
2. Do not touch hot surfaces. Use handles or knobs.
3. To protect against fire, electric shock and injury to persons do not immerse cord, plugs, or appliance in water or other liquid.
4. Close supervision is necessary when the appliance is used by or near children.
5. Unplug from outlet when not in use and before cleaning. Allow to cool before putting on or taking off parts, and before cleaning the appliance.
6. Do not operate any appliance with a damaged cord or plug or after the appliance malfunctions, or has been damaged in any manner. Return appliance to the nearest authorized service facility for examination, repair or adjustment.
7. The use of accessory attachments not recommended by the appliance manufacturer may result in fire, electric shock or injury to persons.
8. Do not use outdoors.
9. Do not let cord hang over edge of table or counter, or touch hot surfaces.
10. Do not place on or near a hot gas or electric burner, or in a heated oven.
11. Always attach plug to appliance first, then plug cord into wall outlet. To disconnect, turn any control to "off", then remove plug from wall outlet.
12. Do not use appliance for other than intended use.
13. Save these instructions.

SAVE THESE INSTRUCTIONS

CAUTION

This appliance is for household use only. Any servicing, other than cleaning and user maintenance, should be performed by an authorized service center. Do not immerse machine in water. To reduce the risk of fire or electric shock, do not disassemble the machine. There are no parts inside the machine serviceable by the user. Repair should be done by authorized service personnel only.

1. Check voltage to be sure that the voltage indicated on the nameplate corresponds with your voltage.
2. Never use warm or hot water to fill the water tank. Use cold water only.
3. Keep your hands and the cord away from hot parts of the appliance during operation.
4. Never clean with scrubbing powders or harsh cleaners. Simply use a soft cloth dampened with water.
5. For optimal taste of your coffee, use purified or bottled water. Periodic descaling is still recommended every 2-3 months.
6. Do not use caramelized or flavored coffee beans.

INSTRUCTIONS FOR THE POWER SUPPLY CORD

- A. A short power-supply cord (or detachable power-supply cord) is to be provided to reduce risks resulting from becoming entangled in or tripping over a longer cord.
- B. Longer detachable power-supply cords or extension cords are available and may be used if care is exercised in their use.
- C. If a long detachable power-supply cord or extension cord is used,
 1. The marked electrical rating of the detachable power-supply cord or extension cord should be at least as great as the electrical rating of the appliance
 2. If the appliance is of the grounded type, the extension cord should be a grounding-type 3-wire cord, and
 3. The longer cord should be arranged so that it will not drape over the counter top or table top where it can be pulled on by children or tripped over.

Congratulations on your purchase of a Saeco Intelia EVO Class fully automatic coffee machine!

*To fully benefit from the support that Saeco offers, please register your product at **www.philips.com/welcome**.*

This user manual applies to HD8752 and HD8881.

The machine is made for preparing espresso coffee using whole coffee beans and for dispensing steam and hot water. In this user manual you will find all the information you need to install, use, clean and descale your machine.

CONTENTS

IMPORTANT	4
Safety Instructions.....	4
Warning.....	4
Cautions.....	6
Compliance with Standards.....	7
INSTALLATION	8
Product Overview.....	8
General Description.....	9
PREPARING FOR USE	10
Machine Packaging.....	10
Machine Installation.....	10
USING THE MACHINE FOR THE FIRST TIME	12
Circuit Priming.....	12
Automatic Rinse/Self-Cleaning Cycle.....	13
Manual Rinse Cycle.....	14
Measuring and Programming Water Hardness.....	16
"INTENZA+" Water Filter Installation.....	17
Replacing the "INTENZA+" Water Filter.....	19
ADJUSTMENTS	20
Saeco Adapting System.....	20
Adjusting the Ceramic Coffee Grinder.....	20
Adjusting the Aroma (Coffee Strength).....	21
Adjusting the Dispensing Spout.....	22
Adjusting the Coffee Length.....	23
ESPRESSO AND COFFEE BREWING	24
Espresso and Coffee Brewing Using Coffee Beans.....	24
Espresso and Coffee Brewing Using Pre-Ground Coffee.....	25
CAPPUCCINO BREWING	26
HOT WATER DISPENSING	28
CLEANING AND MAINTENANCE	30
Daily Cleaning of the Machine.....	30
Daily Cleaning of the Water Tank.....	31
Daily Cleaning of the Automatic Milk Frother.....	31
Weekly Cleaning of the Machine.....	32
Weekly Cleaning of the Brew Group.....	33
Monthly Cleaning of the Automatic Milk Frother.....	35
Monthly Lubrication of the Brew Group.....	40
Monthly Cleaning of the Brew Group with "Coffee Oil Remover".....	41
Monthly Cleaning of the Coffee Bean Hopper.....	43
DESCALING	44
PROGRAMMING	48
Adjustable Parameters.....	48
Programming Example.....	49
MEANING OF THE DISPLAY ICONS	51
TROUBLESHOOTING	54
ENERGY SAVING	56
Stand-by.....	56
Disposal.....	56
TECHNICAL SPECIFICATIONS	57
WARRANTY AND SERVICE	57
Warranty.....	57
Service.....	57
ORDERING MAINTENANCE PRODUCTS	58

IMPORTANT

Safety Instructions

This machine is equipped with safety features. Nevertheless read the safety instructions carefully and only use the machine as described in these instructions to avoid accidental injury or damage.

Keep this user manual for future reference.



The term **WARNING** and this icon warn against possible severe injuries, danger to life and/or damage to the machine.



The term **CAUTION** and this icon warn against slight injuries and/or damage to the machine.

Warning

- Connect the machine to a wall socket with a voltage matching the technical specifications of the machine.
- Do not let the power cord hang over the edge of a table or counter, or touch hot surfaces.
- Never immerse the machine, mains plug or power cord in water (danger of electrical shock).
- Never direct the hot water jet towards body parts: danger of burns!
- Do not touch hot surfaces. Use handles and knobs.
- Remove the mains plug from the wall socket:
 - If a malfunction occurs.
 - If the machine will not be used for a long time.
 - Before cleaning the machine.

Pull on the plug, not on the power cord. Do not touch the mains plug with wet hands.

- Do not use the machine if the mains plug, the power cord or the machine itself is damaged.
- Do not make any modifications to the machine or its power cord. Only have repairs carried out by a service centre authorised by Philips to avoid a hazard.
- The machine should not be used by children younger than 8 years old.
- The machine can be used by children of 8 years and upwards if they have previously been instructed on the correct use of the machine and made aware of the associated dangers or if they are supervised by an adult.
- Cleaning and maintenance should not be carried out by children unless they are more than 8 years old and supervised by an adult.
- Keep the machine and its power cord out of reach of children under 8 years old.
- The machine may be used by persons with reduced physical, sensory or mental capabilities or lacking sufficient experience and/or skills if they have previously been instructed on the correct use of the machine and made aware of the associated dangers or if they are supervised by an adult.
- Children should be supervised to ensure that they do not play with the machine.
- Never insert fingers or other objects into the coffee grinder.

Caution

- The machine is for household use only and is not intended for use in environments such as canteens, staff kitchens of shops, offices, farms or other work environments.
- Always put the machine on a flat and stable surface.
- Do not place the machine on hot surfaces, directly next to a hot oven, heater or similar source of heat.
- Only put coffee beans into the coffee bean hopper. If ground coffee, instant coffee or any other substance is put in the coffee bean hopper, it may damage the machine.
- Let the machine cool down before inserting or removing any parts.
- Never use warm or hot water to fill the water tank. Use cold non sparkling drinking water.
- Never clean with scrubbing powders or harsh cleaners. Simply use a soft cloth dampened with water.
- Descale your machine regularly. The machine indicates when descaling is needed. Not doing this will make your appliance stop working properly. In this case repair is not covered under your warranty!
- Do not keep the machine at temperature below 0 °C. Residue water in the heating system may freeze and cause damage.
- Do not leave water in the water tank when the machine is not used over a long period of time. The water can be contaminated. Use fresh water every time you use the machine.

Compliance with Standards

The machine complies with art.13 of the Italian Legislative Decree dated 25 July 2005, no. 151 "Implementation of the Directives 2005/95/EC, 2002/96/EC and 2003/108/EC on the restriction of the use of certain hazardous substances in electrical and electronic equipment, as well as waste disposal".

This machine complies with EU Directive 2002/96/EC.

This Philips appliance complies with all the applicable standards and regulations relating to the exposure to electromagnetic fields.

INSTALLATION

Product Overview

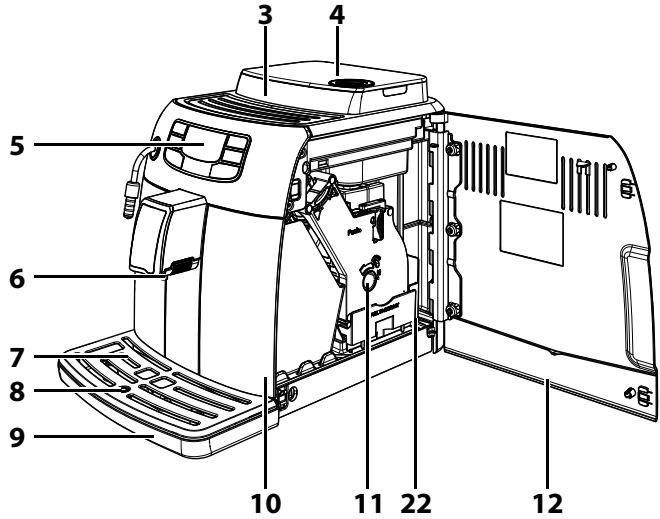
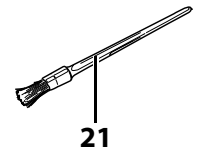
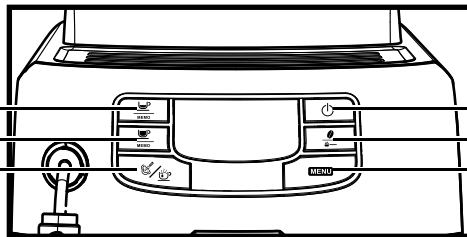
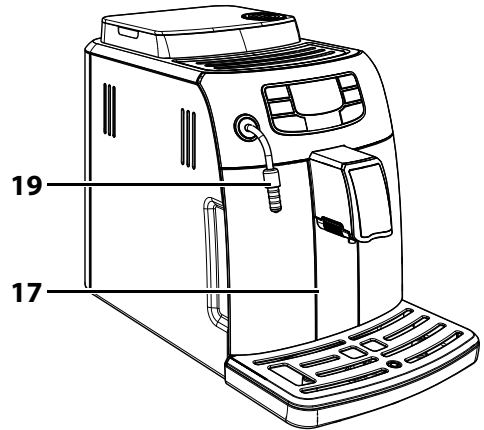
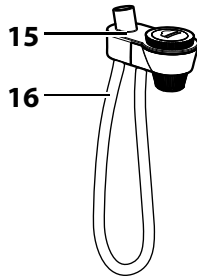
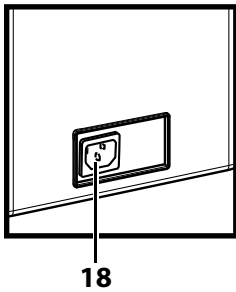
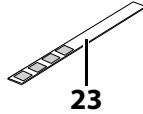
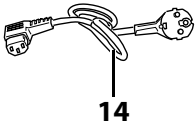
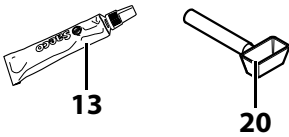
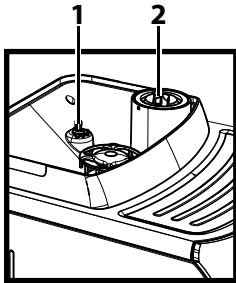

General Description

1. Grinder adjustment knob
2. Pre-ground coffee compartment
3. Coffee bean hopper
4. Coffee bean hopper lid
5. Control panel
6. Coffee dispensing spout
7. Cup holder grill
8. Full drip tray indicator
9. Drip tray
10. Coffee grounds drawer
11. Brew group
12. Service door
13. Grease for the brew group - to be purchased separately
14. Power cord
15. Automatic Milk Frother
16. Suction tube
17. Water tank
18. Power cord socket
19. Steam wand + rubber grip for Automatic Milk Frother
20. Coffee grinder adjustment key + Pre-ground coffee measuring scoop
21. Cleaning brush - to be purchased separately
22. Coffee residues drawer
23. Water hardness test strip
24. Espresso brew button
25. Coffee brew button
26. Hot water/steam selection button
27. ON/OFF button
28. "Aroma" - Pre-ground coffee button
29. "MENU" button
30. Descaling solution- to be purchased separately

PREPARING FOR USE

Machine Packaging

The original packaging has been designed and constructed to protect the machine during transport. We recommend keeping the packaging material for possible future transport.

Machine Installation

1 Remove the drip tray with grill from the packaging.

2 Remove the machine from the packaging.

3 For best use, it is recommended to:

- Choose a safe, level surface, where there will be no danger of overturning the machine or being injured.
- Choose a location that is sufficiently well-lit, clean and near an easily reachable socket.
- Allow for a minimum distance from the sides of the machine as shown in the illustration.

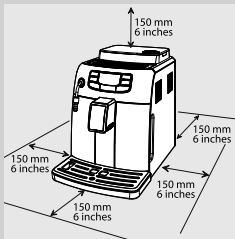

4 Insert the drip tray with grill into the machine. Make sure it is fully inserted.

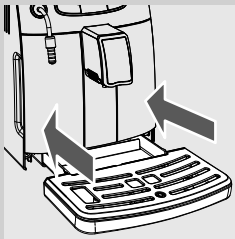

Note:

The drip tray collects the water that comes out of the dispensing spout during each rinse/self-cleaning cycle, as well as coffee that might be spilled during beverage preparation. Empty and wash the drip tray daily and each time the full drip tray indicator is raised.

Caution:

NEVER remove the drip tray when the machine has just been turned on. Wait a couple of minutes for the machine to carry out a rinse/self-cleaning cycle.

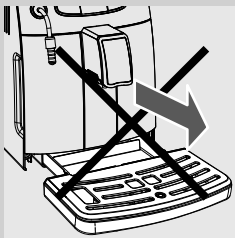

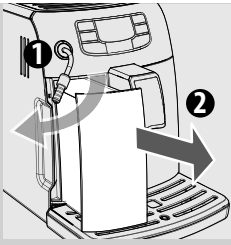

5 Remove the water tank.

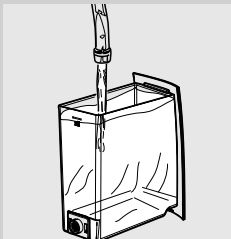

6 Rinse the water tank with fresh water.

7 Fill the water tank with fresh water up to the MAX level and reinsert it into the machine. Make sure it is fully inserted.



Caution:

Never fill the water tank with warm, hot, sparkling water or any other liquid, as this may cause damage to the water tank and the machine.

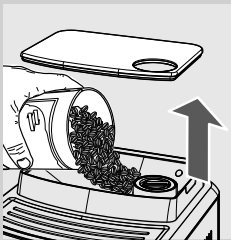

8 Remove the coffee bean hopper lid and slowly pour the coffee beans into the coffee bean hopper.



Note:

Do not pour too many coffee beans into the coffee bean hopper as this will reduce the grinding performance of the machine.



Caution:

Only coffee beans must be put into the coffee bean hopper. Ground coffee, instant coffee, caramelized coffee or any other object may damage the machine.

9 Put the lid on the coffee bean hopper.

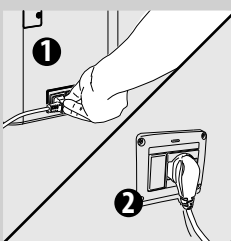

10 Insert the plug into the socket located on the back of the machine.

11 Insert the plug at the other end of the power cord into a wall socket with suitable power voltage.

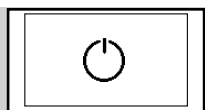

Black

12 The display shows the stand-by icon.

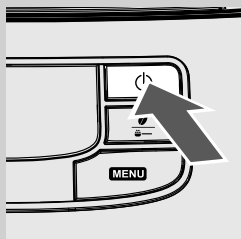

13 To turn on the machine simply press the “⏻” button. The display indicates that the circuit must be primed.

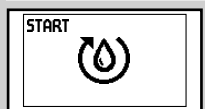

Yellow

USING THE MACHINE FOR THE FIRST TIME

When using the machine for the first time, the following activities need to happen:

- 1) You need to prime the circuit;
- 2) The machine will perform an automatic rinse/ self-cleaning cycle;
- 3) You need to initiate a manual rinse cycle.

Circuit Priming

During this process fresh water flows through the internal circuit of the machine and the machine warms up. This takes a few minutes.



1 Place a container under the steam wand.

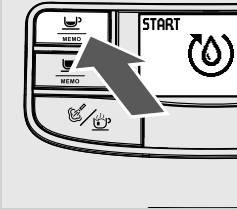

2 Press the “” button to start the cycle. The machine starts the automatic priming of the circuit by dispensing some water through the steam wand.



Yellow

3 The bar under the icon shows the operation progress. When the process is completed, the machine stops dispensing automatically.

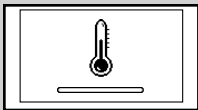

Yellow

4 Then the display shows the machine warm-up icon.

Automatic Rinse/Self-Cleaning Cycle

When warm-up is completed, the machine automatically performs a rinse/self-cleaning cycle of the internal circuit with fresh water. This takes less than a minute.



5 Place a container under the coffee dispensing spout to catch the small amount of water which will be dispensed.



Yellow

6 The machine shows this display. Wait for the cycle to finish automatically.



Note:

You can stop dispensing by pressing the “” button.

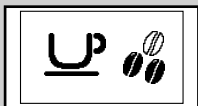

Green

7 When the above steps are complete, the machine shows this display.

Manual Rinse Cycle

During this process you activate the coffee brewing cycle and fresh water flows through the steam/hot water circuit. This takes a few minutes.



- 1 Place a container under the coffee dispensing spout.

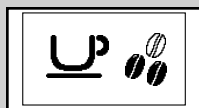

Green

- 2 Check that the machine shows this display.

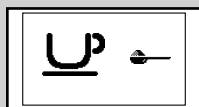

Green

- 3 Select the pre-ground coffee brewing function by pressing the “☕” button. The machine shows this display.



Note:

Do not add pre-ground coffee into the compartment.

- 4 Press the “☕ MEMO” button. The machine starts dispensing water.

- 5 When the dispensing has finished, empty the container. Repeat the operations from step 1 to step 4 twice, then continue with step 6.



- 6 Place a container under the steam wand.

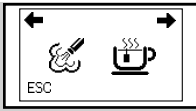

Green

7 Press the “☺/☹” button. The following icon is displayed.

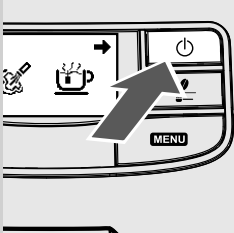

8 Press the “☹” button to start dispensing hot water.



Red

9 Dispense water until the no water icon appears.

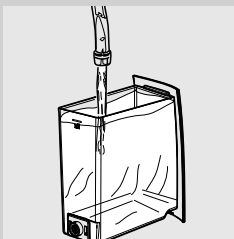

10 At the end, fill the water tank again up to the MAX level. Now the machine is ready for coffee brewing. The display to the left will be shown.

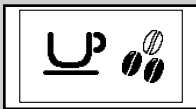

Green



Note:

When you haven't used the machine for 2 or more weeks, the machine will automatically perform an automatic rinse/self-cleaning cycle after you switch it on. Following this, you need to initiate a manual rinse cycle as described above.

The automatic rinse/self-cleaning cycle starts automatically when the machine has been in stand-by mode or turned off for more than 15 minutes. At the end of the cycle, it is possible to brew a coffee.

Measuring and Programming Water Hardness

Water hardness measuring is very important in order to define the descaling frequency and to install the "INTENZA+" water filter (for more detail on the water filter, see next chapter).

To measure the water hardness follow the steps below:

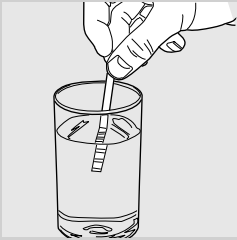

- 1** Immerse the water hardness test strip (supplied with the machine) in water for 1 second.



Note:

The test strip can only be used for one single measurement.

- 2** Wait for one minute.

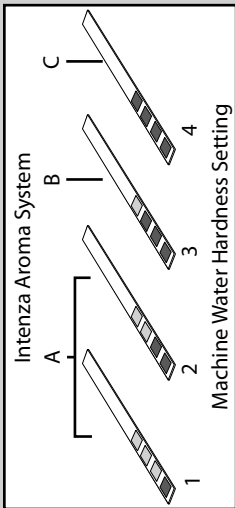

- 3** Check how many squares have changed the colour to red and then refer to the table.



Note:

The numbers on the water hardness test strip correspond to the water hardness adjustment settings.

More precisely:

- 1 = 1 (very soft water)
- 2 = 2 (soft water)
- 3 = 3 (hard water)
- 4 = 4 (very hard water)

The letters correspond to the references that are located at the base of the "INTENZA+" water filter (see next chapter).



- 4** Now you can program the water hardness setting. Press the "MENU" button and scroll the pages by pressing the "▲" button until the following icon is displayed.



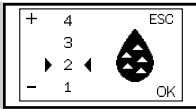

Note:

The machine is supplied with standard water hardness setting, suitable for most types of water.



Yellow

5 Press the “” button to increase the value or the “” button to decrease the value.

6 Press the “” button to confirm the setting.



Green

7 Press the “” button to exit the programming MENU. The machine shows this display and is ready to brew.

“INTENZA+” Water Filter Installation

We recommend installing the “INTENZA+” water filter as this prevents limescale build-ups and preserves a more intense aroma to your espresso coffee.



The INTENZA+ water filter can be purchased separately. Please refer to the maintenance product page in this user manual for further details. Water is a crucial part of every espresso, so it’s most important to always have it professionally filtered. Using the “INTENZA+” water filter will prevent mineral deposits from building up and improve your water quality.

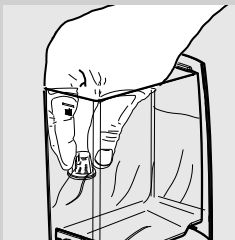

1 Remove the small white filter from the water tank and store it in a dry place.

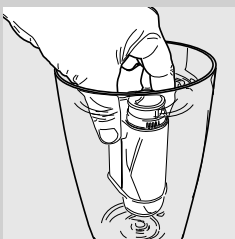

2 Remove the “INTENZA+” water filter from its packaging, immerse it vertically (with the opening positioned upwards) in cold water and gently press the sides so as to let the air bubbles out.

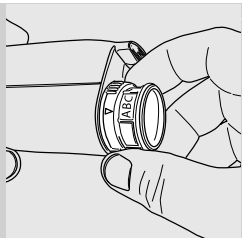

- 3** Set the filter according to the measurements performed (see previous chapter) and indicated on the base of the filter:
 A = soft water – equals 1 or 2 on the test strip
 B = hard water (standard) – equals 3 on the test strip
 C = very hard water – equals 4 on the test strip

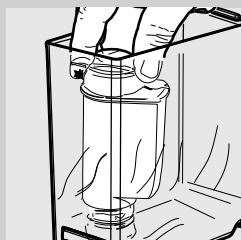

- 4** Insert the filter into the empty water tank. Press it down until it cannot move any further.
- 5** Fill the water tank with fresh water and reinsert it into the machine.
- 6** Dispense all the water of the tank by using the hot water function (see “Hot Water Dispensing” chapter).
- 7** Fill the water tank again.

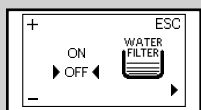

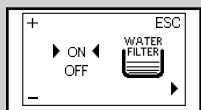

Yellow

- 8** Press the “**MENU**” button and scroll the pages by pressing the “” button until the following screen is displayed.



Yellow

- 9** Press the “” button to select “ON” and press the “” button to confirm.

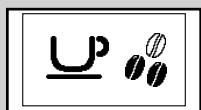

Green

- 10** To exit, press the “” button. The machine shows this display and is ready to brew.

In this way the machine has been programmed to inform the user of the need to replace the “INTENZA+” water filter.

Replacing the "INTENZA+" Water Filter

When the "INTENZA+" water filter needs to be replaced with a new one, the following icon is displayed.



Yellow

- 1 Replace the filter as described in the previous chapter.

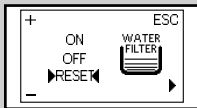

Yellow

- 2 Press the "MENU" button and scroll through the options by pressing the "☉" button until the following icon is displayed.

- 3 Select the "RESET" option. Press the "☉" button to confirm.

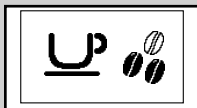

Green

- 4 To exit, press the "☉" button. The machine shows this display and is ready to brew.

The machine is now programmed to manage a new filter.



Note:

If the filter is already installed and you want to remove, but not replace it, select the "OFF" option instead.

If there is no "INTENZA+" water filter installed, insert the small white filter previously removed into the water tank.

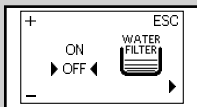

Yellow

ADJUSTMENTS

The machine allows for certain adjustments so that you can brew the best tasting coffee possible.

Saeco Adapting System

Coffee is a natural product and its characteristics may change according to its origin, blend and roast. The machine is equipped with a self-adjusting system that allows the use of all types of coffee beans available on the market (not for caramelized beans).

The machine automatically adjusts itself after brewing several cups of coffee to optimise the extraction of the coffee in relation to the compactness of the ground coffee.

Adjusting the Ceramic Coffee Grinder

Ceramic coffee grinders always guarantee accurate and perfect grinding and coarseness for every coffee speciality.

This technology provides for full aroma preservation, delivering the truly Italian taste in every cup.



Warning:

The ceramic coffee grinder contains moving parts that may be dangerous. Do not insert fingers or other objects. Only adjust the ceramic coffee grinder using the grinder adjustment key.

You can adjust the ceramic grinders to set the coffee grinding to your personal taste.



Warning:

Only turn the grinder adjustment knob inside the coffee bean hopper when the ceramic coffee grinder is in use.

This adjustment can be carried out by pressing and turning the grinder adjustment knob inside the coffee bean hopper, using the coffee grinder adjustment key provided with the machine.

Adjusting the Dispensing Spout

The height of the dispensing spout can be adjusted to better fit the dimensions of the cups that you wish to use.

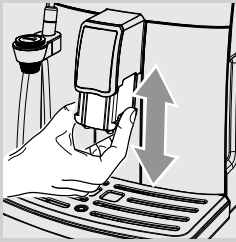

Move the dispensing spout up or down with your fingers to adjust its height as shown in the image.

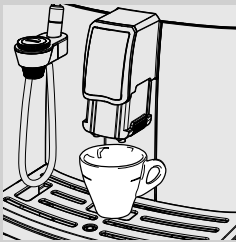

The recommended positions are:
For the use of small cups.





For the use of large cups.



Two cups can be placed under the dispensing spout to brew two coffees at the same time.

Adjusting the Coffee Length

The machine allows you to adjust the amount of brewed coffee according to your taste and/or the size of your cups.

Each time the “” or “” button is pressed, the machine brews a pre-set amount of coffee. Each button may be individually programmed for a specific brew setting.

The following procedure describes the programming of the “” button.

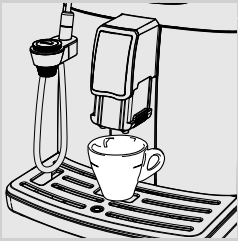

- 1 Place a cup under the dispensing spout.





Green

- 2 Press and hold the “” button until the “**MEMO**” icon is displayed. Then release the button. The machine has now entered programming mode. The machine starts brewing coffee.





Green

- 3 When the “**STOP**” icon is displayed, press the “” button as soon as the desired amount of coffee is reached.

Now the “” button is programmed; each time it is pressed, the machine will brew the same amount of espresso that was just programmed.



Note:

To program the “” brew button, the same steps should be followed. You should always use the “” button to stop brewing coffee when the desired amount of coffee is reached even when you are programming the “” brew button.

ESPRESSO AND COFFEE BREWING

Before brewing coffee, make sure that there are no warnings shown on the display, and that the water tank and coffee bean hopper are filled.

Espresso and Coffee Brewing Using Coffee Beans



- 1 Place 1 or 2 cups under the dispensing spout.



Green

- 2 To brew an espresso or a coffee, press the "☕" button to select the desired aroma.

- 3 Press the "☕ MEMO" button for an espresso or the "☕ MEMO" button for a coffee.

- 4 To brew 1 cup of espresso or coffee, press the desired button once. This icon will be displayed.

- 5 To brew 2 cups of espresso or coffee, press the desired button twice consecutively. This icon will be displayed.



Green



Note:

In this operating mode, the machine automatically grinds and doses the correct amount of coffee. Brewing two espressos or two coffee requires two grinding and brewing cycles, automatically carried out by the machine.

- 6 After the prebrewing cycle, coffee begins to pour out of the dispensing spout.

- 7 Coffee brewing stops automatically when the pre-programmed level is reached; it is, however, possible to stop earlier by pressing the "☕ MEMO" button.

Espresso and Coffee Brewing Using Pre-Ground Coffee

This function allows you to use pre-ground and decaffeinated coffee.

With the pre-ground coffee function you can only brew one coffee at a time.



Green

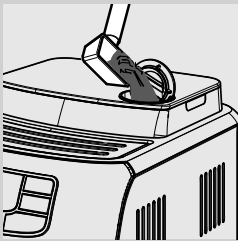



1 Press the “” button to select the pre-ground coffee function.

2 Lift the pre-ground coffee compartment lid and add one measuring scoop of pre-ground coffee to the compartment. Use only the measuring scoop supplied with the machine. Then close the pre-ground coffee compartment lid.



Warning:

Add only pre-ground coffee to the pre-ground coffee compartment. Other substances and objects may cause severe damage to the machine. Such damage will not be covered by warranty.

3 Press the “” button for an espresso or the “” button for a coffee. The brewing cycle starts.

4 After the prebrewing cycle, coffee begins to pour out of the dispensing spout.

5 Coffee brewing stops automatically when the pre-programmed level is reached; it is, however, possible to stop earlier by pressing the “” button.

After brewing the product, the machine returns to the main menu.

Repeat the steps described above to brew more coffees using pre-ground coffee.



Note:

If no pre-ground coffee is poured into the pre-ground coffee compartment, only water will be dispensed.

If the dose is excessive and 2 or more scoops of pre-ground coffee are used, the machine will not brew the product and any ground coffee will be discharged into the coffee grounds drawer.

CAPPUCCINO BREWING



Warning:

Danger of burning! Dispensing may be preceded by small jets of hot water. The Automatic Milk Frother may reach high temperatures. Never touch it with bare hands. Use the appropriate protective handle only.

- 1 Fill 1/3 of a container with cold milk.



Note:

Use cold (~5°C / 41°F) milk with a protein content of at least 3% to ensure optimum results when preparing a cappuccino. Whole milk or skimmed milk may be used depending on individual taste.



Notes:

When you plan to dispense steam right after switching on the machine or after brewing a coffee, some water still present in the circuit may need to be dispensed first.

For this press the "☕/☕" button and then the "MEMO" button to dispense steam for a few seconds. Thereafter press the "MEMO" button to stop dispensing. Then continue with step 2.

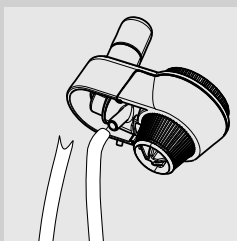

- 2 Insert the suction tube into the Automatic Milk Frother.

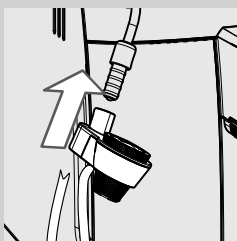

- 3 Insert the Automatic Milk Frother until it locks in place in the steam wand seat.

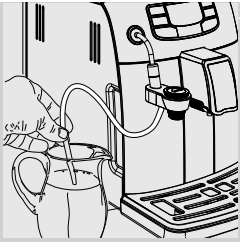

4 Insert the suction tube into the milk container.

! **Caution:**
for hygienic reasons, make sure that the suction tube is clean on the outside.

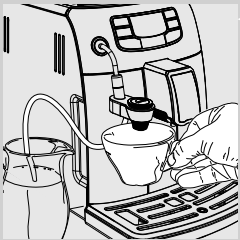

5 Place a cup under the Automatic Milk Frother.



Green

6 Press the "☞☞" button. The following icon is displayed. Press the "☞☞" button to start dispensing steam.

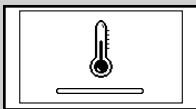

Yellow

7 This icon is displayed during preheating time required by the machine.



Green

8 When this icon is displayed, the machine dispenses frothed milk directly in the cup.

9 Press the "☞☞" button to stop dispensing.

10 Place the milk container back in the fridge for correct storage.

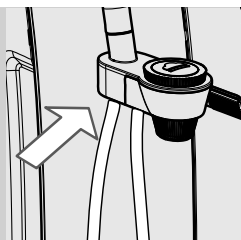

11 After use, store the suction tube as shown in the figure.

Note:

After having pressed the “” button it will take a few seconds before the machine stops dispensing steam completely.

Caution:

After frothing the milk, a small quantity of hot water must be dispensed into a container. See chapter “Daily Cleaning of the Automatic Milk Frother” for detailed cleaning instructions.

Note:

After dispensing steam, it is possible to brew an espresso or dispense hot water straight after.

HOT WATER DISPENSING

Warning:

Danger of burning! Dispensing may be preceded by small jets of hot water. The Automatic Milk Frother may reach high temperatures. Never touch it with bare hands. Use the appropriate protective handle only.

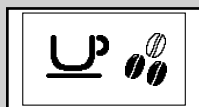

Green

Before dispensing hot water, make sure that the machine is ready to use and the water tank is filled.

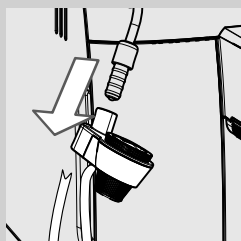

1 Remove the Automatic Milk Frother as shown in the figure.

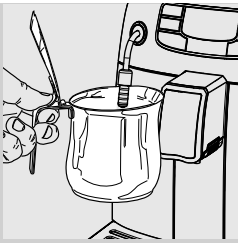

2 Place a container under the steam wand.



3 Press the “” button. The following icon is displayed.

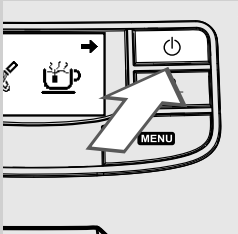

4 Press the “” button to start dispensing hot water.

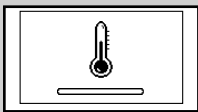

5 This icon is displayed during preheating time required by the machine.



6 Pour the desired amount of hot water. To stop the hot water dispensing, press the “” button.

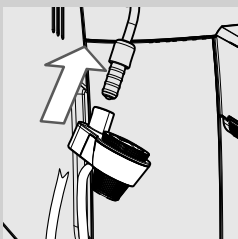

7 Insert the Automatic Milk Frother until it locks in place in the steam wand seat.

CLEANING AND MAINTENANCE

Daily Cleaning of the Machine.



Caution:

Timely cleaning and maintenance of your machine is very important as it prolongs the life of your machine. Your machine is continuously exposed to moisture, coffee and limescale!

The activities you need to perform and their frequency are described in detail in this chapter. Not doing this will ultimately make your machine stop working properly. This repair is NOT covered by your warranty!



Note:

- Use a soft, dampened cloth to clean the machine.
- Do not wash any removable part in the dishwasher.
- Do not immerse the machine in water.
- Do not use alcohol, solvents, and/or abrasive objects to clean the machine.
- Do not dry the machine and/or its components using a microwave and/or standard oven.

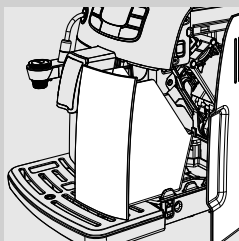

- 1** Empty and clean the coffee grounds drawer daily with the machine turned on.

Other maintenance operations can only be carried out when the machine is turned off and unplugged.

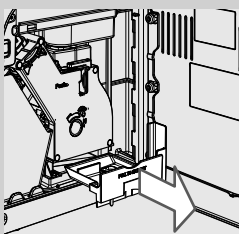

- 2** Empty and clean the coffee residues drawer located inside of the machine. Open the service door, remove the coffee residues drawer and empty the coffee grounds.

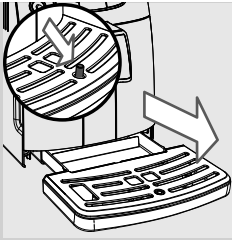

- 3 Empty and clean the drip tray. Perform this operation also when the full drip tray indicator is raised.

Daily Cleaning of the Water Tank

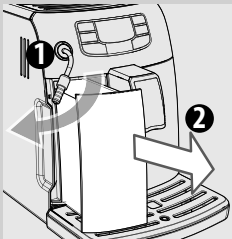

- 1 Remove the small white filter or the INTENZA+ water filter (if installed) from the water tank and wash the tank with fresh water.
- 2 Put the small white filter back or the INTENZA+ water filter (if installed) in its housing by gently pressing and turning it at the same time.
- 3 Fill the water tank with fresh water.

Daily Cleaning of the Automatic Milk Frother

For hygienic reasons and to ensure a perfect milk froth consistency, it is important that the Automatic Milk Frother be cleaned daily or after each use.

After each milk frothing you always need to:

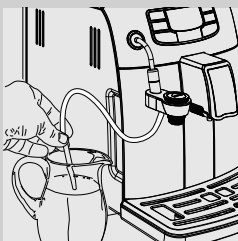

- 1 Insert the suction tube in a container filled with fresh water.



- 2 Place an empty container under the Automatic Milk Frother.

Weekly Cleaning of the Brew Group

The brew group should be cleaned every time the coffee bean hopper is filled or at least once a week.

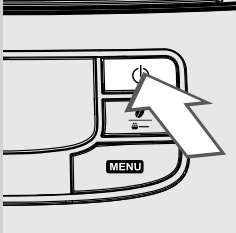

- 1 Turn off the machine by pressing the "⏻" button and remove the plug from the socket.

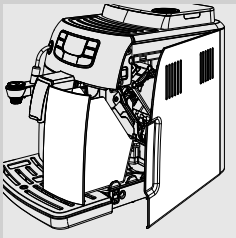

- 2 Remove the coffee grounds drawer. Open the service door.

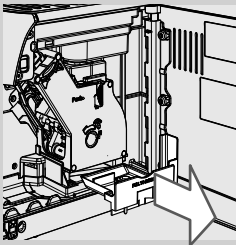

- 3 Remove and clean the coffee residues drawer.

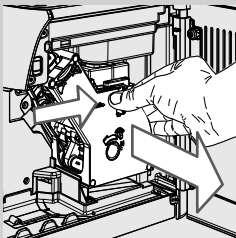

- 4 To remove the brew group, press the «PUSH» button and pull it by the handle.

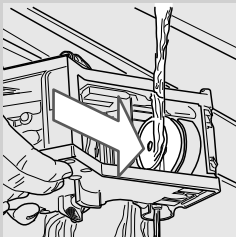

- 5 Thoroughly wash the brew group with fresh, lukewarm water and carefully clean the upper filter.



Caution:

Do not use detergent or soap to clean the brew group.

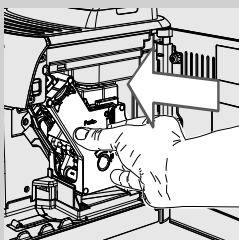
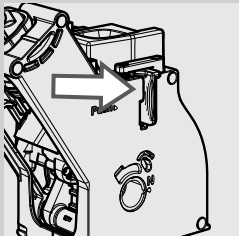
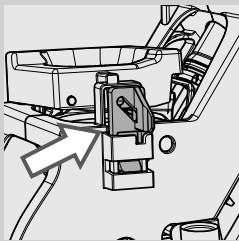
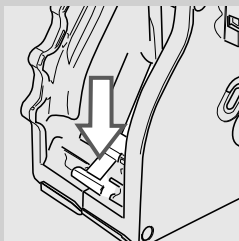
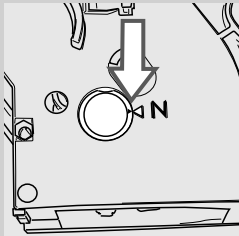

6 Let the brew group air-dry thoroughly.

7 Thoroughly clean the inside of the machine using a soft, dampened cloth.

8 Make sure the brew group is in the off position; the two reference signs must match. If they do not match up, proceed as described in steps 9-10.

9 Gently pull down the lever until it is in contact with the brew group base and the two reference signs on the side of the brew group match.

10 Make sure the hook to lock the brew group is in the correct position by firmly pressing the "PUSH" button until it locks into place. Check if the hook is at the top end position. If it is not, please try again.

11 Insert the brew group in its seat again until it locks into place without pressing the "PUSH" button.

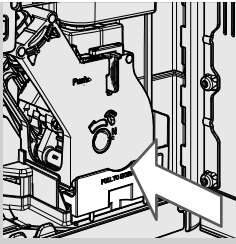

12 Insert the coffee residues drawer and close the service door.

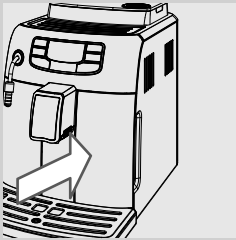

13 Insert the coffee grounds drawer.

Monthly Cleaning of the Automatic Milk Frother

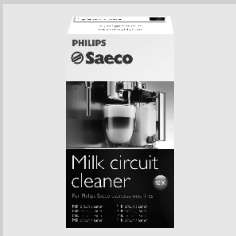

Every month you need to perform a more thorough cleaning of the Automatic Milk Frother using the "Saeco Milk Circuit Cleaner". The "Saeco Milk Circuit Cleaner" can be purchased separately. Please refer to the maintenance product page in this user manual for further details.

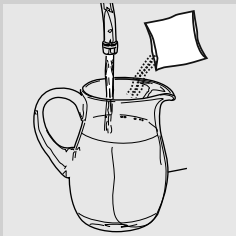

1 Make sure that the Automatic Milk Frother is correctly installed.

2 Pour the milk circuit cleaner into a container. Add ½ litre of lukewarm water and wait for the product to dissolve completely.

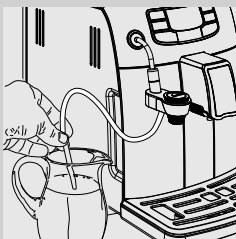

3 Insert the suction tube into the container.

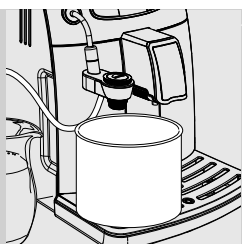

4 Place a large container (1.5l) under the Automatic Milk Frother.



Green

5 Press the “” button. This icon will be displayed.

6 Press the “” button to dispense steam.

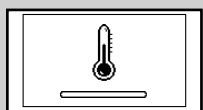

Yellow

7 This icon is displayed during preheating time required by the machine.



Green

8 The following icon will be displayed during dispensing. When the solution is finished, press the “” button to stop dispensing.



Warning:

Never drink the solution dispensed during this step.

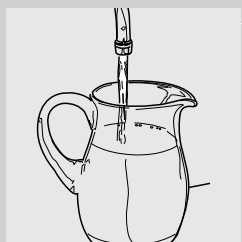

9 Rinse the container thoroughly and fill it with ½ litre of fresh water to be used for the rinse cycle.

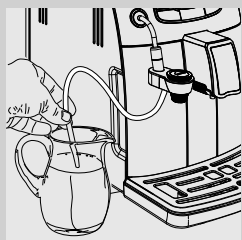

10 Insert the suction tube into the container.

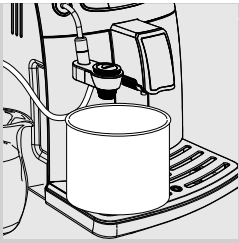

11 Empty the container and place it back under the Automatic Milk Frother.



Green

12 Press the “” button. This icon will be displayed.

13 Press the “” button to dispense steam.

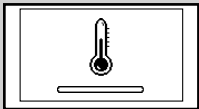

Yellow

14 This icon is displayed during preheating time required by the machine.



Green

15 The following icon will be displayed during dispensing. When the water is finished, press the “” button to stop dispensing.

16 Wash all the Automatic Milk Frother components by following the instructions below.

17 Remove the Automatic Milk Frother from the machine.

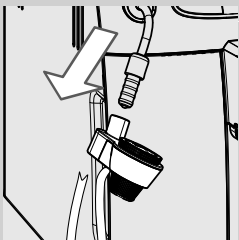

18 Remove the rubber grip from the steam wand.

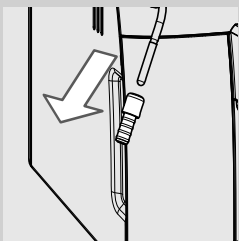

Caution:

The steam wand may be hot if the same has been recently used.

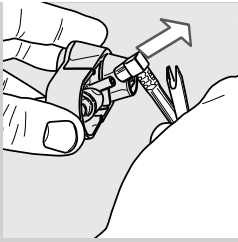

19 Remove the suction tube.

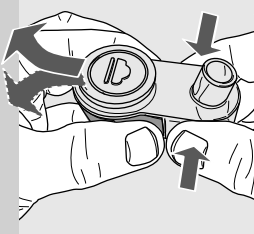

20 To detach the Automatic Milk Frother, press the sides and remove it by applying light lateral movements as shown in the figure.

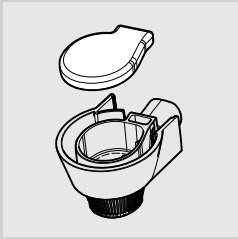

21 Remove the rubber lid as shown in the figure.

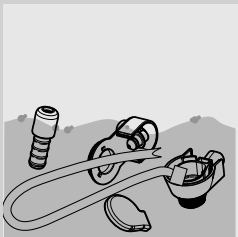

22 Wash all the components with lukewarm water.

 **Note:**

These components can also be put into the dishwasher for cleaning.

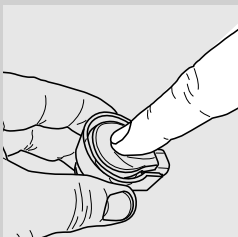

23 Attach the lid by pressing in the middle, and ensure that it is firmly in place.

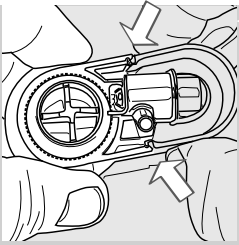

24 Attach the Automatic Milk Frother to the fitting and ensure it is locked into place in its seat.

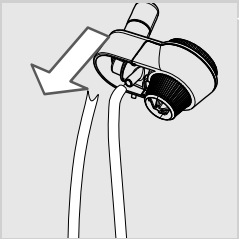

25 Install the suction tube.

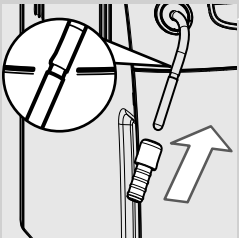

26 Insert the rubber grip back on the steam wand.

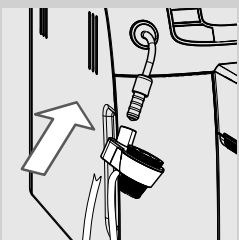

27 Insert the Automatic Milk Frother on the rubber grip until it locks into place.



Caution:

Do not insert the rubber grip further than the seat shown. In this case, the Automatic Milk Frother would not function correctly as it would not be able to draw up milk.

Monthly Lubrication of the Brew Group

Lubricate the brew group after approximately 500 cups of coffee or once a month.

You can purchase the Saeco grease, used to lubricate the brew group, separately. Please refer to the maintenance product page in this user manual for further details.

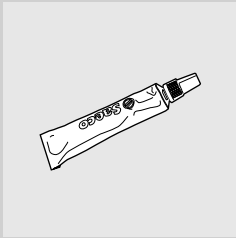

Caution:

Before lubricating the brew group, clean it with fresh water and let it dry, as described in the “Weekly Cleaning of the Brew Group” chapter.

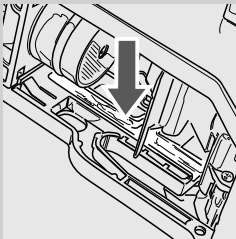

- 1 Apply the grease evenly on both side guides.

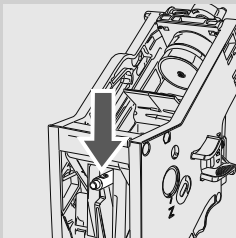
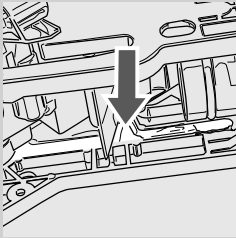

- 2 Also lubricate the shaft.

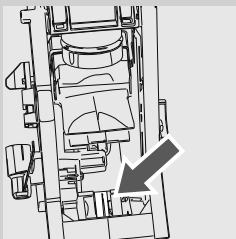

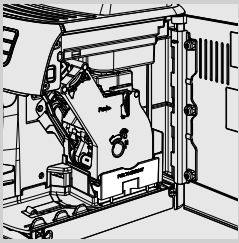

3 Insert the brew group in its seat until it locks into place (see “Weekly Cleaning of the Brew Group” chapter). Insert the coffee residues drawer.

4 Close the service door. Insert the coffee grounds drawer.

Monthly Cleaning of the Brew Group with “Coffee Oil Remover”



Besides weekly cleaning, we recommend running the cleaning cycle with “Coffee Oil Remover” after approximately 500 cups of coffee or once a month. This operation completes the maintenance process for the brew group.

You can purchase separately the “Coffee Oil Remover”. Please refer to the maintenance product page in this user manual for further details.



Caution:

The “Coffee Oil Remover” tablets are to be used for cleaning only and do not have a descaling function. For the descaling procedure use the Saeco descaling solution and follow the procedure described in the “Descaling” chapter.



1 Place a container under the dispensing spout.

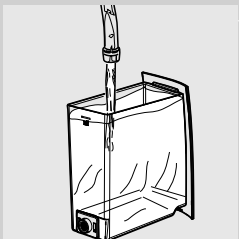

2 Make sure the water tank is filled with fresh water up to the “MAX” level.

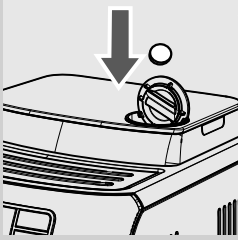

Green

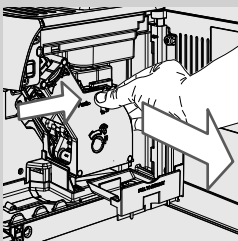
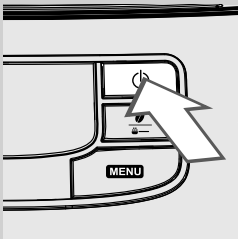
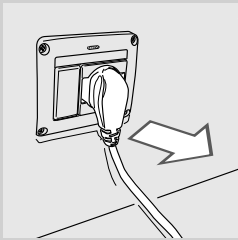

3 Put a “Coffee Oil Remover” tablet in the pre-ground coffee compartment.

4 Press the “☕/—” button one or more times to select the pre-ground coffee function without adding ground coffee to the compartment.

5 Press the “☕
MENU” button to start a coffee brewing cycle.

6 Wait until the machine has dispensed half a cup of water.

7 Remove the plug of the power cord from the wall socket.

8 Let the solution take effect for approximately 15 minutes. Make sure you discard the dispensed water.

9 Reinsert the plug of the power cord into the wall socket. Turn on the machine by pressing the “☕” button. Wait for the automatic rinse cycle to be completed.

10 Remove the coffee grounds drawer and open the service door. Remove the coffee residues drawer and then the brew group.

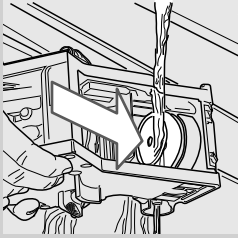

11 Wash the brew group thoroughly with fresh water.

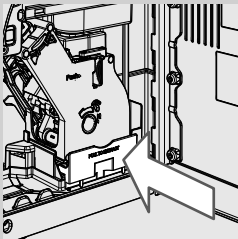

12 After rinsing the brew group, insert it again in its seat until it locks into place (see “Weekly Cleaning of the Brew Group” chapter). Insert the coffee residues drawer and the coffee grounds drawer. Close the service door.



Green

13 Press the “☕” button to select the pre-ground coffee function without adding ground coffee to the compartment.

14 Press the “MEMO ☕” button to start a coffee brewing cycle.

15 Repeat steps 13 to 14 twice. Make sure you discard the dispensed water.

16 To clean the drip tray, place “Coffee Oil Remover” tablet inside and fill it 2/3rds full with hot water. Let the cleaning solution take effect for about 30 minutes, then rinse thoroughly.

Monthly Cleaning of the Coffee Bean Hopper

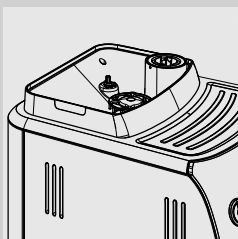

Clean the coffee bean hopper once a month when it is empty with a damp cloth to remove coffee oil. Thereafter refill it with coffee beans.

DESCALING



Yellow

The descaling process takes approx. 35 minutes. Limescale builds up inside the machine during use. It needs to be removed regularly as it may clog the water and coffee circuit of your machine. The machine indicates when descaling is needed. Descaling is required when the machine display shows the CALC CLEAN icon.

**Caution:**

Not doing this will ultimately make your machine stop working properly, and in this case repairing is NOT covered by your warranty.



Always use Saeco descaling product only, since it has been designed to optimize machine performance.

You can purchase separately the SAECO descaling solution. Please refer to the maintenance product page in this user manual for further details.

**Warning:**

Never drink the descaling solution or any products dispensed until the cycle has been carried out to the end. Never use vinegar as a descaling solution.

**Note:**

Do not turn off the machine during the descaling cycle. Otherwise you will need to restart the descaling cycle from the very beginning.

To execute the descaling cycle, follow the steps below:

Before descaling:

- 1** Empty the drip tray.

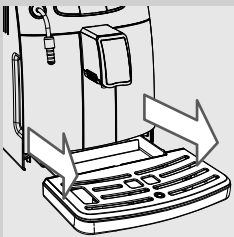

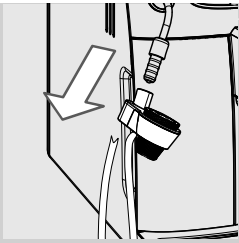

2 Remove the Automatic Milk Frother from the steam/hot water wand.



Yellow

3 Remove the "INTENZA+" water filter (if supplied) from the water tank if it was installed.

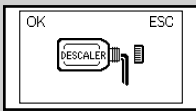

Red

4 Press the "MENU" button. Press the "☉" button until the following display is shown.

5 Press the "☉ MEMO" button to enter the descaling menu.



Note:

If you press the "☉ MEMO" button by mistake, press the "⏻" button to quit.

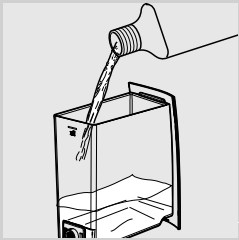

6 Remove the water tank and pour the entire content of the Saeco descaling solution. Fill the water tank with fresh water up to the MAX level.

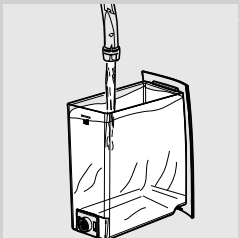

7 Place the water tank back into the machine.



8 Place a large container (1.5l) under the steam/hot water wand and the dispensing spout.

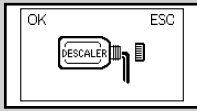

Red



9 Press the “” button to start the descaling cycle.



Red

10 The machine will start dispensing the descaling solution at regular intervals. The bar on the display shows the cycle progress.

 **Note:**

The descaling cycle may be paused by pressing the “” button. To resume the cycle, press the “” button again. This allows you to empty the container or to leave the machine unattended for a short time.



Red



Red

11 When this icon is displayed, the water tank is empty.

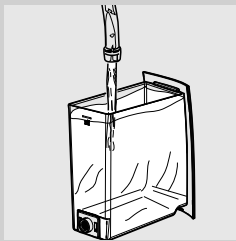

12 Remove the water tank, rinse it and fill it up to the MAX level with fresh water. Place it back into the machine.

13 Empty the drip tray and place it back.

14 Empty the container and place it back under both the steam/hot water wand and the dispensing spout.



Red

15 When inserting the water tank into the machine, this icon is displayed. Press the “” button to start the rinse cycle.



Red

16 When this icon is displayed, the water tank is empty. Repeat steps 12 to 15. Then continue with step 17.

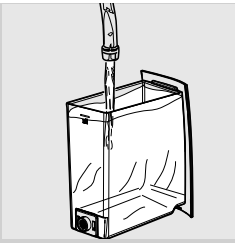

17 When the water tank is empty, remove it, rinse it and fill it up to the MAX level with fresh water. Place it back into the machine.

18 Empty the container and place it back under the dispensing spout.

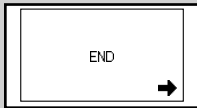

Red

19 When the amount of water needed for the rinse cycle has been completely dispensed, this icon on the side is displayed. Press the "☉" button to quit the descaling cycle.



Yellow

20 The machine automatically primes the circuit.

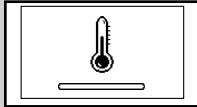

Yellow

21 The machine now carries out the warm-up and automatic rinse cycle to prepare for product brewing.

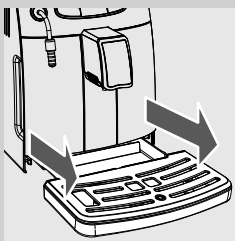

22 Empty the drip tray and place it back.

23 Remove and empty the container.

24 The descaling cycle is now complete.

25 Place the "INTENZA+" water filter (if fitted) back in the water tank and reinsert the Automatic Milk Frother.



Note:

At the end of the descaling cycle, wash the brew group as described in the "Weekly Cleaning of the Brew Group" chapter.

The two rinse cycles are performed in order to have the circuit cleaned with a pre-set amount of water to ensure proper machine performance. If the water tank is not filled up to MAX level, the machine might require three or more cycles.

PROGRAMMING

The user can change some of the machine operating parameters to suit his/her needs.

Adjustable Parameters

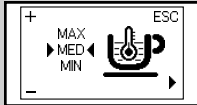

Yellow

Coffee Temperature

This function adjusts the coffee brewing temperature.

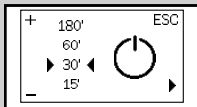

Yellow

Timer (stand-by)

This function adjusts the time taken for the machine to go into stand-by mode after the last brewing.

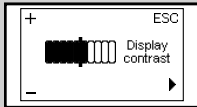

Yellow

Contrast

This function allows you to adjust the contrast of the display to better view the messages.

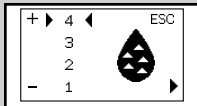

Yellow

Water Hardness

This function adjusts the water hardness setting according to the area where you live.

- 1 = very soft water
- 2 = soft water
- 3 = hard water
- 4 = very hard water

For more details, please see the "Measuring and Programming Water Hardness" chapter.

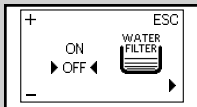

Yellow

"INTENZA+" Water Filter

This function manages the "INTENZA+" water filter. For more details, see the chapter about filter handling.

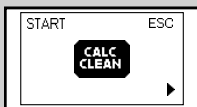

Yellow

Descaling cycle

This function activates the descaling cycle.

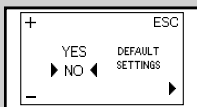

Yellow

Factory Settings

This function allows you to reset all factory values.

Programming Example

In this example, it is shown how to program the display contrast. Proceed in the same way to program the other functions.

The programming menu can only be accessed when the machine is on and shows this display.

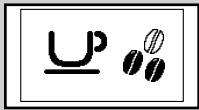

Green

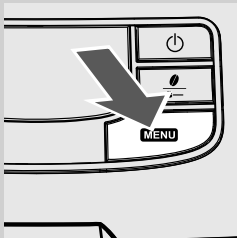

- 1 Press the "MENU" button to access programming.

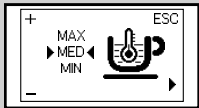

Yellow

- 2 The first page is displayed.

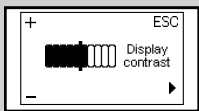
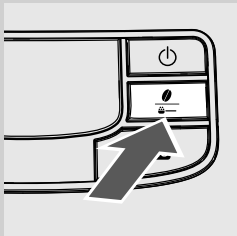

Yellow

- 3 Press the "☿" button to scroll the functions pages until the display contrast function is displayed.

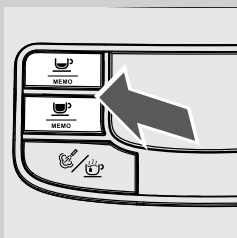

- 4 Press the "☿ MEMO" and "☿ MEMO" buttons to increase or decrease the value of the function.

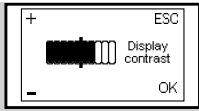

Yellow

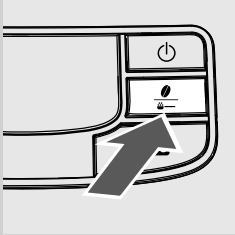

- 5 When the display value is changed, the "OK" message appears. Press the "OK" button to confirm the change.

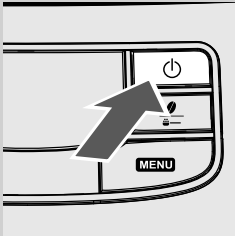

- 6 Press the "Power" button to exit the programming menu.

 **Note:**

The machine will exit the programming mode if the user does not do anything for 3 minutes. The values that have been changed but not confirmed won't be saved.

MEANING OF THE DISPLAY ICONS

This machine is equipped with a colour-coded system to make the user's understanding of the display signals easier. The icons are colour-coded according to the traffic light principle.

Ready Signals (Green Colour)

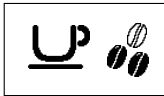

The machine is ready to brew products.

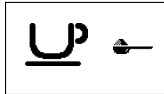

The machine is ready to brew pre-ground coffee.

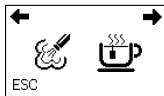

Steam or hot water selection.



Hot water dispensing.



Steam dispensing.

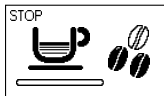

The machine is brewing one cup of espresso.

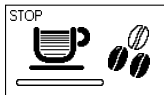

The machine is brewing one cup of coffee.



The machine is brewing two cups of espresso.

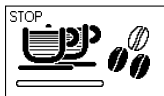

The machine is brewing two cups of coffee.

Ready Signals (Green Colour)



The machine is programming the amount of coffee to be brewed.

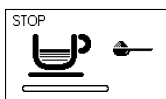

Coffee brewing using pre-ground coffee in progress.

Warning Signals (Yellow Colour)

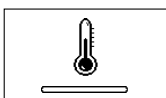

The machine is in warm-up phase to brew beverages or dispense hot water.

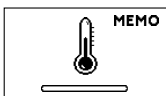

The machine is in warm-up phase during beverages programming.



The machine is performing the rinse phase. Wait until the machine has completed the cycle.

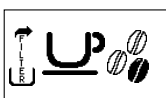

The machine needs the "INTENZA+" water filter to be replaced.



The brew group is being reset due to machine reset.

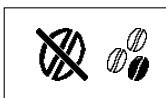

Refill the coffee bean hopper with coffee beans and restart the cycle.

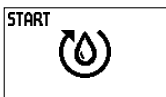

Prime the circuit.



The machine needs to be descaled. Press the "MEMO" button to enter the descaling menu. Follow the steps described in the descaling chapter of this manual. If you want to descale later, press the "power" button to continue using the machine.

Please note that not descaling your machine will ultimately make it stop working properly. In this case repair is NOT covered under your warranty.

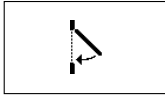
Warning Signals (Red Colour)

Close the service door.



Fill the coffee bean hopper.

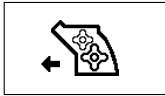

The brew group must be inserted into the machine.

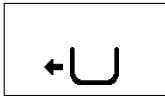

Insert the coffee grounds drawer.

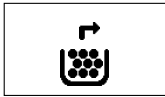

Empty the coffee grounds drawer and the coffee residues drawer.

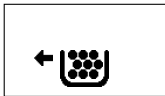

Fully insert the coffee grounds drawer before turning the machine off.



Fill the water tank.

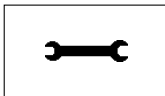

Turn off the machine. Turn it back on after 30 seconds. Try this 2 or 3 times. If the machine does not start, contact the Philips SAECO hotline in your country. The contact details can be found in the warranty booklet packed separately or on www.philips.com/support.

TROUBLESHOOTING

This chapter summarizes the most common problems you could encounter with your machine.

If you are unable to solve the problem with the information below, visit www.philips.com/support for a list of frequently asked questions or contact the Philips Saeco hotline in your country.

The contact details can be found in the warranty booklet packed separately or on www.philips.com/support.

Machine actions	Causes	Solutions
The machine does not turn on.	The machine is not connected to the electric network.	Connect the machine to the electric network.
The drip tray gets filled although no water is drained.	Sometimes water is drained automatically by the machine into the drip tray to manage the rinsing of the circuits and ensure optimum machine performance.	This is a standard operating procedure.
The red  icon is always displayed on the machine.	The coffee grounds drawer was emptied with the machine off.	The coffee grounds drawer must always be emptied with the machine on. Wait until the  icon is displayed before refitting the drawer.
Coffee is not hot enough.	The cups are cold.	Preheat the cups with hot water.
No hot water or steam is dispensed.	The hole of the steam wand is clogged.	Clean the hole of the steam wand using a pin. Make sure that the machine is off and has cooled down before performing this operation.
	Automatic Milk Frother is dirty (if supplied).	Clean the Automatic Milk Frother.
Coffee does not have enough crema. (See note)	The blend is unsuitable, coffee is not freshly roasted or the grind is too coarse.	Change coffee blend or adjust the grind as explained in the section "Adjusting the Ceramic Coffee Grinder".
The machine takes a long time to warm up or the amount of water dispensed from the wand is too little.	The machine circuit is clogged by limescale.	Descalcify the machine.
The brew group cannot be removed.	The brew group is out of place.	Turn on the machine. Close the service door. The brew group automatically returns to the initial position.
	The coffee grounds drawer is inserted.	Remove the coffee grounds drawer before removing the brew group.
There is a lot of ground coffee under the brew group.	Coffee is not suitable for automatic machines.	It may be necessary to change the type of coffee or the coffee grinder settings.

Machine actions	Causes	Solutions
The machine grinds the coffee beans but no coffee comes out. (See note)	There is no water.	Fill the water tank and prime the circuit (see "Using the Machine for the First Time" chapter).
	The brew group is dirty.	Clean the brew group (see the "Weekly Cleaning of the Brew Group" chapter).
	The circuit is not primed.	Prime the circuit (see "Using the Machine for the First Time" chapter).
	This might occur when the machine is automatically adjusting the dose.	Brew a few cups of coffee as described in the "Saeco Adapting System" chapter.
	The dispensing spout is dirty.	Clean the dispensing spout.
Coffee is too weak. (See note)	This might occur when the machine is automatically adjusting the dose.	Brew a few cups of coffee as described in the "Saeco Adapting System" chapter.
Coffee is brewed slowly. (See note)	The coffee grind is too fine.	Change coffee blend or adjust the grind as explained in chapter "Adjusting the Ceramic Coffee Grinder".
	The circuit is not primed.	Prime the circuit (see "Using the Machine for the First Time" chapter).
	The brew group is dirty.	Clean the brew group (see the "Weekly Cleaning of the Brew Group" chapter).
Coffee leaks out of the dispensing spout.	The dispensing spout is clogged.	Clean the dispensing spout and its holes.
Milk does not froth.	The Automatic Milk Frother is inserted too deep. No milk is being suctioned.	Leave the Automatic Milk Frother to cool down. Move it slightly downwards. Reposition it in its correct seat.
Frothed milk is too cold.	The cups are cold.	Preheat the cups with hot water.

**Note:**

These problems can be considered normal if the coffee blend has been changed or if the machine has just been installed. In this case wait until the machine performs a self-adjusting operation as described in "Saeco Adapting System" chapter.

ENERGY SAVING

Stand-by

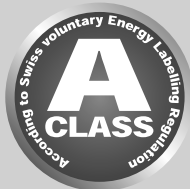

Black

The Saeco fully automatic espresso machine is designed for energy saving proven by the Class A energy label.

After 30 minutes of inactivity, the machine turns off automatically. If a product has been brewed the machine performs a rinse cycle.

In stand-by mode, the energy consumption is below 1Wh.

To turn on the machine, press the "⏻" button (if the power button on the back of the machine is set to "I"). If the boiler is cold the machine performs a rinse cycle.

Disposal



Do not throw away the machine with the normal household waste at the end of its life, but hand it in at an official collection point for recycling. By doing this, you help to preserve the environment.

- Packaging materials can be recycled.
- Machine: unplug the machine and cut the power cord.
- Deliver the appliance and power cord to a service centre or public waste disposal facility.

This product complies with EU Directive 2002/96/EC.

The symbol on the product or on its packaging indicates that this product may not be treated as household waste. Instead, it shall be handed over to the applicable collection point for the recycling of electrical and electronic equipment.

By ensuring this product is disposed of correctly, you will help prevent potential negative consequences for the environment and human health, which could otherwise be caused by inappropriate waste handling of this product. For more detailed information about recycling of this product, please contact your local city office, your household waste disposal service or the shop where you purchased the product.

TECHNICAL SPECIFICATIONS

The manufacturer reserves the right to make changes to the technical specifications of the product.

Nominal Voltage - Power Rating - Power Supply	See label on the inside of the service door
Housing material	Thermoplastic material
Size (w x h x d)	265.5 x 341 x 449 mm
Weight	9 kg
Control panel	Front panel
Automatic Milk Frother	Special for cappuccino
Cup size	110 mm
Water tank	1.5 litres - Removable type
Coffee bean hopper capacity	300 g
Coffee grounds drawer capacity	10
Pump pressure	15 bar
Boiler	Stainless steel type
Safety devices	Thermal fuse

WARRANTY AND SERVICE

Warranty

For detailed information on your warranty and related conditions, please read the warranty booklet supplied separately.

Service

We want to ensure that you remain satisfied with your machine. If not done already, please register your purchase at www.philips.com/welcome. This will enable us to stay in contact with you and send you cleaning and descaling reminders.

If you need service or support, please visit the Philips website at www.philips.com/support or contact the Philips Saeco hotline in your country. The contact number can be found in the warranty booklet packed separately or on www.philips.com/support.

ORDERING MAINTENANCE PRODUCTS

For cleaning and descaling, use Saeco maintenance products only. You can purchase the products at the Philips online shop (if available in your country) at www.shop.philips.com/service, from your local dealer or authorised service centres.

If you have any difficulties obtaining maintenance products for your machine, please contact the Philips Saeco hotline in your country.

The contact details can be found in the warranty booklet packed separately or on www.philips.com/support.

Overview of maintenance products



- Descaling solution CA6700



- Intenza+ water filter CA6702

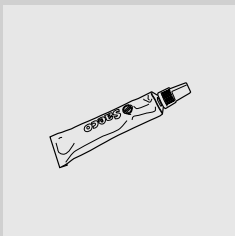

- Grease HD5061



- Coffee Oil Remover CA6704

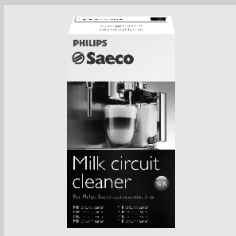

- Milk Circuit Cleaner: CA6705



- Maintenance Kit CA 6706

02

Rev.00 del 15-11-13



421946007621

EN

02

The manufacturer reserves the right to make changes without prior notice.



www.philips.com/saeco