



J8 (EA/SA/INTA)

Instructions for Use



Additional online content

Tap, click or scan the QR code to access additional online resources.

There are video tutorials to help you operate your J8.



jura.com/support-j8

Table of contents

1	Control elements	3
2	For your safety	4
	Comply with the instructions for use	4
	Proper use	4
	User limitations	4
	Use by children	4
	What to do in the event of damage	4
	Preventing damage	5
	Danger of electric shock	5
	Danger of burns, scalding and injury	5
3	Preparing and using for the first time	6
	Setting up the machine	6
	Filling the bean container	6
	Determining the water hardness	6
	First-time use	6
	Managing your J8 – the JURA Cockpit	8
	Coffee Eye	8
	Connecting milk	8
	Establishing a WiFi connection	9
4	Preparation	9
	Preparation with preselection (Speciality Selection)	9
	Espresso and coffee	9
	Sweet latte (prepared with syrup attachment)	10
	Latte macchiato, cappuccino and other speciality coffees with milk	11
	Milk and milk foam	11
	Americano and lungo	11
	Espresso doppio	11
	Ground coffee	11
	Hot water	12
	Adjusting the product settings	12
5	Daily operation	13
	Switching the machine on and off	13
	Filling the water tank	13
	Maintenance actions	14
6	Machine settings	14
7	Maintenance	15
	Rinsing the machine	15
	Rinsing the milk system	15
	Cleaning the milk system	16
	Dismantling and rinsing the professional fine foam frother	16
	Inserting/changing the filter	17
	Cleaning the machine	18
	Descaling the machine	19
	Descaling the water tank	20
	Cleaning the bean container	20
8	Display messages	21
9	Troubleshooting	21
10	Transport and environmentally friendly disposal	22
	Transport / Emptying the system	22
	Disposal	22
11	Technical data	23
12	Index	24
13	JURA contact details / Legal information	26

1 Control elements

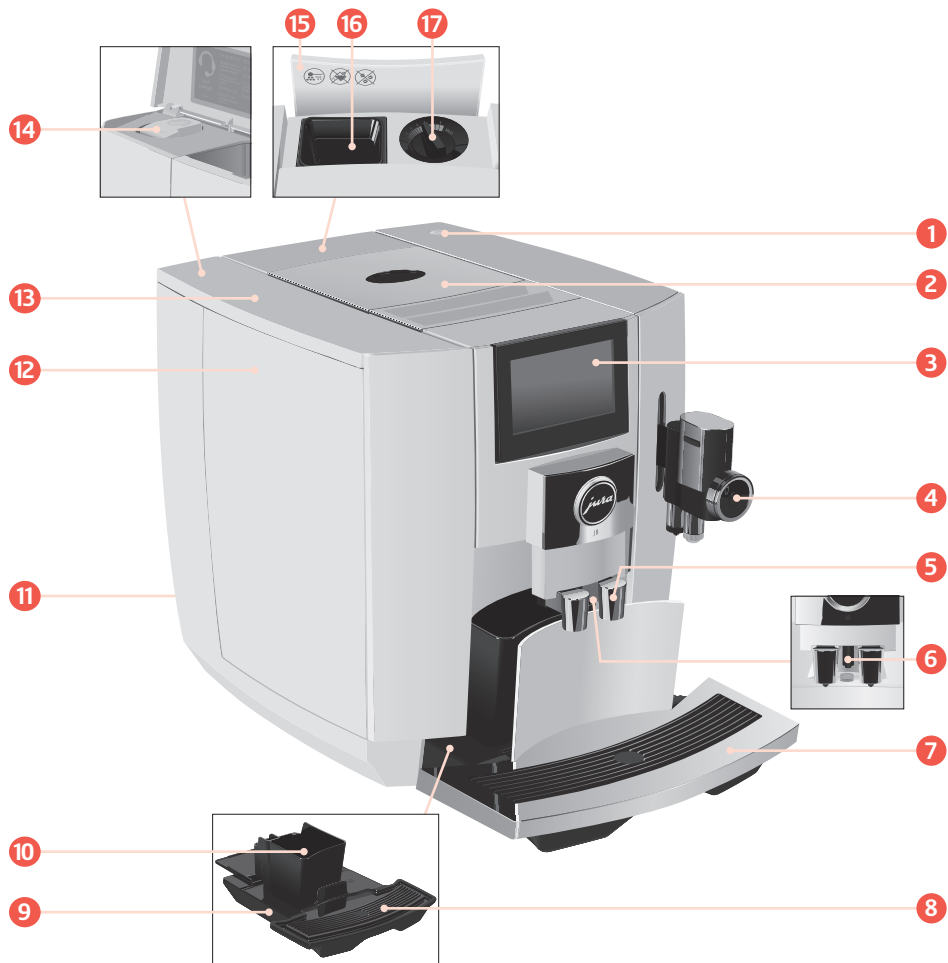

- 1 On/Off button
- 2 Bean container with aroma preservation cover
- 3 Touch display
- 4 Milk system with professional fine foam frother (height-adjustable)
- 5 Height-adjustable coffee spout
- 6 Hot-water spout
- 7 Cup grille with aperture
- 8 Insert for drip tray
- 9 Drip tray
- 10 Coffee grounds container
- 11 Mains cable (permanently connected or plug-in)
- 12 Water tank
- 13 Water tank cover
- 14 Service socket with JURA WiFi Connect (under cover)
- 15 Filler funnel cover
- 16 Filler funnel for ground coffee (removable)
- 17 Grinder adjustment switch
- 18 Container for milk system cleaning
- 19 Measuring spoon for ground coffee
- 20 Syrup attachment





2 For your safety

Comply with the instructions for use

Before using the machine, read these instructions for use thoroughly and completely and comply with the instructions they contain. Keep these instructions for use close to the machine and pass them on to the next user.

Failure to observe the instructions for use may result in serious injuries or damage to property. Safety information is therefore indicated as follows:

 WARNING	Indicates circumstances that may result in serious injuries or death.
 CAUTION	Indicates circumstances that may result in minor injuries.
CAUTION	Indicates circumstances that may result in damage to property.

Proper use

The machine is intended for private domestic use. It should only be used for coffee preparation and to heat milk and water. Use for any other purpose will be deemed improper.

User limitations

People, including children, who

- do not have the physical, sensory or mental capabilities to use the machine safely or
- are inexperienced or lack knowledge

must be supervised by a responsible person when using it, or must be instructed in how to use it correctly.

When using the CLARIS Smart filter cartridge or a JURA WiFi Connect, wireless connections are established. Specific details on the frequency band used and the maximum transmission power can be found in the '11 Technical data' section.

Use by children

Children must be able to recognise and understand the potential dangers arising from incorrect use:

- Keep **children under the age of 8** away from the machine, or supervise them constantly.
- **Children aged 8 and over** may only operate the machine without supervision if they have been instructed in how to use it safely.
- Children may not clean or service the machine unless supervised by a responsible person.
- Do not allow children to play with the machine.

What to do in the event of damage

Never use a damaged machine or mains cable. This could result in fatal electric shock.

- In the event of signs of damage, disconnect the machine from the mains. To do this, first switch the J8 off with the On/Off button . Only then should you remove the mains plug from the power socket.
- Replace a damaged **plug-in mains cable** with an original JURA mains cable. Unsuitable mains cables may result in consequential damage.
- Only permit authorised JURA service centres to carry out **repairs to the machine** and the **permanently connected mains cable**. Unsuitable repairs may result in consequential damage.

Preventing damage

To avoid damage to the machine and the mains cable:

- Do not use the J8 and the mains cable near hot surfaces.
- Do not allow the mains cable to rub against sharp edges and ensure that it does not become trapped.
- Never allow the mains cable to loosely hang down. The mains cable could pose a tripping hazard or become damaged.
- Protect the J8 from weather and direct sunlight.
- Only connect the J8 to a mains voltage corresponding to that stated on the rating plate. The rating plate is located on the underside.
- Connect the J8 directly to a domestic power socket. Using multi-socket adapters or extension cords may cause overheating.
- Do not use alkaline or alcohol-based cleaning agents; only use mild cleaning agents and a soft cloth.
- Do not use any coffee beans treated with additives or caramelised coffee beans.
- Only fill the water tank with fresh, cold, non-carbonated water.
- Switch the machine off with the On/Off button  if you are going to be absent for a longer period of time and remove the mains plug from the power socket.
- Only use original JURA maintenance products. Use of products that are not explicitly recommended by JURA could damage your J8.

Danger of electric shock

Water conducts electricity. Do not bring water and electricity into contact with one another:

- Never touch the mains plug with wet hands.
- Do not immerse the J8 and/or mains cable in water.
- Do not put the J8 or any individual parts in the dishwasher.
- Before cleaning, switch the J8 off with the On/Off button . Always wipe the J8 with a damp cloth rather than a wet one, and protect it from prolonged exposure to water splash. The J8 must not be cleaned with a jet of water.
- The J8 is not suitable for installation on a surface where a jet of water can be used.

Danger of burns, scalding and injury

- Do not touch the spouts during operation. Use the handles provided.
- Optionally, your J8 can be remotely operated using mobile devices. When preparing a product or initiating a maintenance programme, make sure that other people are not put at risk – for example, through contact with the spouts.
- Be careful to ensure that the fine foam frother is correctly installed and clean, otherwise the fine foam frother (or parts of it) may come loose.

3 Preparing and using for the first time

Setting up the machine

- ▶ Choose a spot for your J8 which protects the machine against overheating. Ensure that the ventilation slots are not covered.

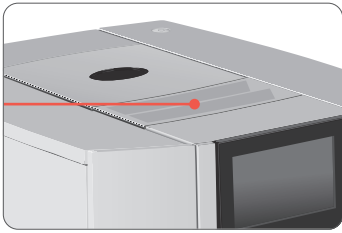

- ▶ Place the J8 on a horizontal surface that is not sensitive to water.

Filling the bean container

The bean container has an aroma preservation cover. This will ensure that your coffee beans retain their aroma for longer.

CAUTION

Coffee beans which have been treated with additives (e.g. sugar), ground coffee or freeze-dried coffee will damage the grinder.

- ▶ Only use roasted, untreated coffee beans to fill the bean container.
- ▶ Remove the aroma preservation cover.
- ▶ Remove any dirt or foreign objects from inside the bean container.
- ▶ Fill the bean container with coffee beans and close the aroma preservation cover.

Determining the water hardness

When you use the machine for the first time, you must set the water hardness. If you know the hardness of your water, go straight to the next section. If you do not know the water hardness, you can find this out first:

- ▶ Hold the Aquadur® test strip supplied under running water for one second. Shake off the water.
- ▶ Wait for about 1 minute.
- ▶ You will then be able to read the degree of water hardness from the discolouration of the Aquadur® test strip and the description on the packaging.

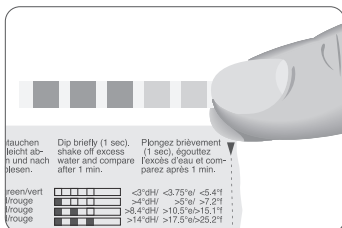

First-time use

⚠ WARNING

If the machine is operated with a defective mains cable, there is a danger of potentially fatal electric shock.

- ▶ Never use a machine which is damaged or has a defective mains cable.

CAUTION

Milk, sparkling mineral water or other liquids can damage the water tank or the machine.

- ▶ Only fill the water tank with fresh, cold water.

Precondition: The bean container has been filled.

- ▶ For machines with a **plug-in** mains cable: Connect the mains cable to the machine.
- ▶ Insert the mains plug into a power socket.
- ▶ Press the On/Off button  to switch the J8 on.

'Sprachauswahl' / 'Deutsch'

- ▶ To display more languages, touch < or > until the desired language comes into focus (e.g. 'English').

- ▶ Touch 'Save'.
'Saved' appears briefly on the display.
'Water hardness'

i Please refer to the section above for a description of how to determine the water hardness.

- ▶ Touch < or > to change the water hardness setting.
- ▶ Touch 'Save'.
'Saved' appears briefly on the display.
'Insert filter'
- ▶ Place a receptacle under the coffee spout.



- ▶ Remove the water tank and rinse it with cold water.
- ▶ Fit the filter cartridge extension supplied on top of the CLARIS Smart filter cartridge.



- ▶ Insert the filter cartridge with its extension into the water tank.
- ▶ Turn the filter cartridge clockwise until it audibly clicks into place.

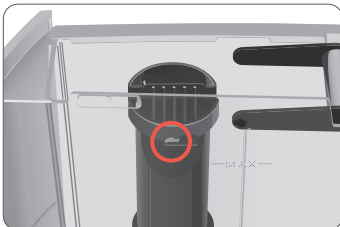

- ▶ Fill the water tank with fresh, cold water and reinsert the tank.

i The machine automatically detects that you have just inserted the filter cartridge.

- 'Saved'
- 'Filter is being rinsed', water flows directly into the drip tray.
- 'System is filling'
- 'Empty drip tray'

- ▶ Empty the drip tray and put it back into the machine.



'Accessory'

i You have the option of connecting the J8 to the JURA Cool Control milk cooler (wireless connection). To do this, touch 'Connect' and follow the instructions on the display.

- ▶ Touch 'Next'.
'Wi-Fi connection'

3 Preparing and using for the first time

- If necessary, scan the QR code with your mobile device to download the JURA app (J.O.E.™).



- i** If you would like to connect the J8 to your home network, touch **'Connect'** and follow the instructions on the display. You can also establish the connection later on (in the machine settings under **'Wi-Fi connection'**).

- Place a receptacle under the coffee spout.
- Touch **'Next'**.







'Machine is rinsing'

The start screen is displayed. Your J8 is ready for use.

Managing your J8 – the JURA Cockpit

The **JURA Cockpit** allows you to manage your J8. Touch  on the start screen to open the JURA Cockpit.



Symbol	Meaning
	'Maintenance' section (blue)
	'Machine setting' section (green)
	The 'Coffee Eye' function (for cup detection) is enabled.
 (white)	Your J8 is connected with the network and/or Cool Control via JURA WiFi Connect.
 (red)	No connection to the WiFi network
	Filter mode

Coffee Eye

The J8 has an automatic cup detection feature. The 'Coffee Eye' detects when you place a cup under the **coffee spout**. The adapted start screen will now show the black coffee and hot water specialities that you can prepare.

Connecting milk

Your J8 creates fine, creamy, feather-light milk foam with a perfect consistency. The most important requirement for frothing milk is a milk temperature of 4–8 °C. We would therefore recommend using a milk cooler or a milk container.

- Remove the protective cover from the fine foam frother.
- Connect the milk pipe to the fine foam frother.

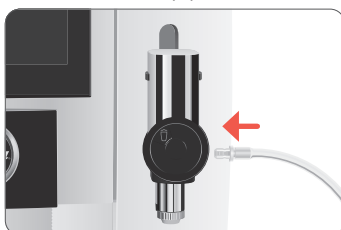



- Connect the other end of the milk pipe to a milk container or a milk cooler.

- i** Your J8 is equipped with the **HP3** milk system.

Establishing a WiFi connection



Your J8 can be connected with your JURA app (J.O.E.*).

Precondition: J.O.E.* is installed on your mobile device. The JURA WiFi Connect is inserted into the service socket of your J8.

- ▶ Touch .
- ▶ Touch the 'Machine setting'  symbol.
- ▶ Touch 'Wi-Fi connection'.
- ▶ Touch 'Connect'.
- ▶ Add a new network in your JURA app (J.O.E.*) and follow the instructions.

4 Preparation





Basic information about preparing drinks:

Aim	What to do
Display more products	Touch    to display additional pages of the start screen; touch the product selector symbol at bottom right to access the product selector view
Change the coffee strength of a single product	While the grinder is operating, swipe across the display with your finger
Change the amount for a single product	During preparation, swipe across the display with your finger
Permanently change the coffee strength, quantity and temperature for any given product	Tap and hold a product for around 2 seconds and configure the settings under 'Product settings'
Changing the consistency of grind	Turn the grinder adjustment switch to the desired position
Stop preparation	Touch 'Cancel'
Place a product on the start screen as a favourite	Tap and hold a product for around 2 seconds and place another product under 'Replace product'

- i** If the screensaver is active, touch the display to return to the start screen.
- i** Coffee tastes best served hot. A cold porcelain cup cools the beverage – and impairs the taste. We therefore recommend prewarming the cups. You can purchase a JURA cup warmer from your specialised dealer.

Preparation with preselection (Speciality Selection)

Touch  to call up the Speciality Selection and activate the desired preselection for your next product:

Speciality Selection	Meaning
 – 'Sweet milk foam' (all speciality coffees with milk)	Use the syrup attachment provided to prepare the product with sweet milk foam.
 – 'Extra Shot' (sweet latte, cappuccino, café au lait, latte macchiato, flat white)	The product is prepared with two brewing operations, with half the amount of water – for a speciality coffee with a particularly intense taste.
 – Double product (espresso, coffee)	The product is prepared twice in succession (2 strokes).
 – Ground coffee (all speciality coffees except for espresso doppio)	The product is prepared with ground coffee.

- i** The Speciality Selection closes after 10 seconds.
- i** If you press your preselection **briefly**, the next product will be prepared according to your preselection.
- i** If you press and **hold** your preselection (for 2 seconds), the preselection will be active until you switch off your J8.

Espresso and coffee

Example: Coffee

- ▶ Place a cup under the coffee spout.



4 Preparation

- ▶ Touch **'Coffee'**.
The preset amount of water for coffee flows into the cup.

Sweet latte (prepared with syrup attachment)

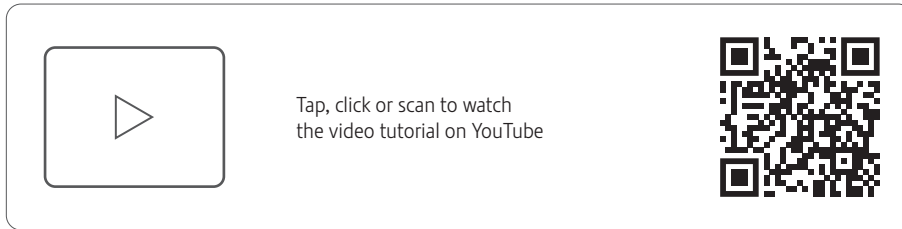

The sweet latte is a speciality coffee with sweet milk foam. To make this speciality, use the syrup attachment provided.

- i** All speciality coffees with milk can also be prepared with **sweet milk foam**. To do this, use the syrup attachment provided and before starting preparation, select the Speciality Selection **'S'**.

Precondition: Milk is connected to the fine foam frother.

- ▶ Remove the cover from the syrup attachment.



- ▶ Fill the syrup attachment with syrup. Fill it to the first, second or third mark depending on the desired sweetness.
- ▶ Close the syrup attachment.
- ▶ Touch **'Sweet Latte'**.
'Please connect the syrup attachment, ensuring it is filled with syrup'
- ▶ Remove the lower part of the fine foam frother.



- ▶ Connect the syrup attachment to the fine foam frother.



- ▶ Turn the setting wheel of the fine foam frother to the **'Milk Foam'** position.
- ▶ Place a cup under the fine foam frother.
- ▶ Touch **'Next'**.
The preset amounts of coffee and milk foam flow into the cup.
'Please remove the syrup attachment'
- ▶ Remove the syrup attachment and rinse it thoroughly under running water.
- ▶ Touch **'Next'**.

- i** **8 minutes** after preparation, the milk system is **automatically** rinsed. Therefore always place a receptacle under the fine foam frother after preparing milk.

To ensure that the fine foam frother always works properly, you must clean it **daily** when you have been preparing milk (see chapter 7 'Maintenance – Cleaning the milk system').

Latte macchiato, cappuccino and other speciality coffees with milk

Your J8 prepares the following speciality coffees with milk at the touch of a button:

- Latte macchiato
- Flat white
- Cappuccino
- Cortado
- Macchiato
- Café au lait

Example: Latte macchiato

Precondition: Milk is connected to the fine foam frother.

- Place a glass under the fine foam frother.



- Turn the setting wheel of the fine foam frother to the 'Milk Foam' position.
- Touch 'Latte macchiato' (page ○●○).

The preset amount of milk foam flows into the glass.

i There is a short interval while the hot milk separates from the milk foam. This allows the typical layers of a latte macchiato to form.

The preset amount of water for espresso flows into the glass.

i **8 minutes** after preparation, the milk system is **automatically** rinsed. Therefore always place a receptacle under the fine foam frother after preparing milk.

To ensure that the fine foam frother always works properly, you must clean it **daily** when you have been preparing milk (see chapter 7 'Maintenance – Cleaning the milk system').

Milk and milk foam

Your J8 prepares hot milk and milk foam. To do this, turn the setting wheel of the fine foam frother to the 'Milk Foam' or 'Milk' position.

i **8 minutes** after preparation, the milk system is **automatically** rinsed. Therefore always place a receptacle under the fine foam frother after preparing milk.

Americano and lungo

For the americano and lungo, the J8 blends the coffee with hot water using a special preparation method. This results in a full-bodied speciality coffee which is particularly easy to digest. You can change the amount of this additional water (see chapter 4 'Preparation – Adjusting the product settings').

Espresso doppio

'Doppio' is Italian for 'double'. When you select Espresso doppio, two espressi are prepared one after the other. The result is an extra full-bodied and aromatic speciality coffee.

Ground coffee

You can choose to use a second coffee variety, for example decaffeinated coffee, with the filter funnel for ground coffee.

- Never add more than two level measuring spoons of ground coffee.
- Use ground coffee which is not ground too finely. Very fine coffee can block up the system so that the coffee only comes out in drips.
- If you did not fill the machine with a sufficient amount of ground coffee, 'Not enough ground coffee' is displayed and the J8 stops the operation.
- The desired speciality coffee must be prepared within approximately one minute after filling with the ground coffee. Otherwise the J8 stops the operation and is once more ready for use.

4 Preparation

Example: Proceed as follows to prepare an espresso using ground coffee.

- Place an espresso cup under the coffee spout.
- Touch '■■■■' to call up the Speciality Selection.
- Touch ☕.
- Touch 'Espresso'.
- 'Please add ground coffee'
- Open the cover of the filler funnel for ground coffee.



- Add the desired amount of ground coffee to the filler funnel (max. 2 level measuring spoons).

i The amount of ground coffee determines the intensity and aroma of the beverage, so you can adjust it to your personal preferences.

- Close the cover of the filler funnel.
- Touch 'Next'.
- The preset amount of water for espresso flows into the cup.

Hot water

The J8 allows you to prepare different variants of hot water:

- 'Hot water'
- 'Hot water for green tea' (in the product selector view)

⚠ CAUTION

There is a danger of scalding from hot water splashes.

- Avoid direct contact with the skin.
-

Example: Hot water

- Place a cup under the hot-water spout.



- Touch 'Hot water'.
- The preset amount of water flows into the cup.

Adjusting the product settings



Tap, click or scan to watch
the video tutorial on YouTube



Touch a product for **approximately 2 seconds** to access the settings:

- 'Product settings': Specify individual settings such as coffee strength, amount of water, etc.
- 'Product name': Change the name of the product.
- 'Permanent preselection': Specify a permanent preselection (Speciality Selection).
- 'Replace product': Replace the products on the start screen with your favourites.

i If there is a cup under the coffee spout ('Coffee Eye' enabled), not all settings will be possible.

Example: Proceed as follows to change the coffee strength for one coffee.

- ▶ Touch 'Coffee' for **approximately 2 seconds**.
- ▶ Touch 'Product settings'.

i Depending on the selected product, there will be different settings available which are represented by symbols on your display.

- ▶ Touch the ☕ symbol.
The ☕ symbol appears in white.
- ▶ Swipe across the coffee beans with your finger to change the coffee strength setting.
- ▶ Touch 'Save'.
- ▶ Touch 'Back' to return to the start screen.

5 Daily operation

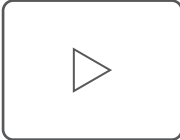

Tap, click or scan to watch
the video tutorial on YouTube



Switching the machine on and off

- ▶ Place one receptacle under the coffee spout and another under the fine foam frother.



- ▶ Press the On/Off button .

'Machine is rinsing'

Your J8 is switched on or off.

i When the machine is switched off, the system is only rinsed if a speciality coffee has been prepared.

i If milk has been prepared before switching off, you will be prompted to carry out milk system cleaning ('Clean the milk system'). After 30 seconds the switch-off process continues automatically.

Filling the water tank

Daily maintenance of the machine and hygiene when handling milk, coffee and water are key to a perfect coffee result in the cup every time. You should therefore change the water **daily**.

CAUTION



Milk, sparkling mineral water or other liquids can damage the water tank or the machine.

- ▶ Only fill the water tank with fresh, cold water.
- ▶ Remove the water tank and rinse it with cold water.
- ▶ Fill the water tank with fresh, cold water and reinsert the tank.

Maintenance actions

Optimal coffee quality depends on many factors. One important prerequisite is regular maintenance of your J8. Carry out the following steps:

Maintenance action	Daily	If necessary	Note
Empty the drip tray and coffee grounds container and rinse with warm water (The insert for the drip tray, including the drip tray itself, and the coffee grounds container are dishwasher-safe)	▪		Always empty the coffee grounds container when the machine is switched on. This is the only way of resetting the coffee grounds counter.
Clean the milk system (if heavily soiled, also dismantle it)		▪	See chapter 7 'Maintenance – Dismantling and rinsing the professional fine foam frother'
Rinse the milk pipe	▪		
Rinse the water tank	▪		
Wipe the surface of the machine with a clean, soft, damp cloth (e.g. microfibre cloth)	▪		
Changing milk pipe with connector HP3		approx. every 3 months	
Change the interchangeable milk spout CX3		approx. every 3 months	
Clean the inside of the water tank with a brush		▪	
Clean the top and bottom of the cup grille		▪	
Thoroughly clean the drip tray and coffee grounds container		▪	In the 'Maintenance' area  of the Cockpit, the message 'Maintenance information' appears.

 You will find more information about maintenance of your J8 in the 'Maintenance'  section in the programme item 'Maintenance information'.

6 Machine settings

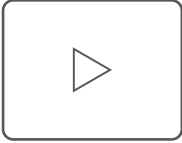

Tap, click or scan to watch
the video tutorial on YouTube







Touch  to open the Cockpit. In the 'Machine setting'  section, you can make the following settings:

Programme item	Explanation
Page '1/3'	
'Coffee Eye'	Enable/disable automatic cup detection with the 'Coffee Eye'
'Product name'	Display product images with/without product names on the start screen
'Number of start screens'	Define number of start screens (1–4)
'Number of products'	Set the number of products on the start screen: 2 products / 5 products
'Wi-Fi connection'	J8 connect wirelessly with the JURA app (J.O.E.™) or disconnect again (see chapter 3 'Preparing and using for the first time – Establishing a WiFi connection')
'Switch off after'	Set the automatic switch-off time to save energy (switch-off after 15 minutes, 30 minutes or 1 – 9 hours after the last action on the machine)
'Choose language'	Set language
'Factory setting'	Reset your J8 to factory settings (the machine then switches off)
Page '2/3'	
'Water hardness'	Set the hardness of the water used (1 °dH to 30 °dH) to prevent limescale building up in your machine
'Units'	Set the unit for the amount of water (ml or oz)
'Accessory'	Establish a wireless connection between your J8 and the Cool Control milk cooler or disconnect it again
'Display'	Change display brightness (in 10% increments)
'Product counter'	View product counter

Programme item	Explanation
'Maintenance counter'	View the maintenance counter
'Operating instructions'	Show instructions for using the syrup attachment and fine foam frother and switching between milk and milk foam
'Aroma control'	Show recommended settings for consistency of grind (enabled/disabled)
Page '3/3'	
'Rinse the milk system'	Set whether milk system rinsing takes place automatically or needs to be started manually
'Empty system'	Empty the system to protect the J8 from frost during transport
'Information'	View software version

7 Maintenance

Basic information about maintenance:

- Touch  to open the Cockpit. This area consists of a 'Maintenance status'  section and a 'Machine setting'  section. You can manage the maintenance of your J8 in the  section.
- The Cockpit shows maintenance programmes that need to be carried out in the form of messages with red backgrounds. Touch a message to go straight to the corresponding maintenance programme. Maintenance programmes that are due imminently are indicated on your J8 by means of a bar display within the message.
- Carry out each maintenance programme when you are prompted to do so.



Rinsing the machine

You can start coffee system rinsing manually at any time.

Precondition: The start screen is displayed.

- Place one receptacle under the coffee spout and another under the fine foam frother.



- Touch .
- Touch the 'Maintenance' symbol .
- Touch 'Rinse the coffee system' to start the rinse operation.
'Machine is rinsing'
The rinse stops automatically. The start screen is displayed.

Rinsing the milk system



After each milk preparation, the J8 prompts you to perform a milk system rinse.

In the machine settings you can define whether milk system rinsing takes place automatically or needs to be started manually (see chapter 6 'Machine settings').

Precondition: The start screen is displayed.

- Place a receptacle under the fine foam frother.



- Touch .
- Touch the 'Maintenance' symbol .
- Press the 'Rinse the milk system' button to start the rinse operation.
'Milk system is being rinsed'
The rinse stops automatically. The start screen is displayed.

Cleaning the milk system

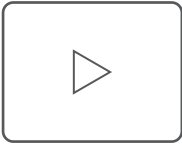

Tap, click or scan to watch
the video tutorial on YouTube



To ensure that the milk system always works properly, you must clean it **daily** when you have been preparing milk.

CAUTION

If the wrong cleaning agent is used, the machine could be damaged and/or traces could be left behind in the water.

- ▶ Use only original JURA maintenance products.

i JURA milk system cleaner is available from specialised dealers.

i Use the container supplied for milk system cleaning.

Precondition: The start screen is displayed. 'Clean the milk system' is displayed in the Cockpit.

- ▶ Touch 'Clean the milk system'.
- ▶ Touch 'Next'.
- ▶ 'Cleaning agent for milk system' / 'Connect the milk tube'
- ▶ Remove the milk pipe from the milk container or milk cooler.
- ▶ Pour one dosing unit of milk system cleaner into the container for milk system cleaning.



- ▶ Place the container under the coffee spout and the fine foam frother.
- ▶ Connect the milk pipe to the container.



i To connect the milk pipe to the container correctly, the pipe must be fitted with a connector.

- ▶ Touch 'Start'.
- The fine foam frother and the milk pipe are cleaned.
The operation stops automatically.

Dismantling and rinsing the professional fine foam frother

If insufficient foam is produced when the milk is frothed or milk sprays out of the professional fine foam frother, the frother may be dirty. If this happens, dismantle and rinse the professional fine foam frother.

- ▶ Remove the milk pipe and rinse it thoroughly under running water.
- ▶ Remove the professional fine foam frother.

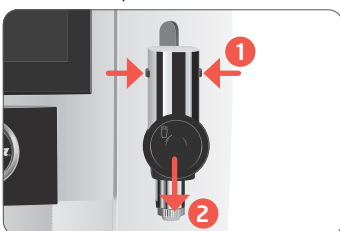

- ▶ Dismantle the fine foam frother into its individual parts.

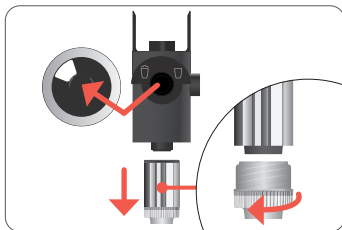

- ▶ Rinse all the parts under running water. If there are severely dried-on milk residues, firstly immerse the individual parts in a solution of 250 ml water and one dosing unit of JURA milk system cleaner. Then rinse the individual parts thoroughly.
- ▶ Re-assemble the professional fine foam frother.

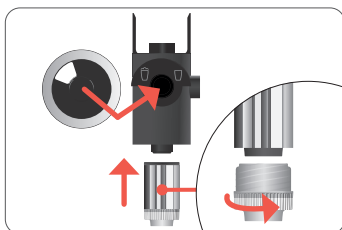

- i** Ensure that all individual parts are correctly and firmly connected to ensure optimum operation of the professional fine foam frother.

- ▶ Re-fit the professional fine foam frother on the milk system.

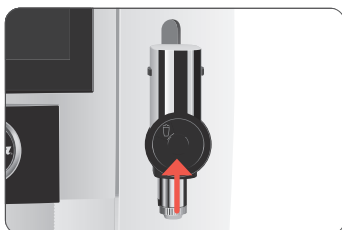

Inserting/changing the filter

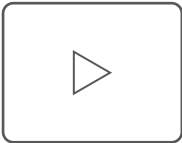

Tap, click or scan to watch
the video tutorial on YouTube



Once the filter cartridge stops working (depending on the water hardness setting), the J8 will prompt you to change the filter.

- i** Your J8 no longer has to be descaled if you are using the CLARIS Smart filter cartridge.
- i** CLARIS Smart filter cartridges are available from specialised dealers.

Precondition: The start screen is displayed. (Alternatively, 'Change the filter' is displayed in the Cockpit if the filter's capacity has been exhausted.)

- ▶ Remove and empty the water tank.
- ▶ Turn the filter cartridge anticlockwise and remove it along with the extension from the water tank.
- ▶ Remove the old CLARIS filter cartridge Smart.
- ▶ Fit the filter cartridge extension on top of a **new** CLARIS Smart filter cartridge.



7 Maintenance

- ▶ Insert the filter cartridge with its extension into the water tank.
- ▶ Turn the filter cartridge clockwise until it audibly clicks into place.

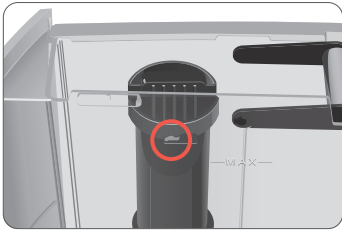

- ▶ Fill the water tank with fresh, cold water and reinsert the tank.
The machine automatically detects that you have just inserted/changed the filter cartridge.
'Filter is being rinsed', water flows directly into the drip tray.
'Empty drip tray'
- ▶ Empty the drip tray and coffee grounds container and put them back into the machine.
The start screen is displayed.

Cleaning the machine

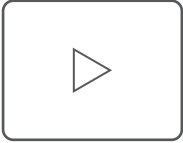

Tap, click or scan to watch
the video tutorial on YouTube



After 180 preparations or 80 switch-on rinses, the J8 will prompt you to clean it.

CAUTION

If the wrong cleaning agent is used, the machine could be damaged and/or traces could be left behind in the water.

- ▶ Use only original JURA maintenance products.

- i** The cleaning programme lasts approximately 20 minutes.
- i** Do not interrupt the cleaning programme. The quality of cleaning will be impaired if you do so.
- i** JURA cleaning tablets are available from specialised dealers.

Precondition: **'Clean'** is displayed in the Cockpit.

- ▶ Fill the water tank.
- ▶ Touch **'Clean'**.
- ▶ Touch **'Start'**.
'Empty drip tray' / 'Empty coffee grounds container'
- ▶ Empty the drip tray and coffee grounds container and put them back into the machine.
- ▶ Place one receptacle under the coffee spout and another under the fine foam frother.



- ▶ Touch **'Next'**.
'Machine is being cleaned'
The operation is interrupted, **'Add cleaning tablet'**.
- ▶ Open the cover of the filler funnel for ground coffee.

- ▶ Insert a JURA cleaning tablet into the filler funnel.



- ▶ Close the cover of the filler funnel.
- ▶ Touch 'Next'.
 - 'Machine is being cleaned'
 - 'Empty drip tray' / 'Empty coffee grounds container'
- ▶ Empty the drip tray and coffee grounds container and put them back into the machine.

Descaling the machine

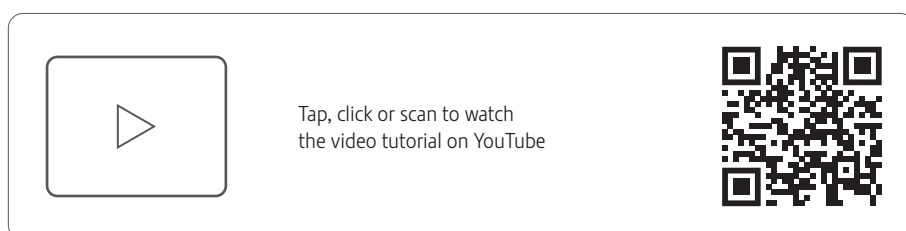

The J8 builds up deposits of limescale over time and automatically prompts you to descale it when necessary (unless you are using a CLARIS Smart filter cartridge).

⚠ CAUTION

If the descaling agent comes into contact with the skin or eyes, this can cause irritation.

- ▶ Avoid contact with the skin or eyes.
- ▶ Rinse off the descaling agent with clean water. Should you get any descaling agent in your eye, see a doctor.

CAUTION

If the wrong descaling agent is used, the machine could be damaged and/or traces could be left behind in the water.

- ▶ Use only original JURA maintenance products.

CAUTION

If the descaling operation is interrupted, there may be damage to the machine.

- ▶ Allow the descaling programme to run to the end.

CAUTION

If the descaling agent comes into contact with sensitive surfaces (e.g. marble), damage cannot be ruled out.

- ▶ Clean up any splashes immediately.

- i** The descaling programme lasts approximately 45 minutes.
- i** JURA descaling tablets are available from specialised dealers.

Precondition: 'Descal' is displayed in the Cockpit.

- ▶ Touch 'Descal'.
- ▶ Touch 'Start'.
 - 'Empty coffee grounds container' / 'Empty drip tray'
- ▶ Empty the drip tray and coffee grounds container and put them back into the machine.
 - 'Pour descaling agent into water tank'
- ▶ Remove and empty the water tank.

7 Maintenance

- ▶ Completely dissolve 3 JURA descaling tablets in a receptacle holding 500 ml of water. This may take several minutes.

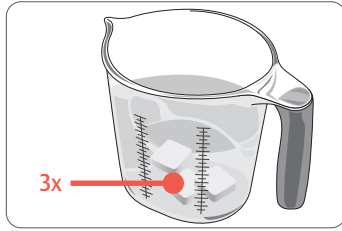

- ▶ Pour the solution into the **empty** water tank and insert it into the machine.
- ▶ Place one receptacle under the coffee spout and another under the fine foam frother.



- ▶ Touch 'Next'.
'Machine is being descaled', water flows repeatedly out of the hot-water spout and fine foam frother straight into the drip tray.
'Empty coffee grounds container' / 'Empty drip tray'
- ▶ Empty the drip tray and coffee grounds container and put them back into the machine.
'Rinse the water tank' / 'Fill water tank'
- ▶ Empty the receptacles and place them back under the coffee spout and the fine foam frother.
- ▶ Remove the water tank and rinse it thoroughly.
- ▶ Fill the water tank with fresh, cold water and reinsert the tank.
- ▶ Touch 'Next'.
Water flows repeatedly out of the hot-water spout and fine foam frother straight into the drip tray.
'Empty coffee grounds container' / 'Empty drip tray'
- ▶ Empty the drip tray and coffee grounds container and put them back into the machine.

i If the descaling operation stops unexpectedly, rinse the water tank thoroughly.

Descaling the water tank

Limescale deposits may form in the water tank. To ensure correct function of the machine, descale the water tank from time to time.

- ▶ Remove the water tank.
- ▶ If you use a CLARIS Smart filter cartridge, remove this.
- ▶ Completely fill the water tank and dissolve 3 JURA descaling tablets in it.
- ▶ Leave the water tank with the descaling solution for several hours (e.g. overnight).
- ▶ Empty the water tank and rinse it thoroughly.
- ▶ If you use a CLARIS Smart filter cartridge, insert this again.
- ▶ Fill the water tank with fresh, cold water and reinsert the tank.

Cleaning the bean container

Coffee beans may be covered with a slight oil film which remains on the walls of the bean container. These traces may negatively affect the coffee result. For this reason clean the bean container from time to time.

Precondition: 'Fill bean container' is displayed.

- ▶ Switch the machine off with the On/Off button .
- ▶ Remove the aroma preservation cover.
- ▶ Clean the bean container with a soft, dry cloth.
- ▶ Fill the bean container with coffee beans and close the aroma preservation cover.

8 Display messages

Messages on the start screen

Message	Cause/Result	Action
'Fill water tank'	The water tank is empty. You cannot prepare any products.	▸ Fill the water tank (see chapter 5 'Daily operation – Filling the water tank').
'Empty coffee grounds container' / 'Empty drip tray'	The coffee grounds container is full. / The drip tray is full. You cannot prepare any products.	▸ Empty the coffee grounds container and the drip tray (see chapter 5 'Daily operation – Maintenance actions').
'Drip tray not fitted'	The drip tray is not inserted correctly or is not inserted at all. You cannot prepare any products.	▸ Fit the drip tray.
'Fill bean container'	The bean container is empty. You cannot prepare any speciality coffees, but you can prepare hot water and milk.	▸ Fill the bean container (see chapter 3 'Preparing and using for the first time – Filling the bean container').
'Not enough ground coffee'	There is insufficient ground coffee in the machine; the J8 stops the operation.	▸ The next time you prepare a beverage, add more ground coffee (see chapter 4 'Preparation – Ground coffee').

Messages in the Cockpit

Message	Cause/Result	Action
The filter symbol  lights up red. 'Change the filter'	The filter cartridge no longer works.	▸ Replace the CLARIS Smart filter cartridge (see chapter 7 'Maintenance – Inserting/changing the filter').
'Clean'	The J8 is prompting you to clean it.	▸ Perform cleaning (see chapter 7 'Maintenance – Cleaning the machine').
'Descale'	The J8 is prompting you to descale it.	▸ Perform descaling (see chapter 7 'Maintenance – Descaling the machine').
'Clean the milk system'	The J8 prompts you to clean the milk system.	▸ Perform milk system cleaning (see chapter 7 'Maintenance – Cleaning the milk system').

9 Troubleshooting

Problem	Cause/Result	Action
Insufficient foam is produced when the milk is frothed or milk sprays out of the fine foam frother.	The fine foam frother is dirty.	▸ Clean the fine foam frother (see chapter 7 'Maintenance – Cleaning the milk system'). ▸ Dismantle and rinse the fine foam frother (see chapter 7 'Maintenance – Dismantling and rinsing the professional fine foam frother').
The 'Coffee Eye' reports a cup under the coffee spout even though no cup has been placed there.	The cup detection sensor behind the coffee spout is dirty.	▸ Clean the sensor with a damp cloth.
Coffee only comes out in drips when it is being prepared.	The coffee is ground too finely and obstructs the system. The water hardness may not have been correctly set.	▸ Put the grinder on a coarser setting or use coarser ground coffee. ▸ Perform descaling (see chapter 7 'Maintenance – Descaling the machine').
There is dry ground coffee behind the coffee grounds container.	The beans used are resulting in an above-average volume of ground coffee.	▸ Reduce the coffee strength or choose a finer grinder setting (see chapter 4 'Preparation – Adjusting the product settings').
'Fill water tank' is not displayed although the water tank is empty.	There is a lot of limescale in the water tank.	▸ Descale the water tank (see chapter 7 'Maintenance – Descaling the water tank').
Grinder is making a very loud noise.	There are foreign objects in the grinder.	▸ Contact customer support in your country (see chapter 13 'JURA contact details / Legal information').

Problem	Cause/Result	Action
'Error 2' or 'Error 5' is displayed.	If the machine has been exposed to the cold for a long period of time, heating may be disabled for safety reasons.	▶ Warm the machine at room temperature.
Other 'Error' messages are displayed.	–	▶ Switch the J8 off with the On/Off button  . Contact customer support in your country (see chapter 13 'JURA contact details / Legal information').

i If you were unable to solve the problem, contact customer support in your country (see chapter 13 'JURA contact details / Legal information').

10 Transport and environmentally friendly disposal

Transport / Emptying the system



Keep the packaging for your J8. It should be used to protect the machine during transport.

In order to protect the J8 from frost during transport, the system must be emptied.

Precondition: The start screen is displayed.

- ▶ Remove the milk pipe from the fine foam frother.
- ▶ Place a receptacle under the fine foam frother.



- ▶ Touch .
 - ▶ Touch the 'Machine setting'  symbol.
 - ▶ Switch to the '3/3' page.
 - ▶ Touch 'Empty system'.
 - ▶ Remove and empty the water tank.
 - ▶ Touch 'Next'.
- Steam will continue to be discharged from the fine foam frother until the system is empty.
Your J8 is switched off.

Disposal

Please dispose of old machines in an environmentally neutral way.



Old machines contain valuable, recyclable materials which should be recycled. Please therefore dispose of old machines via suitable collection systems.

11 Technical data

Voltage	220–240 V ~, 50 Hz
Power	1450 W
Conformity mark	CE
Pump pressure	static, max. 15 bar
Holding capacity of water tank (without filter)	1.9 l
Holding capacity of bean container	280 g
Holding capacity of coffee grounds container	max. 16 portions
Cable length	approx. 1.1 m
Weight	10.3 kg
Dimensions (W × H × D)	31.8 × 34.8 × 44.6 cm
Milk system with connector	HP3
CLARIS filter cartridge Smart (RFID technology)	Frequency band 13.56 MHz Max. transmission power < 1 mW
JURA WiFi Connect	Frequency band 2.4 GHz Max. transmission power < 100 mW
JURA type	765

Information for testers (repeat test in accordance with DIN VDE 0701-0702): The central grounding point (CGP) is located on the back of the machine, right next to the mains cable's connection point.

12 Index**A**

- Addresses 26
- Adjusting the product settings 12
- Americano 11
- Aroma preservation cover
 - Bean container with aroma preservation cover 3

B

- Bean container
 - Bean container with aroma preservation cover 3
 - Cleaning 20
 - Filling 6
- Bus bar
 - Technical data 23
- Button
 - On/Off button 3

C

- Caffè latte 11
- Cappuccino 11
- Central grounding point 23
- Children 4
- CLARIS Smart filter cartridge
 - Changing 17
 - Inserting 17
- Cleaning
 - Bean container 20
 - Machine 18
- Cockpit 8, 14, 15
- Coffee 9
- Coffee Eye 8
- Coffee grounds container 3
- Coffee spout
 - Height-adjustable coffee spout 3
- Connecting an accessory 9
- Consistency of grind
 - Grinder adjustment switch 3
- Contact details 26
- Cover
 - Filler funnel for ground coffee 3
 - Water tank 3
- Cup detection
 - Coffee Eye 8
- Cup grille 3
- Customer support 26

D

- Damage
 - Preventing damage 5
 - What to do in the event of damage 4
- Declaration of Conformity 26
- Descaling
 - Machine 19
 - Water tank 20
- Display
 - Cockpit 8
 - Touch display 3
- Display messages 21
- Disposal 22
- Drip tray 3
 - Insert 3

E

- Emptying the system 22
- Errors
 - Troubleshooting 21
- Espresso 9
- Espresso doppio 11
- EU Declaration of Conformity 26

F

- Filler funnel
 - Filler funnel for ground coffee 3
- Filling
 - Bean container 6
 - Water tank 13
- Filter
 - Changing 17
 - Inserting 17
- Fine foam frother
 - Professional fine foam frother 3
- First-time use 6
- Flat white 11

G

- Grinder adjustment switch 3
- Ground coffee 11
 - Measuring spoon for ground coffee 3
- Grounding point 23

H

- Height-adjustable coffee spout 3
- Hotline 26
- Hot water 12
- Hot-water spout 3

I

- Insert for drip tray 3
- Instant coffee
 - Ground coffee 11

J

- JURA
 - Contact details 26

L

- Latte macchiato 11
- Lungo 11

M

- Macchiato 11
- Machine
 - Cleaning 18
 - Descaling 19
 - Rinsing 15
 - Setting up 6
- Machine settings 14
- Mains cable 3
- Maintenance 15
- Maintenance actions 14
- Measuring spoon for ground coffee 3
- Messages, display 21
- Milk 11
 - Connecting milk 8
- Milk foam 11
- Milk system 23
 - Clean 16
 - Professional fine foam frother 3
 - Rinsing 15
 - Syrup attachment 3, 10
- Milk system rinsing 15

P

- Preparation 9, 11
 - Americano 11
 - Caffè latte 11
 - Cappuccino 11
 - Coffee 9
 - Espresso 9
 - Espresso doppio 11
 - Flat white 11
 - Ground coffee 11

- Hot water 12
- Latte macchiato 11
- Lungo 11
- Macchiato 11
- Milk 11
- Milk foam 11
- Speciality Selection 9
- Sweet latte 10
- Problems
 - Troubleshooting 21
- Product settings
 - Adjusting 12
- Professional fine foam frother 3
 - Dismantling and rinsing 16
- Proper use 4
- R**
 - RFID 23
 - Rinsing
 - Machine 15
- S**
 - Safety information 4
 - Service socket 3
 - Setting up
 - Setting up the machine 6
 - Speciality Selection
 - Extra Shot 9
 - Ground coffee 9
 - Spout
 - Hot-water spout 3
 - Sweet latte 10
 - Switching off 13
 - Switching on 13
 - Symbol description 4
 - Syrup attachment 3, 10
- T**
 - Technical data 23
 - Milk system 23
 - Tel 26
 - Touch display 3
 - Transport 22
 - Troubleshooting 21
- U**
 - Use, First-time 6
 - Users 4
- W**
 - Water hardness
 - Determining the water hardness 6
 - Water tank 3
 - Descaling 20
 - Filling 13
 - WiFi 23
 - WiFi Connect 3, 9
 - WiFi connection 9
 - Wireless connection 9, 17, 23

13 JURA contact details / Legal information

JURA Elektroapparate AG
Kaffeeweltstrasse 10
CH-4626 Niederbuchsiten
Tel. +41 (0)62 38 98 233

- i** You can find additional contact details for your country at [jura.com](https://www.jura.com).
- i** If you need assistance with using your machine, you can find this at [jura.com/service](https://www.jura.com/service).
- i** Your opinion is important to us! Use the contact details at [jura.com](https://www.jura.com).

Directives

The machine complies with the following directives:

- 2014/35/EU – Low Voltage Directive
- 2014/30/EU – Electromagnetic Compatibility
- 2009/125/EC – Ecodesign Directive
- 2011/65/EU – RoHS Directive
- 2014/53/EU – Wireless Voltage Directive

A detailed EU Declaration of Conformity for your J8 can be found at [jura.com/conformity](https://www.jura.com/conformity).

Technical changes

We reserve the right to make technical changes. The diagrams used in these instructions for use are for illustration purposes only and do not represent the original colours of the machine. Some details of your J8 may vary.