



DeLonghi

DEDICA DeLuxe Get Started

This short guide is not intended to explain all the functions of the appliance. Please read all the owner's instruction booklet before use.



EC685

WELCOME

Introducing the exclusive world of espresso through the global leaders, De'Longhi. Based in Treviso, Italy, we grew up appreciating the taste and aroma of a good cup of coffee.

Discover the barista brewing inside you: now you can make authentic espressos, lattes and cappuccinos to suit your taste, in the comfort of your kitchen. Enjoy!



PUMP ESPRESSO TIPS AND TRICKS

Recommendations for producing a better espresso:

1. Use freshly ground espresso.
2. Store coffee beans in a cool, dark and dry container. Vacuum sealed if possible.
3. Pre-heat your espresso and cappuccino cups using the cup warmer storage on the top of the machine.
4. Ensure your first coffee is the ideal temperature by pre-warming the filter / filter holder before making coffee. Simply fit the filter / filter holder (without coffee) into the machine and place a cup underneath. Select the single cup option and 'purge' the machine allowing hot water to pass through the filter into the cup.
5. Use one level scoop of freshly ground coffee for best results. This is roughly 7 grams.
6. Tamping the coffee is recommended to produce an even compact bed of coffee for brewing.
7. Tamping is important as applying too little pressure will cause the coffee to be weak (under extracted) and applying too much pressure may result in thick, burnt coffee (over extracted).
8. Grind size can affect the brew strength. If coffee is ground too coarse, then coffee will flow too quickly and be weak (under extracted). Coffee that is ground too fine will flow slowly and may be thick or burnt (over extracted).
9. Remove any residual coffee grounds from the filter / filter holder rim before placing into the machine for brewing.

Recommendations for producing a better cappuccino or latte:

1. Once steam has been selected 'purge' the steam nozzle/frother to eliminate any excess water before you start frothing the milk.
2. Always use fresh, cold milk. Some milks that do not require refrigeration will not produce an acceptable foam.
3. Once you have frothed the milk tap the jug on the counter to remove any large air bubbles
4. 'Spin' or swirl the milk to ensure the milk and foam combine a little and to give it a glossy finish.
5. Pour the milk/foam immediately after spinning/swirling to ensure that milk and foam do not separate.



IN THE BOX

- A1. Water tank lid
- A2. Water tank
- A3. Cup warmer
- A4. Control panel buttons
- A5. Steam dial
- A6. Water spout / frother
- A7. ON/OFF switch
- A8. Drip tray

- B1. Filter-holder with 3 cups
- B2. Tamper/dispenser measure scoop

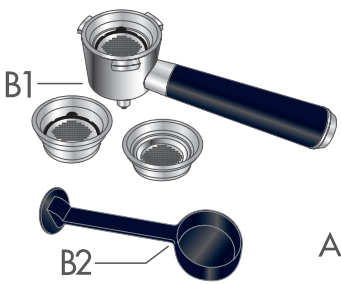

Get Started & Owner's Instructions Booklets

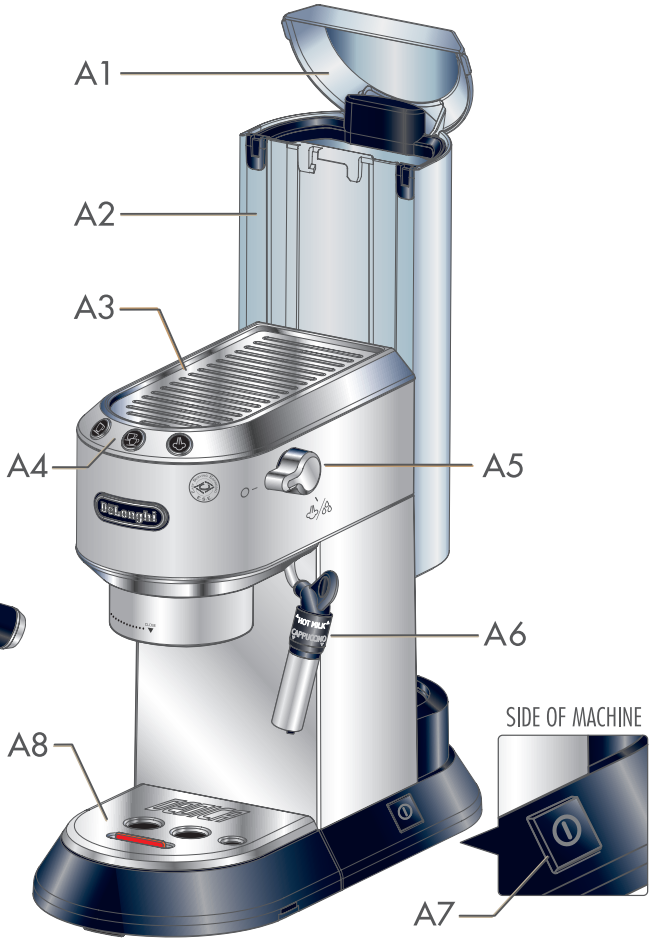

"Total Hardness Test" Indicator



Natural Descaler
100ml / 3.4 oz.
Sold Separately

MACHINE SET UP

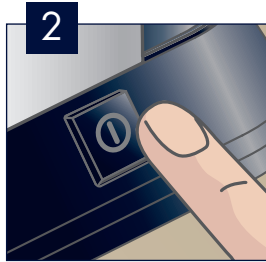
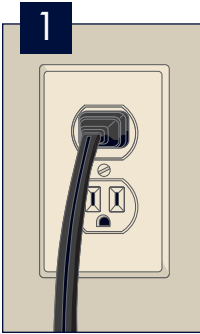

Main switch on side of machine.

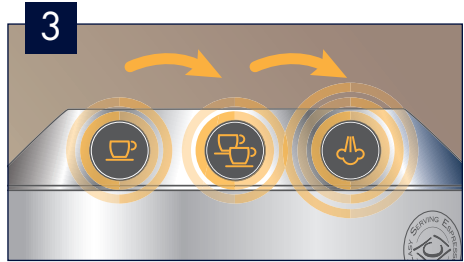

The machine performs a self-test signalled by the sequential flashing of lights.



The machine is warming up, when lights stop blinking the machine is almost ready for use.

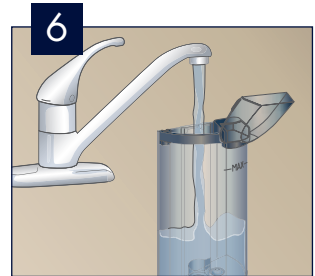
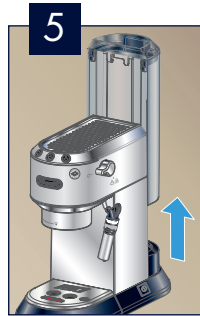

Fill water tank

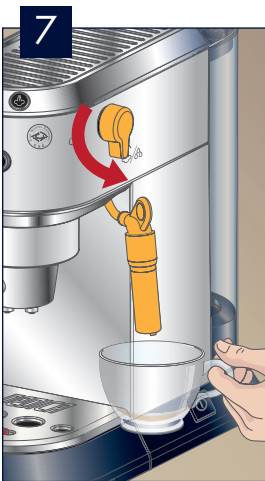

Turn the steam dial to the ☕/☕ position. The machine will prime and a little water will be released.



Turn the steam dial to the ○ position. The machine is ready for use.

Machine is now ready to work!

BREWING ESPRESSO Using Pre-Ground Espresso

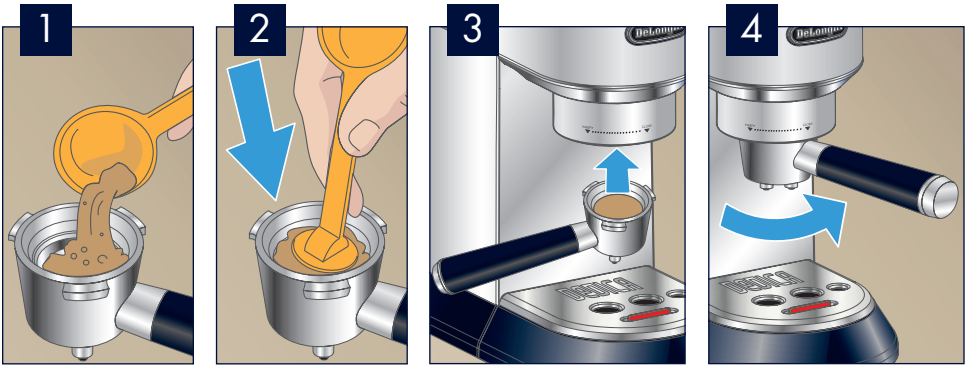

Use correct filter,
marked on bottom of cup.

1 CUP  2 CUPS 

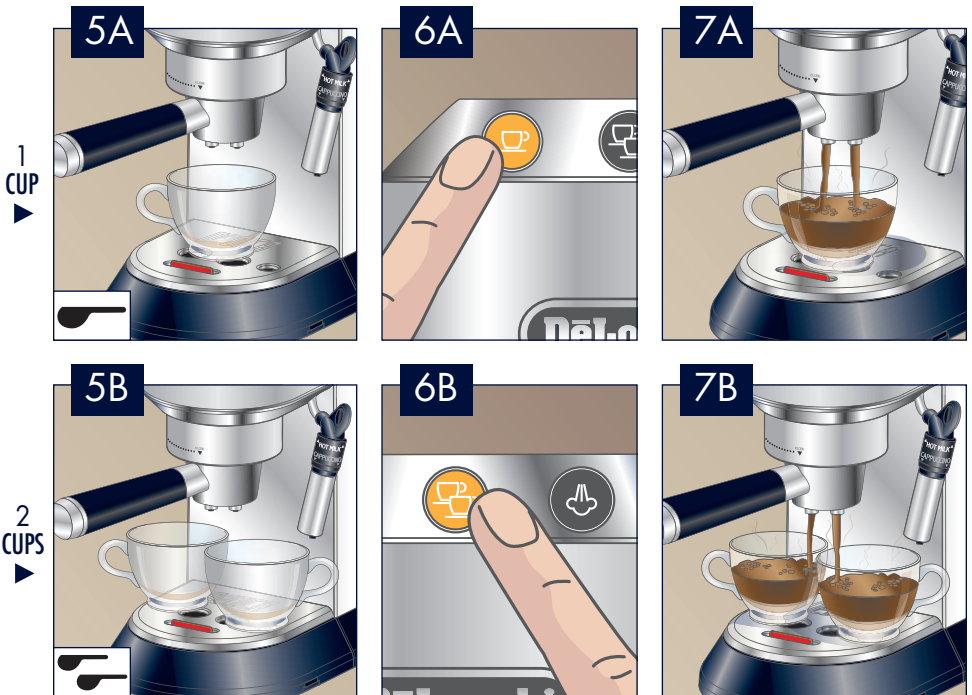

Brew 1 or 2 Espresso at one time.



BREWING ESPRESSO Using E.S.E. POD Espresso

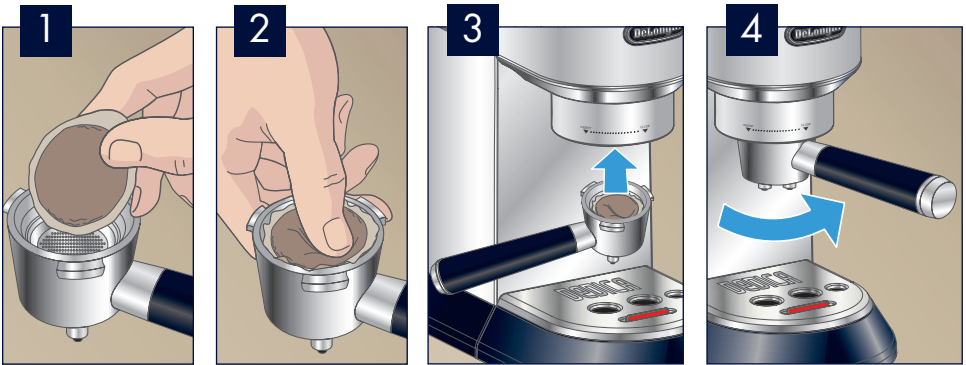

Use correct filter, marked on bottom of cup. E.S.E. POD 

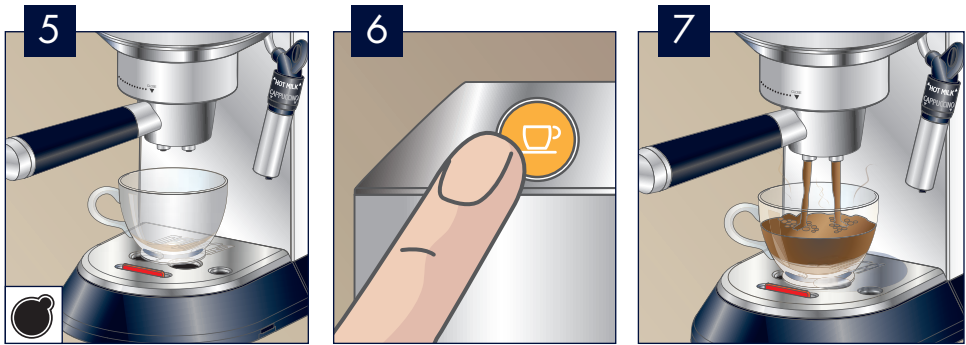

E.S.E. (Easy Serving Espresso) Pods can be used to simplify the espresso preparation. Each pre-packed pod contains 7 grams of coffee, already measured and pressed and sealed between 2 fine layers of filter paper.



BREWING CAPPUCCINO or LATTE

Refer to previous section BREWING ESPRESSO for the espresso related part.



Hot Milk steamed, no foam



Cappuccino creates foam



Fill the pitcher, 3.5 oz. for Cappuccino, 6 oz. for Latte.

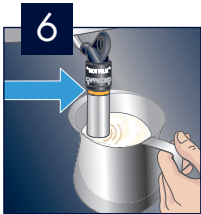
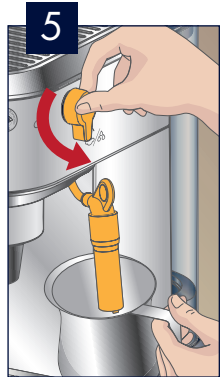
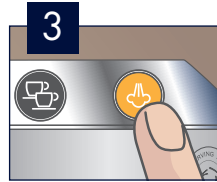

Be sure frother is immersed in milk, but not beyond the highlighted mark on the spout



Froth until desired level of foam is reached, then turn dial to  position.



If both coffee buttons are blinking, you must cool down the boiler.

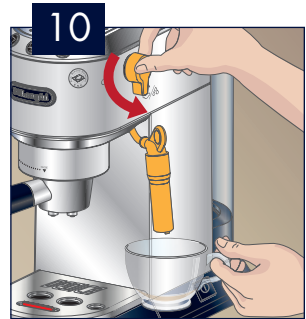

Turn dial ON allowing water to be delivered. When water stops, turn dial to  position.



Prepare the coffee as described in the previous section. Brew in a larger cup.



Pour the milk over the espresso and enjoy!

Tip for the BEST CAPPUCCINO:

Use Skim or 2% Milk at Refrigerator Temperature (about 41°F/5°C)

Delivering hot water

1. Place a container under the spout (as close as possible to avoid splashes).
2. Turn the steam dial to the ☞/💧 position. Water runs out of the spout.
3. Turn the dial to the ○ position when the desired amount of water has been delivered.
NOTE: You can stop the flow of water by pressing the button.
(You should not run off hot water for more than 2 minutes at a time).
4. Press any button.

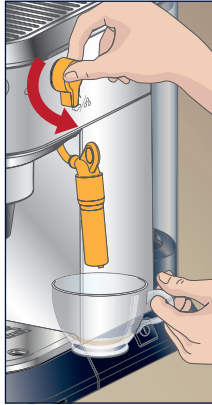

Important! Danger of burns.

Never leave the machine unsupervised while delivering hot water or steam. The spout becomes hot during delivery. Hold by the handle only.

Installing the filter*

* Optional water filter sold separately.

1. Remove the filter from packaging and rinse the filter with about half a liter of tap water.
2. Rotate the calendar disk (A) so that the next two months are displayed.
3. Remove the tank from the appliance and fill with water.
4. Insert the filter (B) in the water tank and immerse it completely for ten or so seconds, sloping it to enable the air bubbles to escape.
5. Insert the filter in the filter housing (C) and press as far as it will go.
6. Close the tank with the lid (D), then replace the water tank in the machine.
7. The new filter is active. You can now use the coffee maker.

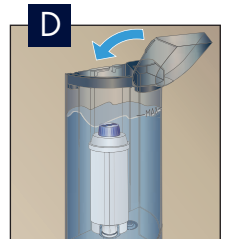
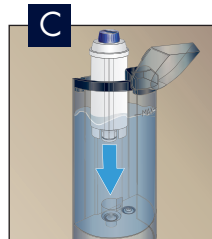
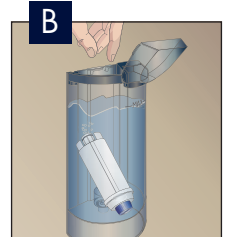
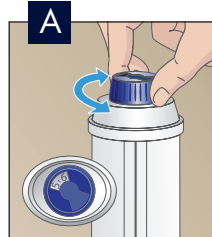

Please note! The filter lasts about two months if the appliance is used normally. If the coffee maker is left unused with the filter installed, it will last a maximum of three weeks.

TEST YOUR WATER

Measuring Water Hardness

1. Remove the "total hardness test" indicator paper from the pack.
2. Immerse the paper completely in a glass of water for one second.
3. Remove the paper from the water and shake lightly. After about a minute, 1,2,3, or 4 red squares form, depending on the hardness of the water. Each square corresponds to one level.



Press  button and hold for 10 seconds. The lights will blink in sequence. You are now in the setting menu.



Press the  button to enter the water hardness setting.

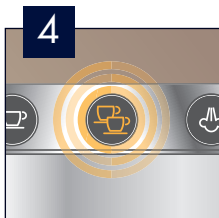

The button indicates that the selection has been saved.

Choosing the water hardness is very important to set the correct frequency of the descaling cycles. Keeping the machine clean will improve its performance and prolong the life of the machine.

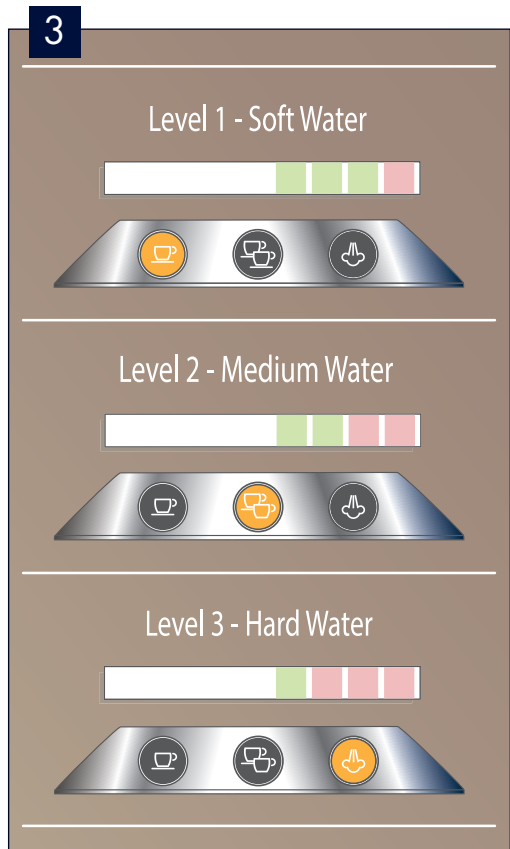

Press the button that corresponds to the correct hardness level.

CLEANING and MAINTENANCE: FROTHER



1 Unscrew the frother by rotating counter-clockwise and pulling downwards.

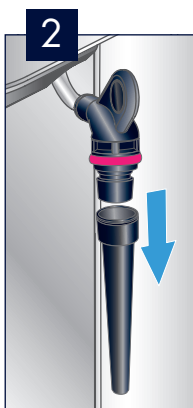

2 Remove the nozzle from the steam tube by pulling it downwards.



3 Thoroughly clean steam nozzle with cloth and warm water.

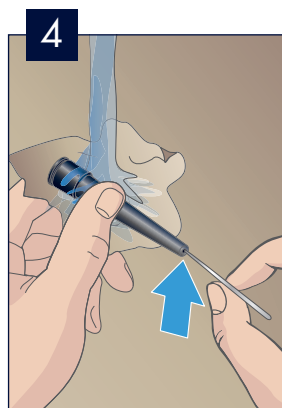

4 Clean nozzle with warm running water and use a needle to clean the hole.

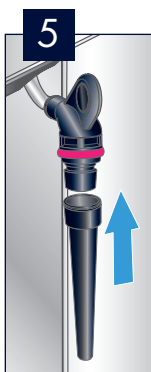

5 Replace the nozzle by inserting it onto the steam tube.

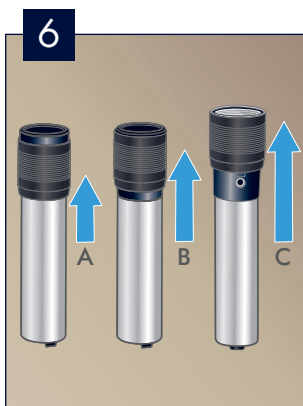

6 To clean the hole in the frother, pull up the selection ring as in figure C until the hole appears.

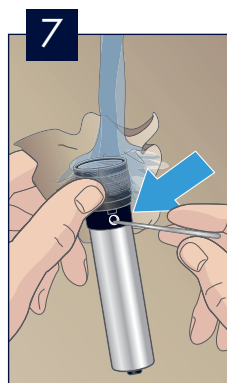

7 Clean frother with warm running water and use a needle to clean the hole. After cleaning, push down selection ring as in figure A or B.

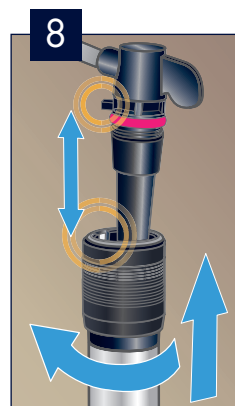

8 Replace the frother by first aligning the frother notch with the nozzle tab, then insert and rotate clockwise into place.

Frother and steam nozzle parts can be cleaned thoroughly by using De'Longhi Milk Clean.

CLEANING THE COFFEE FILTERS

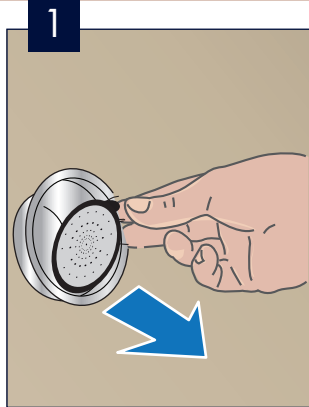

Extract the removable perforated filter



Clean the filter with warm running water



Clean with a brush







Clean the hole on the bottom with a toothpick

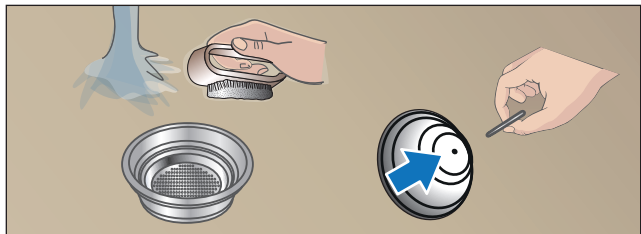







Insert the perforating filter pushing it as far as it goes



Descale the machine when the  orange light comes on.

1. Turn the machine on.
2. Completely empty the water tank (A) and remove the water filter (if present).
3. Fill the tank with the descaler solution obtained by diluting the descaler (B) with water (C): fill the water tank up to the MAX level.
4. Place an empty container (D) with a minimum capacity of 50 oz under the hot water spout and brewing unit.
5. Press the  button and hold for 10 seconds. The lights will blink in sequence. You are now in the setting menu.
6. Turn the steam dial to  and press  button. The descaling program automatically performs a series of deliveries at intervals to remove the lime scale from inside the coffee machine.

7. From time to time turn the steam dial to the  position to deliver small quantities of descaler from the brewing unit.
8. Once the water tank is empty, the  orange light starts blinking.
9. To remove the solution and lime scale residues, rinse the tank and fill it with fresh water (without descaler); empty the containers and place them under the boiler outlet and hot water spout.
10. Turn the steam dial to  the position and press the  button to start the rinsing.
11. From time to time turn the steam dial to the  position to deliver small quantities of water from the boiler outlet.
12. Once the water tank is empty, turn the steam dial to  position.

The appliance is now ready for use.

Repairs to the coffee machine relative to lime scale problems are not covered by the warranty if the descaling procedure described above is not performed on a regular basis.

Important! Danger of Burns

Hot water containing acid flows from the spout. Avoid contact with splashes of water.

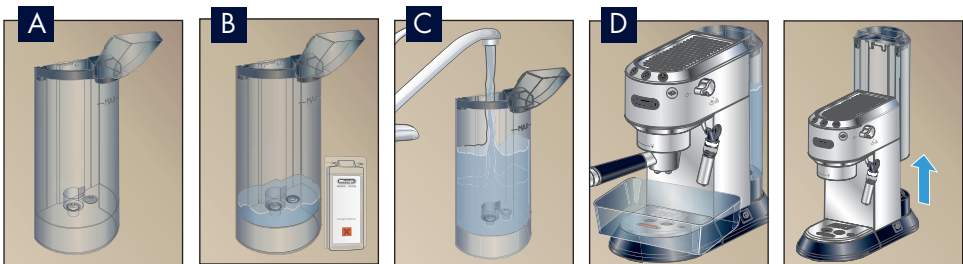

Important!

- Descaler contains acids which may irritate the skin and eyes. It is vital to respect the manufacturer's safety warnings given on the descaler pack and the warnings relating to the procedure to follow in the event of contact with the skin and eyes. Use De'Longhi descaler only. Under no circumstances should you use sulphamic or acetic based descalers. Their use invalidates the guarantee. Failure to descale the appliance as described also invalidates the guarantee.

ACCESSORIES

Enjoy our full line of drinkware:
an exclusive line of Espresso, Cappuccino, Latte glasses and milk pitcher.



Care Kit Line

Experience the De'Longhi Care Kit Line to improve the performance
of your espresso machine.



EcoDecalk



EcoDecalk mini



Water Filter



Coffee Care Kit



Milk Clean

... to learn more about the De'Longhi accessories visit: delonghi.com

ESPRESSO DRINKS



Espresso

A small 1 or 2 oz. shot of pressure brewed espresso using approximately 1 Tbsp. of finely ground coffee.



Cappuccino

A single espresso shot topped with equal parts steamed and frothed milk (in a ratio of 1:1:1) served in a 4 to 6 ounce cup.



Café Latte

A double espresso shot topped with steamed milk to fill; a ratio of 2:1 of milk to espresso is typical.



Caffè Mocha

This drink is made from layers of chocolate, milk, espresso and cream. Prepare hot, frothed milk. Let it cool. Pour the chocolate sauce in a different glass, carefully pour in the hot milk. Slowly add brewed espresso. Top off with whipped cream and garnish with chocolate flakes.

Ingredients: 1 oz. of espresso coffee
4 oz. of hot milk
1 – 2 tablespoons of cold chocolate sauce
Whipped cream
Chocolate flakes



Italian Macchiato

A single or double espresso topped with a dollop of heated milk and served in a traditional espresso cup.



Espresso Lungo

From 3 oz. up to 4 oz. of brewed espresso using finely ground coffee.



Americano

1/3 of espresso lungo and 2/3 of hot water.



Caramel Macchiato

A tasty variation of latte macchiato with the addition of caramel syrup. Pour the caramel syrup down the inside of the glass. Pour first the cold milk and then the whisked hot milk into the glass. Add the milk foam. Prepare the espresso and pour it into the glass. Add a bonnet of milk foam.

Ingredients: 1 oz. of espresso coffee
1 oz. of cold milk
5 oz. of hot milk
Caramel syrup

... more recipes at: coffeemakers.delonghi.us/coffee-recipes-0



www.delonghi.com

 like us: DeLonghi North America –  follow us @DeLonghiNA