

Register Now 
www.delonghi.com/register

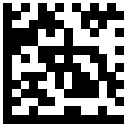

57132C7875_01_0522

EC9865

La Specialista

MAESTRO

COFFEE MAKER
Instructions for use

Instructions videos available at:
<http://EC9865.delonghi.com>



De'Longhi

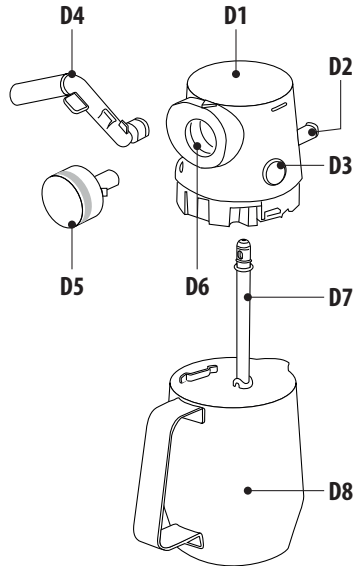
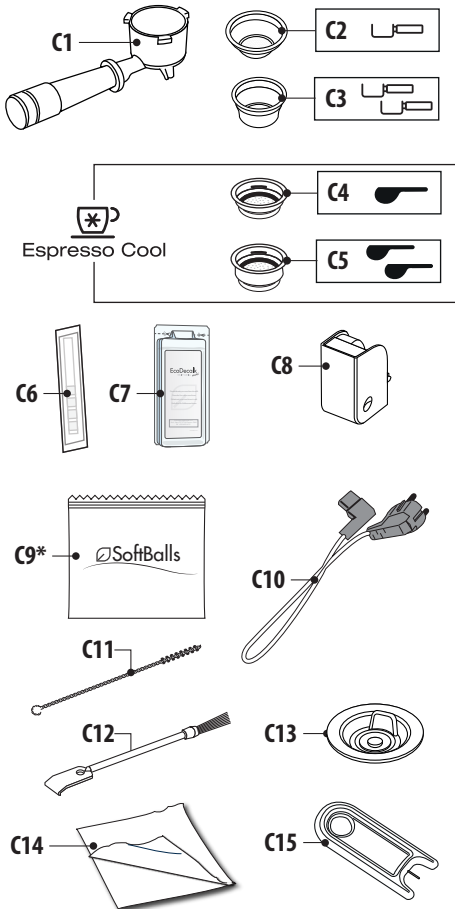
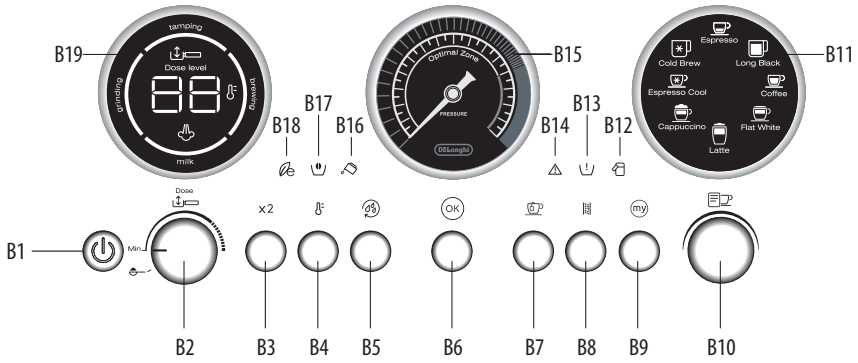

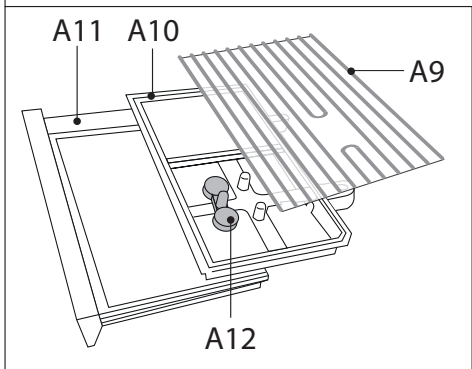
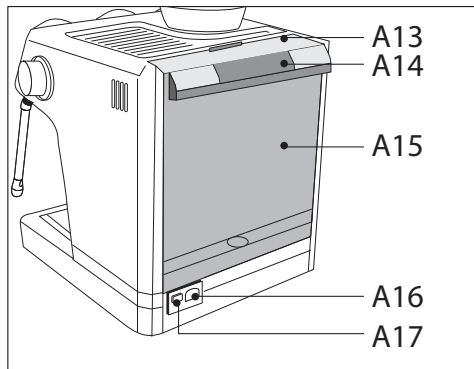
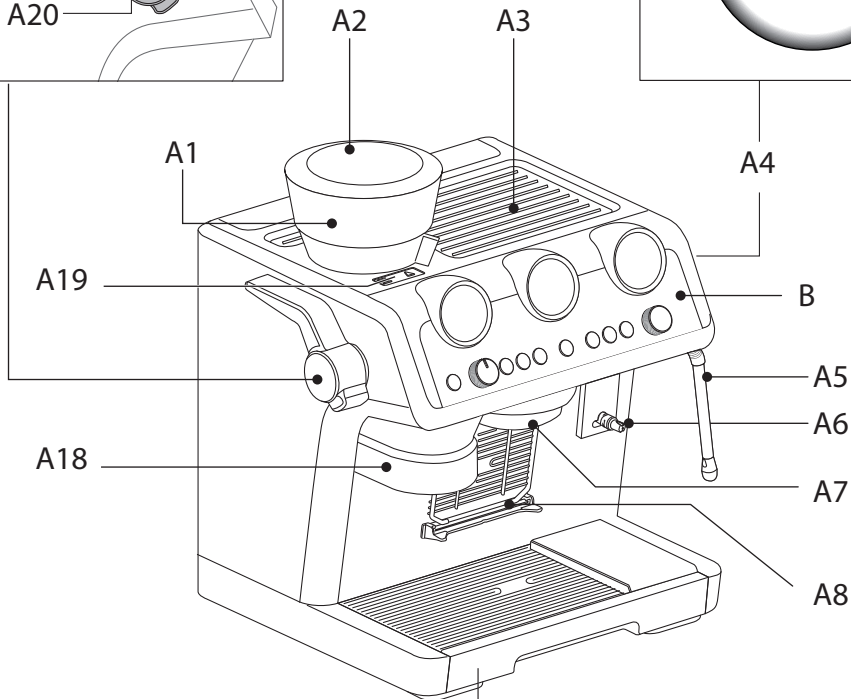
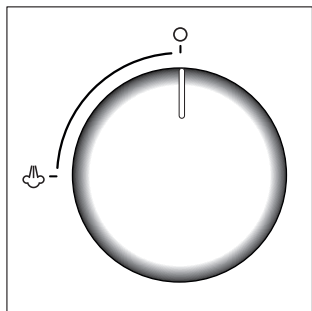
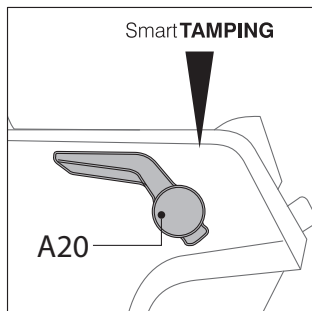

Before using the appliance, always read the safety warnings.

This appliance shall not be used by children.
Keep the appliance and its cord out of reach of children.

1. DESCRIPTION

1.1 Description of appliance - A

- A1. Beans container
- A2. Beans container lid
- A3. Cup tray
- A4. Steam dial
- A5. Steam wand
- A6. Lattecrema System connection
- A7. Coffee outlet
- A8. Cup grille for espresso
- A9. Cup grille for glasses or mugs
- A10. Drip tray grille
- A11. Drip tray
- A12. Drip tray water level indicator
- A13. Water tank lid
- A14. Water tank extraction handle
- A15. Water tank
- A16. Power cord connector socket
- A17. Main switch (ON/OFF)
- A18. Coffee grinder outlet (tamping station)
- A19. Cover to access the coffee grinder coffee guide
- A20. Presser lever

1.2 Description of control panel - B

- B1. ON/Standby button
- B2. Coffee dose dial
- B3. "X2" button: to use the 2 coffees filter
- B4. Coffee Temperature button
- B5. "Active Rinse" button
- B6. "OK" button: to deliver the drink/confirm
- B7. Hot water button
- B8. "Descaling" button
- B9. "My" button: to customise drink quantity
- B10. Drink selector dial
- B11. Drink selected light:

Espresso based drinks

- Espresso
- Long Black
- Coffee

Cold coffee drinks

- Cold Brew
- Espresso Cool

Milk based drinks

- Cappuccino
- Flat White
- Latte

B12. "Milk clean" light

B13. "No beans container" light

B14. "General alarm" light

B15. Pressure gauge

B16. "No water" light

B17. Beans container empty light

B18. "Energy saving" light

B19. Led module process:

- Indicates the operation the appliance is running
- The setting of the dose level
- The infusion temperature setting

1.3 Description of accessories - C

C1. Portafilter

C2. 1-cup coffee filter

C3. 2-cups coffee filter

Dedicated filters for **Espresso Cool** :

C4. 1-cup coffee filter

C5. 2-cups coffee filter

C6. "Water hardness test" indicator paper

C7. Descaler

C8. Descaling accessory

C9. Softballs (*some models only)

C10. Removable power cord

C11. Tube brush

C12. Brush / Scraper tool

C13. Coffee outlet cleaning disk accessory

C14. Cloth

C15. Cleaning needle for steam wand

1.4 Description of LatteCrema System - D

D1. Milk container lid

D2. Milk container connector

D3. Lid release button

D4. Milk spout (adjustable height)

D5. Froth selection knob

D6. Knob housing

D7. Milk intake tube

D8. Milk container

1.5 Optional cleaning accessories













Visit Delonghi.com for more information.









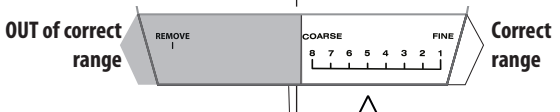





Cleaning tab

(see "5.3 Coffee filter cleaning and maintenance")

2. EXPLANATION OF LIGHTS

LIGHTS	EXPLANATION OF LIGHTS	OPERATION
All the lights flash briefly	Turning the machine on	Self-diagnosis
 on	The appliance is being turned on for the first time and the water circuit must be filled	Proceed as described in section "Setting la specialista for first use" of the quick guide.
 on (white)	The machine is ready for hot drinks delivery	Prepare the machine and proceed with delivery
 on (blue)	The machine is ready for cold drink delivery	Prepare the machine and proceed with delivery
 on	Energy saving is enabled	If you want to disable the function, see section "3. Menù settings"
 on	The beans container is empty	Fill the beans container
 flashing	You are trying to deliver a drink but the beans container is empty	Fill the beans container
 on	Insufficient water in tank or water tank not inserted correctly	Fill the tank or extract the tank and put it back correctly
 flashing	You are trying to deliver a drink but water tank is empty	Fill the tank
 on	General alarm	Contact Customer Services
 on	The bean container is not inserted	Insert bean container or check that it is completely locked. The container is correctly inserted when the arrow is lined up with the  symbol and you hear a "click".
 flashing	The fines of the grind regulation is incorrect (or out of correct range)	Move the selector within the 8 levels from coarse to fine, keeping in mind to: <ul style="list-style-type: none"> • Always adjust the coffee grinder during the grinding • Adjust one grinding level at a time and make at least 5 coffees before adjusting again
		
	The coffee bean container is not completely insert: the machine does not work for safety reasons	Check that the bean container is completely locked (see fig. 15)

...→

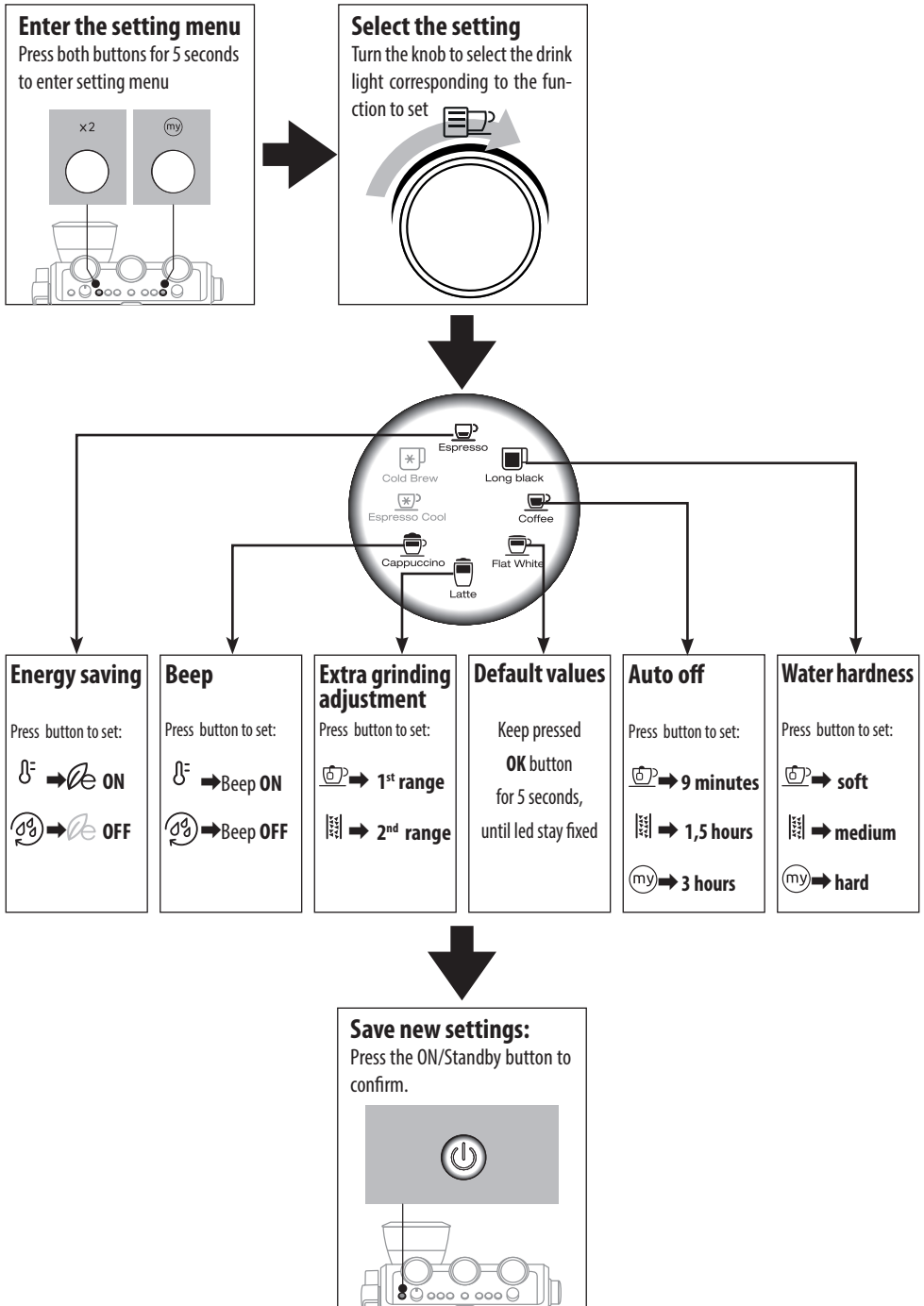

LIGHTS	EXPLANATION OF LIGHTS	OPERATION
 on	After every use, the LatteCrema System must be cleaned	When all the milk drinks are ready, proceed with automatic cleaning turning the knob to Clean
 on	The appliance is on and ready for use	The appliance is at the right temperature to deliver steam. To deliver steam, turn the steam dial (A4)
 flashing	The appliance is on and energy saving is enabled. The steam dial (A4) is in the steam delivery position	The light flashes to indicate that the appliance is preparing to deliver steam. Delivery begins as soon as the appliance is at temperature
	The appliance is heating up to be ready for use	The appliance is at temperature when the light remains on steadily
	The appliance is delivering steam	
 on (orange)	Descaling must be performed	Descalc the appliance as described in section "8. Descaling"
 flashing (orange)	Descaling is underway	Complete the operation as described in section "8. Descaling": the light comes white when the rinsing cycle of descaling is underway
 on (white)	The rinsing cycle of descaling must be performed	
 flashing (white)	The rinsing cycle of descaling is underway	
 on (orange)	Cleaning of the coffee outlet must be performed	See section "5.5 Cleaning of the coffee outlet"
 flashing (orange)	Cleaning of the coffee outlet is underway	
 flashing (white)	The active rinse is underway <ul style="list-style-type: none"> • Cold rinse when Espresso Cool or Cold Brew are selected, • Hot when all other recipes are selected. 	
 +  flashing	If the water softener filter (optional) is present, an air bubble may have been released inside the circuit, obstructing delivery	Press the button (B7) corresponding to the  light. Delivery begins and stops automatically.
	The grinding is too fine and the coffee is delivered too slowly or not at all	Extract the filter holder and repeat the operations to make the perfect dose (see Quick Guide - Step 1 Grinding).
	The coffee filter is blocked.	Clean as described in section "5.3 Coffee filter cleaning and maintenance".
	The tank has been inserted incorrectly and the valves on the bottom are not open	Press the tank down lightly to open the valves on the bottom
	Scale in the water circuit	Descalc as described in section "8. Descaling"

3. MENU SETTINGS



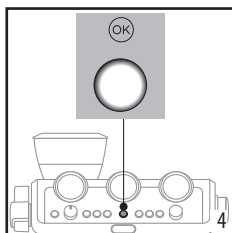
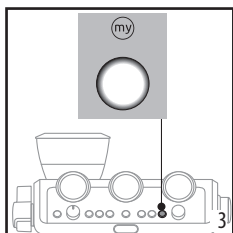
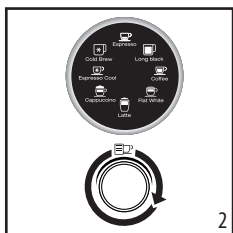
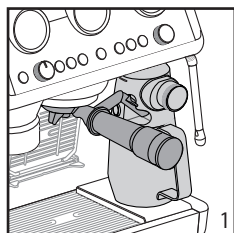

4. CUSTOMISING THE QUANTITY OF COFFEE DRINKS WITH THE BUTTON (B9)

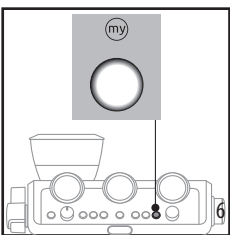
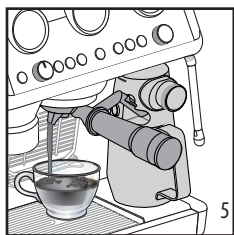

1. Prepare the appliance to deliver the drink you want to make. Prepare the coffee dose and attach the portafilter to the coffee outlet: if you have to customise a milk based drink, prepare and also attach the Lattecrema System .
2. Turn the dial (B10) to select the drink to be programmed.
3. Press the  button: the light corresponding to the OK button (B6) comes on steadily and the light corresponding to the function flashes.
4. Press the OK button to start delivering the drink. The lights corresponding to the OK and  buttons flash.



5. When you have reached the desired quantity of the drink, press the OK button again. If the recipe includes another ingredient, it starts delivery: when you have reached the desired quantity, press the OK button again.
6. Press the  button to save the new setting. The appliance is ready for use again and the  button remains on.
If you do not want to save the new setting, press any other button.





Please note:





- You can programme coffee drinks, but not steam and hot water.
- Programming changes the quantity of the drinks, but not the amount of coffee ground.
- "X2" drinks can be programmed separately.
- **My LatteArt**  is not programmable.

4.1 Reset „my“ to default values

If you want to reset the quantity to default values, proceed as follows:

1. Select the drink you want by turning the selector dial (B10);
2. Keep pressed the  button (B9) until it switches off. The quantity is restored to default value.

Coffee Recipe	Default quantity	Programmable quantity
 Espresso	35 ml	from 25 to 90 ml
 Espresso X2	70 ml	from 50 to 180 ml
 Coffee	80 ml	from 50 to 120 cc
 Coffee X2	160 ml	from 120 to 240 ml
 Long Black	100 ml	<ul style="list-style-type: none"> • water: from 25 to 120ml • espresso: from 25 to 60 ml

Coffee Recipe	Default quantity	Programmable quantity
 X2	200 ml	<ul style="list-style-type: none"> • water: from 50 to 240 ml • espresso: from 50-120 ml
 Cold Brew	110 ml	from 90 to 130 ml
 X2	180 ml	from 160 to 220 ml
 Espresso Cool	40 ml	from 30 to 50 ml
 X2	80 ml	from 60 to 110 ml











5. CLEANING AND MAINTENANCE

Important!

- Do not use solvents, abrasive detergents or alcohol to clean the coffee machine.
- Do not use metal objects to remove encrustations or coffee deposits as they could scratch metal or plastic surfaces.
- None of the components of the appliance can be washed in a dishwasher with the exception of the drip tray (A11), cup grilles (A8) and (A9), Lattecrema System (D) with the exception of the milk container (D8).
- If the appliance is not used for more than a week, before using it again, we recommend you perform a rinse cycle.

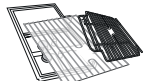
Danger!

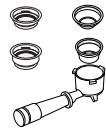
- While cleaning, never immerse the coffee maker in water. It is an electrical appliance.
- Before cleaning the outside of the appliance, turn it off, unplug from the mains socket and allow to cool.

					
	×	✓	✓	×	×
	✓	×	×	✓	✓
	×	×	×	✓	✓
	×	×	✓	✓	×
	×	×	×	✓	✓
	✓	✓	×	✓	✓
	×	×	✓	✓	✓

5.1 Cleaning the drip tray

The drip tray is fitted with a level indicator (A12) (fig. 7) showing the amount of water it contains. Before the indicator protrudes from the cup tray, the drip tray must be emptied and cleaned, otherwise the water may overflow the edge and damage the appliance, the surface it rests on or the surrounding area.

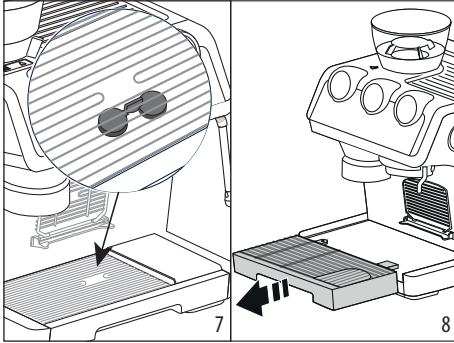

1. Remove the drip tray (fig. 8).
2. Remove the cup grille (A9), drip tray grille (A10) and level indicator (A12), empty the water and clean all the components with a cloth, then reassemble the drip tray.
3. Put the drip tray back in place.

5.2 Cleaning the espresso cup grille

1. Extract the grille (A8) by pulling it from the left, then removing it from the support (fig. 9).
2. Clean the support with a cloth and wash the grille (dishwasher safe).
3. Put the grille back on the support from the right side, then push until it is correctly attached (fig. 10).

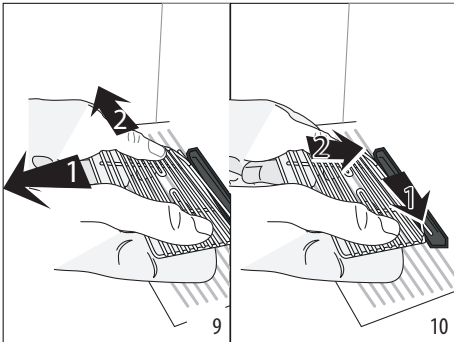

5.3 Coffee filter cleaning and maintenance

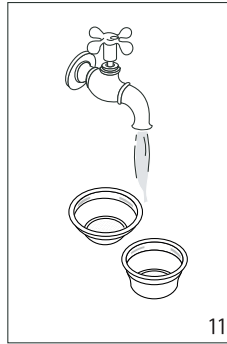

For best results, the filters must always be clean and free from all coffee residues. Always rinse the filters under abundant running water (fig. 11) or by Active Rinse function (B5).

5.4 Cleaning the "Espresso Cool" filters

These filters have been developed to deliver optimal extraction results with this recipe. For best results, the filters must always be clean and free from all coffee residues.

After using the appliance, use the scraper tool (C12) to remove the exhausted coffee dose. Always rinse the filters under abundant running water (fig. 12), pushing the perforated filter to make sure it is always correctly inserted in its housing (fig.14);

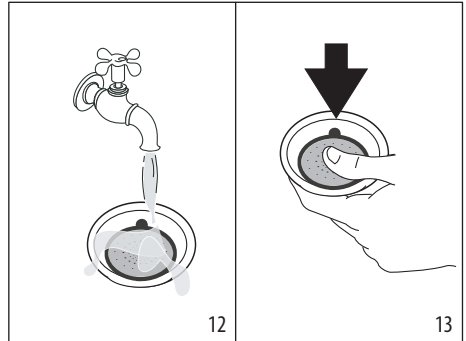

make sure the hole underneath (shown in fig.14) is free from all residues.

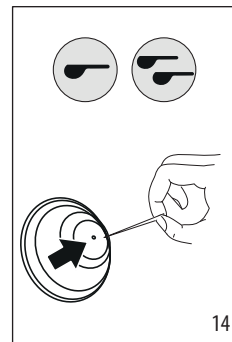

If still dirty, and in any case always at least once a month, clean the coffee filters thoroughly:

1. Extract the perforated filter by pulling the tab (fig. 15).

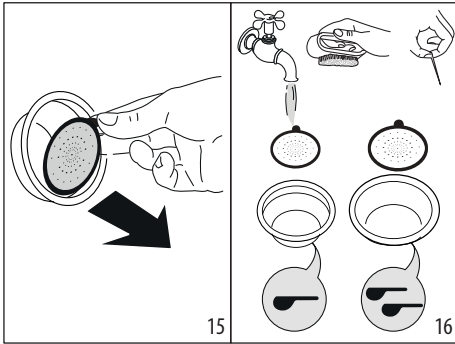

2. Rinse the filters under running water (fig. 12).
3. Make sure the holes are not blocked. If necessary, clean with a pin (fig. 14-16).
4. Dry all the components with a cloth.
5. Put the perforated filter back in the housing and press as far as it will go (fig. 13).

5.5 Cleaning of the coffee outlet

When the ☹️ light comes on (orange) (B5), you have to proceed cleaning the coffee circuit. To run the cleaning, you have to purchase dedicated cleaning tabs for coffee makers. For more info, please visit Delonghi.com.

Proceed as follows:

1. Insert the 1-cup coffee filter (C2) in the portafilter (C1);
2. Put on the coffee filter the special disk accessory (C13) (fig. 17) and press it to the bottom;
3. Put on the accessory the cleaning tab (fig. 18);
4. Attach the portafilter to the coffee outlet (A7);

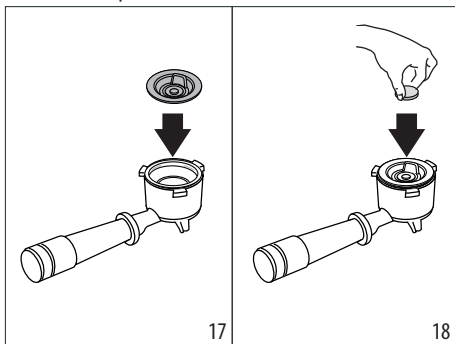

5. Fill the water tank (A15);
6. Keep pressed the ☹️ button, until the related light start blinking (orange): after few minutes the cleaning stops automatically;
7. When the ☹️ light turns steady white, remove the portafilter and the disk accessory;
8. Wash the portafilter and filter under running water;

9. Attach the portafilter to the coffee outlet and proceed rinsing by pressing the ☹️ button. We recommend to put a container under the portafilter to collect the water.
10. Once rinsing is complete, the machine is ready to use.
11. Remove and empty the drip tray.

Please note:

- The cleaning cycle can be run whenever you want by keeping pressed the ☹️ button for a few seconds. To cancel the operation, press the ☹️ button for 10 seconds. The rinsing process can not be deleted.
- Once finished the cycle, be sure to remove the disk accessory!

5.6 Cleaning the water tank

1. Remove the Softballs pack (*if present) and rinse with running water.
2. Clean the water tank regularly (about once a month) with a damp cloth and a little mild washing up liquid, then rinse thoroughly.
3. Place back the softballs bag (*if present), fill the tank with fresh water and replace the tank.

Danger!

While cleaning, never immerse the coffee maker in water. It is an electrical appliance.

5.7 Cleaning the beans container

Without extracting it, clean the beans container regularly with a cloth. For more thorough cleaning, proceed as follows:

1. Make sure the beans container (A1) is empty. If necessary, operate the coffee grinder without beans to empty it;
2. Release the beans container by turning it anticlockwise and extract from the appliance;
3. Wash the container and lid (A2) with warm water. Do not wash the components in a dishwasher or use washing up liquid! Dry all accessories thoroughly before using again.
4. Remove coffee residues (fig. 19) using a vacuum cleaner;
5. Clean the beans container housing with a damp cloth and dry;
6. Put the container back inserting it in the coffee grinder (fig. 20). The container is correctly inserted when the arrow ▲ is lined up with the 🔒 symbol and you hear a "click".

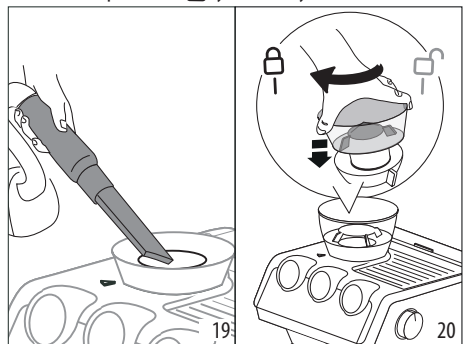

5.8 Cleaning the burrs

When cleaning the beans container, clean the container housing and upper burr with a damp cloth. The burr can be removed and replaced by an authorised customer services centre.

You may also need to remove the burr if it becomes blocked with foreign matter. If this occurs, clean as follows:

1. Empty the beans container (if necessary, using a vacuum cleaner to remove any remaining beans).
2. Attach the portafilter and operate the grinder without beans to free the coffee guide, then attach the portafilter to the outlet of the coffee grinder (A18), lining it up with "INSERT", then turning it to the right. Grinding begins when the portafilter reaches the CLOSE position and stops automatically;
3. Turn the appliance off;
4. Release the beans container by turning it anticlockwise and extract from the appliance;
5. Turn the grinding selector anticlockwise as far as it will go to the "REMOVE" position (fig. 21).

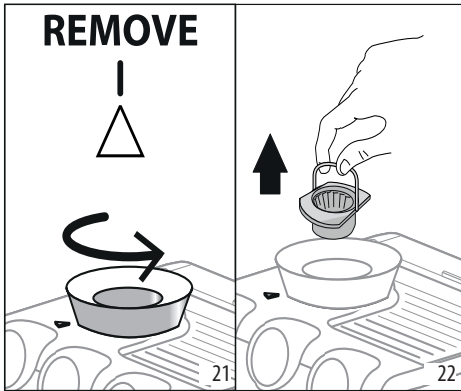

6. Extract the upper burr, gripping it by the handle (fig. 22).
7. Clean the burr with the brush (C12) (fig. 23) and remove the coffee residues using a vacuum cleaner (fig. 19).
8. Put the upper burr back in place:

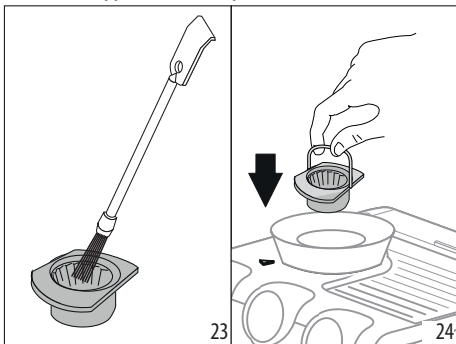

9. Insert the burr in its housing (fig. 24);

10. Turn the selector to select the desired grinding level (fig. 25);
11. Make sure the burr is inserted correctly by pulling it by the handle. If it is correctly inserted, it will not move;

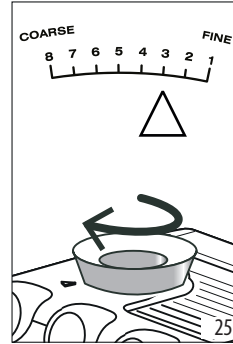

12. Clean the beans container housing with a damp cloth and dry;
13. Put the container back (fig. 20).

5.9 Replacing the burrs

When the quantity of coffee becomes even less, contact a customer services centre to have the burrs replaced, then adjust the grinder again as follows entering the setting menu ("3. Menu settings") and selecting the first range of the "Extra grinding adjustment". Then turn the ground coffee quantity dial (B2) to minimum position and set the dose like a first use (see Quick Guide).

5.10 Cleaning the "Smart tamping station"

To guarantee top quality grinding, clean the "Smart tamping station" regularly as follows:

1. Clean the attachment area with the brush (C12) (fig. 26).

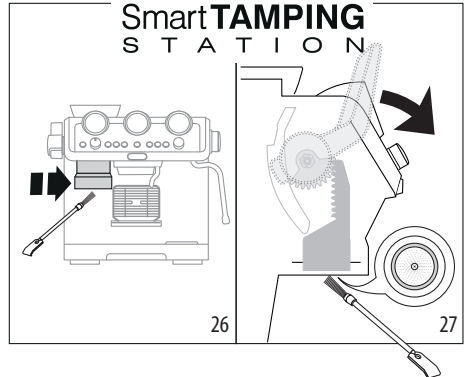

Pull the lever (A20) as far as it will go and clean the internal tamper with a brush (fig. 27). Then release the lever.

Use the tube brush (C11) to clean the coffee funnel (fig. 28).

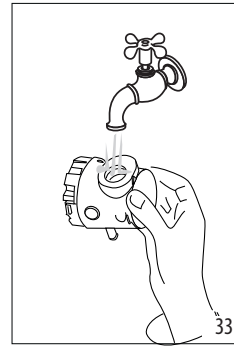
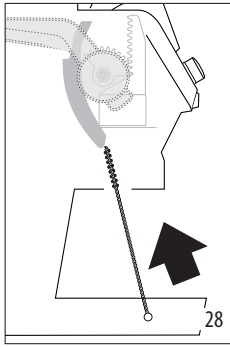

5.11 Cleaning the LatteCrema System

Clean the milk container each time you prepare milk as described below:

1. Push the release button (D3) and lift the milk container lid (D1) (fig. 29);
2. Remove the milk spout (D4) and milk intake tube (D7) (fig. 30);

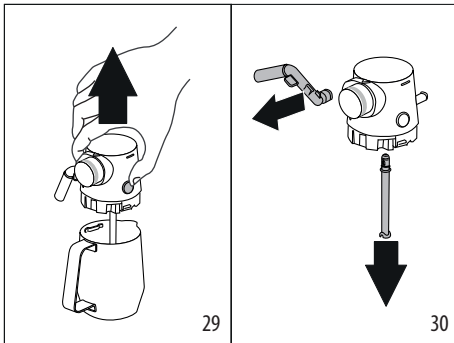

3. Turn the froth adjustment dial (D5) counter-clockwise to the "Insert" position (fig. 31) and pull;

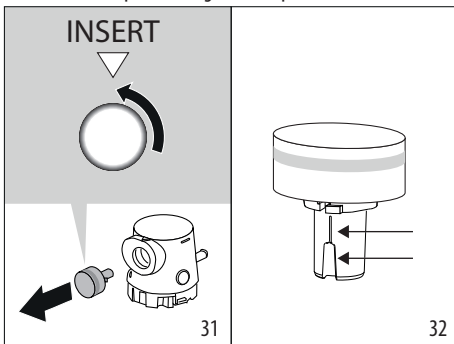

4. All components of the lid are dishwasher safe, placing them in the top basket. If you do not have a dishwasher, wash by hand as described in the note at the end of the section.

5. Make sure there are no milk residues on the hollow and groove under the dial (fig. 32); if necessary, scrape the groove with a toothpick;
6. Rinse inside the froth adjustment dial seat with running water (fig. 33);
7. Check that the intake tube and spout are not clogged with milk residues;
8. Reassemble all the lid components;
9. Carefully wash and rinse the milk container (D8);
10. Attach the lid back on the milk container.

Please note: washing by hand

Washing the lid in a dishwasher guarantees the perfect hygiene of all the components. When washing by hand, wash all components of the milk container lid thoroughly with hot water and immerse them in a basin of hot water for 30 minutes before proceeding as described in point (5).

5.12 Cleaning the steam nozzle

1. After every use, remove with a soft damp cloth any milk residues from the steam wand and the nozzle.
2. Use the steam for a deeper cleaning.
3. To maintain the better usability of the nozzle, use the Cleaning Tool (C15) for opening the hole (fig. 34).

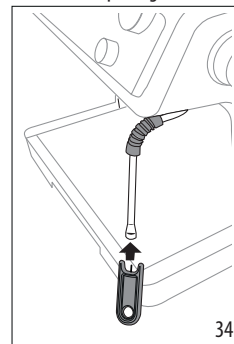

5.13 Other cleaning operations

1. Do not use solvents or abrasive detergents to clean the coffee maker. Use a soft damp cloth only;
2. Clean the portafilter;
3. You are recommended to use De'Longhi specific detergent for milk proteins and fat (Eco MultiClean).

6. WATER HARDNESS





6.1 Water hardness

The  descale light (B8) comes on after a period of time established according to water hardness. The machine can also be programmed according to the actual hardness of the water supply in the various regions, in which case descaling may be required less frequently.

Proceed as follows:

1. Remove the "TOTAL HARDNESS TEST" indicator paper (C6) from its pack.
2. Immerse the paper completely in a glass of water for one second.

3. Remove the paper from the water and shake lightly. After about a minute, 1, 2, 3, or 4 red squares form, depending on the hardness of the water. Each square corresponds to one level.

Total Hardness Test result	Button	Level
	x 2	1 soft water
		2 medium water
	OK	3 hard or very hard water
		

4. Set the appliance as indicated in section "3. Menu settings".

7. USING THE SOFTBALLS

Softballs is an innovative system that extends the life of the machine, without altering the sensory properties of the water, guaranteeing consistently creamy and aromatic coffee. For best results, add the Soft Balls in the water for a night before use.

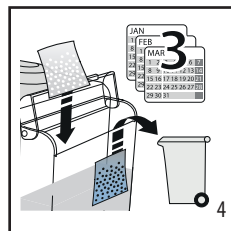
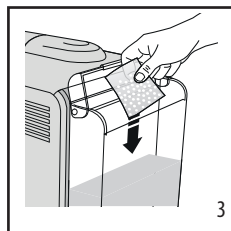
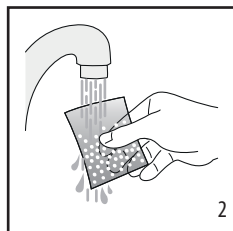
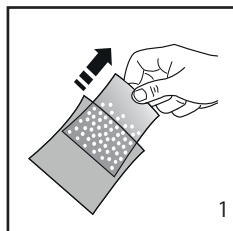

1. Extract the Softballs bag from the packaging.
2. Rinse with tap water the Softballs bag.
3. Deep the bag into the water tank.
4. Change the Softballs every 3 months.

8. DESCALING



EcoDecalk
mini
100 ml e / 3,40 fl.oz.

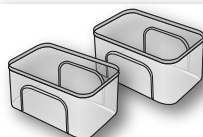

2L

Please note

- Before use, read the instructions and the labelling on the descaler pack.
- It is important to use De'Longhi descaler only. Using unsuitable descaler and/or performing descaling incorrectly may result in faults not covered by the manufacturer's guarantee.
- Descaler could damage delicate surfaces. If the product is accidentally spilt, dry immediately.

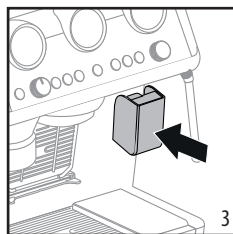
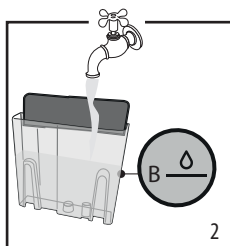
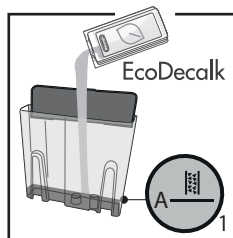
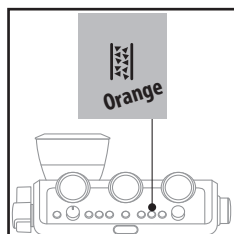

Descalc the appliance when the  light (B8) comes on (orange).

Please note

- If you want anticipate the cleaning cycle, press the descaling button (fig. 5) for 3 seconds.
- In case you start the descaling cycle by mistake, you can press the descaling button (fig. 5) for 10 seconds; the rinsing cycle can not be stopped (from step 9).

1. (IF PRESENT, REMOVE THE WATER SOFTENER DEVICE). Pour the descaler into the tank up to the level  A marked inside the tank (equal to one 100ml packet).

2. Add water (1 liter) up to the level  B. Then put the water tank back in the appliance.

3. Insert the dedicated accessory (C8) to the Latte Crema connection (A6).

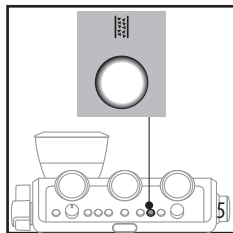
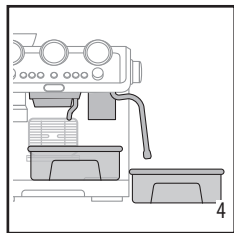

4. Make sure the portafilter is not attached and position a container under the coffee outlet, hot water spout and the other container under the steam wand.
5. Keep pressed the  button until the corresponding light begins to blink: descaling starts.

6. The descale programme starts and the descaler liquid comes out of the steam wand and coffee outlet. The descale programme removes limescale deposits from inside the appliance by automatically performing a series of rinses and pauses until the tank is empty. Delivery stops and the  light turns to white. This indicates that it is necessary to proceed with rinsing; see next page.



DESCALING

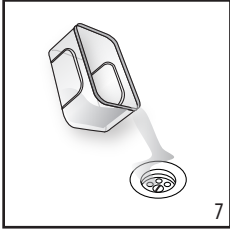

7. Empty the containers used to collect the descaler solution and replace them empty.

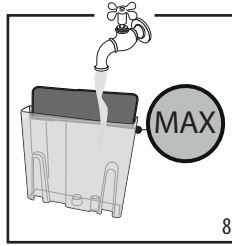

8. Remove the water tank, empty any residues of descaler solution, rinse with running water and fill with fresh water up to the MAX level. Put the tank back in its housing.

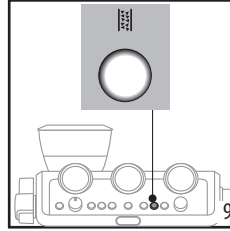

9. Keep pressed the  button until the corresponding light begins to blink: rinsing starts.

10. When rinsing is complete, delivery stops and the appliance prepares to be used again.
11. Empty the containers used to collect the rinse water.

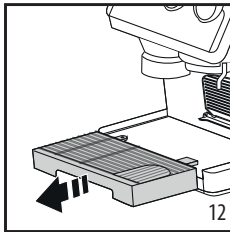



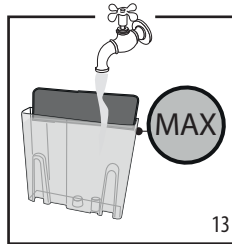

12. Extract and empty the drip tray, then put back in the appliance.



13. Empty, rinse, then fill the water tank with fresh water and replace it.

Now the appliance is ready to use.

9. TROUBLESHOOTING

PROBLEM	CAUSE	SOLUTION
There is water in the drip tray	It is normal: due to the internal water circuits operations	Regularly empty and clean the drip tray
No espresso coffee is delivered	No water in the tank (A15)	Fill the tank
	The  light is on to indicate that the coffee or steam circuit is empty	Press the button corresponding to the  light to fill the circuit
	The coffee filter is blocked	Clean as described in section "5.3 Coffee filter cleaning and maintenance" and "5.4 Cleaning the" Espresso Cool" filters"
	The tank has been inserted incorrectly and the valves on the bottom are not open	Press the tank down lightly to open the valves on the bottom
	Scale in the water circuit	Descale as described in section "8. Descaling"
	Coffee grind too fine	Adjust coffee dose and grinding (refer to Quick Guide)
The portafilter cannot be attached to the appliance	The ground coffee has not been pressed or is too much	Repeat grinding with new settings. Reduce the powder quantity; check if the filter (single or double filter) is the same size as the selector of grinding quantity (2x button (B3) selected or not)
The espresso coffee drips from the edges of the portafilter rather than the holes	The portafilter is inserted incorrectly	Attach the portafilter correctly and rotate firmly as far as it will go
	The espresso boiler gasket has lost elasticity or is dirty	Have the espresso boiler gasket replaced by Customer Services
	The coffee filter is clogged	Clean as described in section "5.3 Coffee filter cleaning and maintenance" and "5.4 Cleaning the" Espresso Cool" filters"
The coffee crema is too light (delivered from the spout too fast)	The appliance settings need reviewing	Refer to coffee guide for suggestions
The coffee crema is too dark (delivered from the spout too slowly)	The appliance settings need reviewing	Refer to coffee guide for suggestions
No milk froth is formed when making cappuccino with LatteCrema System	Milk not cold enough	Always use milk at refrigerator temperature
	The froth selection knob (D5) is not in the correct position	Check and turn to the right position the froth selection knob ( max froth;  med froth;  min froth)
	The LatteCrema System is dirty	Clean the cappuccino maker as described in section "5.11 Cleaning the LatteCrema System"
	Scale in the water circuit	Descale as described in section "8. Descaling"
...→		

PROBLEM	CAUSE	SOLUTION
At the end of descaling, the appliance requests a further rinse	During the rinse cycle, the water tank has not been filled to the MAX level	Complete the rinse cycle from point (8) of section "8. Descaling"
The appliance does not grind the coffee	There is foreign matter that cannot be ground in the coffee grinder	Clean the burrs as described in section "5.8 Cleaning the burrs", making sure you remove all the beans from the beans container (A1) before extracting it. Before putting the burr back, vacuum all residues from the housing (fig.14)
	The coffee beans container is not in the right position	The container is correctly inserted when the arrow ▲ is lined up with the  symbol and you hear a "click".
If you want to change the type of coffee	You must remove all the beans present in the machine	<ul style="list-style-type: none"> • Empty the beans container (if necessary, operate the coffee grinder without beans or use a vacuum cleaner to remove any remaining beans) • Attach the filter holder and operate the coffee grinder a number of times without beans to free the grinder. Attach the filter holder to the outlet of the grinder (A18), lining it up with "INSERT", then turning it to the right. Grinding begins when the filter holder reaches the CLOSE position and stops automatically. Repeat until the filter is empty • Place the new coffee in the beans container • If the amount of coffee ground is not enough to reach the perfect dose, proceed setting the appliance as for the first use
...→		

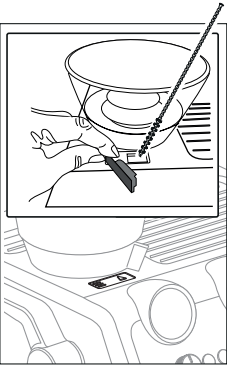
PROBLEM	CAUSE	SOLUTION
<p>After grinding, the coffee filter is empty</p> <p>After tamping, there is too much coffee in the filter</p>	<p>The coffee grinder coffee funnel is clogged</p>	<p>Clean as described in section "5.10 Cleaning the "Smart tamping station"". If the problem persists, access the guide by opening the hatch and free it using the brush)</p> 
<p>After grinding, the ground coffee in the filter does not reach the "perfect dose"</p>	<p>The "Smart Tamping Station" needs cleaning</p> <p>The quantity of ground coffee needs adjusting</p> <p>Over time the burrs wear down</p>	<p>Clean as described in section "5.10 Cleaning the "Smart tamping station"", then grind again</p> <p>Adjust the quantity of coffee with the dial (B2). If the dial is already in the max. position, proceed as described in section "Extra grinding adjustment"</p> <p>Replace the burrs as described in section "5.9 Replacing the burrs"</p>