

ETAM29.51X

BEAN TO CUP ESPRESSO
AND CAPPUCCINO
MACHINE
Instruction for Use

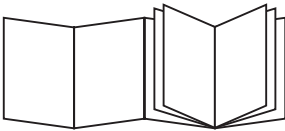

DeLonghi



B

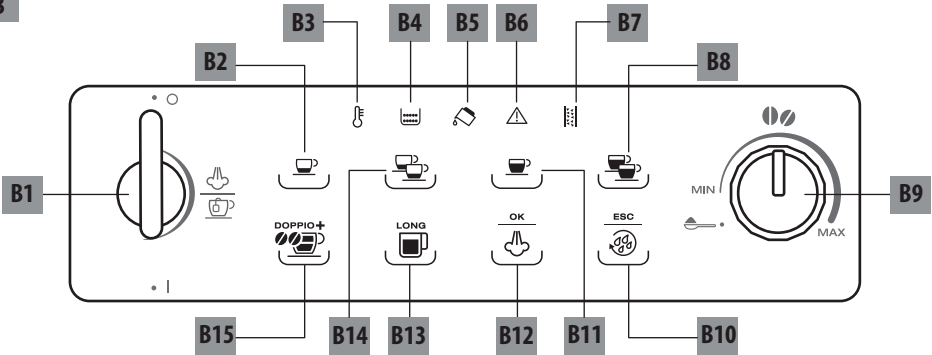

C

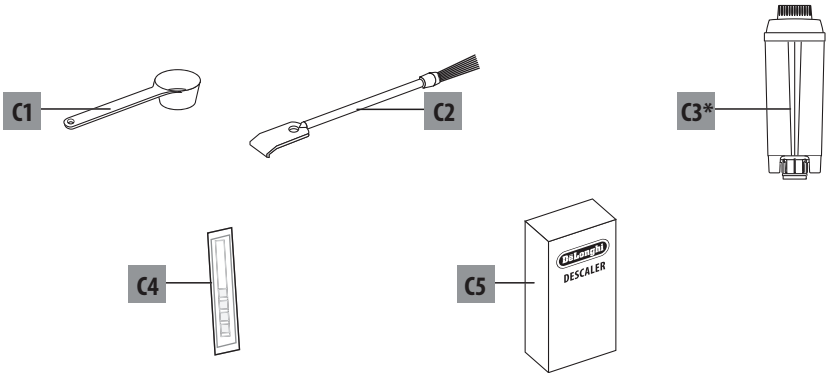

A

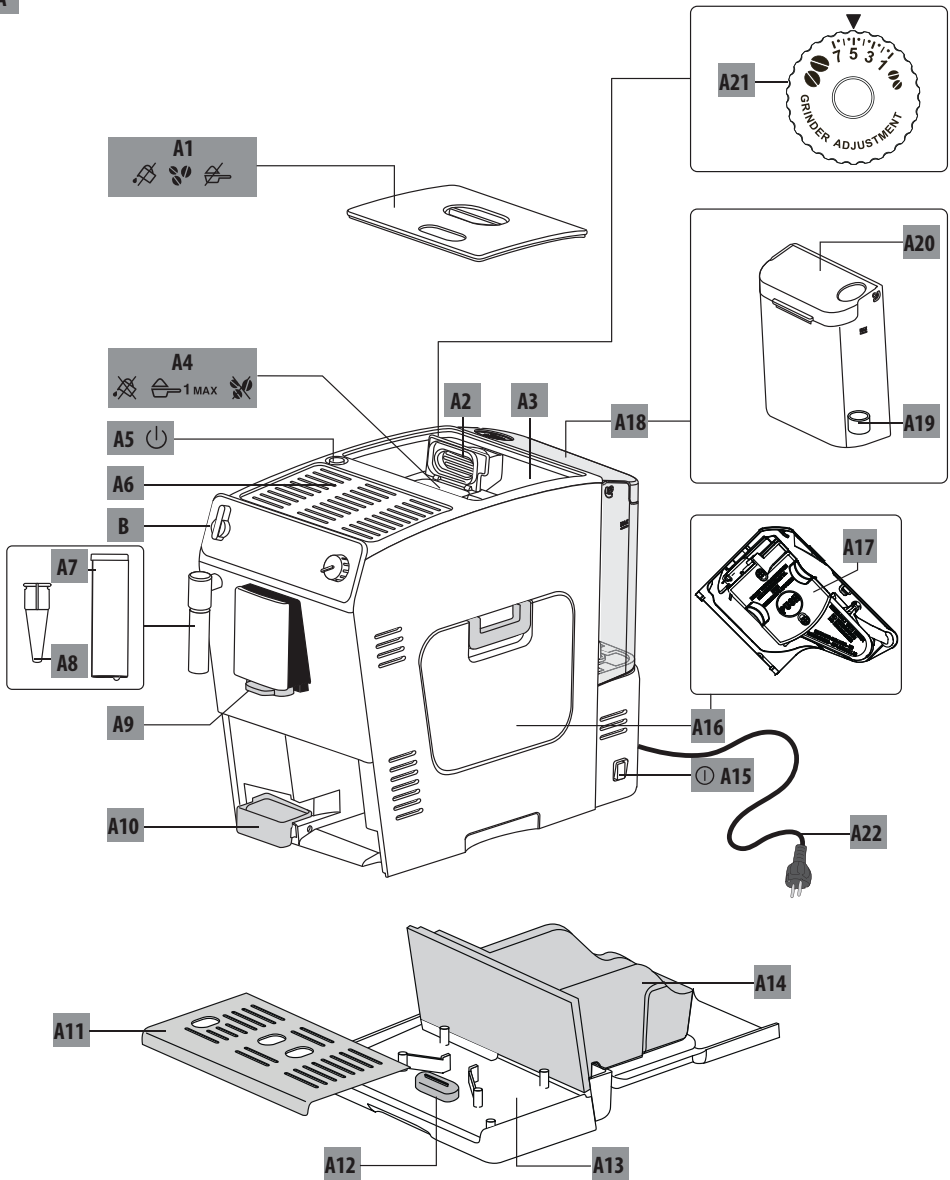

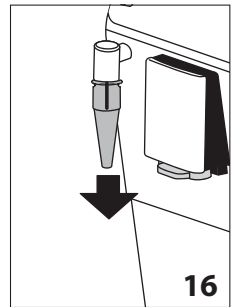
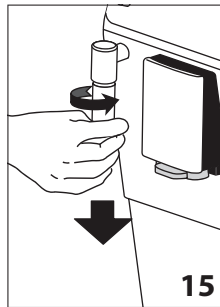
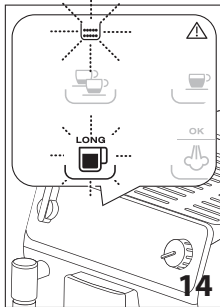
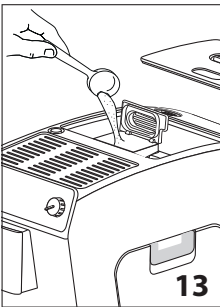
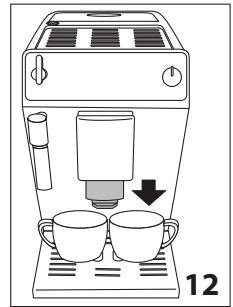
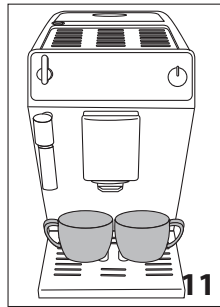
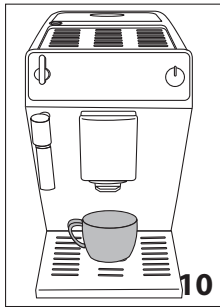
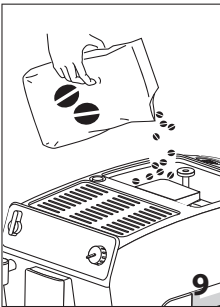
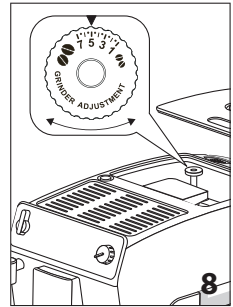
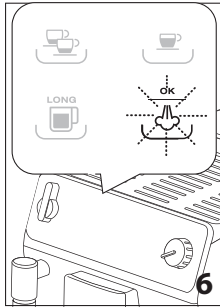
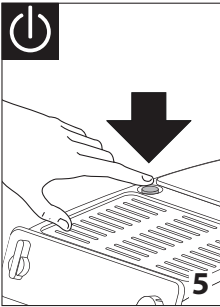
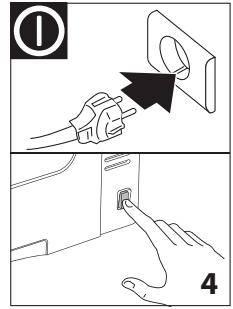
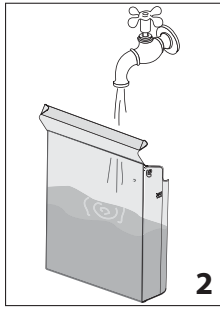
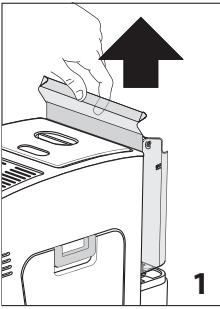

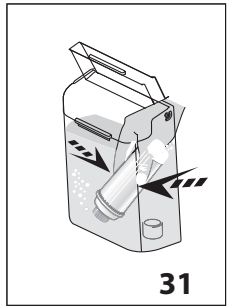
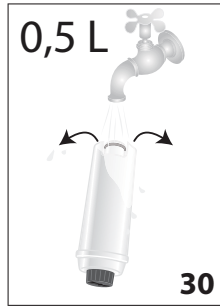
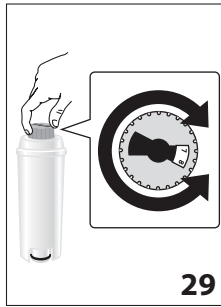
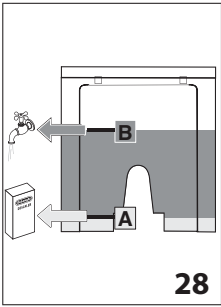
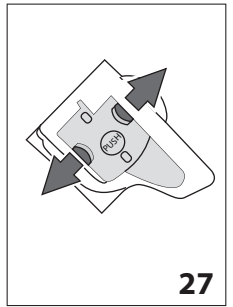
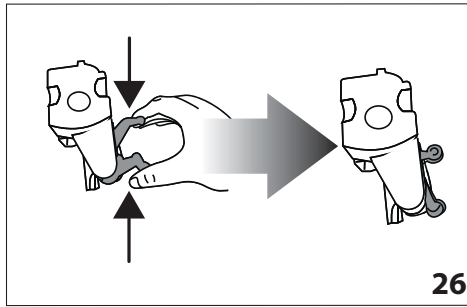
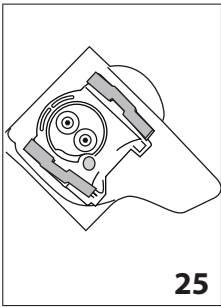
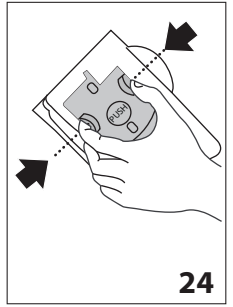
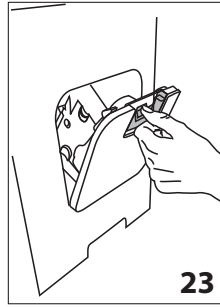
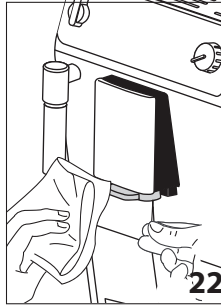
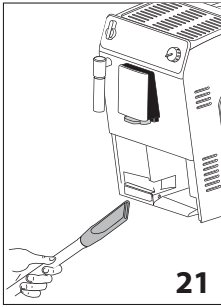
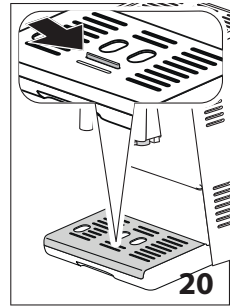
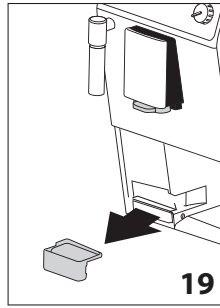
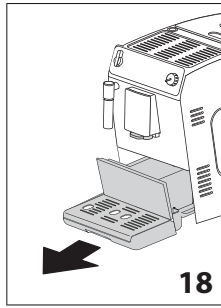
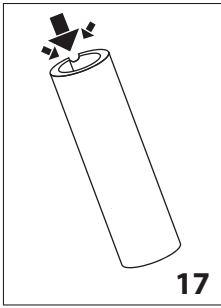

CONTENTS

FUNDAMENTAL SAFETY WARNINGS	7
IMPORTANT SAFEGUARDS	8
Symbols used in these instructions	8
Designated use	8
Instruction for Use.....	8
INTRODUCTION	8
Letters in brackets	8
Troubleshooting and repairs	8
DESCRIPTION	8
Description of the appliance	8
Description of the touch screen	9
Description of the accessories	9
BEFORE USE	9
Checking the appliance	9
Installing the appliance	9
Connecting the appliance	9
Setting up the appliance	9
TURNING THE APPLIANCE ON	10
TURNING THE APPLIANCE OFF	10
SETTING WATER HARDNESS	10
SETTING TEMPERATURE	10
AUTO-OFF	10
ENERGY SAVING	11
DEFAULT VALUES (RESET)	11
MAKING COFFEE	11
Selecting the coffee taste.....	11
Selecting the quantity of coffee in the cup	11
Adjusting the coffee mill	11
Tips for a hotter coffee	12
Making coffee using coffee beans	12
Making coffee using pre-ground coffee	12
Making DOUBLE+ coffee using coffee beans.....	12
Customising the DOUBLE+ coffee quantity	12
Making LONG coffee using coffee beans	13
Making LONG coffee using pre-ground coffee	13
Customising the “LONG coffee” quantity	13
MAKING CAPPUCCINO	13
Cleaning the cappuccino maker after use.....	13
DELIVERING HOT WATER	14
CLEANING	14
Cleaning the machine	14
Cleaning the coffee grounds container.....	14
Cleaning the drip tray and condensate tray.....	14
Cleaning the inside of the coffee machine	14
Cleaning the water tank.....	15
Cleaning the coffee spouts.....	15
Cleaning the pre-ground coffee funnel	15
Cleaning the infuser.....	15
DESCALING	15
SETTING WATER HARDNESS	16
Measuring water hardness.....	16
Setting water hardness	16
WATER SOFTENER FILTER (*CERTAIN MODELS ONLY)	16
Installing the filter	16
Replacing the filter	17
TECHNICAL DATA	17
EXPLANATION OF LIGHTS	17
DISPOSAL	18
TROUBLESHOOTING	19
ELECTRICAL CONNECTION (UK ONLY)	20

FUNDAMENTAL SAFETY WARNINGS

- Appliances can be used by persons with reduced physical, sensory or mental capabilities or lack of experience and knowledge if they have been given supervision or instruction concerning use of the appliance in a safe way and understand the hazards involved.
- Children shall not play with the appliance.
- Never clean by immersing the appliance in water.
- This is an household appliance only. It is not intended to be used in: staff kitchen areas in shops, offices and other working environments; farm houses; by clients in hotels, motels and other residential type environments; bed and breakfast type environments.
- If the plug or cord is damaged, it must be replaced by Customer Services only to avoid all risk.

FOR EUROPEAN MARKETS ONLY:

- Always unplug the appliance when left unattended and before assembly, taking apart or cleaning.
- This appliance shall not be used by children. Keep the appliance and its cord out of reach of children.
- Appliances can be used by persons with reduced physical, sensory or mental capabilities or lack of experience and knowledge if they have been given supervision or instruction concerning use of the appliance in a safe way and if they understand the hazards involved.
- Children shall not play with the appliance.



Surfaces marked with this symbol become hot during use (the symbol is present in certain models only).

IMPORTANT SAFEGUARDS

Symbols used in these instructions

Important warnings are identified by these symbols. It is vital to respect these warnings.



Failure to observe the warning may result in life threatening injury by electric shock.



Failure to observe the warning could result in injury or damage to the appliance.



Failure to observe the warning could result in scalds or burns.



This symbol identifies important advice or information for the user.



This is an electrical appliance and may cause electric shock.

You should therefore follow these safety warnings:

- Never touch the appliance with damp hands or feet.
- Never touch the plug with damp hands.
- Make sure the socket used is freely accessible at all times, enabling the appliance to be unplugged when necessary.
- Unplug directly from the plug only. Never pull the cord as you could damage it.
- To disconnect the appliance completely you must unplug it from the mains socket.
- If the appliance is faulty, do not attempt to repair. Turn it off, unplug from the mains socket and contact Customer Services.
- Before cleaning the appliance, turn it off, unplug from the mains socket and allow to cool.



Keep all packaging (plastic bags, polystyrene foam) away from children.



This appliance produces hot water and steam may form while it is in operation.

Avoid contact with splashes of water or hot steam.

When the appliance is in operation, the cup shelf (A6) could become very hot.

Designated use

This appliance is designed and made to prepare coffee and heat drinks. Any other use is considered improper and thus dangerous. The manufacturer is not liable for damage deriving from improper use of the appliance.

Instruction for Use

Read this Instruction for Use carefully before using the appliance. Failure to follow this Instruction for Use may result in burns or damage to the appliance.

The manufacturer is not liable for damage deriving from failure to respect this Instruction for Use.



Keep this Instruction for Use. If the appliance is passed to other persons, they must also be provided with this Instruction for Use.

INTRODUCTION

Thank you for choosing this bean to cup espresso and cappuccino machine.

We hope you enjoy using your new appliance. Take a few minutes to read this Instruction for Use. This will avoid all risks and damage to the appliance.

Letters in brackets

The letters in brackets refer to the legend in the description of the appliance on page 2-3.

Troubleshooting and repairs

In the event of problems, first try and resolve them following the information given in the sections "Meaning of alarm lights" on page 18 and "Troubleshooting" on page 20.

If this does not resolve the problem or you require further information, you should consult Customer Services by calling the number given on the annexed "Customer Services" sheet.

If your country is not among those listed on the sheet, call the number given in the guarantee. If repairs are required, contact De'Longhi Customer Services only. The addresses are given in the guarantee certificate provided with the machine.

DESCRIPTION

Description of the appliance

(page 3 - A)















- A1. Beans container lid
- A2. Pre-ground coffee funnel lid
- A3. Beans container
- A4. Pre-ground coffee funnel
- A5.  button: turns the appliance on and off (standby)
- A6. Cup shelf
- A7. Cappuccino maker (removable)
- A8. Hot water and steam connection nozzle (removable)
- A9. Coffee spout (adjustable height)
- A10. Condensate tray
- A11. Cup tray
- A12. Drip tray water level indicator

- A13. Drip tray
- A14. Coffee grounds container
- A15. Main switch (ON/OFF)
- A16. Infuser door
- A17. Infuser
- A18. Water tank
- A19. Water softener filter housing
- A20. Water tank lid
- A21. Grinding adjustment dial
- A22. Power cord

Description of the touch screen

(page 2 - B)

A number of icons on the touch screen have a double function. This is indicated in brackets in the description.

- B1. Steam/hot water dial 
- B2.  icon: to make 1 cup of short espresso coffee
- B3.  flashing light: the appliance is heating up
- B4.  light:
 - on steadily: put the grounds container back (A15)
 - flashing: the grounds container needs emptying
- B5.  light: fill the water tank (A18)
- B6.  light: general alarm
- B7.  light flashing: the appliance needs descaling
- B8.  icon: makes 2 cups of long espresso coffee
- B9.  Coffee taste selection dial
- B10.  icon: performs a rinse cycle (when in the settings menu: press to exit the current programming)
- B11.  icon: makes 1 cup of long espresso coffee
- B12.  icon:
 - on steadily: turns the steam function on (when in the settings menu: press to confirm the current programming)
 - flashing: the steam/hot water dial must be turned (B1)
- B13.  icon: makes one cup of LONG coffee (when in the settings menu: press to scroll through the various selections/settings)
- B14.  icon: to make 2 cups of short espresso coffee
- B15.  icon: to make one DOPPIO+ coffee

Description of the accessories

(page 2 - C)

- C1. Pre-ground coffee measure
- C2. Cleaning brush
- C3. Water softener filter (*certain models only)
- C4. "Total Hardness Test" indicator paper
- C5. Descaler

BEFORE USE

Checking the appliance

After removing the packaging, make sure the product is complete and undamaged and that all accessories are present. Do not use the appliance if it is visibly damaged. Contact De'Longhi Customer Services.

Installing the appliance

Important!

When you install the appliance, you should respect the following safety warnings:

- The appliance gives off heat. After positioning the appliance on the worktop, leave a space of at least 3 cm between the surfaces of the appliance and the side and rear walls and at least 15 cm above the appliance.
- Water penetrating the coffee machine could cause damage. Do not place the appliance near taps or sinks.
- The appliance could be damaged if the water it contains freezes. Do not install the appliance in a room where the temperature could drop below freezing point.
- Arrange the cord in such a way that it cannot be damaged by sharp edges or contact with hot surfaces (e.g. electric hot plates).

Connecting the appliance

Important!

Check that the mains power supply voltage corresponds to the value indicated on the rating plate on the bottom of the appliance.

Connect the appliance to an efficiently earthed and correctly installed socket with a minimum current rating of 10A only.

If the power socket does not match the plug on the appliance, have the socket replaced with a suitable type by a qualified professional.



Setting up the appliance

Please note :

- Coffee has been used to factory test the appliance and it is therefore completely normal for there to be traces of coffee in the mill. The machine is, however, guaranteed to be new.
- You should customise water hardness as soon as possible following the instructions in the section "Setting water hardness" on page 17.

Proceed as described:

1. Remove the water tank (fig. 1), fill to the MAX line with fresh water (fig. 2) then put back in the appliance.

- Place a container with a minimum capacity of 100 ml under the cappuccino maker (fig. 3).
- Plug the appliance into the mains socket and press the main switch on the side of the appliance (fig. 4).
- Press the  button (A5) (fig. 5).
- The  light flashes on the touch screen (fig. 6).
- Turn the steam dial to the "I" position (fig. 7). Water is delivered from the cappuccino maker.
- When delivery stops automatically, turn the steam dial back to the "0" position.

The appliance goes off.

To reuse it, press the  button (A5) again.

 **Please note :**

- The first time you use the appliance, you need to make 4-5 cups of coffee before the appliance starts to give satisfactory results.



TURNING THE APPLIANCE ON

 **Please note!**

- Before turning the appliance on, make sure the main switch is pressed (fig. 4).
- Each time the appliance is turned on, it performs an automatic preheat and rinse cycle which cannot be interrupted. The appliance is ready for use only after completion of this cycle.

 **Danger of burns!**

During rinsing, a little hot water comes out of the coffee spouts and is collected in the drip tray underneath. Avoid contact with splashes of water.

- To turn the appliance on, press the  button (fig. 5). The  light (B3) flashes while the appliance is heating up and performing an automatic rinse cycle. By circulating hot water, the appliance heats both the boiler and the internal circuits.



The appliance is at temperature when the  light goes off and the coffee lights come on.

TURNING THE APPLIANCE OFF

Whenever the coffee machine is turned off after being used to make coffee, it performs an automatic rinse cycle.

 **Danger of burns!**

During rinsing, a little hot water flows from the coffee spouts. Avoid contact with splashes of water.

- To turn the appliance off, press the  button (fig. 5).
- The  light (B3) flashes to indicate the appliance is going off.

 **Please note!**

If you will not be using the appliance for some time, unplug from the mains socket:

- first turn the appliance off by pressing the  button (fig. 5);
- press the main switch on the side of the appliance (fig. 4).

 **Important!**



Never press the main switch while the appliance is on.











SETTING WATER HARDNESS



For instructions on setting water hardness, see page 16.

SETTING TEMPERATURE

If you want to modify the temperature of the water used to make the coffee (low, medium, high, maximum), proceed as follows:

- With the appliance off (standby), but the main switch pressed (fig. 4);
- press and hold the  icon (B2) until the lights and icons on the touch screen (B) come on;
- press the  icon (B13) to select the required temperature:

	low
 	medium
  	high
   	maximum



- Press the  icon (B12) to confirm (or  (B10) to exit without making the modification). The lights/icons go off.







The temperature is now programmed.

AUTO-OFF



The time can be changed so that the appliance switches off after being idle for 15 or 30 minutes, or after 1, 2 or 3 hours.

To reprogramme auto-off, proceed as follows:

- With the appliance off (standby), but the main switch pressed (fig. 4);
- press and hold the  icon (B8) until the lights and icons on the touch screen (B) come on;
- press the  icon (B13) to select the required time:

	15 min.
 	30 min.
  	1 hour







   	2 hours
    	3 hours

- press the  icon (B12) to confirm (or  (B10) to exit without making the modification). The lights/icons go off.

The auto-off time is now programmed.

ENERGY SAVING

Use this function to enable or disable energy saving. This mode is active by default, reducing energy consumption while the machine is on in compliance with current European regulations. To change the setting, proceed as follows:

- With the appliance off (standby), but the main switch pressed (fig. 4);
- press and hold the  icon (B13) until the icons and the  light (B3) (if energy saving is enabled) come on;
- press again the  icon to enable (the  (B3) comes on) or disable (the  (B3) goes off) energy saving;
- press the  icon (B12) to confirm (or  (B10) to exit without making the modification). The lights/icons go off.

The energy saving setting is now programmed.





Please note!

- When in energy saving mode, a few seconds may elapse before the first coffee is delivered as the appliance must heat up again.

DEFAULT VALUES (RESET)

This function resets all settings (temperature, auto-off, water hardness, energy saving and all quantity settings are reset to the default values).

- With the appliance off (standby), but the main switch pressed (fig. 4);
- press and hold the  icon (B15) until the icons on the touch screen (B) come on;
- press the  icon (B12) to reset the default values (or  (B10) to exit without making the modification). The icons go off.

The settings and quantities have been reset to the default values.

MAKING COFFEE

Selecting the coffee taste

Turn the coffee taste selection dial (B9) to set the required taste. Turning it clockwise increases the quantity of coffee beans the appliance will grind and therefore the strength of the coffee obtained. Turn the dial to MIN for an extra mild coffee and to MAX for an extra strong coffee.

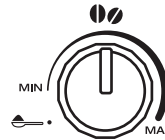





Please note:



- The first time you use the appliance, you will need to make a number of coffees to identify the correct dial position through trial and error.
- Do not turn the dial too far towards MAX, otherwise the coffee may be delivered too slowly (a drop at a time), particularly when making two cups of coffee at the same time.

Selecting the quantity of coffee in the cup

The appliance is set by default to automatically make the following quantities of coffee:

coffee requested	icon	quantity delivered
1 short coffee		(≈40ml)
1 long coffee		(≈120ml)
2 short coffees		(≈40ml) x2
2 long coffees		(≈120ml) x2

To change the quantity of coffee the appliance delivers automatically into the cup, proceed as described below:

- press and hold the  icon (B2) or  icon (B6) (depending on the quantity you want to modify) until the icon flashes and all the alarm lights flash 4 times. When the appliance starts delivering coffee, release the icon;
- when the coffee in the cup reaches the required level, press the same icon again to memorise the new amount.

When the icon is pressed again, the new quantities have been memorised.



Please note!

Programming the one coffee quantity also programmes the quantity of coffee in the corresponding two cups.

Adjusting the coffee mill

The coffee mill is set by default to prepare coffee correctly and should not require regulating initially.

However, if after making the first few coffees you find that the coffee is either too weak and not creamy enough or delivery is too slow (a drop at a time), this can be corrected by adjusting the grinding adjustment dial (fig. 8).



Please note!

The grinding adjustment dial must only be turned when the coffee mill is in operation.



If the coffee is delivered too slowly or not at all, turn one click clockwise towards “7”.

For fuller bodied creamier coffee, turn one click anticlockwise towards “1” (do not turn more than one click at a time otherwise the coffee could be delivered

a drop at a time). These adjustments will only be evident after at least 2 cups of coffee have been delivered. If this adjustment does not obtain the desired result, turn the dial another click.

Tips for a hotter coffee

For hotter coffee, you should:





- perform a **rinse** cycle before delivering the coffee by pressing the  icon (B10);
- warm the cups with hot water (using the hot water function);
- increase coffee temperature as described in the previous paragraph (page 10).

Making coffee using coffee beans



Do not use caramelised or candied coffee beans as they could stick to the coffee mill and make it unusable.

- Fill the container with coffee beans (fig. 9).
- Place under the coffee spouts:
 - 1 cup, if you want to make 1 coffee (fig. 10);
 - 2 cups, if you want 2 coffees (fig. 11).
- Lower the spouts as near as possible to the cup. This makes a creamier coffee (fig. 12).
- Press the icon corresponding to the required coffee:

coffee requested	icon
1 short coffee	
1 long coffee	
2 short coffees	
2 long coffees	

- Preparation begins and the light corresponding to the selected icon flashes on the touch screen.

Once the coffee has been made, the appliance is ready to make the next drink.



- While the machine is making coffee, delivery can be interrupted at any moment by pressing any icon.
- At the end of delivery, to increase the quantity of coffee in the cup, just press one of the coffee icons (within 3 seconds).

Once the coffee has been made, the appliance is ready to make the next drink.



- If the coffee is delivered a drop at a time, too weak and not creamy enough or too cold, read the tips in the “Troubleshooting” section (page 19).
- Lights may be displayed on the touch screen during use. Their meaning is given in the section “Explanation of the lights” on page 17.
- For hotter coffee, see the section “Tips for a hotter coffee” (page 12).



Making coffee using pre-ground coffee



- Never place coffee beans in the pre-ground coffee funnel as this could damage the appliance.
- Never add pre-ground coffee when the machine is off or it could spread through the inside of the machine and dirty it. This could damage the appliance.
- Never use more than 1 level measure or it could dirty the inside of the coffee machine or block the funnel.



When you use pre-ground coffee, you can only make one cup of coffee at a time.

- Make sure the appliance is on.
- Turn the dial  (B9) anticlockwise to the  position.
- Open the pre-ground coffee funnel lid.
- Make sure the funnel is not blocked, then add one level measure of pre-ground coffee (fig. 13).
- Place a cup under the coffee spouts (fig. 10).
- Press the 1 cup coffee icon , (B2).
- Preparation begins.





If “Energy Saving” mode is active, you may have to wait a few seconds before the first coffee is delivered.

Making DOUBLE+ coffee using coffee beans

Prepare the appliance following the instructions in the section “Making coffee using coffee beans”, then press the  icon (B15).

Customising the DOUBLE+ coffee quantity

The appliance is set by default to deliver about 120 ml of DOUBLE+ coffee. To modify these settings, proceed as follows:

1. Place a sufficiently large cup or glass under the coffee spouts.
2. Press and hold the  icon (B15) until the icon flashes and all the alarm lights flash 4 times;
3. Release the  icon. The appliance starts delivering coffee;
4. As soon as the coffee in the cup reaches the required level, press the  icon again.

The quantity of coffee in the cup has now been programmed.





 **Please note!**

You can programme a minimum quantity of about 80ml.
You can programme a maximum quantity of about 160ml.

Making LONG coffee using coffee beans



Prepare the appliance following the instructions in the section “Making coffee using coffee beans”, then press the  icon (B13).

Making LONG coffee using pre-ground coffee

1. Follow the instructions in points 1, 2, 3 and 4 of the section “Making coffee using pre-ground coffee”, then press the  icon (B13);
2. The appliance starts delivering coffee. Halfway through preparation, the  light comes on and the  light and  icon flash (fig. 14);
3. Place the pre-ground coffee in the funnel;
4. Press the  icon. Preparation resumes.

Customising the “LONG coffee” quantity

The appliance is set by default to automatically deliver about 200ml of LONG coffee. To modify these settings, proceed as follows:

1. Place a sufficiently large cup or glass under the coffee spouts.
2. Press and hold the  icon (B13) until the icon flashes and all the alarm lights flash 4 times;
3. Release the  icon. The appliance starts delivering coffee;
4. As soon as the coffee in the cup reaches the required level, press the  icon again.

The quantity of coffee in the cup has now been programmed.

MAKING CAPPUCCINO

 **Danger of burns!**







During preparation, steam is given off. Take care to avoid scalds.

1. When preparing cappuccino, make the coffee in a large cup;

2. Fill a container (preferably one with a handle to avoid scalding) with about 100 grams of milk for each cappuccino. In choosing the size of the container, bear in mind that the milk doubles or triples in volume;

 **Please note :**

For a richer denser froth, use skimmed or partially skimmed milk at refrigerator temperature (about 5°C). To avoid milk with poor froth or large bubbles, always clean the cappuccino maker as described in the section “Cleaning the cappuccino maker after use”.

3. The cappuccino maker can be turned slightly outwards to allow containers of any size to be used.
4. Immerse the cappuccino maker in the milk container. Never immerse the black ring;
5. Press the  icon (B12). The light  (B3) flashes to indicate the appliance is heating up;
6. When the appliance is at temperature, the  light goes off and the  icon flashes;
7. Turn the hot water/steam dial  (B1) to the I position. For a creamier froth, rotate the container with slow movements in an upward direction. (You should not deliver steam for more than 3 minutes at a time);
8. When you have obtained the required froth, stop steam delivery by turning the dial to the “0” position. The  icon flashes, *ok*;
9. Press the  icon to exit the steam function.

 **Danger of burns!**

Interrupt steam delivery before removing the container with the frothed milk to avoid burns caused by splashes of boiling milk.

10. Add the milk froth to the coffee prepared previously. The cappuccino is ready. Sweeten to taste and, if desired, sprinkle the froth with a little cocoa powder.

 **Please note!**

If “Energy saving” is active, you may have to wait a few seconds before steam is delivered.

Cleaning the cappuccino maker after use.

Clean the cappuccino maker each time you use it to avoid the build-up of milk residues or blockages.

 **Danger of burns!**

When cleaning the cappuccino maker, a little hot water is delivered. Avoid contact with splashes of water.

1. Deliver a little water by turning the hot water/steam dial  (B1) to the I position. Then stop delivery by turning the dial back to the 0 position.



2. Wait a few minutes for the cappuccino maker to cool down. Turn the cappuccino maker downwards to remove it (fig. 15).
3. Remove the nozzle downwards (fig. 16).
4. Make sure the two holes shown by the arrow in fig. 17 are not blocked. If necessary, clean with a pin.
5. Reinsert the nozzle and replace the cappuccino maker on the nozzle, pushing it upwards and turning it until it is attached.

DELIVERING HOT WATER



Important! Danger of burns.

Never leave the machine unattended while delivering hot water. The hot water spout becomes hot while water is being delivered and must be handled by the handle only.

1. Place a container under the cappuccino maker (as close as possible to avoid splashes).
2. Turn the hot water/steam dial  (B1) to the I position.
4. To stop hot water delivery manually, turn the hot water/steam dial  to the 0 position.



Please note!

If "Energy Saving" is active, you may have to wait a few seconds before hot water and steam are delivered.

CLEANING

Cleaning the machine

The following parts of the machine must be cleaned regularly:

- coffee grounds container (A14),
- drip tray (A13),
- water tank (A18),
- coffee spouts (A9),
- cappuccino maker (A8)
- pre-ground coffee funnel (A2),
- infuser (A17), accessible after opening the service door (A16),
- touch screen (B)



Important!

- Do not use solvents, abrasive detergents or alcohol to clean the coffee machine. With De'Longhi superautomatic coffee machines, you need not use chemical products to clean the machine.
- Do not use metal objects to remove encrustations or coffee deposits as they could scratch metal or plastic surfaces.

Cleaning the coffee grounds container

When the  light flashes on the display, the grounds container must be emptied and cleaned. The appliance cannot be used to make coffee until you have cleaned the grounds container. Even if not full, the empty grounds container message is displayed 72 hours after the first coffee has been prepared. For the 72 hours to be calculated correctly, the machine must never be turned off with the main switch.

To clean (with the machine on):

- Remove the drip tray (fig. 18), empty and clean.
- Empty the grounds container (A14) and clean thoroughly to remove all residues left on the bottom. This can be done using the spatula on the brush (C2) provided.
- Check the condensate tray (A10) and empty if necessary (fig. 19).



Important!

When removing the drip tray, the grounds container must be emptied, even if it contains few grounds. If this is not done, when you make the next coffees, the grounds container may fill up more than expected and clog the machine.

Cleaning the drip tray and condensate tray



Important!

The drip tray (A13) is fitted with a level indicator (red) (A12) showing the level of water it contains (fig. 20). Before the indicator protrudes from the cup tray, the drip tray must be emptied and cleaned, otherwise the water may overflow the edge and damage the appliance, the surface it rests on or the surrounding area.

To remove the drip tray:

1. Remove the drip tray and the grounds container (fig. 18);
2. Empty the drip tray and grounds container (A14) and wash them;
3. Check the condensate tray (A10) and empty if necessary.
4. Replace the drip tray and grounds container.

Cleaning the inside of the coffee machine



Danger of electric shock!

Before cleaning internal parts, the machine must be turned off (see "Turning off") and unplugged from the mains power supply. Never immerse the coffee machine in water.

1. Check regularly (about once a week) that the inside of the appliance (accessible after removing the drip tray (A13)) is not dirty. If necessary, remove coffee deposits with the brush (C2) supplied and a sponge.
2. Remove the residues with a vacuum cleaner (fig. 21).

Cleaning the water tank

1. Clean the water tank (A18) regularly (about once a month and whenever you replace the water softener filter (C3) (if provided) with a damp cloth and a little mild washing up liquid.
2. Remove the filter (if present) and rinse with running water.
3. Replace the filter (if provided), fill the tank with fresh water and replace the tank.
4. (Models with water softener filter only) Deliver about 100ml of hot water to reactivate the filter.

Cleaning the coffee spouts

1. Clean the coffee spouts regularly with a sponge or cloth (fig. 22).
2. Check the holes in the coffee spouts are not blocked. If necessary, remove coffee deposits with a toothpick (fig. 22).

Cleaning the pre-ground coffee funnel

Check regularly (about once a month) that the pre-ground coffee funnel (A4) is not blocked. If necessary, remove coffee deposits with the brush (C2) supplied.

Cleaning the infuser

The infuser (A17) must be cleaned at least once a month.



Important!

The infuser may not be extracted when the machine is on.

1. Make sure the machine is correctly turned off (see "Turning off", page 10).
2. Open the infuser door (fig. 23) on the right side of the appliance.
3. Press the two red release buttons inwards and at the same time pull the infuser outwards (fig. 24).
4. Soak the infuser in water for about 5 minutes, then rinse under the tap.



Important!

RINSE WITH WATER ONLY

NO WASHING UP LIQUID - NO DISH WASHER

Clean the infuser without using washing up liquid as it could be damaged.

5. Use the brush (C2) to remove any coffee residues left in the infuser housing, visible through the infuser door.
6. After cleaning, replace the infuser by sliding it onto the internal support (fig. 25), then push the PUSH symbol fully in until it clicks into place.



Please note!

If the infuser is difficult to insert, before insertion, adapt it to the right size by pressing the two levers shown in fig. 26.

7. Once inserted, make sure the two red buttons have snapped out (fig. 27).
8. Close the infuser door.

DESCALING

Descal the appliance when the light (B7) flashes.



Important!

- Descaler contains acids which may irritate the skin and eyes. It is vital to respect the manufacturer's safety warnings given on the descaler pack and the warnings relating to the procedure to follow in the event of contact with the skin and eyes.
- You should use De'Longhi descaler only. Using unsuitable descaler and/or performing descaling incorrectly may result in faults not covered by the manufacturer's guarantee.

1. With the appliance off (standby), but the main switch pressed (fig. 4);
2. Press and hold the icon (B11) until the light (B7) comes on.
3. Empty the water tank (A18) completely and remove the water softener filter (if present). Empty the drip tray (fig. 18) and grounds container, then put them back in the appliance.
4. Pour the descaler into the tank up to level **A** (corresponding to a 100 ml pack) marked on the back of the tank (fig. 28), then add water (1 litre) up to level **B** (fig. 28) and put the water tank back.
5. Place an empty container with a minimum capacity of 2 litres under the hot water spout (fig. 3).









Important! Danger of burns

Hot water containing acid flows out of the hot water spout. Avoid contact with splashes of water.

6. Press the icon (B12) to confirm that you have added the solution.
7. The icon flashes to indicate the hot water/steam dial (B1) must be turned to the I position. As soon as the dial has been turned, the descale programme starts and the descaler liquid comes out of the water spout.
8. The descale programme automatically performs a series of rinses and pauses to remove limescale deposits from inside the machine.

After about 30 minutes, descaling stops: the icon flashes. Turn the hot water/steam dial to the 0 position: and icons flashes on the touch screen. .

9. The appliance is now ready for rinsing through with clean water. Extract the water tank (A18), empty, rinse under running water, fill with clean water up to the MAX level, insert the filter (if removed previously) and put the water tank back in the machine.

- Empty the container used to collect the descaler solution and replace it empty under the hot water spout.
- Turn the hot water/steam dial  back to the I position to start rinsing. Hot water comes out of the spout.
- When the water tank is completely empty, the  icon flashes. Turn the hot water/steam dial  to the 0 position:  light flashes on the touch screen.
- Extract the water tank and fill with fresh water up to the MAX level;
- Empty the container used to collect the descaler solution and replace it empty under the hot water spout;
- Turn the hot water/steam dial  to the I position.
- The appliance begins rinsing again and ends with water being delivered from the coffee spout (A9) ( **Danger of burns!**)
- The  light flashes : turn the hot water/steam dial to the 0 position and top up the tank with fresh water to the MAX level.

Descaling is complete.

SETTING WATER HARDNESS

The  light comes on after a period of time established according to water hardness.

The machine is set by default for a hardness value of 4. The machine can also be programmed according to the hardness of the mains water in the various regions so that the machine needs to be descaled less often.



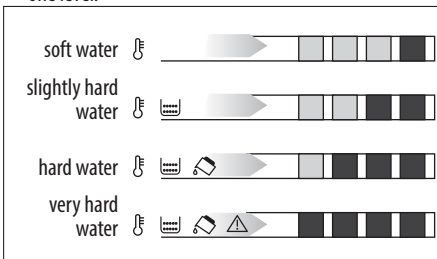

Measuring water hardness

- Remove the "TOTAL HARDNESS TEST" indicator paper from its pack (attached to the English instructions).
- Immerse the paper completely in a glass of water for one second.
- Remove the paper from the water and shake lightly. After about a minute, 1, 2, 3, or 4 red squares form, depending on the hardness of the water. Each square corresponds to one level.



Setting water hardness

- With the appliance off (standby), but the main switch pressed (fig. 4);

- Press the  icon (B14) until the icon lights up, together with the lights indicating the current setting;
- Press the  icon (B13) to select the hardness identified with the indicator paper;
- Press the  icon (B12) to confirm (or  (B10) to exit without making the modification).

The machine is now reprogrammed with the new water hardness setting.

WATER SOFTENER FILTER (*CERTAIN MODELS ONLY)

Certain models are fitted with a water softener filter. If this is not the case with your model, you are recommended to purchase one from De'Longhi Customer Services.

To use the filter correctly, follow the instructions below.

Installing the filter

- Remove the filter (C3) from the packaging.
- Turn the date indicator disk (see fig. 29) until the next two months of use are displayed.



Please note

The filter lasts about two months if the appliance is used normally. If the coffee machine is left unused with the filter installed, it will last a maximum of three weeks.

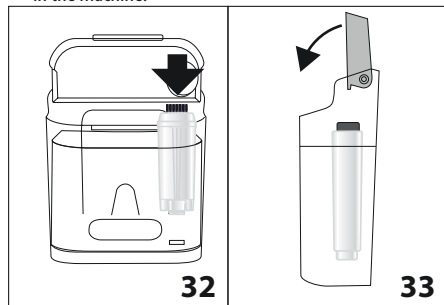
- To activate the filter, run tap water through the hole in the filter as shown in the figure until water comes out of the openings at the side for more than a minute (fig. 30).
- Extract the tank (A18) from the appliance and fill with water.
- Insert the filter in the water tank and immerse it completely for about ten seconds, sloping it and pressing it lightly to enable the air bubbles to escape (fig. 31).
- Insert the filter in the filter housing (fig. 32) and press as far as it will go.
- Close the tank with the lid (fig. 33), then replace the tank in the machine.



- Position a container under the hot water spout (min. capacity: 500 ml).

9. Deliver hot water by turning the hot water/steam dial  (B1) to the I position.
12. Deliver at least 500 ml of hot water, then turn the hot water/steam dial  to the 0 position.

The filter is now active and you can use the coffee machine.

Replacing the filter

After two months (see date indicator) or when the appliance has not been used for 3 weeks, you should replace the filter:

1. Extract the tank (A15) and exhausted filter (C3);
2. Take the new filter out of its packet and proceed as illustrated in points 2 to 10 in the previous section.

The new filter is now active and you can use the coffee machine.

TECHNICAL DATA







Voltage:	220-240 V~ 50/60 Hz max. 10A
Absorbed power:	1450W
Pressure:	1,5MPa (15 bar)
Max. water tank capacity:	1,4 l
Size: LxDxH:	195x480x340 mm
Cord length:	1050 mm
Weight:	9,1 kg
Max. beans container capacity:	200 g











The appliance complies with the following EC directives:

- Low Voltage Directive 2006/95/EC and subsequent amendments;
- EMC Directive 2004/108/EC and subsequent amendments;
- European Standby Regulation 1275/2008
- Materials and accessories coming into contact with food conform to EEC regulation 1935/2004.

EXPLANATION OF LIGHTS

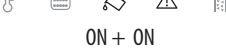
LIGHTS DISPLAYED	POSSIBLE CAUSE	SOLUTION
 FLASHING	Insufficient water in the tank (A18).	Fill the tank (A18) with water and/or insert it correctly, pushing it as far as it will go until it clicks into place.
 FLASHING	The grounds container (A14) is full.	Empty the grounds container and drip tray (A13), clean and replace (fig. 18). Important: when removing the drip tray, the grounds container MUST be emptied, even if it contains few grounds. If this is not done, when you make the next coffees, the grounds container may fill up more than expected and clog the machine.
 ON	After cleaning, the grounds container has not been replaced.	Remove the drip tray (A13) and insert the grounds container.
 ON + FLASHING	The coffee beans have run out.	Fill the beans container (fig. 9).
	The pre-ground coffee funnel is clogged.	Empty the funnel with the help of a brush as described in the section "Cleaning the pre-ground coffee funnel" (page 15).
 FLASHING + ON	The "pre-ground coffee" function has been selected without placing any pre-ground coffee in the funnel.	Place pre-ground coffee in the funnel or deselect the "pre-ground" function (fig. 13).
 FLASHING	The machine must be descaled.	The descaling procedure described in the section "Descaling" needs to be performed as soon as possible (page 16).

 <p>FLASH. + ON + FLASH.</p>	<p>The grinding is too fine and the coffee is delivered too slowly or not at all.</p>	<p>Repeat coffee delivery and turn the grinding adjustment dial (fig. 8) one click clockwise towards "7" while the coffee mill is in operation. If after making at least 2 coffees delivery is still too slow, repeat the correction procedure, turning the grinding adjustment dial another click until delivery is correct (see the section: "Adjusting the coffee mill on page 12). If the problem persists, make sure the water tank is fully inserted, turn the hot water/steam dial to the I position and deliver a little water until the flow is regular.</p>
 <p>FLASH. + FLASH.</p>	<p>Too much coffee has been used.</p>	<p>Select a milder taste by turning the  dial or reduce the quantity of pre-ground coffee.</p>
 <p>FLASH. + FLASH.</p>  <p>FLASHING</p>	<p>The water circuit is empty</p>	<p>Turn the hot water/steam dial (B1) to the I position until delivery stops, then bring it back to the 0 position. If the alarm occurs while hot water or steam is being delivered, turn the dial to the 0 position, then resume delivery.</p>
 <p>ON</p>	<p>The inside of the appliance is very dirty.</p>	<p>Clean the inside of the appliance thoroughly, as described in the section "Cleaning". If the message is still displayed after cleaning, contact a service centre.</p>
 <p>FLASHING</p>	<p>The infuser has not been replaced after cleaning (A17).</p>	<p>Insert the infuser as described in the paragraph "Cleaning the infuser" (page 15).</p>
 <p>ON + ON</p>	<p>The infuser door (A16) is open.</p>	<p>Close the door.</p>
 <p>FLASHING</p>	<p>Indicates the hot water/steam dial must be turned (B1).</p>	<p>The dial (B1) must be turned.</p>

DISPOSAL



In compliance with European directive 2002/96/EC, the appliance must not be disposed of with household waste, but taken to an authorised waste separation and recycling centre.

TROUBLESHOOTING

Below is a list of some of the possible malfunctions.

If the problem cannot be resolved as described, contact Customer Services.

PROBLEM	POSSIBLE CAUSE	SOLUTION
The coffee is not hot.	The cups were not preheated.	Warm the cups by rinsing them with hot water (Please note: you can use the hot water function).
	The infuser (A17) has cooled down because 2/3 minutes have elapsed since the last coffee was made.	Before making the coffee, heat the infuser by rinsing using the rinse function (page 10).
	A low coffee temperature is set.	Set a higher coffee temperature in the menu (page11).
The coffee is weak or not creamy enough.	The coffee is ground too coarsely.	Turn the grinding adjustment dial one click anticlockwise towards "1" while the coffee mill is in operation (fig. 8). Continue one click at a time until coffee delivery is satisfactory. The effect is only visible after delivering 2 coffees (see the section: "Adjusting the coffee mill" on page 11).
	The coffee is unsuitable.	Use pre-ground coffee for espresso machines.
The coffee is delivered too slowly or a drop at a time.	The coffee is ground too finely.	Turn the grinding adjustment dial one click clockwise towards "7" while the coffee mill is in operation (fig. 8). Continue one click at a time until coffee delivery is satisfactory. The effect is only visible after delivering 2 coffees (see the section: "Adjusting the coffee mill" on page 11).
Coffee does not come out of one or both of the spouts.	The spouts are blocked.	Clean the spouts with a toothpick (fig. 22).
The milk is not frothed	Cappuccino maker dirty.	Clean the cappuccino maker as described in the corresponding section (page 13).
Steam delivery stops	A safety device stops steam delivery after 3 minutes.	Wait and then enable the steam function again.
The appliance does not come on	The plug on the cord (A22) is not plugged in.	Plug into the mains socket.
	The main switch (A15) is not turned on.	PRESS THE MAIN SWITCH (FIG. 4).
The infuser cannot be extracted	The appliance has not been turned off correctly	Turn the appliance off by pressing the  button (page 10).
The frothed milk has large bubbles	The milk is not cold enough or is not semi-skimmed.	You should ideally use skimmed or semi-skimmed milk at refrigerator temperature (about 5°C). If the result is not as you wished, try changing brand of milk.

The milk is not frothed	Cappuccino maker dirty.	Clean as described in the section "Cleaning the cappuccino maker after use" (page 13).
Steam delivery stops	A safety device stops steam delivery after 3 minutes.	Wait, and then enable the steam function again.

ELECTRICAL CONNECTION (UK ONLY)

Before using this appliance ensure that the voltage indicated on the product corresponds with the main voltage in your home, if you are in any doubt about your supply contact your local electricity company.

The flexible mains lead is supplied connected to a B.S. 1363 fused plug having a fuse of 13 amp capacity.

Should this plug not fit the socket outlets in your home, it should be cut off and replaced with a suitable plug, following the procedure outlined below.

Note: Such a plug cannot be used for any other appliance and should therefore be properly disposed of and not left where children might find it and plug it into a supply socket - with the obvious consequent danger.

Please note: We recommend the use of good quality plugs and wall sockets that can be switched off when the machine is not in use.

IMPORTANT: The wires in the mains lead fitted to this appliance are coloured in accordance with the following code:

GREEN AND YELLOW
BLUE
BROWN

EARTH
NEUTRAL
LIVE

Green and Yellow to Earth

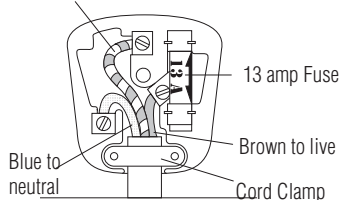

As the colours of the wires in the mains lead of this appliance may not correspond with the coloured markings identifying the terminals in your plug, proceed as follows:

- The wire which is coloured green and yellow must be connected to the terminal in the plug which is marked with the letter E or by the earth symbol  or coloured green or green and yellow.
- The wire which is coloured blue must be connected to the terminal which is marked with the letter N or coloured black.
- The wire which is coloured brown must be connected to the terminal which is marked with the letter L or coloured red.

When wiring the plug, ensure that all strands of wire are securely retained in each terminal. Do not forget to tighten the mains lead clamp on the plug. If your electricity supply point has only two pin socket outlets, or if you are in doubt, consult a qualified electrician.

Should the mains lead ever require replacement, it is essential that this operation be carried out by a qualified electrician and should only be replaced with a flexible cord of the same size.

After replacement of a fuse in the plug, the fuse cover must be refitted. If the fuse cover is lost, the plug must not be used until a replacement cover is obtained. The colour of the correct replacement fuse cover is that of the coloured insert in the base of the fuse recess or elsewhere on the plug. Always state this colour when ordering a replacement fuse cover.

Only 13amp replacement fuses which are approved to B.S. 1362 should be fitted.

This appliance conforms to the Norms EN 55014 regarding the suppression of radio interference.

Warning - this appliance must be earthed