

# OPTIMA pedestals with Top 1000 drawers

## FEATURES

- Two different depths: 600 mm, 800 mm
- Three configurations

## QUALITY STANDARD

- LST CEN/TR 14073-1:2004
- LST CEN 14073-2:2004
- LST CEN 14073-3:2004
- LST EN 14074:2004

## TECHNICAL INFORMATION

### Carcass

- Made of 18 mm MFC (melamine), 1 mm ABS edges.

### Drawers

- Front made of 18 mm MFC (melamine);
- Full extension metal drawers;
- Central locking;
- With anti-tilt;
- With soft closing function (pencil drawer excluded);
- For 600 mm depth pedestals, load max. 20 kg for file drawer, 6 kg for pencil drawer, 10 kg for other drawers;
- For 800 mm depth pedestals, load max. 30 kg for file drawer, 6 kg for pencil drawer, 15 kg for other drawers.

### Castors

- Twin wheel castor Ø37 mm;
- Max. 30 kg per castor.

### Handles

- EG, MG, AG, T1G, EX, MX, AX, T1X, MK, AK, T1K made from powder coated metal, hole for fixing – 128 mm.

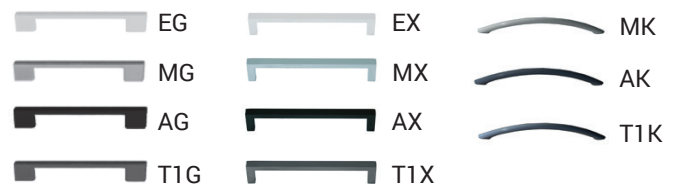

Handle type (colour + handle code)

## RANGE

Depth – 600 mm (drawer depth – 530 mm)

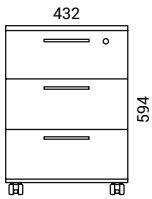

PGR636

- 3 metal drawers;
- Soft closing function;
- Central locking;
- Anti-tilt mechanism.

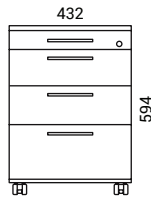

PGR640

- 1 pencil drawer;
- 3 metal drawers;
- Soft closing function (except pencil drawers);
- Central locking;
- Anti-tilt mechanism.

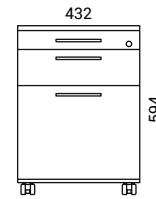

PGR632

- 1 pencil drawer;
- 2 metal drawers (filer drawer for A4 and foolscap included);
- Soft closing function (except pencil drawers);
- Central locking;
- Anti-tilt mechanism.

Depth – 800 mm (drawer depth – 730 mm)

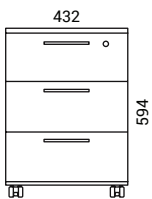

PGR836

- 3 metal drawers;
- Soft closing function;
- Central locking;
- Anti-tilt mechanism.

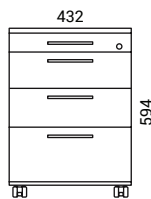

PGR840

- 1 pencil drawer;
- 3 metal drawers;
- Soft closing function (except pencil drawers);
- Central locking;
- Anti-tilt mechanism.

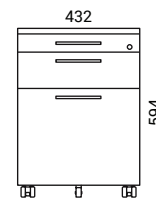

PGR832

- 1 pencil drawer;
- 2 metal drawers (filer drawer for A4 and foolscap included);
- Soft closing function (except pencil drawers);
- Central locking;
- Anti-tilt mechanism.

## ADDITIONAL INFORMATION

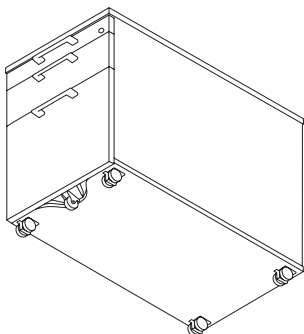

There is an additional rubber castor for file drawer stability when loaded max 30 kg. Also, the facade of PGR832 pedestal is extended to make the castor less visible.