



RDX4

OPERATION MANUAL

WARNING: THE CHARGING AND DISCHARGING OF RC HOBBY BATTERIES CAN BE DANGEROUS. FAILURE TO FOLLOW THE INSTRUCTIONS AND WARNINGS IN THIS MANUAL MAY RESULT IN PROPERTY DAMAGE AND/OR LOSS OF LIFE.

TABLE OF CONTENTS

INTRODUCTION	3
WARNINGS & SAFETY	4
PACKAGE CONTENTS	7
OPTIONAL EXTERNAL CHARGER	7
CHARGER LAYOUT	8
CHARGER SPECIFICATIONS	9
CHARGER FEATURES	10
PROGRAM FLOW CHART	12
BUTTON EXPLANATIONS	14
POWER & BATTERY CONNECTIONS	15
CHARGER OPERATION	16
LITHIUM PROGRAM (LiPo/LiFe/LiIo/LiHV)	18
NiMH/NiCd PROGRAM	19
Pb LEAD-ACID PROGRAM	20
Charge Manager	21
HITEC APP CONTROL	22
USB TYPE-C PD/QC3.0 OUTPUT	22
DC POWER	23
OPTIONAL PARTS	24
CHARGER SETTINGS	24
SYSTEM SETTINGS	25
WARNING & ERROR MESSAGES	26
FIRMWARE UPDATE NOTICE	27
DECLARATION OF CONFORMITY	27
REGULATORY/COMPLIANCE INFORMATION	28
WARRANTY, SERVICE & REPAIR	28

INTRODUCTION







Congratulations on purchasing Hitec's RDX4 AC/DC Multi-Function Smart Charger. The RDX4 features independent circuits allowing you to charge four batteries simultaneously, regardless of chemistry or capacity. The RDX4 also features integrated balancing for six-cell Lithium-Polymer (LiPo), Lithium-Ferrite (LiFe) and Lithium-Ion (LiIo), as well as the latest high voltage Lithium-Polymer (LiHV) batteries.

Although simple to use, the RDX4 does require some basic knowledge for successful and safe operation. The operating instructions included here are designed to ensure that you quickly become familiar with its functions. It is important that you read through this manual in its entirety. Read attentively and completely the Operating Instructions, Warning and Safety Notes BEFORE attempting to use your new charger for the first time.

PLEASE READ THIS ENTIRE OPERATING MANUAL BEFORE USING THE RDX4 CHARGER. IF YOU ARE UNSURE OF ITS PROPER OPERATION AFTER READING THE MANUAL, PLEASE SEEK ADVICE FROM AN EXPERIENCED HOBBYIST OR SOMEONE FAMILIAR WITH PROPER BATTERY CHARGING PROCEDURES.



THE CHARGING AND DISCHARGING OF RC HOBBY BATTERIES CAN BE DANGEROUS. FAILURE TO FOLLOW THESE EXPLICIT WARNINGS CAN RESULT IN PROPERTY DAMAGE AND/OR LOSS OF LIFE.

-  NEVER LEAVE YOUR CHARGER UNATTENDED WHILE IN OPERATION.
-  NEVER CHARGE ON OR AROUND COMBUSTIBLE MATERIALS.
-  NEVER CHARGE A DAMAGED BATTERY PACK.
-  LOW COST, NO-NAME BATTERY PACKS POSE THE MOST DANGER. WE RECOMMEND YOU ONLY USE BATTERY PACKS THAT ARE SOLD AND WARRANTIED BY A REPUTABLE COMPANY.
-  IT IS HIGHLY RECOMMENDED THAT YOU UTILIZE A SAFETY DEVICE SUCH AS A STEEL CASE OR LiPo SACK™ WHILE CHARGING LITHIUM CHEMISTRY BATTERIES.
-  IT IS HIGHLY RECOMMENDED THAT YOU KEEP AN OPERABLE "CLASS A" FIRE EXTINGUISHER IN THE CHARGING AREA.









FAILURE TO FOLLOW THESE WARNINGS CAN BE CONSIDERED NEGLIGENCE BY THE OPERATOR AND MAY NEGATE ANY CLAIMS FOR DAMAGES INCURRED.

WARNINGS & SAFETY

Hitec Group USA, Inc. (Hitec RCD USA) will not be held responsible for any damages or injuries that may occur by persons who fail to follow these warnings or who fail to properly follow the instructions in this manual.



NEVER LEAVE THE CHARGER UNATTENDED WHILE IT IS CONNECTED TO ITS POWER SOURCE. IF ANY MALFUNCTION IS FOUND, TERMINATE THE PROCESS AT ONCE AND REFER TO THE OPERATION MANUAL.

-  The allowable AC input voltage is 100 - 240V AC
-  The allowable DC input voltage is 11-18V DC.
-  Keep the charger away from dust, damp, rain, heat, direct sunlight and excessive vibration.
-  If the charger is dropped or suffers any type of impact, it should be inspected by an authorized service station before using it again.
-  This charger and the battery should be put on a heat-resistant, non-flammable and non-conductive surface.
-  Never place a charger on a car seat, carpet or similar surface. Keep all flammable volatile materials away from the operating area.
-  Make sure you know the specifications of the battery to be charged or discharged to ensure it meets the requirements of this charger. If the program is set up incorrectly, the battery and charger can be damaged.
-  Fire or explosion can occur due to overcharging.
-  Never attempt to charge or discharge the following types of batteries:
 - A battery fitted with an integral charge circuit or a protection circuit.
 - A battery pack which consists of different types of cells (including different manufacturer's cells).
 - A battery that is non-rechargeable (these pose an explosion hazard).
 - A faulty or damaged battery.
 - Batteries installed in a device or which are electrically linked to other components.
 - Batteries that are not expressly stated by the manufacturer to be suitable for the currents the charger delivers during the charge process.

PLEASE CHECK THE FOLLOWING POINTS BEFORE YOU BEGIN CHARGING:

- Did you select the appropriate program suitable for the type of battery you are charging?
- Did you set up the adequate current for charging or discharging?
- Have you checked the battery voltage? Lithium battery packs can be wired in parallel and in series, i.e. a 2-cell pack can be 3.7V (in parallel) or 7.4V (in series).
- Have you checked that all connections are firm and secure?
- Make sure there are no intermittent contacts at any point in the circuit.

STANDARD BATTERY PARAMETERS

	LiPo	Lilon	LiFe	LiHV	NiMH	NiCd	Pb
Nominal Voltage	3.7V/cell	3.6V/cell	3.3V/cell	3.8V/cell	1.2V/cell	1.2V/cell	2.0V/cell
Max Charge Voltage	4.2V/cell	4.1V/cell	3.6V/cell	4.35V/cell	1.5V/cell	1.5V/cell	2.4V/cell
Storage Voltage	3.8V/cell	3.7V/cell	3.3V/cell	3.85V/cell	—	—	—
Fast Charge Current	≤1C	≤1C	≤4C	≤1C	1C-2C	1C-2C	≤0.4C
Min. Discharge Voltage	3.0-3.3V per cell	2.9-3.2V per cell	2.6-2.9V per cell	3.1-3.4V per cell	0.1-1.1V per cell	0.1-1.1V per cell	1.8-2.0V per cell



WARNING

WHEN ADJUSTING YOUR RDX4 CHARGING PARAMETERS, BE SURE YOU SELECT THE PROPER BATTERY TYPE AND CELL VOLTAGE FOR THE TYPE OF CELL YOU ARE CHARGING. CHARGING BATTERIES WITH THE WRONG SETTINGS MAY CAUSE THE CELLS TO BURST, CATCH FIRE OR EXPLODE.

CHARGING

Before charging your batteries, it is critical that you determine the maximum allowable charge rate for your batteries. The RDX4 is capable of charging at high rates that may not be suitable or safe for your particular batteries. For example, Lithium cells are typically safe to charge at 1C, or the total mAh÷1000. A 1200mAh battery would have a 1C charge rate of 1.2 amps. A 4200mAh battery would have a 1C charge rate of 4.2 amps. Some manufacturers are offering Lithium cells that can be charged at greater than 1C but this should ALWAYS be verified before charging a Lithium battery at rates higher than 1C. Voltage is just as critical as the charging amperage rate and this is determined by the number of cells in series, or "S". For example, a 3S LiPo is rated at 11.1 volts ("S" multiplied by a single LiPo cell with a nominal voltage of 3.7 volts DC. 3 cells x 3.7 volts each equals 11.1 volts DC).

PACKAGE CONTENTS

Connect the battery's main leads to the charger output: Red is positive and black is negative. Keep in mind that the gauge or thickness of your charging leads from the RDX4 to your battery must be of an acceptable current rating to handle the applied charge current. For maximum safety and charging effectiveness, always match or exceed the main battery lead rating when assembling or selecting your charging leads. If you charge a battery at a high current rate (amperage) with a charging lead not rated for the chosen amperage, the wire could get hot, catch fire, short out and/or potentially destroy your battery and the charger. When in doubt, always use a higher gauge wire (lower AWG number). It is common to see charging leads constructed of 14AWG, 16AWG or 18AWG wire.

Always refer to recommendations from your battery manufacturer for your specific battery type and size before initiating a charge or discharge process.

DO NOT ATTEMPT TO DISASSEMBLE OR MODIFY ANY BATTERY PACKS.

DISCHARGING

The RDX4 discharging functions are for two specific purposes:

- Refreshing the capacity of a Nickel-based battery that has lost capacity over time (NiMH or NiCd).
- Reducing the voltage of a Lithium battery for safe storage.



WARNING

LITHIUM CHEMISTRY BATTERY PACKS SHOULD ONLY BE DISCHARGED TO THEIR MINIMUM SAFE VOLTAGE, NO LOWER. DEEP DISCHARGING A LITHIUM CELL WILL DO PERMANENT DAMAGE. REFER TO THE STANDARD BATTERY PARAMETERS TABLE ON PAGE 5 OF THIS MANUAL FOR MINIMUM DISCHARGE VOLTAGES.

LIPO & LIHV CHARGE/DISCHARGE CYCLING

Lithium batteries are known to reach full capacity after a break-in period of about 10 charge/discharge cycles. We do not recommend you use the RDX4 charger to do this; normal use and recharging will achieve the same results. If you wish to perform a Lithium break-in on the bench with the RDX4, discharging to minimum acceptable voltages and performing a balance charge at 1C maximum rate is recommended. If you choose to break in your Lithium batteries under normal use, charging at only 1C for the first ten cycles will help ensure full performance and service life from your Lithium cells.

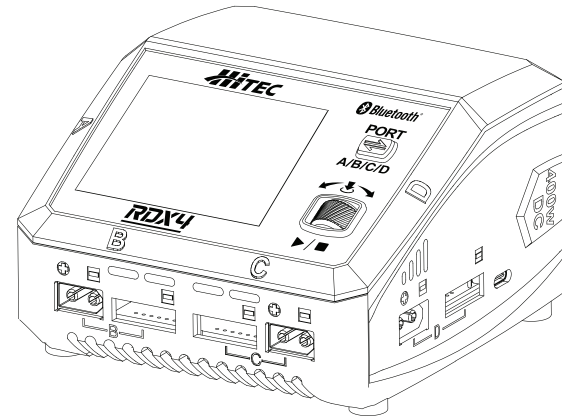

RDX4 MULTICHARGER

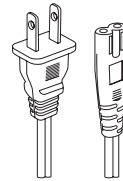

AC POWER CORD

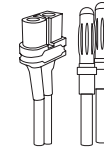

DC CORD

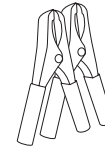

CLAMPS

CHARGER LAYOUT

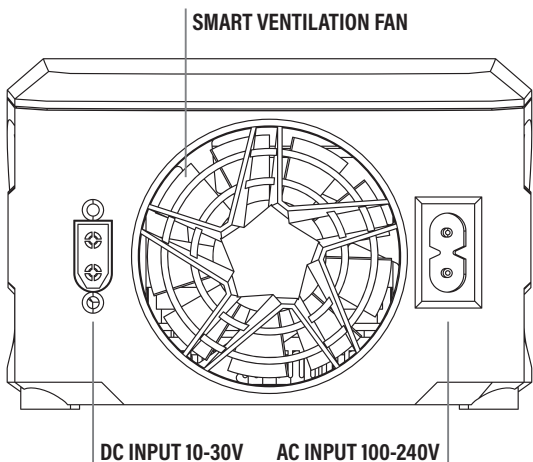
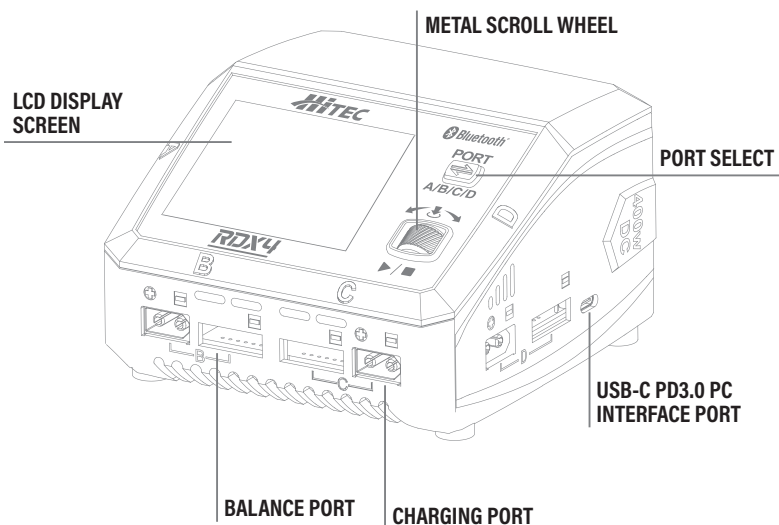

CHARGER SPECIFICATIONS

INPUT VOLTAGE	AC	100-240V (50/60Hz)
	DC	10.0-30.0V
INPUT CURRENT	DC	30.0A
	AC	100W/port MAX; 200W Total PD3.0: 20W MAX
CHARGE POWER	DC	100W/port MAX; 400W Total PD3.0: 20W MAX
	MAIN PORT	5W/port
DISCHARGE POWER	MAIN PORT + BALANCE PORT	25W MAX (LiPo/6S)
CHARGE CURRENT	LiPo/LiFe/LiIo/LiHV/NiMH/NiCd/Pb	0.1-10.0A
DISCHARGE CURRENT	LiPo/LiFe/LiIo/LiHV/NiMH/NiCd/Pb	0.1-2.0A
BALANCE CURRENT	LiPo/LiFe/LiIo/LiHV	800mA MAX
TRICKLE CURRENT	NiMH/NiCd	50-300mA & OFF
	LiPo/LiFe/LiIo/LiHV	1-6S
BATTERY TYPES	NiMH/NiCd	2-15S
	Pb	3S/6S/12S
	LiPo/LiFe/LiIo/LiHV	Balance CHG, Charge, Discharge, Storage
WORKING MODES	NiMH/NiCd	Charge, Discharge, Re-peak, CYCLE_D_C, CYCLE_C_D
	Pb	Normal, AGM Charge, Cold Charge, Discharge
	VOLTAGE	1.0-30.0V
DC POWER SUPPLY	CURRENT	0.1-10.0A
	QC3.0	5V≐3A, 9V≐2A, 12V≐1.5A 18W
USB TYPE-C OUTPUT	PD	5V≐3A, 9V≐2.2A, 12V≐1.67A 20W
	WORKING ENVR.	32°F-104°F 10%-80% Humidity
STORAGE ENVR.	14°F-140°F 20%-70% Humidity	
SIZE	—	4.8 x 4.7 x 3.1 in
NET WEIGHT	—	1.5 lbs.

CHARGER FEATURES

QUAD-CHANNEL CHARGER

Hitec's RDX4 allows you to plug four batteries into the charger simultaneously. The batteries being charged do not need to have the same configuration. You can connect different battery chemistries (NiMH/ NiCd/LiPo/LiFe/LiLo/LiHV/Pb) into any of the charging ports.

INTERNAL INDEPENDENT LITHIUM BATTERY BALANCER

The RDX4 employs an individual-cell-voltage balancer.

INDEPENDENT CELL BALANCING WHILE DISCHARGING

During the discharge process, the RDX4 monitors and balances each cell of the battery individually. If the voltage of any single cell reads abnormally, an error message will display and end the process automatically for protection.

ADAPTABLE TO VARIOUS TYPES OF LITHIUM BATTERIES

The RDX4 will charge a variety of Lithium batteries such as LiPo, LiFe, LiLo and the new higher voltage LiHV batteries.

MULTIPLE LITHIUM BATTERY CHARGE MODES

BALANCE CHARGE

In this mode, each cell is monitored and if some are at higher voltages than the others, they are discharged to equalize the voltage between all the cells and keep the pack in optimum condition. We highly recommend using Balance Charge as it is the safest and best way to charge Lithium batteries.

CHARGE

This mode charges the pack without balancing the cells. Connecting the balance lead is still recommended so you can monitor each cell's voltage manually by scrolling to the left with the Jog Dial. Note: If the cells are more than 0.02V off from each other, Balance Charge should be used to equalize the pack.

STORAGE

This mode charges or discharges the pack to 50% capacity so that it can be safely stored when not in normal use. If you do NOT plan on using your Lithium pack within 24-48 hours of being fully charged or fully discharged, Storage Mode is recommended to optimize maximum lifespan and performance and reduce the risk of the gases forming, causing the pack to puff.

TERMINAL VOLTAGE CONTROL (TVC):

For experienced users ONLY, the charger's end voltage can be reset up to 0.02v/cell higher.



WARNING

DEFAULT SETTING IS RECOMMENDED. ONLY CHANGE IN A CONTROLLED ENVIRONMENT. ALWAYS MONITOR THE BATTERY DURING THE CHARGE PROCESS.

CYCLIC CHARGING / DISCHARGING:

A battery can be cycled 1 to 5 times consecutively. This process is normally used for NiCd or NiMH packs that have lost capacity over time.

RE-PEAK MODE OF NIMH/NICD BATTERIES:

In Re-Peak charge mode, the charger can peak charge the battery once, twice, or three times in a row automatically. This function is useful for ensuring a full battery charge.

DELTA-PEAK SENSITIVITY FOR NIMH/NICD:

This function determines the amount of voltage drop in MV that must be achieved for the Delta-Peak algorithm to automatically terminate the charge process. This can be raised for packs that have a tendency to "False Peak" at the default setting.

BATTERY RESISTANCE METER:

The user can check not only the MAIN pack voltage but each individual cell and its resistance as well.

CAPACITY CUT-OFF LIMIT:

This feature allows the user to set a limit for the maximum mAhs that can be put into the pack. Once this limit is reached, the charge process will automatically terminate, and "OVER CHARGE CAPACITY LIMIT" will be displayed. Default is 12000mAh, so set this accordingly to the rated capacity of the pack. To ensure the pack gets fully charged, this setting should be at least 10% higher than the rated capacity on the pack or turned OFF.

SAFETY TIMER:

Protect your battery by setting a maximum time limit for charging. Once this limit is reached, the charge process will automatically terminate, and "OVER TIME LIMIT" will be displayed. Default is 240 minutes, so adjust as needed depending on the charge rate and capacity of the pack.

BATTERY CHARGE PERCENTAGE:

The battery charge percentage is displayed in real time once you are charging.

POWER SUPPLY:

With the built in Power Supply function, you can power devices with up to 27V @ 10A.



NOTE

IF THE POWER SUPPLY FUNCTION IS ACTIVATED, CHARGING IS DISABLED.

BUTTON EXPLANATIONS

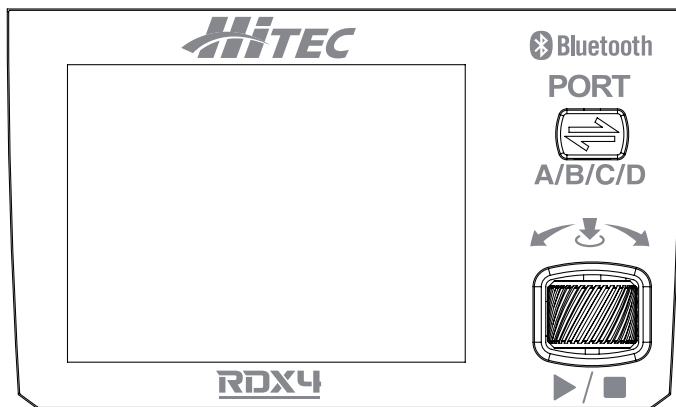

PORT SWITCH BUTTON

Switch between Port A, B, C & D.

Short-press to exit the system settings menu.



METAL SCROLL WHEEL

Short-press to enter the menu or confirm settings.

Scroll to select menus or parameters.

Press and hold for three seconds under the main interface to enter into charger's system settings menu.



WARNING

BEFORE YOU BEGIN CONNECTING YOUR BATTERY, MAKE SURE YOU HAVE READ AND UNDERSTOOD ALL OF THE WARNINGS AND SAFETY INFORMATION CONTAINED IN THIS MANUAL.

POWER & BATTERY CONNECTIONS

1 CONNECT TO A POWER SOURCE

There are two input options for the RDX4: AC (100-240V) or DC (10-30V).

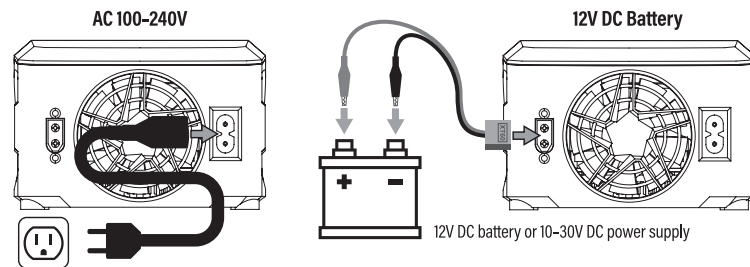

WARNING

TO AVOID SHORT CIRCUITS, ALWAYS CONNECT THE CHARGE LEADS TO THE CHARGER FIRST, AND THEN TO THE BATTERY. REVERSE THE SEQUENCE WHEN DISCONNECTING THE PACK.

2 CONNECT THE BATTERY

A) LiPo Battery Connection with Balance Adapter

For safety reasons, it is highly recommended to charge Lithium batteries (LiPo, Lilon, LiFe and LiHV) using Balance CHG mode unless the battery comes without a balance connector.

The battery connector must be connected to the charger with the black wire aligned with the negative marking. Ensure correct polarity!

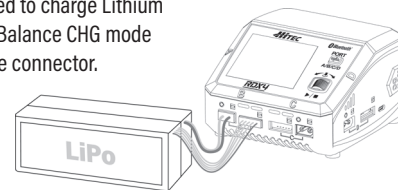

B) NiMH/NiCd or Pb Battery Connection.

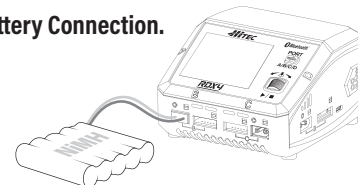

CHARGER OPERATION

INITIAL SETUP OF THE CHARGER

After connecting the battery, you are now ready to setup the charger to charge your specific type of battery. When the charger is first powered on, the last program selected will be displayed. If this is not the battery you plan on working with, then you will need to make changes to the operation programming based on the following instruction.



WARNING

BEFORE SELECTING AN OPERATION, IT IS CRITICAL THAT YOU KNOW THE TYPE OF BATTERY YOU ARE WORKING WITH AND WHAT THE MANUFACTURER RECOMMENDATIONS ARE FOR CHARGING OR DISCHARGING. FAILURE TO FOLLOW THE MANUFACTURER'S RECOMMENDATIONS CAN RESULT IN DAMAGE TO THE BATTERY AND CREATE AN EXPLOSION HAZARD.

AVAILABLE OPERATIONS

Depending on battery type, different operations will be available. This chart shows which operations are available for the different types of batteries the RDX4 is capable of working with.



WARNING

BEFORE YOU BEGIN CHARGING YOUR BATTERY, MAKE SURE YOU HAVE READ AND UNDERSTOOD ALL OF THE WARNINGS AND SAFETY INFORMATION CONTAINED IN THIS ENTIRE MANUAL.

BATTERY	OPERATION	OPERATION DESCRIPTION
LiPo Lilo LiFe LiHV	Balance CHG	This mode is to balance charge the lithium battery based on the charging rate. It can balance each cell of the battery.
	Charge	This mode is to charge the lithium battery based on the charging rate selected.
	Storage	This mode is to store the battery via charging or discharging its voltage to a specific storage value.
	Discharge	This mode is to discharge the lithium battery based on the discharging rate selected.
	Cycle	This mode is to cycle discharge > charge the lithium battery to get the maximum power of the battery. It's only available under the Balance CHG & Parallel charge mode for the lithium battery.
NiMH NiCd	Charge	This mode is to charge the NiMH/NiCd battery based on the charging rate selected.
	Re-Peak	In re-peak charge mode, the charger can peak charge the battery twice in a row automatically. This is good for confirming the battery is fully charged, and for checking how well the battery receives fast charges.
	Cycle_C_D	Select 1 to 5 continuous charge->discharge cycles to refresh and restore the performance of NiMH/NiCd batteries.
	Cycle_D_C	Select 1 to 5 continuous discharge->charge cycles to refresh and restore the performance of NiMH/NiCd batteries.
	Discharge	This mode is to discharge the NiMH/NiCd battery based on the discharging rate selected.
LEAD ACID Pb	Normal	This mode is to charge the Pb battery based on the charging rate selected.
	AGM Charge	This mode is to charge the AGM battery based on the charging rate selected.
	Cold Charge	This mode is to charge the Pb battery under a low temperature based on the charging rate selected.
	Discharge	This mode is to discharge the Pb battery based on the discharging rate selected.

LITHIUM PROGRAM (LiPo/LiFe/LiIo/LiHV)

From the main menu, press the scroll button to enter the Charger's settings.

CH A CHARGE SETTING	
Battery Type	LiPo
Battery Cell	6S(22.2V)
Task	Balance CHG
Condition	4.2V
Current	10.0A
Start	
Back	

1 SELECT BATTERY TYPE

Using the scroll wheel, select the type of battery connected.

Battery Type	LiPo
	LiIo
	LiFe
	LiHV
	NiMH
	NiCd

Press scroll wheel to confirm.

2 SELECT BATTERY CELL

Using the scroll wheel, select the cell count of the battery connected.

Battery Cell	1S (3.7V)
	2S (7.4V)
	3S (11.1V)
	4S (14.8V)
	5S (18.5V)
	6S (22.2V)

Press scroll wheel to confirm.

3 SELECT TASK

Using the scroll wheel, select the charge mode. LiPo Balance is recommended.

Task	Balance CHG
	Charge
	Storage
	Discharge

Press scroll wheel to confirm.

4 SELECT CONDITION

Using the scroll wheel, select the end voltage. The default is 4.20V, recommended to skip.

Condition	4.18V
	4.19V
	4.19V
	4.20V
	4.21V
	4.22V

Press scroll wheel to confirm.

5 SELECT CURRENT

Using the scroll wheel, select the charge current. 1C charge rate is recommended.

(1C 500mAh = 5.0A)
Press scroll wheel to confirm.

Current	0.1A
	0.2A
	19.9A
	20.0A

6 START/STOP

Using the scroll wheel, select Start and press to initiate the charge process using the selected settings.

Start	
-------	--

Press the scroll button again to stop the charge process and return to settings.

NiMH/NiCd PROGRAM

From the main menu, press the scroll button to enter the Charger's settings.

1 SELECT BATTERY TYPE

Using the scroll wheel, select the type of battery connected.

Battery Type	LiPo
	LiIo
	LiFe
	LiHV
	NiMH
	NiCd
	Pb

Press scroll wheel to confirm.

2 SELECT BATTERY CELL

Using the scroll wheel, select the cell count of the battery connected.

Battery Cell	4S
	5S
	14S
	15S

Press scroll wheel to confirm.

3 SELECT TASK

Using the scroll wheel, select the charge mode. LiPo Balance is recommended.

Task	Charge
	Re-Peak
	CYCLE_C_D
	CYCLE_D_C

Press scroll wheel to confirm.

4 SELECT CONDITION

Using the scroll wheel, select the delta voltage. The default is -6mV, recommended to skip.

Condition	-3mV
	-4mV
	-5mV
	-6mV
	-7mV
	-8mV
	-9mV

Press scroll wheel to confirm.

5 SELECT CURRENT

Using the scroll wheel, select the charge current. 1C charge rate is recommended.

(1C 500mAh = 5.0A)
Press scroll wheel to confirm.

Current	0.1A
	0.2A
	19.9A
	20.0A

6 START/STOP

Using the scroll wheel, select Start and press to initiate the charge process using the selected settings.

Start	
-------	--

Press the scroll button again to stop the charge process and return to settings.

Pb LEAD-ACID PROGRAM

From the main menu, press the scroll button to enter the Charger's settings.

CH A CHARGE SETTING	
Battery Type	Pb
Battery Cell	6S(12.0V)
Task	AGM Charge
Condition	2.45V
Current	5.0A
Start	
Back	

1 SELECT BATTERY TYPE

Using the scroll wheel, select the type of battery connected.

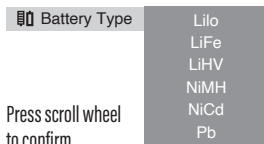

2 SELECT BATTERY CELL

Using the scroll wheel, select the cell count of the battery connected.

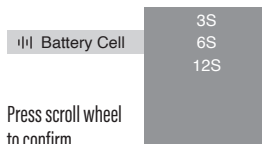

3 SELECT TASK

Using the scroll wheel, select the charge mode.

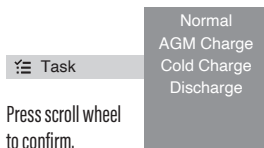

4 SELECT CONDITION

Using the scroll wheel, select the end voltage. Only available in discharge mode.

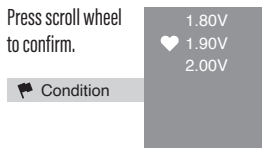

5 SELECT CURRENT

Using the scroll wheel, select the charge current.

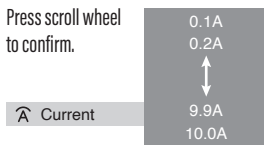

6 START/STOP

Using the scroll wheel, select Start and press to initiate the charge process using the selected settings.

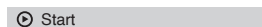

CHARGE MANAGER

RDX4 is capable of charging and discharge monitoring through the computer. Various parameters, including charge time and capacity, can be displayed visually, as well as charge current and voltage in a curve.

In addition, battery performance can be analyzed through the Charge Manager program.

1. Download the latest Charge Manager onto your PC or Mac. Unzip and open it to install after downloading.
2. Power on your RDX4.

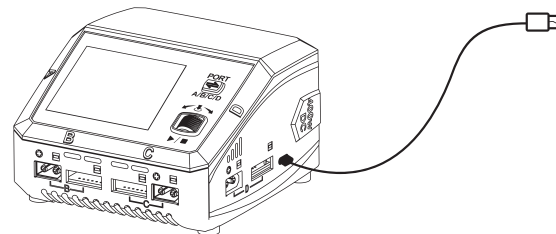

3. Connect the RDX4 to your computer via a USB type-C cable.
4. On the top left of the Charge Manager, choose the option of Charge.
5. Set the parameters on the corresponding ports. Click to start the program after setting up.

HITEC LINKPOWER X

The charger has a built-in Bluetooth 5.0 module, allowing users to easily control the RDX4 charger analyze the battery through the Hitec LinkPower X app. Even when you are racing outside, you can test and check the battery performance and curve anytime and anywhere.



USB TYPE-C PD/QC3.0 OUTPUT

The RDX4 is capable of charging your mobile devices in addition to batteries. Simply plug your device into the charger's USB Type-C port and enjoy up to 20W of charging power!

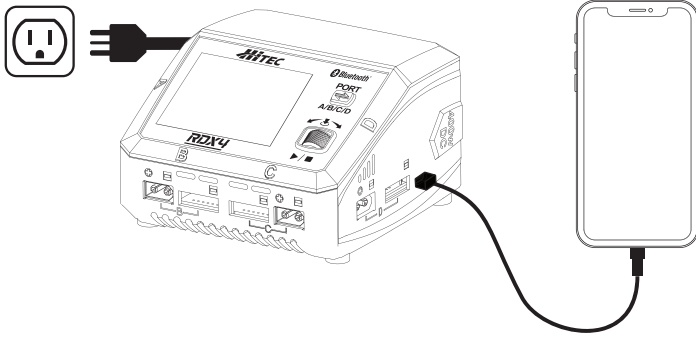

DC POWER

The RDX4 is capable of powering external DC devices.

1. On the main interface, hold the ENTER button for a few seconds to enter the system setting.
2. Select the option of DC Power, then adjust the output voltage and current.
3. Press Start to activate the power function after setting up.
4. Connect your desired DC equipment.

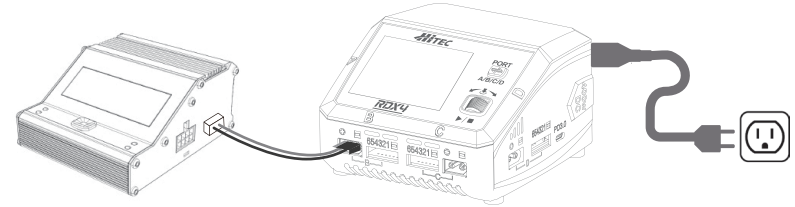

ON THE DC POWER INTERFACE, PRESS THE PORT BUTTON TO TOGGLE BETWEEN PORTS.



PLEASE MAKE SURE THERE IS NOTHING CONNECTED TO THE PORT BEFORE SELECTING THIS SETTING.

OPTIONAL PARTS



XT60 to EC3 Charging Connector
Part No. 44180



XT60 to EC5 Charging Connector
Part No. 44182



XT60 to 4 or 5mm Bullet w/XH
Part No. 44183

CHARGER SETTINGS

On the main interface, press the ENTER button to enter charging settings, in which you can toggle between A/B ports by pressing the Port button.

MENU	DEFINITION
BATTERY TYPE	Select your desired battery type (LiPo, Lilo, LiFe, LiHV, Pb, NiMH, NiCd).
BATTERY CELL	Select the number of battery cells corresponding to the battery type (Li-xx: 1-6S, Ni-xx: 1-15S, Pb: 3S/6S/12S).
TASK	Select the program to be performed (Balance CHG, Charge, Storage, Discharge, etc.).
CONDITION	Set the cut-off voltage as per the task.
CURRENT	Set the charge or discharge current.
START	Start the current program.
BACK	Back to the main interface.

SYSTEM SETTINGS

MENU	OPTION	SPECIFICATION
TASK PARAMETERS	Safety Timer	Customize a period for program protection.
	Max. Capacity	Customize the protection of capacity.
	Trickle Charge	Enable / disable trickle charge.
	Back	Back to the previous interface.
SYSTEM SETTINGS	Language	Select your desired system language.
	Max. Input Power	The maximum charge power AC Input: 200W DC Input: 800W
	Min. Input Voltage	In DC Input, set the minimum voltage for input protection.
	LCD Backlight	Adjust the brightness of the screen.
	Volume	Adjust the volume of the key and beep.
	Completion Signal	Choose the way you'd like to be reminded when the program completes.
	Back	Back to the previous interface.
DC POWER	Voltage	Set the output voltage (10.0-30.0V).
	Current	Set the output current (30.0-35.0A).
	Start	Enable DC power output and return to the main interface.
	Back	Back to the previous interface.
POWER FOR TIRE WARMER - A	N/A	Activate to power the after market Tire Warmer on Port A.
BATTERY METER	N/A	Measure the battery voltage and internal resistance (Toggle between A/B ports by pressing the Port button).
SYSTEM SELF-CHECKING	N/A	
FACTORY SETTINGS	N/A	Restore to the factory settings.
SYSTEM INFO	N/A	Check the current system status.
SYSTEM UPGRADE	N/A	Upgrade the system.
BACK	N/A	Back to the previous interface.

WARNING & ERROR MESSAGES

In the event of a fault, the charger will display an error message and sound an alarm.

ERROR MESSAGE	EXPLANATION
Error: DC Input Low!	DC input voltage is lower than preset!
Error: DC Input High!	DC input voltage is higher than preset!
Error: Battery Break!	The battery may be damaged or discharged too low!
Cell Error	The cells do not match.
Battery Type Error!	The battery type is wrong!
Error: Overcharge!	The battery is overcharged!
Error: Over Time!	The program is timed out!
Error: Internal Temp. Too High!	The internal temperature is high!
Error: Battery Temp. Too High!	The battery temperature is high!
Error: Over Load!	The charger is overloaded!
Error: Reversed Polarity	The battery connection is reversed.
Error: Fully Charged	The battery is fully charged already!
Error: Outlet Overload	The output is overloaded.
Error: Balance Connection Break	The balance connection is disconnected.
Error: Cell Volt Diff.	The voltage difference between each cell is high.
Error: AC to DC Too Low!	The input voltage is too low.
Error: Power Setting Error	The DC power setting is incorrect.

FIRMWARE UPDATE NOTICE

To recover from a firmware upgrade failure, please follow these steps:

1. Hold the STOP and ENTER buttons simultaneously, then connect the power cord; the RDX4 will power on with a blue screen notice.
2. Connect the RDX4 to your computer via a Type-C USB cable.
3. Launch the Charge Manager on your PC or Mac.
4. When the status shows CONNECTED, click to check for new firmware.
5. Click to upgrade after detecting a new firmware.
6. Wait for the progress bar to finish and reach 100%.



NOTE

THE PROCESS WILL TAKE ABOUT 5 MINUTES. FIRMWARE CAN ALSO BE UPDATED THROUGH THE LINKPOWER X MOBILE APP.

DECLARATION OF CONFORMITY

The RDX4 satisfies all relevant and mandatory CE directives and FCC Part 15 Subpart B.

STANDARDS	TITLE	RESULT
EN 60335-1	Household and similar electrical appliances - Safety -Part 1: General requirements	Conform
EN 60335-2-29	Household and similar electrical appliances – Safety – Part 2-29: Particular requirements for battery chargers.	Conform
EN 55014-1	Electromagnetic compatibility – Requirements for household appliances, electric tools and similar apparatus - Part 1: Emission	Conform
EN 55014-2	Electromagnetic compatibility – Requirements for household appliances, electric tools and similar apparatus – Part 2: Immunity Product Family Standard	Conform
EN 61000-3-2	Electromagnetic compatibility (EMC) – Part 3-2: Limits for harmonic current emissions (equipment input current up to and including 16 A per phase)	Conform
EN 61000-3-3	Electromagnetic compatibility (EMC) - Part 3-3: Limitation of voltage supply systems for equipment with rated current ≤ 16 A.	Conform
FCC Part Subpart 15B	Title 47 Telecommunication PART 15 - RADIO FREQUENCY DEVICES Subpart B - Unintentional Radiators	Conform

REGULATORY/COMPLIANCE INFORMATION

FCC NOTE

This device complies with Part 15 of the FCC rules. Operation is subject to the following two conditions: (1) this device may not cause harmful interference, and (2) this device must accept any interference received, including interference that may cause undesired operation. The manufacturer is not responsible for any radio or TV interference caused by unauthorized modifications or change to this equipment. Such modifications or change could void the user's authority to operate the equipment.

This equipment has been tested and found to comply with the limits for a Class B digital device, pursuant to part 15 of the FCC Rules. These limits are designed to provide reasonable protection against harmful interference in a residential installation. This equipment generates, uses and can radiate radio frequency energy and, if not installed and used in accordance with the instructions, may cause harmful interference to radio communications. However, there is no guarantee that interference will not occur in a particular installation. If this equipment does cause harmful interference to radio or television reception, which can be determined by turning the equipment off and on, the user is encouraged to try to correct the interference by one or more of the following measures:

- Reorient or relocate the receiving antenna.
- Increase the separation between the equipment and receiver.
- Connect the equipment into an outlet on a circuit different from that to which the receiver is connected.
- Consult the dealer or an experienced radio/TV technician for help.

To maintain compliance with FCC's RF exposure guidelines, this equipment should be installed and operated with a minimum distance of 20cm between the radiator and your body.

Hitec's RDX4 complies with FCC Part 15 Subpart B: 2019.

WARRANTY, SERVICE & REPAIR

LIABILITY EXCLUSION

This charger is designed and approved exclusively for use with the types of batteries stated in this Operation Manual. Hitec RCD USA accepts no liability of any kind if the charger is used for any purpose other than that stated. We are unable to ensure that you follow the instructions supplied with the charger, and we have no control over the methods you employ for using, operating and maintaining the device. For this reason, we are obliged to deny all liability for loss, damage or costs which are incurred due to any misuse or operation of our products. Unless otherwise prescribed by law, our obligation to pay compensation, regardless of the legal argument employed, is limited to the invoice value of Hitec RCD USA products which were immediately and directly involved in the event in which the damage occurred.

ONE YEAR LIMITED WARRANTY

For a period of one year from the date of purchase, HITEC RCD USA shall REPAIR OR REPLACE, at our option, defective equipment covered by this warranty. Otherwise, the purchaser and/or consumer is responsible for any charges for the repair or replacement of the charger. This warranty does not cover cosmetic damages and damages due to acts of God, accident, misuse, abuse, negligence, improper installation, or damages caused by alterations by unauthorized persons or entities. This warranty only applies to the original purchaser of this product and for products purchased and used in the United States of America, Canada and Mexico. Plastic cases are not covered by this warranty.

THIS WARRANTY IS IN LIEU OF ANY AND ALL OTHER WARRANTIES, WHETHER FOR MERCHANTABILITY OR FITNESS FOR A PARTICULAR PURPOSE AND WHETHER EXPRESS OR IMPLIED. REPAIR OR REPLACEMENT AS PROVIDED UNDER THIS WARRANTY IS THE EXCLUSIVE REMEDY. HITEC RCD USA SHALL NOT BE LIABLE FOR ANY INCIDENTAL OR CONSEQUENTIAL DAMAGES FOR BREACH OF ANY EXPRESS OR IMPLIED WARRANTY RELATING TO THIS PRODUCT, EXCEPT TO THE EXTENT PROHIBITED BY APPLICABLE LAW. ANY IMPLIED WARRANTY OF MERCHANTABILITY OR FITNESS FOR A PARTICULAR PURPOSE ON THIS PRODUCT IS LIMITED TO THE DURATION OF THIS WARRANTY, REPAIR AND SERVICE.



THE RDX4 CHARGER WARRANTY IS VOID IF SOLD AND/OR OPERATED OUTSIDE THE UNITED STATES.

SERVICE AND REPAIR INFORMATION

To have your Hitec charger serviced:

1. Visit the Hitec website at HitecRCD.com and download the service request form.
2. Fill out the service request form completely and include a copy of your original receipt showing the purchase date.
3. Package your product in its original packaging or use a suspension-type packaging (foam peanuts or crumpled newspaper). Hitec RCD USA shall not be responsible for goods damaged in transit.
4. Ship prepaid (COD or postage-due returns will not be accepted) via a traceable common courier (UPS, insured parcel post, FedEx, etc.) to:
Hitec RCD USA / Customer Service Center, 9320 Hazard Way, Suite D. San Diego, CA 92123



This symbol indicates that when this type of electronic device reaches the end of its service life, it cannot be disposed of with normal household waste and must be recycled. To find a recycling center near you, refer to the internet or your local phone directory for electronic waste recycling centers.

STATE OF CALIFORNIA PROPOSITION 65 WARNING

This product contains chemicals known to the State of California to cause cancer. Use caution when handling this product and avoid exposure to any electronic components or internal assemblies.

This manual is subject to change without notice.
Please refer to the Hitec RCD USA website for the latest version.

HitecRCD.com





RDX4 OPERATION MANUAL

Hitec RCD USA | 9320 Hazard Way Suite D, San Diego, CA 92123
(858) 748-6948 | www.HitecRCD.com