



LIBERTY SCALES INC

LS-7512-SS-C

USER MANUAL - WEIGHING INDICATOR



**USER
M A N U A L**



SAFETY INSTRUCTIONS



WARNING

Set, calibrate, inspect and fix the weighing indicator is prohibited by non-professional staff.

WARNING



Please make sure the weighing display well-earthing.



WARNING

The indicator is electrostatic sensitive device. Please power off during electrical connections, internal components touched by hand is prohibited, and please take the anti-static measure.



For safety operation, please follow the safety instruction..

LIST

1. Summary	-----4
1.1 Main function	-----4
1.2 Optional function	-----4
1.3 Technical parameter	-----4
1.4 Outline and installation drawing	-----5
1.5 Battery using	-----5
2. Installation	-----6
2.1 Connection between indicator and load cell	-----6
2.2 Connection of interface	-----6
3. Basic operation	-----7
3.1 Display and key instruction	-----7
3.2 Power on	-----8
3.3 Zero function	-----8
3.4 Tear function	-----9
3.5 Accumulating function	-----9
3.6 Print function	-----9
3.7 Hold function	-----10
4. Calibration	-----10
4.1 Enter and exit setting	-----10
4.2 Calibration steps	-----11
4.3 Parameter setting	-----12
5. Output data format	-----15
6. Maintenance	-----19

1. SUMMARY

This indicator is specially designed for platform scale with friendly interface, simple operation, steady feature. The Basic function includes Weigh, Peak hold, Print. Communicate, Options are accumulate, Count and animal weighing.

1.1 Main function

- » Basic weighing function: Zero Tare
- » Peak hold
- » Hold
- » Low battery remind charge controlled
- » PC communication
- » Automatically power OFF

1.2 Optional function

- » Accumulating function
- » Animal weighing
- » Printing function(with time)

1.3 Technical parameter

- » Stimulating voltage: +5VDC
- » A/D converting speed: 10 times/sec
- » Load capacity: It can connect 4 pcs 350Ω load cell at most
- » Resolution: 3000e
- » Interval: 1/2/5/10/20/50
- » Display: 6-digits LED, word height: 20.3mm
- » Key: ON/OFF TOTAL TARE ZERO SET
- » Interface: RS232C Baud rate optional
1200/2400/4800/9600
- » Ambient temperature: -10~40°C
- » Optional power: 6V/4Ah rechargeable battery;9VDC adaptor

1.4 Outline and installation picture:

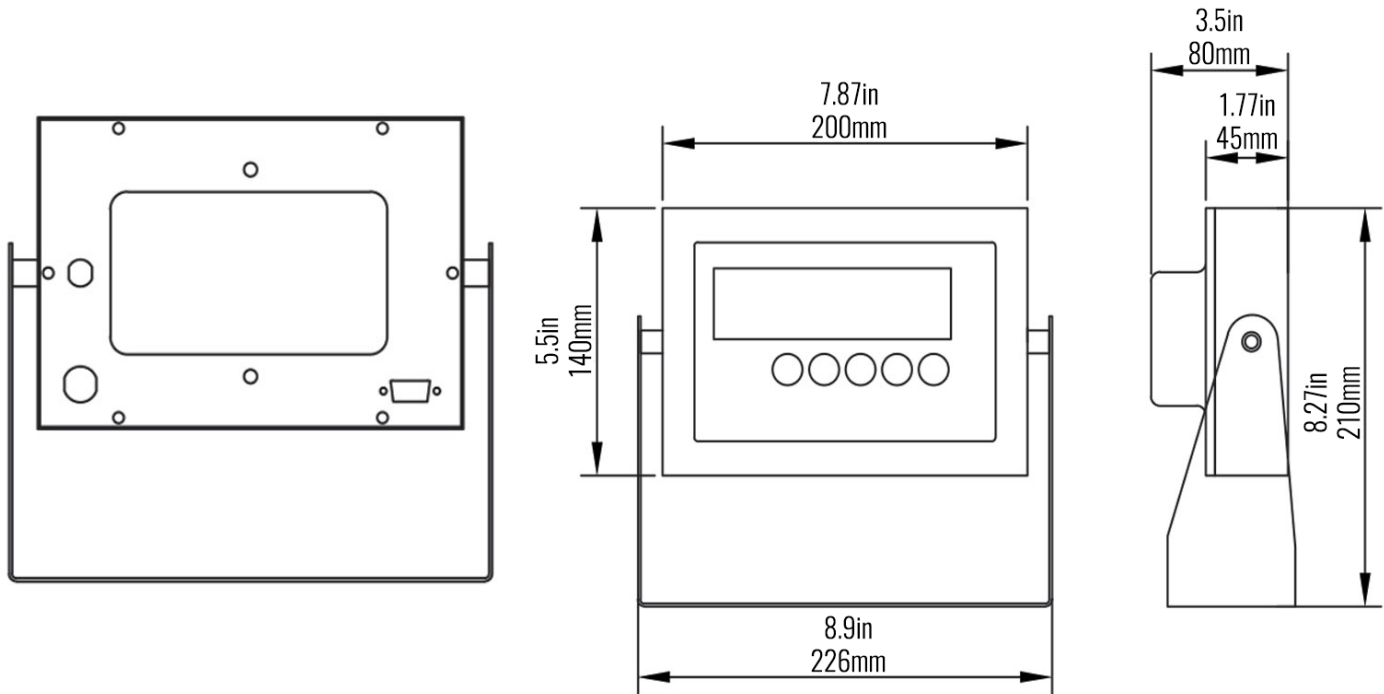

1.5 Battery:

1. when you use the internal battery first time, you should charge the battery 10-12 hours, to prevent low voltage resulted from self leakage of battery.
2. when the red battery light is on and flashes, it means low battery You should charge battery in time.
3. Charge time: 10-12 hours And it works 45 hours
4. When the battery light turns green, it means fully charged
5. If you don't use the battery long time, take out the battery to protect t the indicator from battery leakage
6. In order to keep the battery in best using condition, it is suggest that you fully discharge the battery every month, the method is that using the indicator till it is automatically power off.

2. INSTALLATION & CALIBRATION

2.1 Connection indicator with loadcell:

Indicator can connect four pcs 350Ω load cell at most, both four and six wire load cell are OK. To make it simple, we use quick disconnect or standard plug. As below:

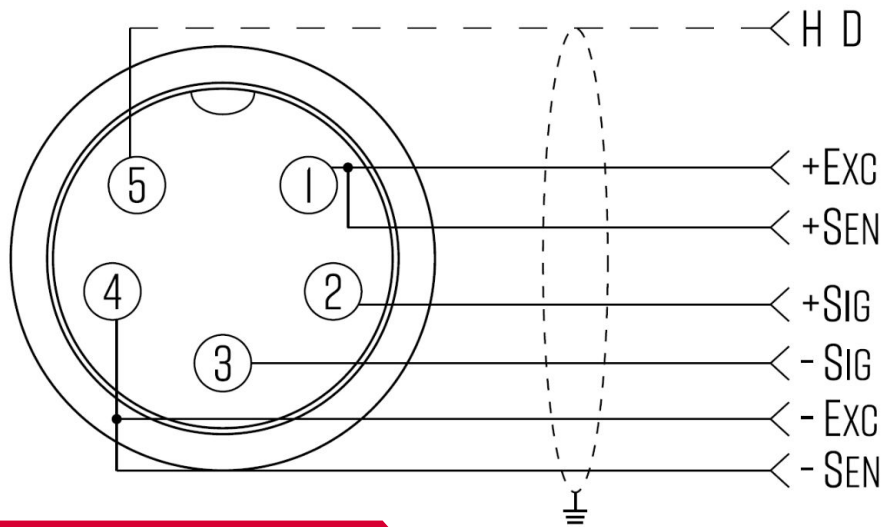

2.2 Connection of interface

RS232 communication interface use 3 cores quick connector.

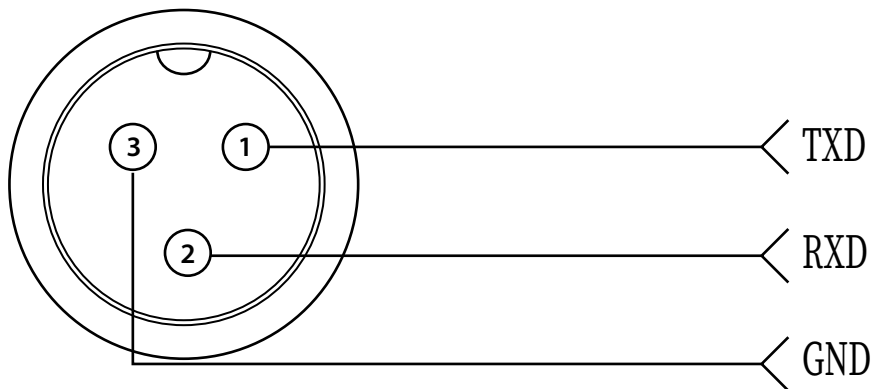

RS232 communication interface connection.

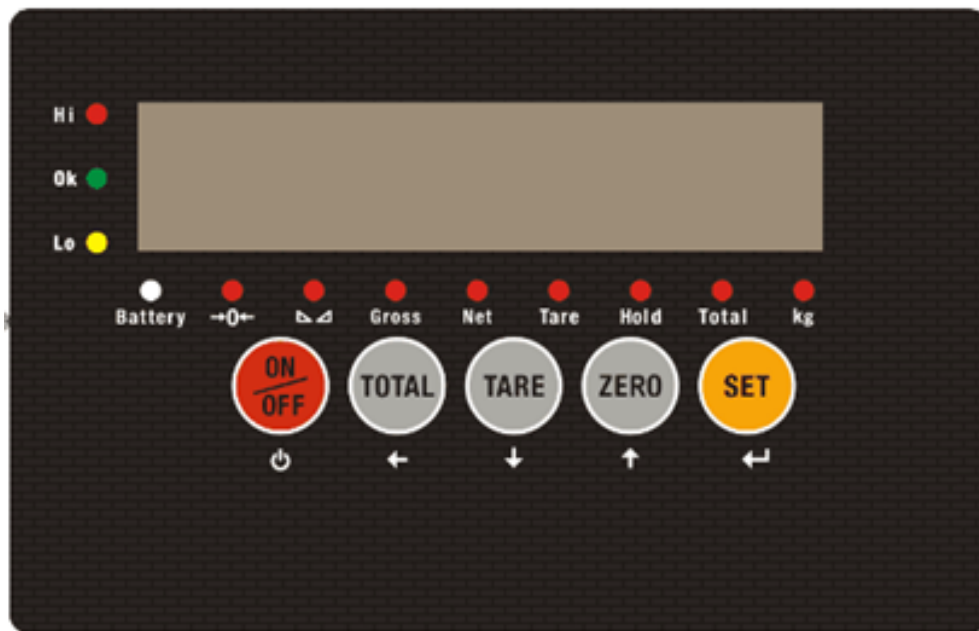

3. BASIC OPERATION

3.1 Key and display



Key name	Key function
SET	Work together with zero, tare, on/off to perform all operations.
ZERO	<ol style="list-style-type: none"> 1. Clear weight within zero range 2. Work together with SET to perform Hold and animal-weighing operation.
TARE	<ol style="list-style-type: none"> 1. At Gross mode, tare the loaded weight 2. At Net mode, display gross weight after deduct tare
TOTAL	Work together with SET perform accumulating operation
ON/OFF	<ol style="list-style-type: none"> 1. Press it for 2 seconds to power on or power off 2. Work together with "SET" to enter calibration and function setting.

Weighing indicator display instructions

LED display	Instructions
	Weighing data display
Total	Accumulating
Hold	Hold weighing data
Tare	Display tare weight
Net	Display net weight
Gross	Display gross weight
	Display data keep still
	Zero, indicating zero weight
Battery	Using battery
Hi	Over setting weight
OK	Within setting weight
Lo	Below setting weight
°	Decimal point

3.2 Power On

Power on and indicator perform self-checking and go to weighing mode.

3.3 Zero Setting

Within zero range, press “zero”, indicator weighing is cleared. When Indicator is not stable, zero is unworkable.

3.4 TARE



Press , take the loaded weight as tare, display net weight, Net weight is zero. "tare" "net" status light is on.

At the Tare mode, Press , clear the tare, display gross weight.

Note: unstable and display negative, the tare operation is invalid

3.5 TOTAL

Accumulation operation

At Zero mode, load weight till stable, Press  go to accumulating Mode, "total" light on, display "n001", and then display loaded weight; unload weight, back to zero, load weight again till stable. Press , display "n002"



Then display the loaded weight. Repeat it maximum 999 times.

Check the total weight operation:

Press  and hold it then press  At the same time, display "n**", (accumulating times) then display total weight.

There are 8 data totally. It shows the first 4 digital. then the last 4 digital For example, the first 4 digital is "0012", the last 4 digital is "34,56" It means the actual weight is "1234.56"

At TOTAL (accumulate) mode, Press  display "clr n", it means don't clear the total Weight, Press  exit it; if clear total weight,

Press "clr  n" change to "clr y" it means clear total weight display. Press  to clear the the total weight and exit accumulating mode.

3.6 Print Functions

When the data is stable, connection with printer, it will be printed after press "set" 1 second.

Note: print the gross weight when at tare mode, if the net weight is zero. Can not print.

3.7 Hold Functions

There are two different hold function. Peak hold function and data Hold function. And the setting is different accordingly.

C11=1 Peak hold C11=2 Data hold C11=0 no hold function

Peak-hold: display the maximum weight. At weighing mode, Press 



still, then press , display the “lock” weight. “hold”

Light is on. At that time, you load or unload stuff, the weight keep still

Data hold: display the “lock” weight. Press 

still, then press , display the “lock” weight. “hold”

Light is on. At that time, you load or unload weight, the weight keep still

At “hold” mode, Press  hold it and then press  to exit hold mode. “hold” light is off.



4. Calibration and Parameter Settings

4.1 Enter setting

There have two methods to enter the setting menu:

1. when the “span” is not pressed down,

Press  still and then press  enter C08-C39 setting.

2. Take out the sealing screw on the back of indicator, then press  down the “span” Press  still and then press  enter C01-C39 setting.

The key functions in setting:

 Enter

 Up

 Down

 Left

 Power switch. exit setting

4.2. Step of calibration operation:

According to the second method which can enter setting menu, C01-C39

Step	Methods of Operation	Display	Remarks
1.		[C01]	After you enter to calibration mode, it display [C01]
2.	press ←	[C1 1]	Weight unit option:1=kg
3.	press ← press ← press ↑ Or ↓	[C02] [C02 0] [C02 2]	Set decimal digits option:0/1/2/3/4 Select decimal digit example:two decimal point:[C02 2]
4.	press ← press ← press ↑ Or ↓	[C03] [C03 1] [C03 5]	Set graduation option:1/2/5/10/20/50 Select required graduation example:graduation 5:[C03 5]
5.	press ← press ← press ↑ Or ↓ ←	[C04] [0100.00] [0100.00]	Max capacity example:max weighing 100kg: [0100.00]
6.	press ← press ← press ↑ press ←	[C05] [C05 0] [C05 1] [CAL 9] ○○○○○ [0000.00]	Zero calibration option:0=non-calibration zero 1=need calibration zero calibration zero please choose 1 and ensure scale is empty and “stable” light is on Ensure zero calibration, countdown. Till show[0.00](example for two decimal point)。

7.	press ←] press ←] press ↑] or ↓] press ←] press ↑] or ↓] press ←]	[C06] [C06 0] [C06 1] [SPAN] [0100.00] [0080.00] [CAL 9] [0080.00] [CALEnd]	Loading calibration option: 0=Non-load calibration 1= load calibration Basic on max capacity setting, add suitable weight on scale. close to the max capacity, heavier than 10% max at least. For example: the weight is 80kg As bellows: enter loading calibration, count down over, indicator shows loaded weight , loading calibration finish. If you want to set application Function parameter. Press "PRINT" if you want to exit press "TOTAL"
8.	press ←] press ←] or ↓]	[C07] [07 0] [07 1]	Default parameters setting option:0=non-restore default parameters 1=restore default parameters Note: after the above parameters setting finish, please do not set default parameters often, avoid the original setting parameters lost.

4.3 Application function parameters setting chart

Functions	Setting Items	parameters setting and instruction
Warning tone	C08 warning tone	Options: 0 = close warning tone 1 = open warning tone
Automatic power off	C09 Automatic power off	Option: 0=close auto power off 10= keep still within 10 min. power off automatically 30= keep still within 30 min. power off automatically 60= keep still within 60 min. power off automatically Hold: It shows current weight value. Mainly application for animal weighing.
Power saving setting	C10 Power saving setting power off	Option: 0= close power saving setting 3= keep still within 3 min. stop display 5= keep still within 5 min. stop display
Hold function	C11 Hold mode	Option: 0=close hold function 1=Peak hold /2=Data Hold Instruction: Peak: It shows the max. data, mainly application for materials testing, such as tension and pulling force. Hold: It shows current weight value. Mainly application for animal weighing.

	C12 value	
Upper/lower limit alarm	C13 Upper limit alarm value	At setting function mode, after directly enter C15,indicator will show inner code
	C14 Lower limit alarm value value	
Inner Code display	C15 Check inner code value	At setting function mode, after directly enter C15,indicator will show inner code
Date and time	C16 Date value	At setting function mode, after directly enter C15,indicator will show inner code
	C17 Time value	At setting function mode, after directly enter C15,indicator will show inner code
Communication setting	C18 Serial interface data output method	option:0= Close serial interface data output 1= Continuous sending, connect big display 2=print method, connect printer. 3= Command request method , connect computer. 4=PC continues to sending format, connect computer.
	C19 Baud rate value	At setting function mode, after directly enter C15,indicator will show inner code
Zero range	C20 Manually zero range value	At setting function mode, after directly enter C15,indicator will show inner code
	C21 Initial zero range value	At setting function mode, after directly enter C15,indicator will show inner code
		5=±5% max capacity 10=±10% max capacity 20=±20% max capacity

Automatic zero tracking	C22 Automatic zero tracking range	option:0.0= close automatic zero tracking 0.5=±0.5d 1.0=±1.0d 2.0=±2.0d 3.0=±3.0d 4.0=±4.0d 5.0=±5.0d remark:1.d is the set graduation 2, Automatic zero tracking range can not exceed manual zero setting range
	C23 Automatic zero tracking time	option:0= close automatic zero tracking time 1=1 second 2=2 seconds 3=3 seconds
Overload range	C24 Overload range	option:00= close overload range 01d~99d remark:d is the setting graduation (division)
Negative display	C25 Negative display	Option:0=-9d 10=10% max. capacity 20=20% max. capacity
Standstill setting	C26 Standstill time	option:0= quick 1= medium 2= slow
	C27 Standstill range	option:1=1d 2=2d 5=5d 10=10d Note: d=division
Digital filter	C28 Dynamic filter Instruction:Dynamic filter is collecting the data filter before loaded weight stable. When loaded weight easily shaking (for example animal) , you can set this filter to make weight display more stable	option:0= close dynamic filter 1=1 digital filter strength 2=2 digital filter strength 3=3 digital filter strength 4=4 digital filter strength 5=5 digital filter strength 6=6 digital filter strength Note:Pls setting dynamic filter strength carefully, the No. is bigger, more stable. if the loaded weight shake not too much. The setting is less than 3



	C29 Noise filter	option:0=close noise filter 1=1 digital filter strength 2=2 digital filter strength 3=3 digital filter strength
	C30 Print time and date	C30=0 yy.mm.dd C30=1 mm.dd.yy C30=2 dd.mm.yy C30=3 yy.mm.dd

5. OUTPUT DATA FORMAT

5.1 Computer continuous sending format

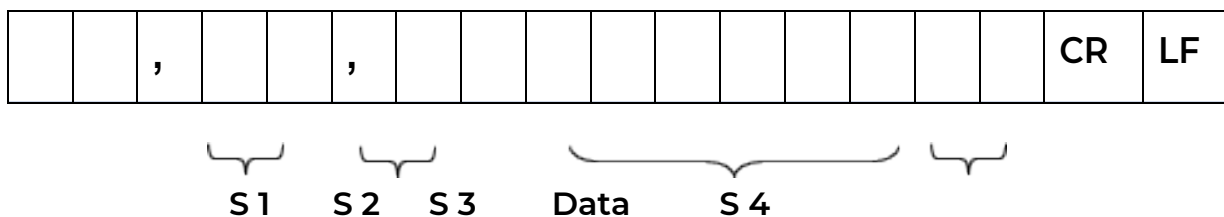

- S1:** weight status, ST= standstill, US= not standstill, OL= overload
- S2:** weight mode, GS=gross mode, NT=net mode
- S3:** weight of positive and negative, "+" or "-"
- S4:** measurement unit, "kg" or "lb"
- Data:** weight value, including decimal point
- CR:** carriage return
- LF:** line feed

5.1 Computer continuous sending format

Output continuous format																		
S T X	S W A	S W B	S W C	X	X	X	X	X	X	X	X	X	X	X	X	X	C R	C K S
1	2		3				4				5	6						

State A			
Bits0,1,2			
0	1	2	Decimal point position
1	0	0	XXXXXX0
0	1	0	XXXXXXX
1	1	0	XXXXX. X
0	0	1	XXXX. XX
1	0	1	XXX. XXX
Bits3,4			Division
0		1	X1
1		0	X2

State B	
BitsS	function
Bits0	gross=0, net=1
Bits1	symbol: positive=0, negative=1
Bits2	overload(or lower zero)=1
Bits3	dynamic=1
Bits4	unit: lb=0,kg=1
Bits5	Constant 1
Bits6	Constant0

State C			
Bit2	Bit1	Bit0	unit
0	0	0	Kgorlb
0	0	1	g
0	1	0	t
Bit3			printing=1
Bit4			Extend display=1
Bit5			Constant1
Bit6			Constant0



5.3 Serial interface reception command

RS232COM serial interface can receive simple ASCII command. Command word and role as follows:

Command	Name	Role
T	Tare command	Tare
Z	Zero command	Zero
P	Print command	Print the weight
R	Read gross/ net weight	Reply gross/net weight

5.4 Print output format



```
Date: 19.05.17
Time: 10:33:46
Net 23.13kg
Tare 11.08kg
Gross 34.21kg
```

5.5 Print the accumulated output format

```
Date: 19.05.17
Time: 10:48:25
n001 23.09kg
n002 32.04kg
n003 27.66kg
Total: 82.79kg
```

6. Maintenance

6.1 Regular Error and maintain method

Error	Reason Instructions	Solutions
Display 	1. The loaded weight excess overload range of max. capacity 2. Wrong connection with load cell or no connection with it. 3. Load cell unworkable	1. Decrease loaded weight 2. Check load cell connection 3. Checking load cell: check input and output resistance to judge it is good or not.
Display 	1. Calibration is no good 2. Cell single line is connect a wrong line. 3. The cell is bad.	1. Check scale is resisted or not, foot is kept level or not. 2. Check load cell connection. 3. Checking load cell: check input and output resistance to judge it is good or not.
Err 1	During calibration, no input added weight or input weight exceed max capacity.	Input the correct weight
Err 2	During calibration, the added weights not enough	Added weight at least 10% of Max. capacity, Recommend the weights is 60-80% the Max. capacity
Err 3	During calibration, input single is negative.	1. Check connection is correct or not. 2. Check load cell is damaged or not. 3. Renew calibration, if still wrong. pls replace the PCB
Err 4	During calibration, single is unstable	Ensure added weight and scale is stable, start calibration
Err 5	EEPROM check error	Change PCB.

6.2 Daily maintenance

1. In order to ensure indicator display clearly and prolong use life, the indicator should not be placed directly on sunlight.
2. Load cell and indicator should be well connected , the system should have a good ground, away from strong electric field, magnetic field.
3. Do not use indicator outside in rainy, better keep it power off.
4. Power off firstly while plug and unplug

6.3 Restore default parameters:

Enter setting menu, set C07= 1,press  then press  exit saving setting, all parameters will be back to default setting.

Note: Pls. do not restore default parameter easily if you are not professional and have not scale calibration.

Default parameter form

Parameter	Instruction	Default value
C01	Calibration unit	1
C02	decimal digits	0
C03	Division value	1
C04	Max capacity	10000
C05	Empty scales	0
C06	Capacity calibration	0



LIBERTY SCALES INC

LS-7512-SS-C

USER MANUAL - WEIGHING INDICATOR

C07	restore the default parameters	0
C08	Warning tone	1
C09	Automatic power off	0
C10	Power saving mode	0
C11	Hold function	0
C12		0
C13	Upper limit warning	000000
C14	Lower limit warning	000000
C15	Inner code display	
C16	Date	
C17	Time	
C18	Serial interface data output method	0
C19	Serial interface Baud rate	3=9600
C20	Manual zero setting	2
C21	Initial zero setting	10
C22	Automatic zero tracking range	0.5
C23	Automatic zero tracking time	1
C24	Verload range	9
C25	Negative display range	10
C26	Standstill time	1
C27	Standstill range	2
C28	Dynamic filter	0
C29	Noisy filter	2

6.4 Packing list

Packing list

No.	Material name	Specification	Unit	Quantity
1	Weighing indicator		set	1
2	Packing bag		PCS	1
3	Accessories bag		PCS	1
4	Power supply	GB/DC9V	PCS	1
		US/DC9V	PCS	1
		UK/DC/9V	PCS	1
		EU/DC9V	PCS	1
		AU/DC9V	PCS	1
		others	PCS	1
5	User's manual		PCS	1
6	RS232	3 core quick connector	PCS	1
7	Load cell joint	5 core quick connector	PCS	1
8	AC Power supply	3 cores Φ 0.75mm	PCS	1
9	Bracket	Wall mounted bracket	PCS	1
10	Certification		PCS	1
11	Packing list		PCS	1