

Regular cleaning with mild soap on a soft cloth, followed by a clean damp cloth, then a dry cloth, will preserve the original luster and beauty of the fine finish of your Romina Furniture product.



Thank you for being one of our distinguished clients.

**Romina**<sup>®</sup> *Team*  
Furniture

Visit  
[www.rominafurniture.com](http://www.rominafurniture.com)  
for updates, special offers and more new designs.

## ASSEMBLY INSTRUCTIONS FOR YOUR 12510 PANDORA CONVERTIBLE CRIB

this picture shows how your crib  
should look like after completing assembly



- \* READ ALL INSTRUCTIONS BEFORE ASSEMBLING CRIB. KEEP INSTRUCTIONS FOR FUTURE USE.
- \* NEVER USE PLASTIC SHIPPING BAGS OR OTHER PLASTIC FILM AS MATTRESS COVERS BECAUSE THEY CAN CAUSE SUFFOCATION.
- \* INFANTS CAN SUFFOCATE IN GAPS BETWEEN CRIB SIDES AND A MATTRESS THAT IS TOO SMALL.

**WARNING:** THE PROPER USE OF THIS CRIB IS IMPORTANT FOR YOUR BABY'S SAFETY. TO KEEP YOUR BABY SECURE AND SAFE, AND TO AVOID POTENTIAL INJURY OR DEATH, CAREFULLY READ AND FAMILIARIZE YOURSELF WITH ALL WARNINGS, CAUTIONS AND INSTRUCTIONS FROM THE INSTRUCTION BOOKLET. KEEP THIS INSTRUCTION BOOKLET FOR FUTURE USE.

**IMPORTANT: PLEASE, READ ALL INSTRUCTIONS BEFORE ASSEMBLING! PLEASE, SAVE INSTRUCTIONS FOR FUTURE USE**

DO NOT THROW AWAY THIS INSTRUCTION BOOKLET

THIS CRIB CONFORMS TO APPLICABLE REGULATIONS PROMULGATED BY THE CONSUMER PRODUCT SAFETY COMMISSION

**Romina**<sup>®</sup>

4300 NORTHLAKE CT STE E, CHARLOTTE NC 28216-9958  
Phone (718) 478 5100, Fax (718) 478 5117  
[www.rominafurniture.com](http://www.rominafurniture.com)

NOTE: THE STYLE OF YOUR CRIB, MATTRESS SUPPORT OR TODDLER RAIL MAY VARY FROM WHAT IS PICTURED IN THE INSTRUCTION SHEET

**⚠️WARNING!** INFANTS CAN SUFFOCATE ON SOFT COMFORTER. NEVER PLACE ADDITIONAL PADDING UNDER AN INFANT. FAILURE TO FOLLOW THESE WARNINGS AND ASSEMBLY INSTRUCTIONS COULD RESULT IN SERIOUS INJURY OR DEATH.

## **CAUTION: ANY MATTRESS USED IN THIS CRIB SHALL BE AT LEAST 27 1/4 BY 51 5/8 IN. WITH A THICKNESS NOT EXCEEDING 6 IN.**

- TO REDUCE THE RISK OF SIDS, PEDIATRICIANS RECOMMEND HEALTHY INFANTS BE PLACED ON THEIR BACKS TO SLEEP, UNLESS OTHERWISE ADVISED BY YOUR PHYSICIAN.

### **STRANGULATION HAZARD:**

- STRINGS CAN CAUSE STRANGULATION! **DO NOT** PLACE ITEMS WITH A STRING AROUND A CHILD'S NECK, SUCH AS HOOD STRINGS OR PACIFIER CORDS. **DO NOT** SUSPEND STRINGS OVER A CRIB OR ATTACH STRINGS TO TOYS.
- TO HELP PREVENT STRANGULATION TIGHTEN ALL FASTENERS. A CHILD CAN TRAP PARTS OF THE BODY OR CLOTHING ON LOOSE FASTENERS.
- **DO NOT** PLACE CRIB NEAR WINDOW WHERE CORDS FROM BLINDS OR DRAPES MAY STRANGLE A CHILD.

### **FALL HAZARD:**

- WHEN CHILD IS ABLE TO PULL TO A STANDING POSITION, SET MATTRESS TO LOWEST POSITION AND REMOVE BUMPER PADS, LARGE TOYS AND OTHER OBJECTS THAT COULD SERVE AS STEPS FOR CLIMBING OUT.
- STOP USING CRIB WHEN CHILD BEGINS TO CLIMB OUT OR REACHES THE HEIGHT OF 35 IN. (89 CM).

- CHECK THIS PRODUCT FOR DAMAGED HARDWARE, LOOSE JOINTS, LOOSE BOLTS OR OTHER FASTENERS, MISSING PARTS, OR SHARP EDGES BEFORE AND AFTER ASSEMBLY AND FREQUENTLY DURING USE. SECURELY TIGHTEN LOOSE BOLTS AND OTHER FASTENERS. **DO NOT** USE CRIB IF ANY PARTS ARE MISSING, DAMAGED OR BROKEN. CONTACT **ROMINA FURNITURE** FOR REPLACEMENT PARTS AND INSTRUCTIONAL LITERATURE IF NEEDED. **DO NOT** SUBSTITUTE PARTS.

- IF REFINISHING, USE AN ANON-TOXIC FINISH SPECIFIED FOR CHILDREN'S PRODUCTS.

- FOLLOW WARNINGS ON ALL PRODUCTS IN A CRIB.

- READ ALL INSTRUCTIONS BEFORE ASSEMBLING CRIB. **KEEP INSTRUCTIONS FOR FUTURE USE.** A STORAGE POUCH & 2 PLASTIC TIES HAVE BEEN PROVIDED IN THE HARDWARE BAG. ATTACH POUCH TO MATTRESS SUPPORT WITH PLASTIC TIES AND STORE THE INSTRUCTIONS THERE.

- **NEVER** USE PLASTIC SHIPPING BAGS OR OTHER PLASTIC FILM AS MATTRESS COVERS BECAUSE THEY CAN CAUSE SUFFOCATION.

- INFANTS CAN SUFFOCATE IN GAPS BETWEEN CRIB SIDES AND A MATTRESS THAT IS TOO SMALL.

- **DO NOT** USE A WATER MATTRESS WITH THIS CRIB.

- BEFORE USING THIS CRIB RECHECK ALL SCREWS AND BOLTS TO BE SURE THEY ARE FASTENED SECURELY. A PERIODIC CHECK SHOULD BE MADE TO BE SURE THESE ITEMS REMAIN TIGHT.

- TO AVOID HEAD INJURY, **DO NOT** ALLOW ANY CHILD TO PLAY UNDERNEATH CRIB.

**THIS PAGE INTENTIONALLY LEFT BLANK**

# CAUTION:

\*WHEN A CHILD'S HEIGHT REACHES 35 INCHES, THE CHILD SHOULD BE PLACED IN A YOUTH OR REGULAR BED.

\*USE OF A VAPORIZER NEAR FURNITURE WILL CAUSE WOOD TO SWELL AND FINISH TO PEEL.

\*DO NOT STORE CRIB IN AREAS WHERE TEMPERATURES AND CONDITIONS ARE EXTREME, SUCH AS HOT ATTICS OR COLD DAMP BASEMENTS. BOTH OF THESE EXTREME CONDITIONS MAY CAUSE THE WOOD TO CRACK AND GLUE JOINTS TO LOOSEN RESULTING IN STRUCTURAL FAILURE.

\*SHOULD IT BECOME DESIRABLE TO REFINISH THIS CRIB IN LATER YEARS, THE MANUFACTURER WARNS THAT ANY MATERIAL USED SHOULD BE NON-TOXIC. REGULAR CLEANING WITH MILD SOAP ON A SOFT CLOTH, FOLLOWED BY A CLEAN DAMP CLOTH, THEN A DRY CLOTH, WILL PRESERVE THE ORIGINAL LUSTER AND BEAUTY OF THIS FINE FINISH.

\*THIS CRIB IS NOT EQUIPPED TO HANDLE THE EXCESS WEIGHT OF A CRIB WATER MATTRESS.

\*LIFT SLIGHTLY WHEN MOVING ON CARPETING TO PREVENT LEG BREAKAGE.

**ENSURE A SAFE ENVIRONMENT FOR THE CHILD BY CHECKING REGULARLY THAT EVERY COMPONENT IS PROPERLY AND SECURELY IN PLACE, BEFORE PLACING THE CHILD IN THE CRIB.**

## **MAINTENANCE OF YOUR ROMINA CONVERTIBLE CRIB:**

AFTER YOU FINISH ASSEMBLING YOUR CRIB, BE SURE THAT ALL BOLTS HAVE BEEN TIGHTENED SECURELY. YOU MUST CHECK ALL BOLTS PERIODICALLY AND RE-TIGHTEN AS NECESSARY. PERIODICALLY INSPECT CRIB FOR DAMAGED HARDWARE, LOOSE JOINTS OR SPLINTERED EDGES.

**DO NOT USE CRIB IF PARTS ARE DAMAGED OR BROKEN!** CONTACT YOUR DEALER OR **ROMINA FURNITURE** FOR ASSISTANCE AND REPLACEMENT PARTS. PLEASE BE SURE TO HAVE YOUR MODEL CODE WRITTEN DOWN BEFORE YOU MAKE CONTACT. THE MODEL CODE CAN BE FOUND ON A WHITE LABEL LOCATED ON THE INSIDE OF YOUR CRIB ON THE SIDE PANEL.

**NEVER SUBSTITUTE PARTS OR MAKE ALTERATIONS TO YOUR CRIB!**

**Note:** The letters which identifies a part are the initials of the respective part name (such method is employed to facilitate parts recognition between the drawings and the parts list).

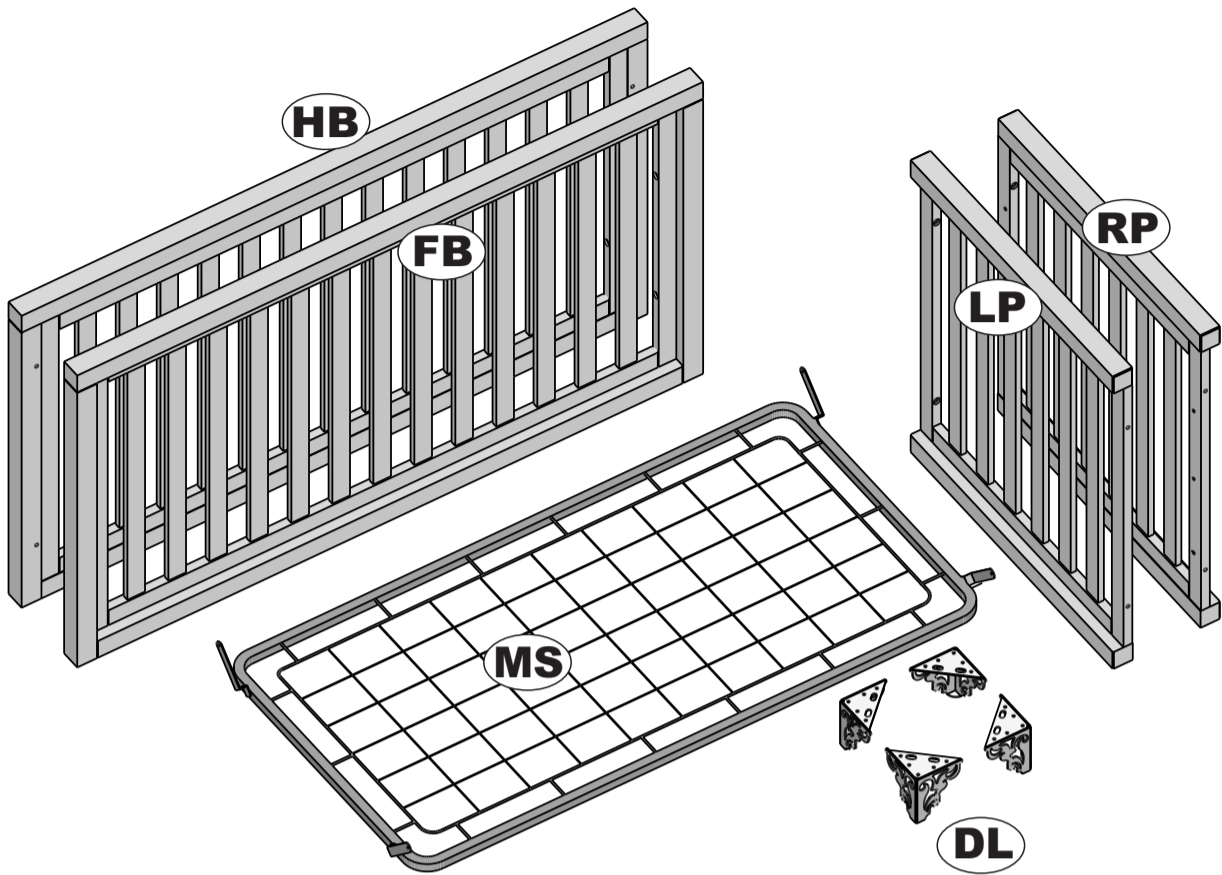

# 12510 BOX CONTENT

Please locate and confirm that you have the following parts:

- HB. headboard = 1
- FB. footboard = 1
- LP. left panel = 1
- RP. right panel = 1
- MS. mattress support = 1
- DL. decorative leg = 4

one bag of hardware with the following:

1. Allen wrench = 1
2. one storage pouch and two plastic ties
3. Allen bolt (16mm - 0 2/3") = 16
4. Allen bolt (50mm - 2") = 8
5. "internal star" lock washer = 24

**Required tools:** Allen wrench (supplied)

**CAUTION:** Do not use a power screwdriver which can cause screws to break or strip.

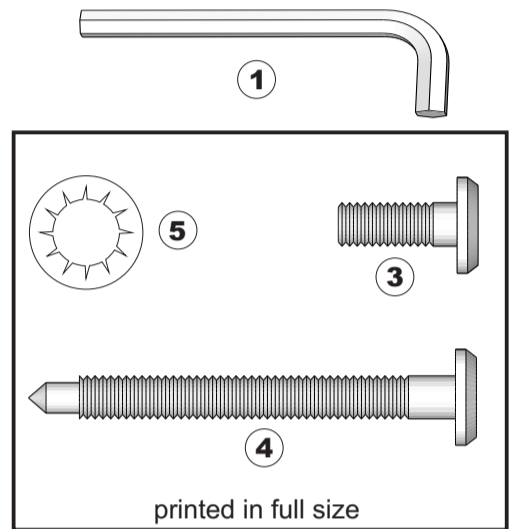

**NOTE:** THE STYLE OF YOUR CRIB, METALLIC BRACKETS OR MATTRESS SUPPORT MAY VARY FROM WHAT IS PICTURED IN THE INSTRUCTION SHEET

**Note:** The item number of your product is located on the inner side of the left panel, on a black and white label. Please, refer to this number in the event that you need to call **ROMINA FURNITURE** or your local distributor. Thank you.

**Note:** During the assembly process whenever using screws or bolts, check each by placing the screw / bolt on the hardware diagram which is drawn in actual size. Be sure to use the proper size and shape specified in the instructions. Be sure to **COMPLETELY TIGHTEN** the screws / bolts when you are asked to do this.

## GENERAL FURNITURE CARE TIPS

- Wood, like any natural material is likely to present variations of grain and texture which will result in slight color variations or richness in the finish. These differences make each Romina Furniture item as beautiful and unique as you and your baby are.
- To preserve the initial appearance and functionality of your furniture, it is recommended that all furniture items be used in accordance with their intended design.
- Special water-based finishes are used to make this furniture safe for your baby. These finishes may be more delicate than those used on adult furniture thus requiring careful maintenance.
- Constant rubbing or mechanical interaction with sharp/hard objects such as belt buckles, jeans' zippers or buttons will likely damage the finish on your furniture. When placing or retrieving items onto the furniture, always set them down and pick them up, do not "slide" them. Items placed onto the horizontal surfaces must be moved/rotated to prevent discoloration in the finish.
- Exposure to extreme variations of environmental conditions such as humidity and temperature can affect the finish quality due to wood sudden expansion or shrinkage. It is recommended that the room temperature be maintained in between 65 and 75 degrees Fahrenheit and a relative humidity of 35 – 40 %. Do not place items which are too hot or too cold directly onto the finished surfaces!
- Use caution when using a humidifier or vaporizer. Excessive moisture is harmful to the furniture causing the finish to peel and the wood to warp.
- Wipe up spills promptly. If water or other liquids stay in contact with the furniture for a long period of time, they can cause the finish to turn white or discolor. Alcohol or solvent containing substances or materials will permanently damage the finish.
- In general, furniture should not be placed in front or too close to air-conditioning outlets, fireplaces, heaters or humidifiers. Direct sunlight and ultraviolet rays will cause colors to fade, affect the luster and smoothness of the finish and in most cases may cause hairline cracks in the finish. White finishes will yellow naturally over time; exposure to direct sunlight will accelerate this natural process. Please note that all wood essences will darken over time along with the natural aging process which is not considered to be a quality defect.
- To clean the furniture, use a damp cloth immediately followed by wiping with a dry cloth. Do not allow water to stay in contact with the finish as it will damage the finish.
- If you need to put your furniture into storage for any period of time, avoid placing it in damp basements or hot attics. Air flow around and under the furniture should be allowed. Do not place furniture too close to walls, do not stack anything on it and do not cover it entirely.
- When using a vinyl changing pad or similar plastic accessories, make sure to use a fabric felt underneath. Certain plastics have ingredients that can react with and damage the finish. It is recommended to rotate the changing pad's position frequently to avoid finish discoloration.

**Romina**®

# THE TODDLER RAIL OPTION OF YOUR 12510 CONVERTIBLE CRIB

(THE TODDLER RAIL IS SOLD SEPARATELY)

**NOTE:** YOUR 12510 CONVERTIBLE CRIB CAN CONVERT INTO A TODDLER BED WITH THE PURCHASE OF ROMINA FURNITURE ITEM CODE **TR 12500 (TODDLER RAIL)**. ASSEMBLY INSTRUCTIONS FOR THE TODDLER BED OPTION CAN BE FOUND INSIDE OF **TR** PACKAGE. PLEASE, CONTACT ROMINA FURNITURE OR YOUR LOCAL DISTRIBUTOR FOR MORE INFORMATION.

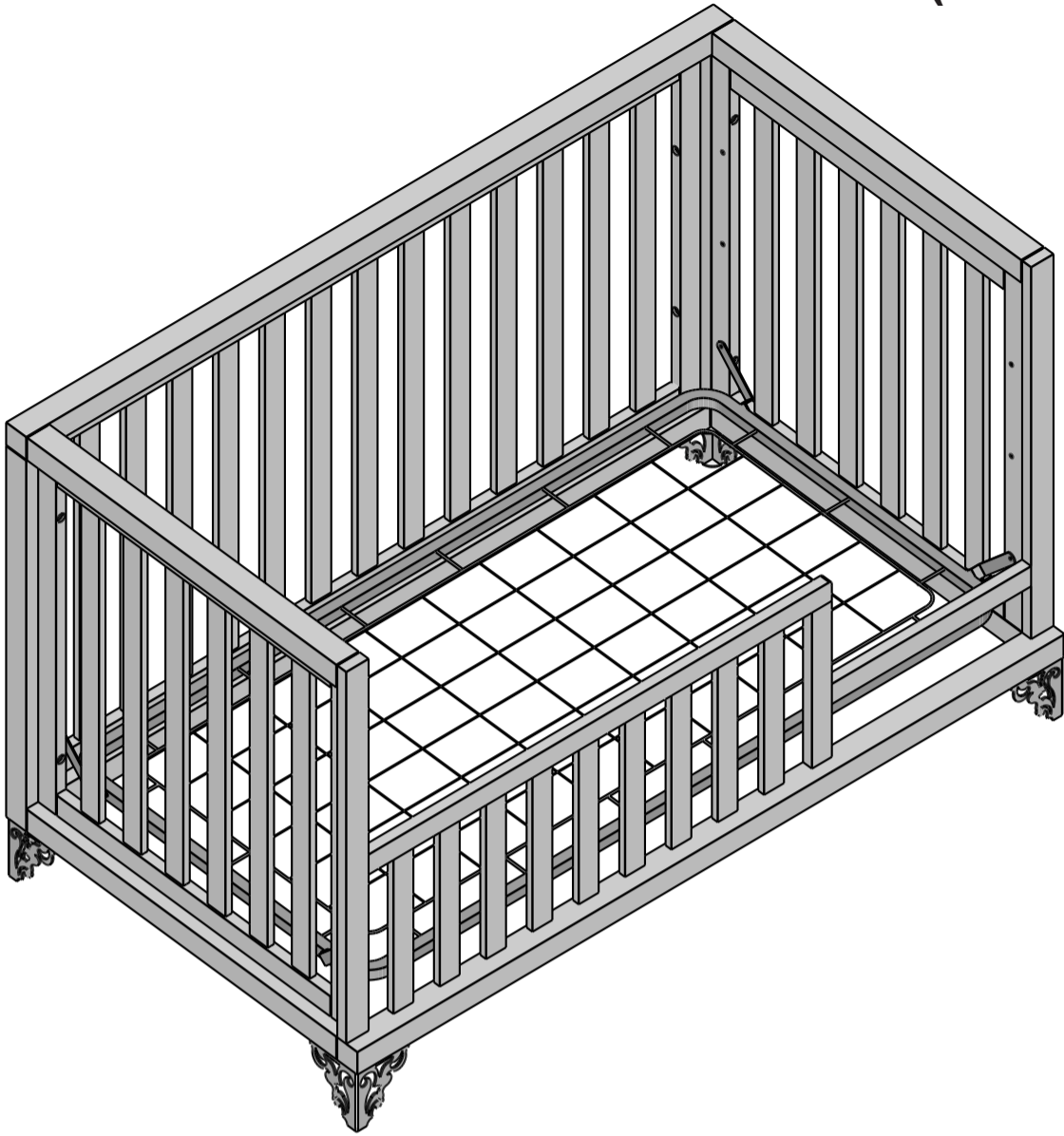

## STEP 1 (For all ROMINA cribs - one adult is required to complete this step)

Take the mattress support (**MS**) of your crib and position it so the springs of the mesh will face upside and the metallic pins found nearby the metallic brackets will face downside (please see **FIGURE 1A**).

**The proper orientation of the mattress support is very important for the correct assembling and usage of the crib**

Rotate all the metallic brackets until they are stopped by the metallic pins (please see **FIGURE 1B**).

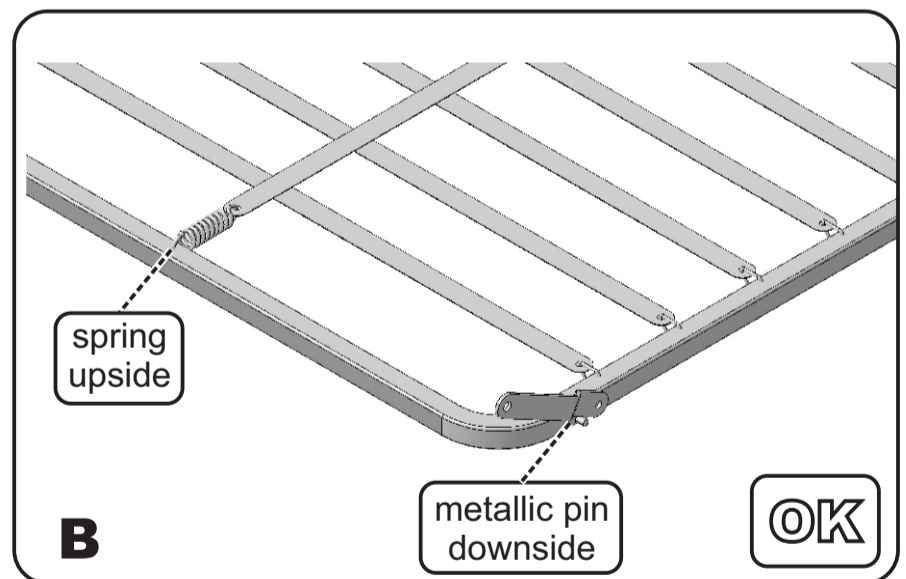
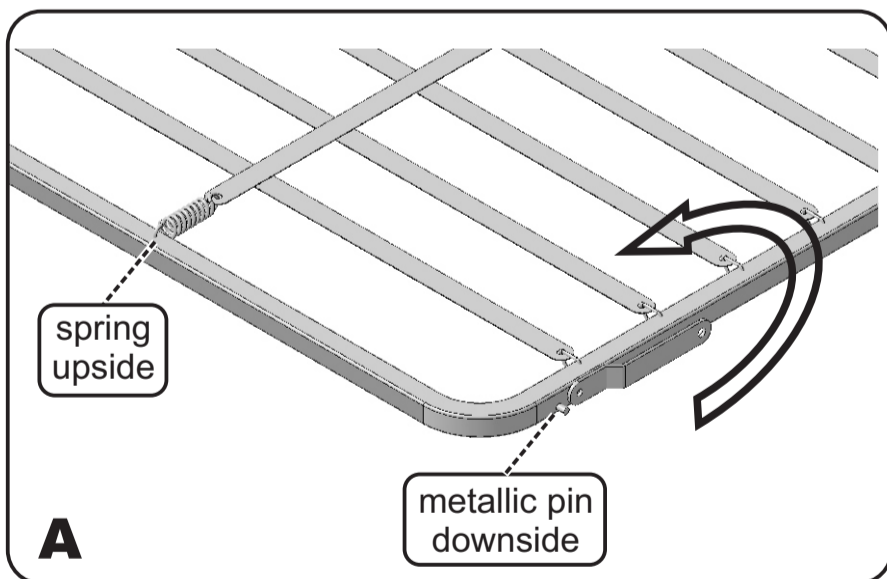
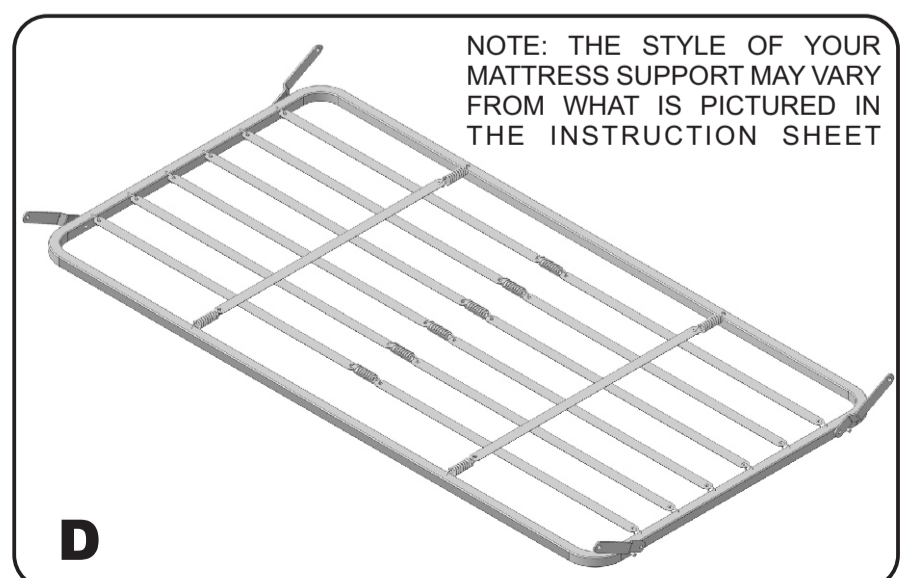
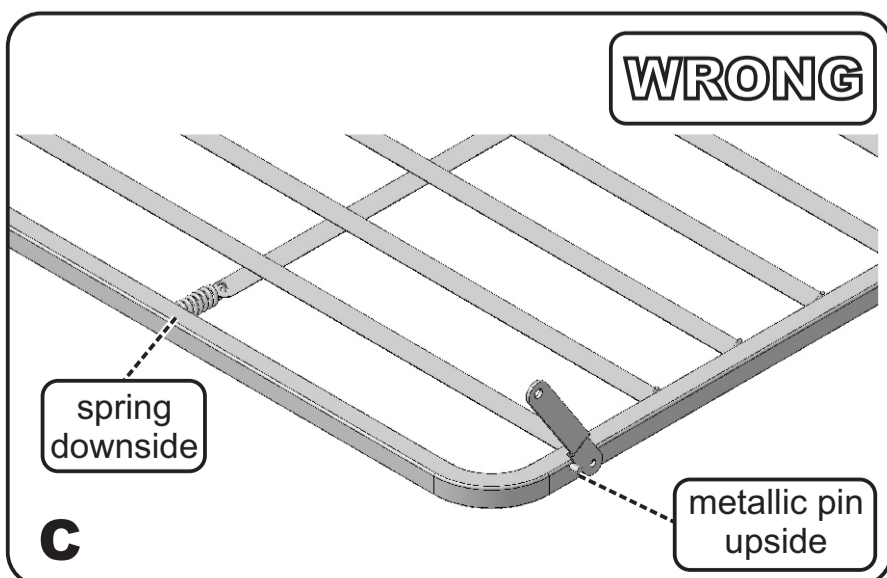

FIGURE 1



## REQUIRED

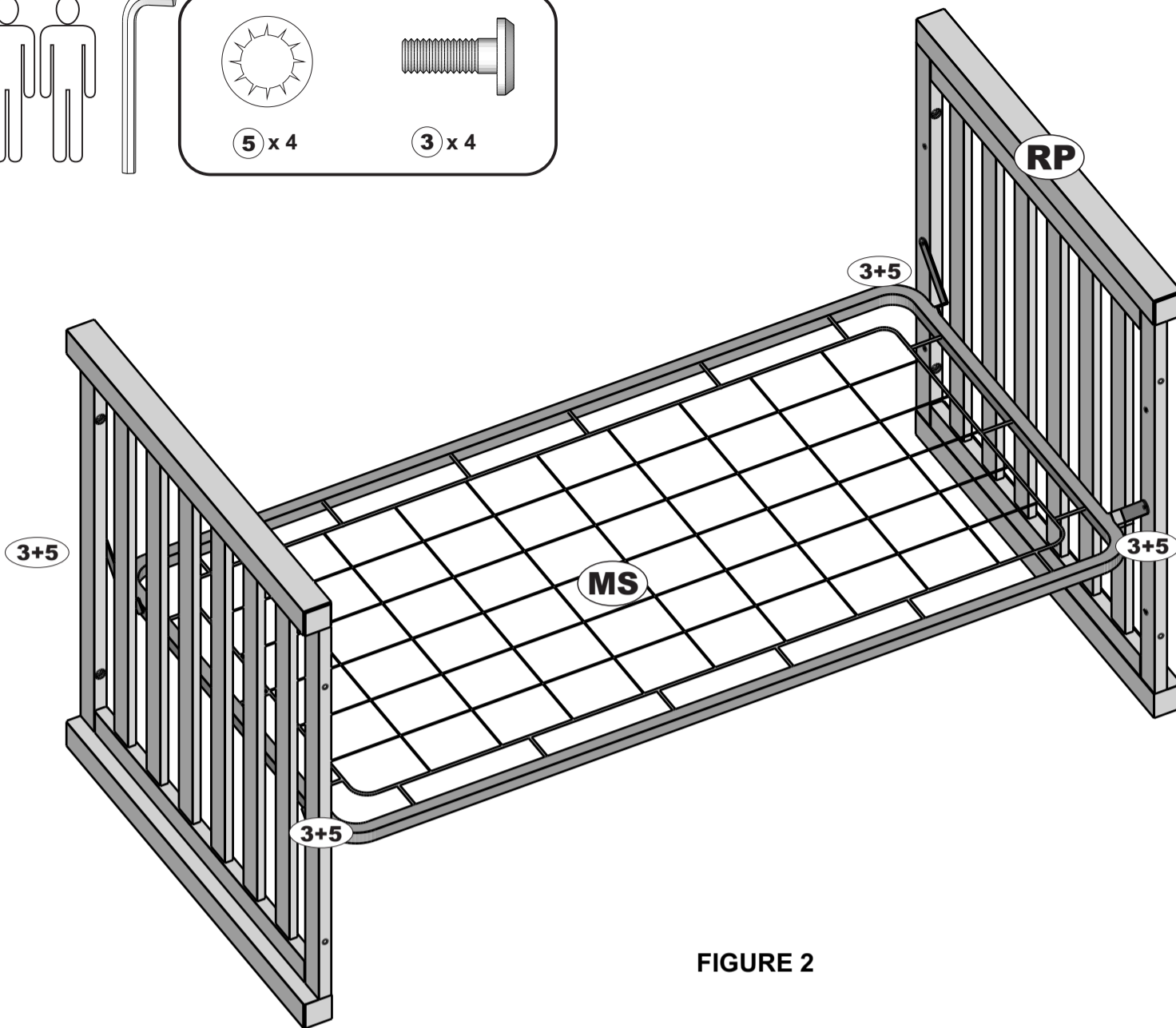
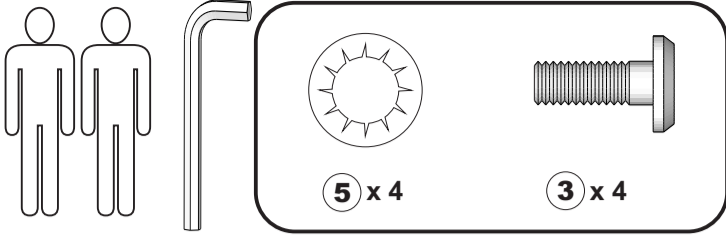

FIGURE 2

### STEP 2 (Two adults are required to complete this step)

Attach mattress support (MS) to the left and right panels (LP & RP) using four Allen bolts (4), four washers (5) and the Allen key. Take care to insert the washer between the bolt. Use soft surface during installation (blanket or carpet) to avoid damage to crib's finish.

Do not completely tighten the bolts at this step, you will be asked to do this in step 4.

NOTE: THE STYLE OF YOUR CRIB, METALLIC BRACKETS OR MATTRESS SUPPORT MAY VARY FROM WHAT IS PICTURED IN THE INSTRUCTION SHEET

## THE FULL SIZE BED OPTION OF YOUR 12530 CONVERTIBLE CRIB (THE CONVERSION KIT IS SOLD SEPARATELY)

YOUR 12530 CONVERTIBLE CRIB CAN CONVERT INTO A FULL SIZE BED WITH THE PURCHASE OF ROMINA FURNITURE ITEM CODE **CKC 12510** (CONVERSION KIT FOR CRIBS). ASSEMBLY INSTRUCTIONS FOR THE FULL SIZE BED OPTION CAN BE FOUND INSIDE OF **CKC** PACKAGE. PLEASE, CONTACT ROMINA FURNITURE OR YOUR LOCAL DISTRIBUTOR FOR MORE INFORMATION.

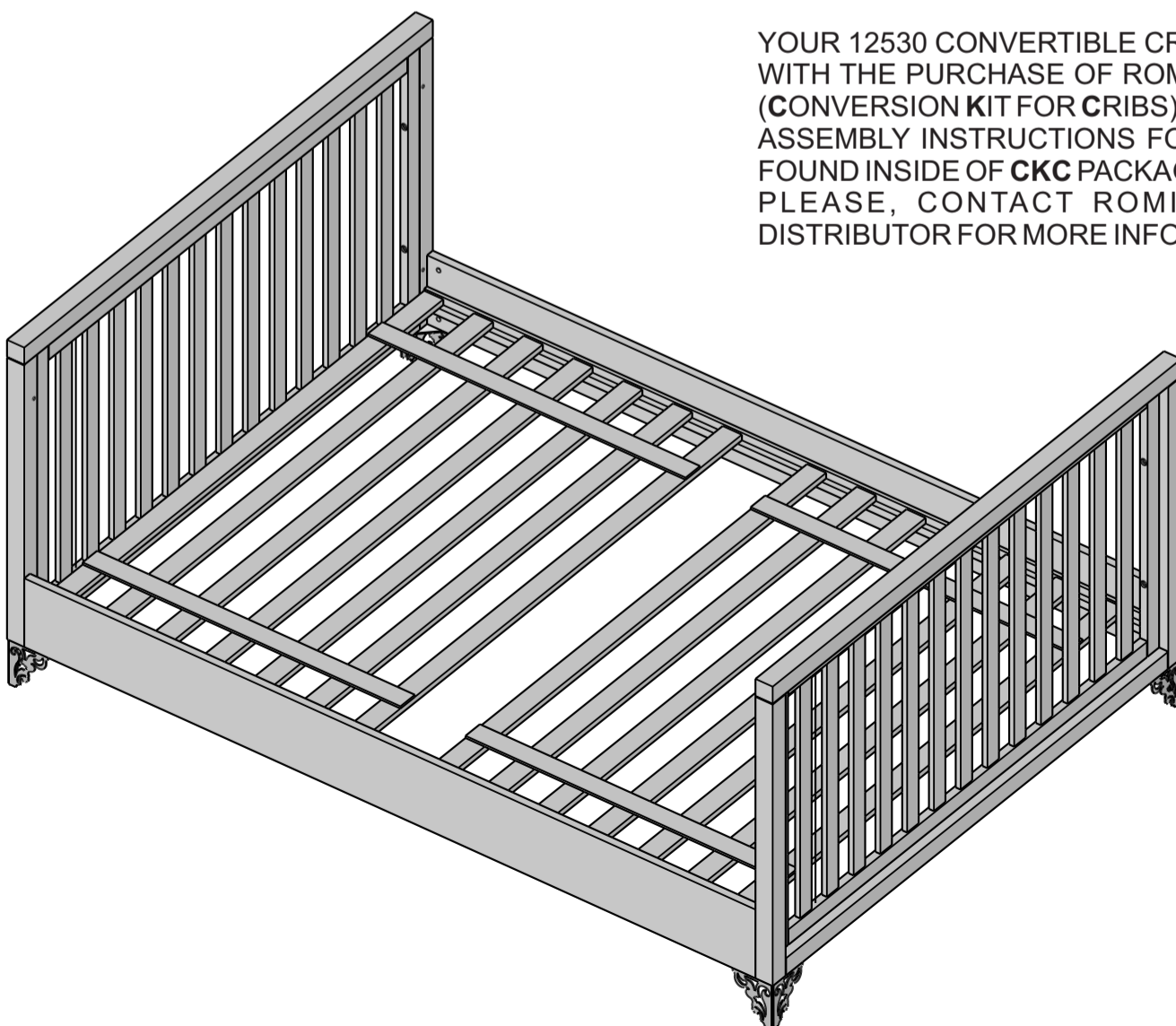

**WARNING:** TO KEEP YOUR BABY SECURE AND SAFE, AND TO AVOID POTENTIAL INJURY OR DEATH, IT'S **VERY IMPORTANT** TO **COMPLETELY TIGHTEN** ALL 4 BOLTS LISTED IN "ADJUSTING THE HEIGHT OF YOUR MATTRESS SUPPORT" PROCEDURE.

**REQUIRED**

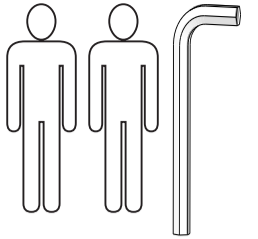
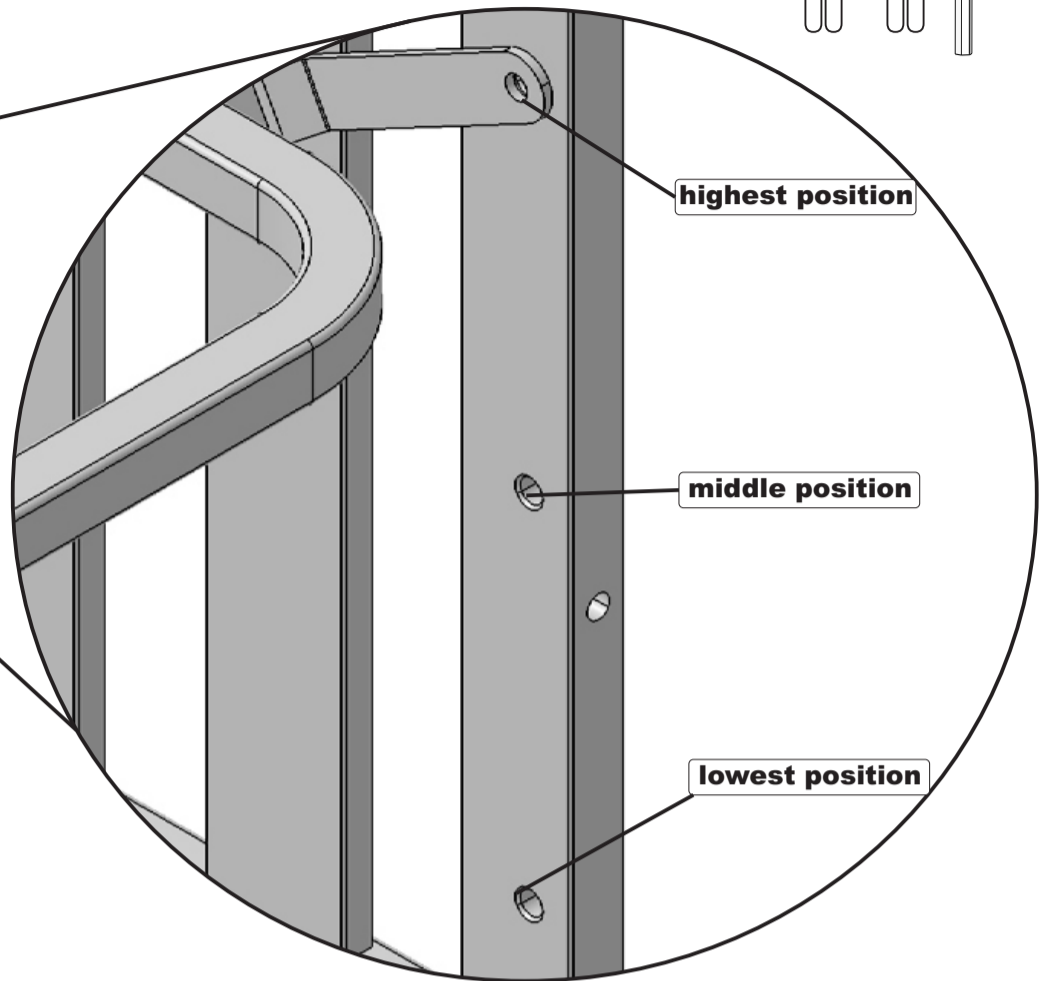

FIGURE 6



**ADJUSTING THE HEIGHT OF YOUR MATTRESS SUPPORT**

To adjust the vertical position of your mattress support you must remove the mattress support from the crib (please see **STEP 2**) and re-attach it to the lateral panels of the crib according to the desired height (please see **FIGURE 6**). Then, you must completely tighten all bolts.

**WARNING:** TO KEEP YOUR BABY SECURE AND SAFE, AND TO AVOID POTENTIAL INJURY OR DEATH, IT'S **VERY IMPORTANT** TO **COMPLETELY TIGHTEN** ALL 4 BOLTS AND WASHERS AFTER YOU HAVE ADJUSTED THE HEIGHT OF YOUR MATTRESS SUPPORT.

**NOTE:** THE STYLE OF YOUR CRIB OR OF YOUR MATTRESS SUPPORT MAY VARY FROM WHAT IS PICTURED IN THE INSTRUCTION SHEET

**REQUIRED**

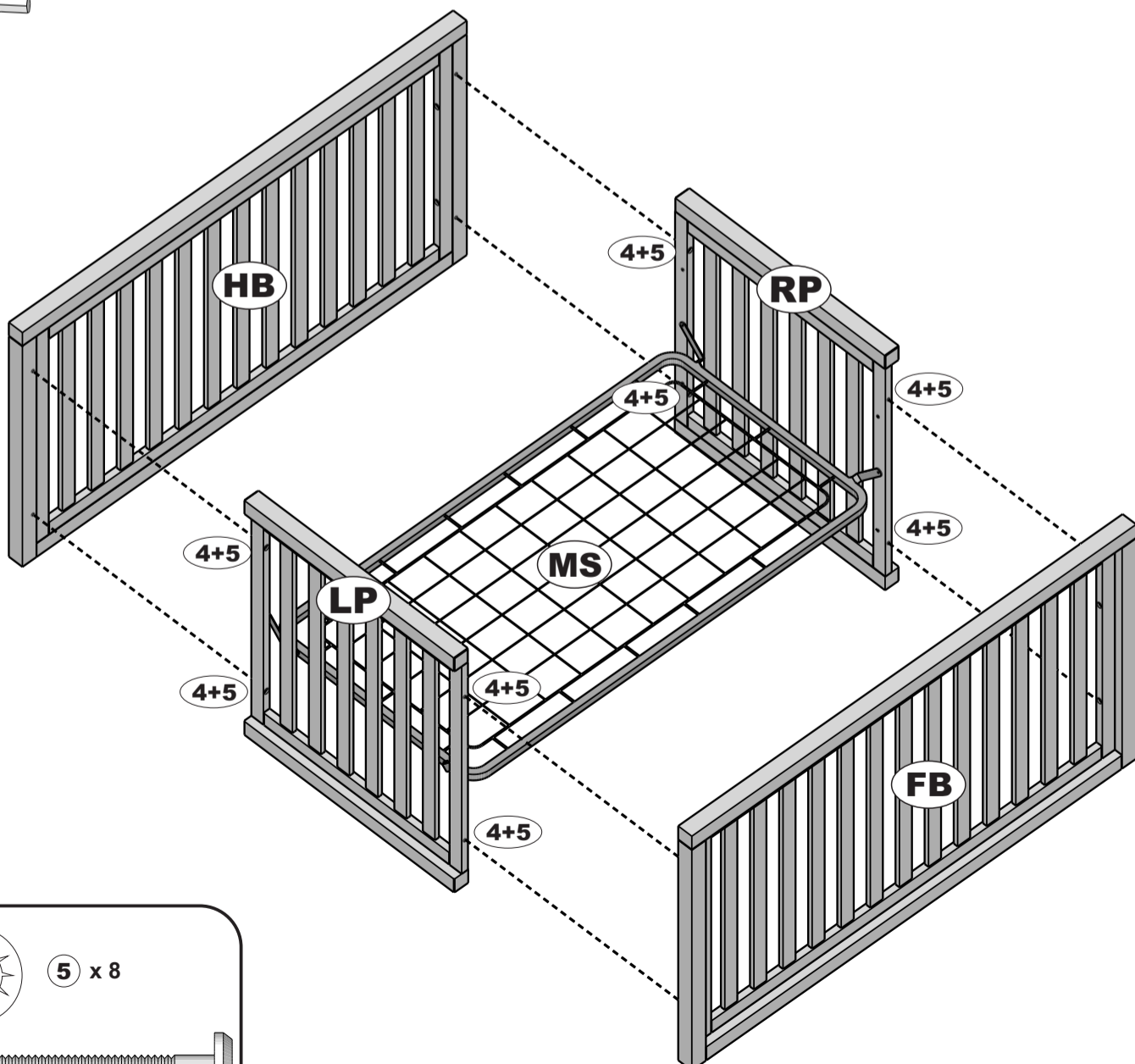
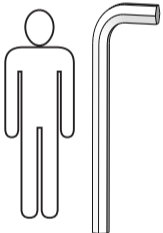
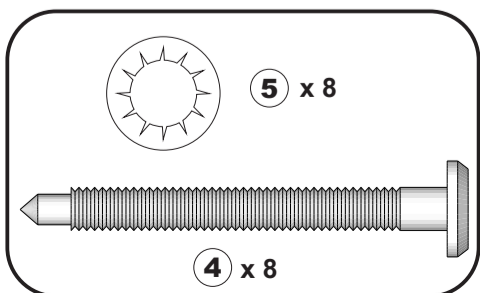

FIGURE 3



**STEP 3 (One adult is required to complete this step)**

Attach the footboard (**FB**) and headboard (**HB**) to the left and right panels (**LP & RP**) using eight Allen bolts (**4**), eight washers (**5**) and the Allen key. Take care to insert the washer between the bolt and the vertical post of the panel!

**Completely tighten** all 8 Allen bolts (**4+5**) used to attach the footboard and headboard.

**REMINDER**

You have to completely tighten 8 Allen bolts, distributed as following:  
 - 4 bolts (**4+5**) in the footboard.  
 - 4 bolts (**4+5**) in the headboard.

**WARNING:** TO KEEP YOUR BABY SECURE AND SAFE, AND TO AVOID POTENTIAL INJURY OR DEATH, IT'S **VERY IMPORTANT** TO **COMPLETELY TIGHTEN** ALL 8 BOLTS.

**NOTE:** THE STYLE OF YOUR CRIB OR OF YOUR MATTRESS SUPPORT MAY VARY FROM WHAT IS PICTURED IN THE INSTRUCTION SHEET

**REQUIRED**

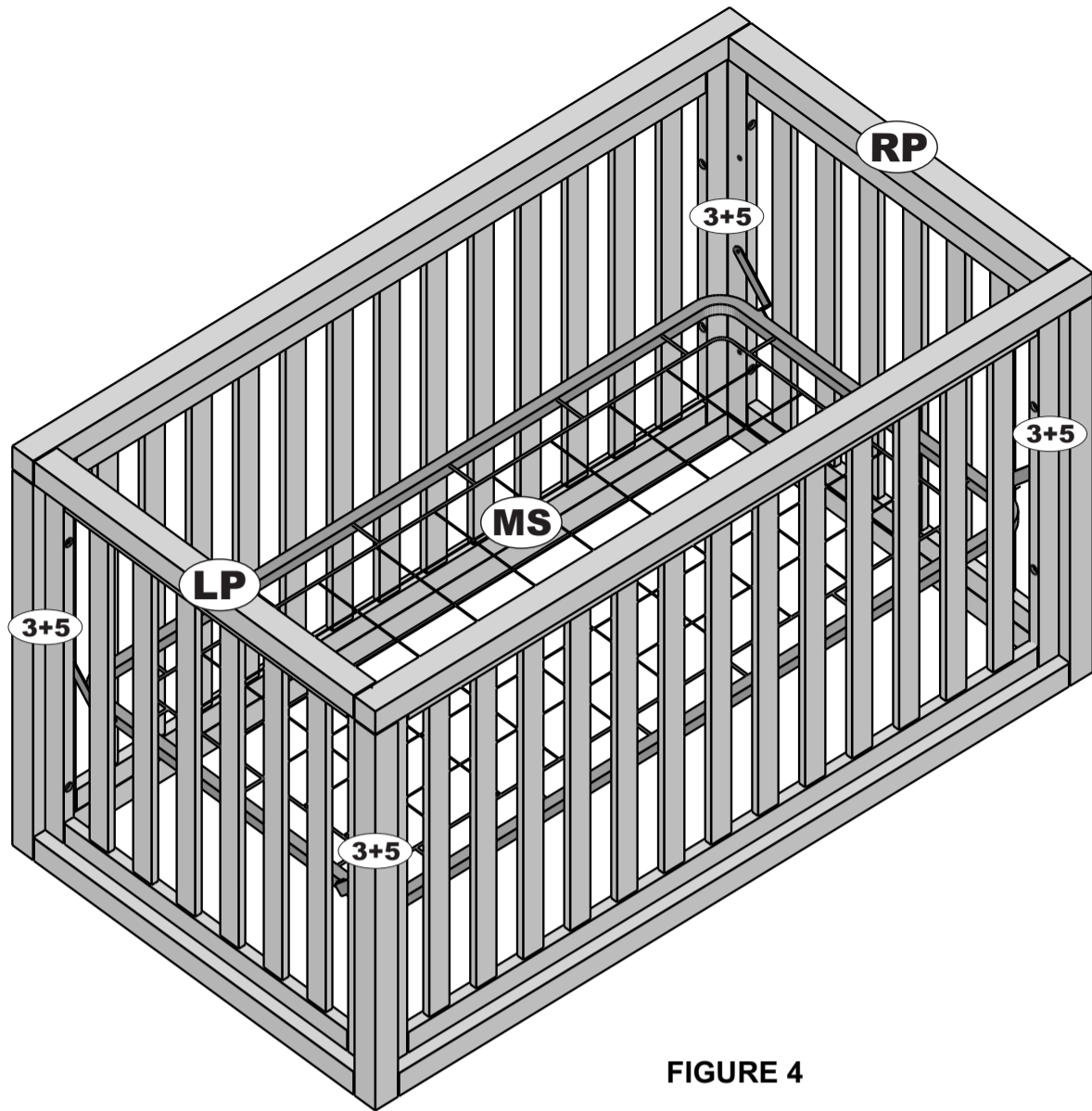
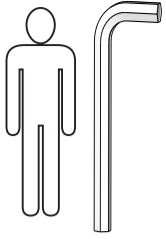

**FIGURE 4**

**STEP 4 (One adult is required to complete this step)**

**Completely tighten** all 4 Allen bolts (3+5) used to attach the mattress support.

**REMINDER**

**You have to completely tighten 4 Allen bolts, distributed as following:**  
 - 4 bolts (3+5) in the left and right panels (LP & RP).

**WARNING:** TO KEEP YOUR BABY SECURE AND SAFE, AND TO AVOID POTENTIAL INJURY OR DEATH, IT'S **VERY IMPORTANT TO COMPLETELY TIGHTEN ALL 4 BOLTS.**

**NOTE:** THE STYLE OF YOUR CRIB, METALLIC BRACKETS OR MATTRESS SUPPORT MAY VARY FROM WHAT IS PICTURED IN THE INSTRUCTION SHEET

**REQUIRED**

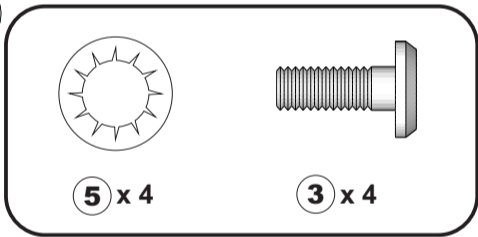
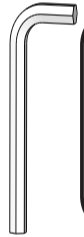
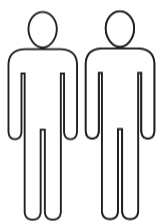

5 x 4

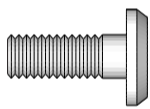

3 x 4

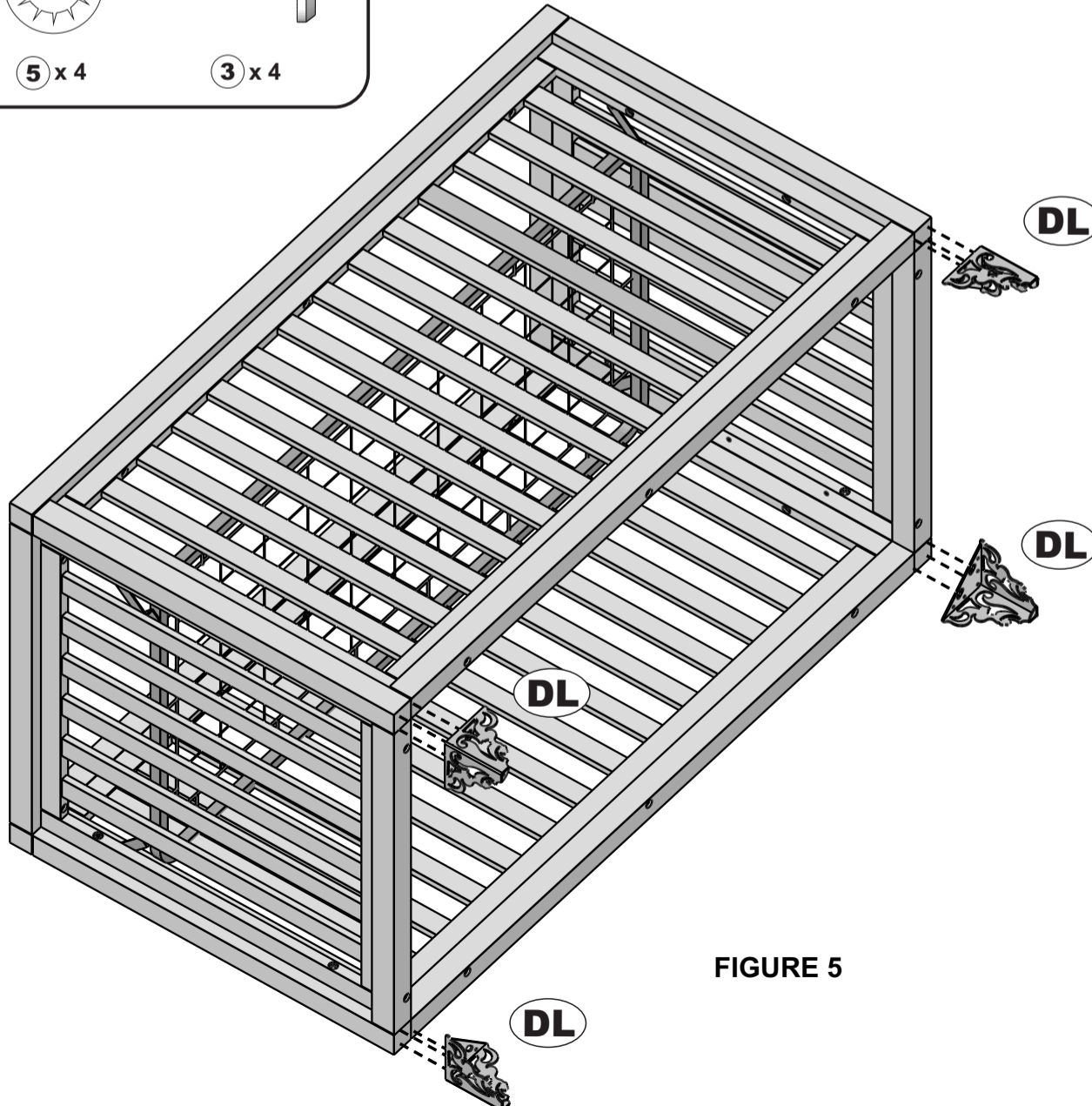

**FIGURE 5**

**STEP 5 (Two adults are required to complete this step)**

Carefully turn crib on back side (FIGURE 5) after completing **STEP 4** Place crib on soft surface (blanket or carpet).

Attach the decorative legs (DL) to the crib using 12 Allen bolts (3), 12 washers (5), and the Allen key. Take care to insert the washer between the bolt and the decorative leg!

**Completely tighten** all 12 Allen bolts (3+5) used to attach the decorative legs.

**REMINDER**

**You have to completely tighten 12 Allen bolts, distributed as following:**  
 - 12 bolts (3+5) in the decorative legs.

**WARNING:** TO KEEP YOUR BABY SECURE AND SAFE, AND TO AVOID POTENTIAL INJURY OR DEATH, IT'S **VERY IMPORTANT TO COMPLETELY TIGHTEN ALL 12 BOLTS.**

**NOTE:** THE STYLE OF YOUR CRIB, METALLIC BRACKETS OR MATTRESS SUPPORT MAY VARY FROM WHAT IS PICTURED IN THE INSTRUCTION SHEET