

# Operator's Manual

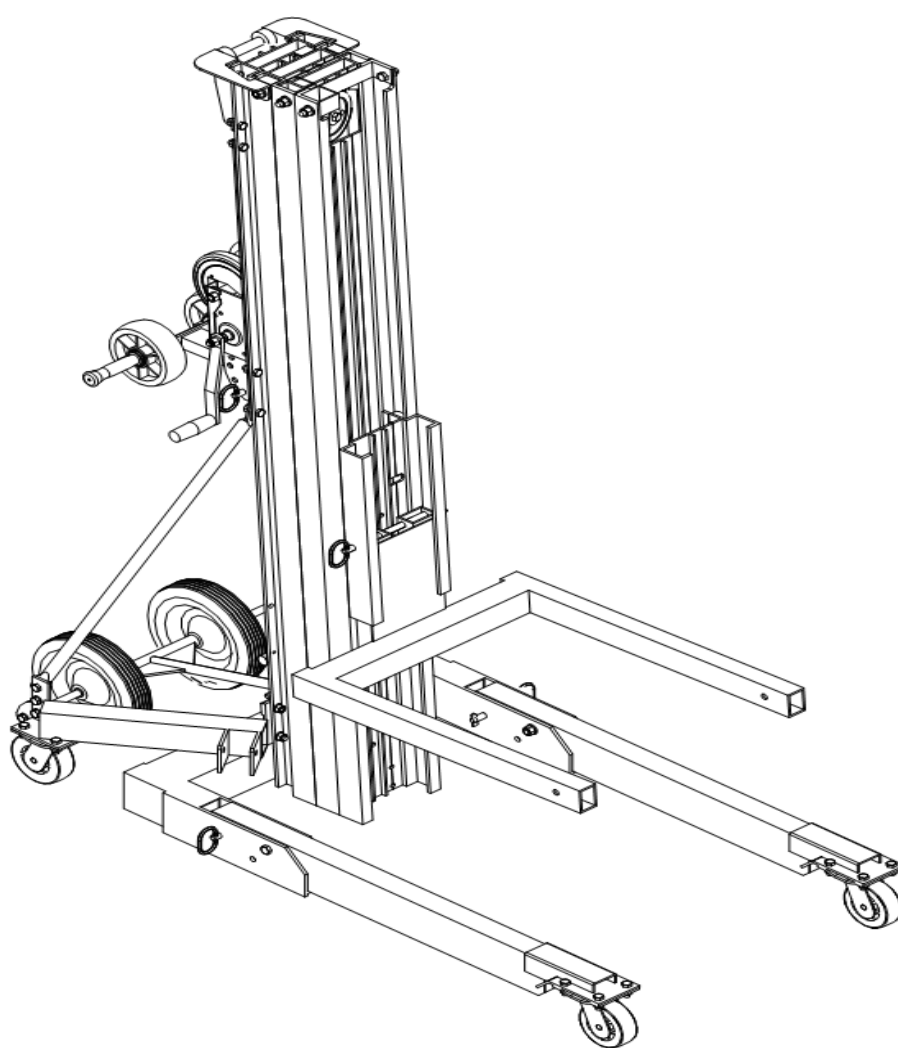

## **Very Important**

Only suitably trained, competent and authorised personnel shall be allowed to operate this machine. In addition, such person should have read and fully understood the safety rules and operating instructions BEFORE attempting to operate the machine. This manual should be attached to the machine at all times and in a position where it is clearly visible to the operators.

## **Contents**

	Page Number
Safety.....	3
Legend.....	11
Pre-Operation Inspection.....	12
Function Tests.....	14
Workplace Inspections.....	22
Operating Instructions.....	23
Load Capacity Charts.....	26
Transportation & Lifting Instructions.....	28
Specifications.....	30

.....

**DISCLAIMER:** Every effort has been made when compiling this manual to deal with all aspects of health and safety when operating this machine. It would be impossible for us to foresee every eventuality particularly when considering local terrain and environments. Accordingly, good common sense should always prevail. Ningbo Jiuding Group will not be held responsible for any errors and/or omissions within this Operating Manual.

## **Safety Rules**

### **Important Warning**

Death and/or serious injury will likely occur if the operating instructions and safety rules, as detailed in this manual, are ignored in any way.

#### **It is strictly forbidden to operate this machine unless:**

- a) You have read and fully understood the safe machine operation principles contained within the operators manual.
- b) You have performed a pre-operation inspection and confirmed everything is in order.
- c) You have carried out a full and comprehensive function test.
- d) You have carried out a full and detailed inspection of the workplace and have clearly identified all hazards and have prepared a suitable Method Statement/Risk Assessment to address any safety issues.
- e) You abide by the employer's own site safety rules and regulations.
- f) You abide by any applicable local government rules and regulations.
- g) You intend to only use the machine for the purpose it was intended.

## **Fall Hazards**

Never use this machine as a personnel lifting platform or step.

Never stand on any of the load handling attachments.

Never climb on the mast.

## **Tip Over Hazards**

Check the work area and identify holes, raised areas, drop off places, debris, slippery or unstable surfaces and anything else that might present a hazardous condition.

The machine must be on a firm and level surface before any attempt is made to lift the load.

Never use blocks of any kind to level the machine.

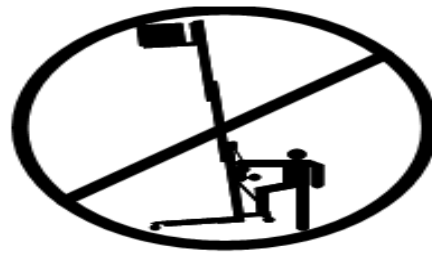
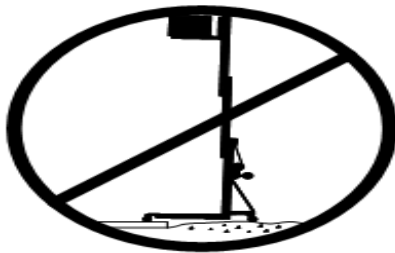

The stabilizers (if fitted) and legs must be fully lowered, locked and all castors are in full contact with the ground before any attempt is made to lift the load.

The leg retaining pins should be properly inserted through the leg and base before any attempt is made to lift the load and these pins should never be removed whilst the machine is loaded or in the raised position.

Save for minor adjustments, never move the machine when a raised load exists.

The load handling attachments must be correctly secured to the machine before any attempt is made to lift the load



Operating the machine in strong or gusty winds is not permitted as the additional surface area created by the load, if struck by the wind, could render the machine unstable.

For the same reasons as detailed above, never leave the machine in a raised load position due to the possibility that a change in the wind speed could occur at any time. If it is required that the machine is left in a raised load position, suitable guy wires should be attached.

Raising or lowering a fixed or overhanging load could cause a horizontal force or side load situation and is strictly prohibited.

Never allow ladders or scaffolding to be placed in contact with any part of the machine.

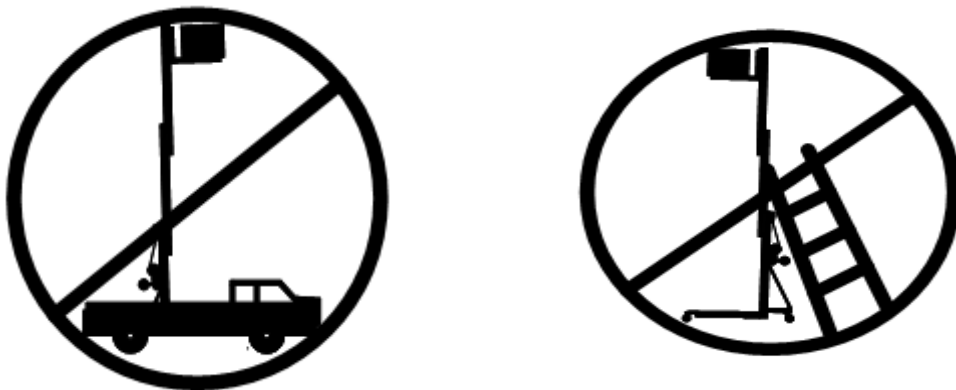

Never allow the machine to be used on any mobile or moving surface nor on any vehicle.

Never exceed the rated load capacity the details of which can be seen in the Load Capacity Charts section of this manual.

Uneven and debris littered surfaces should be avoided whilst rolling the machine with the legs in the folded position.

Never replace machine parts with items of a different weight or specification as such action could affect the stability or structure of the machine.

Never use a straddle base, flat forks, vertical barrel stacker or the rotating barrel handler on the ME-R65 or ME-R79 model .

## **Lifting Hazards**

Always use the correct lifting methods & techniques to load or tip the machine.

Always use the correct lifting methods & techniques when fitting or removing any of the load handling attachments.

## **Electrocution Hazards**

This machine is NOT electrically insulated and will NOT offer any form of protection should it come into contact with or even be in the proximity to any electrical current.

Do not go anywhere near the machine should it come into to contact with live power lines. Personnel should wait for the power lines to be shut down before attempting to move or even touch the machine.

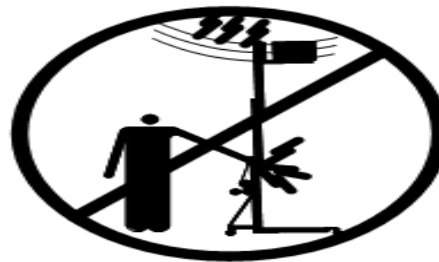

Always maintain a safe distance away from power line and other electrical appliances. Local Government rules and regulations along with the following chart should be abided by:

Voltage	Minimum Safe Approach Distance	
	Feet	Meters
0 to 300V	Avoid	Contact
300V to 50Kv	10	3.1
50Kv to 200Kv	15	4.6
200Kv to 350Kv	20	6.1
350kv to 500Kv	25	7.6
500Kv to 750Kv	35	10.7
750Kv to 1000Kv	45	13.7

Always remember that masts and power lines sway and sag and allowances should be made when calculating the safe distance. Keep in mind that additional allowances will need to be made when strong/gusty winds are present or could occur following the positioning of the machine.

Never use the machine as a ground for welding.

## **Bodily Injury Hazards**

Never touch or grasp any form of electrical cable and always assume that it might be live even if it was switched off before the work began.

## **Crushing Hazards**

Never raise the loaded machine until you are sure that the load is correctly positioned on the centre of the load handling attachment.

Never raise the loaded machine until you are sure that the load is correctly secured to the load handling attachment.

Never stand under or allow any other personnel to walk under the machine whilst it is in a raised position, loaded or otherwise. The safety brake system (where fitted) will allow the load to drop between 1 and 3 feet before locking the columns.

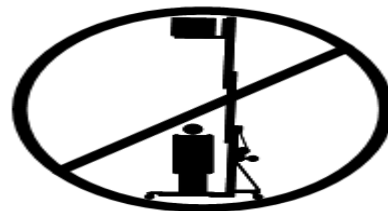

Never lower any load without first checking that the area directly below (allowing safe distance all round) is clear of any personnel or other obstructions.

Never place hands or fingers anywhere near the folding legs and be aware of any other parts of the machine where possible “pinching” could occur.

Always maintain a very firm grip on the stabilisers when the lock plates are released as the stabiliser will drop.

Always maintain a very firm grip on the legs when the retaining pins are removed as the leg will drop.

Always maintain a very firm grip on the winch handles until the brake is fully locked. The brake is locked when loaded and this will prevent the winch handles from turning.

## **Attachment Hazards**

### **Adjustable Flat Forks**

The snap pins must be correctly inserted into the forks before any attempts are made to lift the load.

### **Vertical Barrel Stacker**

The lifting arms must be correctly positioned for the size of the barrel before any attempts are made to lift the load.

The lifting arms must be correctly positioned between the ribs of the barrel before any attempts are made to lift the load.

### **Rotating Barrel Handler**

Never place hands anywhere near the rotating gears

Always apply the correct techniques to lift the barrel handler

### **Fork Extensions**

The fork extensions must be correctly secured to the machine forks before any attempts are made to lift the load.

## **Collision Hazards**

Before commencing any work with the machine, survey the entire work area for overhead obstructions and any other possible hazards. Keep in mind movable hazards such as overhead gantry cranes etc.

Never tilt the machine backwards without first checking that the area is totally clear of personnel and obstructions.

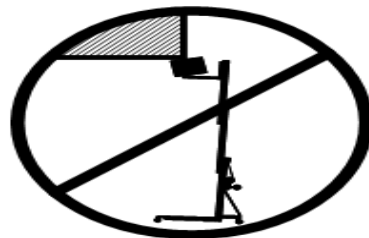

A greater degree of risk is present when transporting the machine on sloping or inclined surfaces and accordingly special consideration should be applied before commencing the move.

Never load the machine for transport unless both the machine and the transporting vehicle are on a flat and level surface. Always execute the lifting procedure using the correct lifting methods & techniques.



## **Damaged Machine/Parts Hazards**

Never use a machine which appears to be malfunctioning or shows signs of any damage whatsoever.

Never use a machine where worn, frayed, kinked or generally damaged cables are evident.

Never use a machine unless it has a minimum of 4 wraps of cable around the winch drum when the carriage is in the fully lowered position.

Never use a machine unless you have carried out a full and comprehensive pre-operation inspection and confirmed that everything is in order.

Correct lubrication on the winch should be maintained at all times. Never allow oil or grease to come into contact with the braking surfaces.

Never use any type of lubrication products on the column surfaces.

## **Unauthorised Personnel Use Hazard**

Never leave a machine unattended at any time in a loaded position so as to prevent the possibility of untrained personnel using the machine without the required instruction.

# Legend

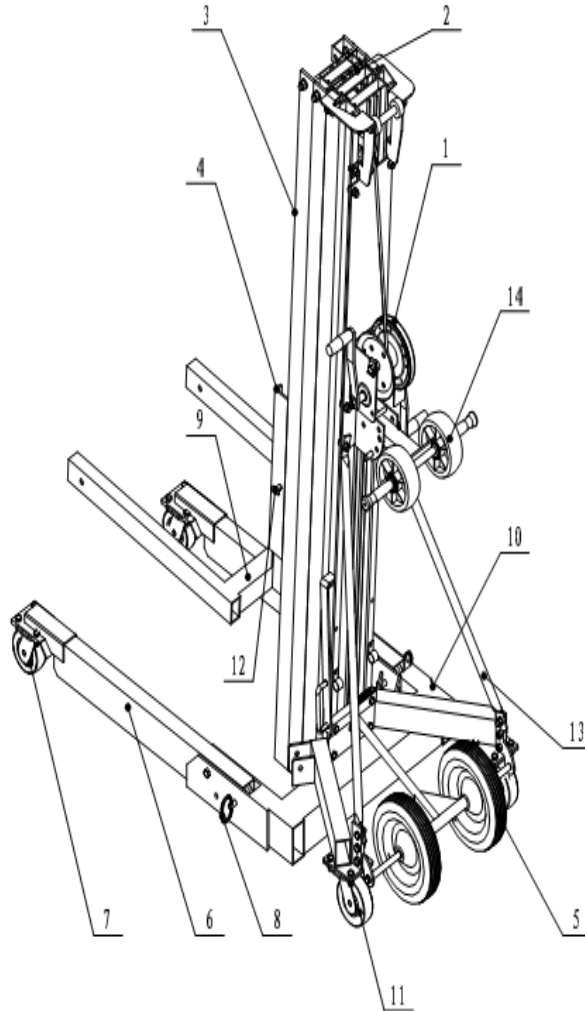

1. Winch  
2. Cable  
3. Mast  
4. Carriage  
5. Traveling wheels  
(optional)

6. Leg  
7. Leg swivel caster  
8. Leg retaining pin  
9. Hold-down bar  
(on opposite side  
of machine)

10. Standard base  
11. Base swivel/lock  
caster with brake  
12. Load handling attachment  
retaining pin  
13. Mast brace  
14. Loading wheels/steer  
handles

## **Pre-Operation Inspection**

### **Fundamentals**

The purpose of the Pre-Operation Inspection is to allow the operator, prior to the commencement of each work shift period, to execute a comprehensive visual inspection of the machine to ascertain if anything obvious is wrong before proceeding to the Function Test procedure.

The Pre-Operation Inspection should pay particular attention to the identification of any machine modifications, damaged, loose or missing parts.

If the Pre-Operation Inspection reveals any modifications (save for those carried out by a qualified service Engineer in accord with the manufacturer's specifications and guidelines) damage, loose or missing parts, the machine should immediately be quarantined and tagged as not fit for service.

Once any damage, loose or missing parts have been dealt with by a qualified service Engineer in accord with the manufacturer's specifications and guidelines, a further Pre-Operation Inspection should be performed again before proceeding to the Function Test section.

#### **You are reminded that it is strictly forbidden to operate this machine unless:**

- h) You have read and fully understood the safe machine operation principles contained within the operators manual.
- i) You have performed a pre-operation inspection and confirmed everything is in order.
- j) You have carried out a full and comprehensive function test.
- k) You have carried out a full and detailed inspection of the workplace and have clearly identified all hazards and have prepared a suitable Method Statement/Risk Assessment to address any safety issues.
- l) You abide by the employer's own site safety rules and regulations.
- m) You abide by any applicable local government rules and regulations.
- n) You intend to only use the machine for the purpose it was intended.

## **Pre-Operation Inspection - Continued**

The following components should be checked for signs of unauthorised modifications, damaged, loose or missing parts:

- Winch and any related components
- Legs
- Stabilisers and latch plates (if fitted)
- Base components
- Mast Columns
- Carriage hold down bar
- Plastic shim (exterior) for safety brake (if fitted)
- Cable anchor
- All cables and pulleys (look out for kinks, frays or general abrasions on cables)
- All wheels and castors
- All nuts, bolts and any other fasteners
- Load handling attachments (if fitted)

The entire machine should also be checked for the following:

- General impact damage and dents
- Any signs of metal oxidation and/or corrosion
- Any hairline cracks of the welds and other structural components

Be certain that all structural and other vital components are in place and all of the fasteners and locking pins are in place and securely tightened

Double check that the winch drum has a minimum of 4 wraps of cable around it when the carriage is in the fully lowered position.

## **Function Tests**

### **Fundamentals**

The purpose of the Function Tests is to ascertain if the machine is suffering from any malfunctions before it is put into service. The operator should carefully complete each of the step by step instructions given to test all of the machines functions

If the Function Tests reveal any malfunction whatsoever, the machine should immediately be quarantined and tagged as not fit for service.

Once any repairs have been dealt with, by a qualified service Engineer in accord with the manufacturer's specifications and guidelines, a further Pre-Operation Inspection and Function Tests should be performed again before allowing the machine back into service

#### **You are reminded that it is strictly forbidden to operate this machine unless:**

- o) You have read and fully understood the safe machine operation principles contained within the operators manual.
- p) You have performed a pre-operation inspection and confirmed everything is in order.
- q) You have carried out a full and comprehensive function test.
- r) You have carried out a full and detailed inspection of the workplace and have clearly identified all hazards and have prepared a suitable Method Statement/Risk Assessment to address any safety issues.
- s) You abide by the employer's own site safety rules and regulations.
- t) You abide by any applicable local government rules and regulations.
- u) You intend to only use the machine for the purpose it was intended.

## Function Tests - Continued

A solid and level surface should be selected for the tests and the area should be totally free from any obstructions which may hinder the tests to be carried out effectively.

### Set-up

#### Machines without Stabilisers

- a) Extract the leg retainer pin and carefully lower the leg to the fully down position. Insert the pin back through the leg and the base.

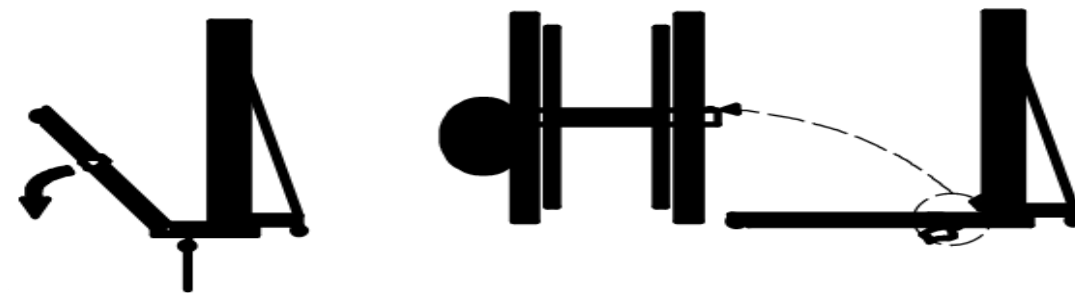

- a) Apply downward pressure to release the stabiliser lock plates and carefully lower the stabilisers to the ground ensuring that the castors make full contact with the surface. Double check that the stabilisers are locked in the fully down position.



- b) Extract the leg retainer pin and carefully lower the leg to the fully down position. Insert the pin back through the leg and the base.

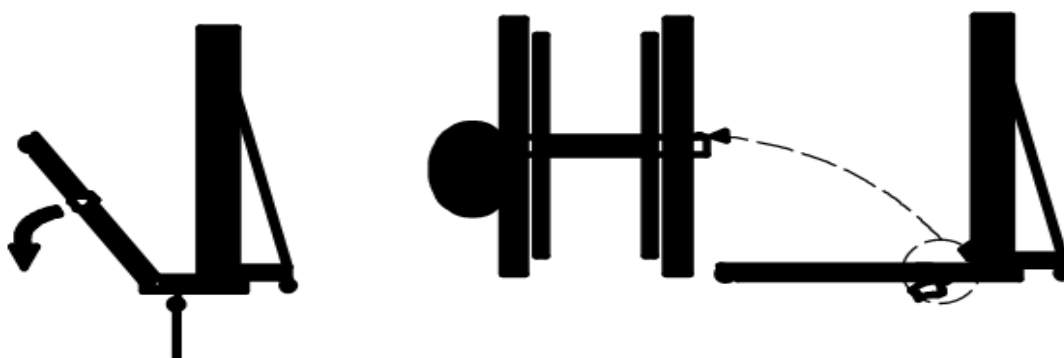

### **Straddle Base**

- a) Insert a 2 Inch/5.1cm solid block under the swivel caster of one leg.
- b) On the opposite adjustable arm, loosen the arm lock knob.
- c) Place the adjustable to the desired width
- d) Whilst fully supporting the leg assembly, fully tighten the arm lock knob.

The above 4 instructions should be repeated for the second arm.

### **Standard Forks & Standard Fork Options**

- a) Position the forks inside the carriage.
- b) Insert the retaining pin

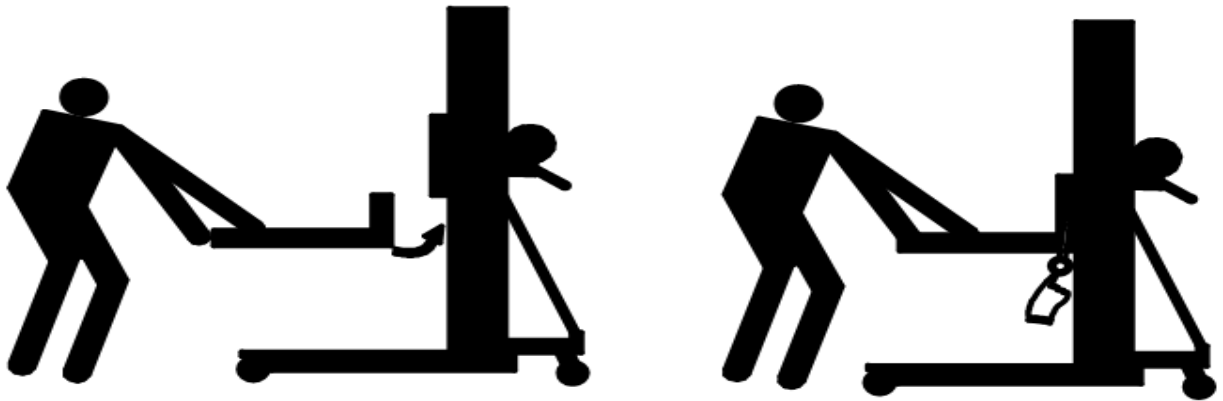

### **Load Platform with Standard Forks**

- a) Position the load platform onto the standard forks.

### **Pipe Cradle**

- a) Attach the pipe cradles to the forks ensuring that the fasteners are fully tightened.

### **Fork Extensions**

- a) Slide each of the extension tubes onto its respective fork.
- b) Once in the desired position, insert a retaining pin in each fork.

## Function Tests - Continued

### Adjustable Forks & Adjustable Fork Options

- a) Position the forks inside the carriage.
- b) Insert the retaining pin

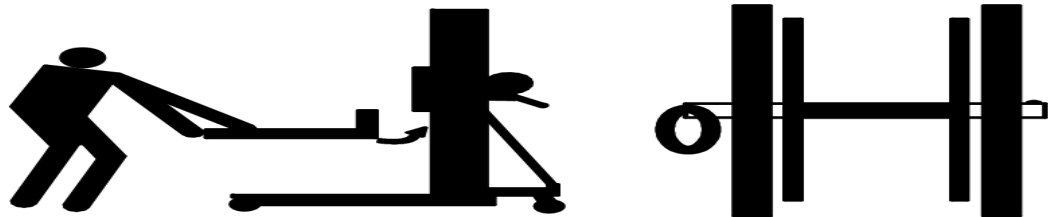

- c) Once at the desired width, correctly insert a retaining snap pin in each fork

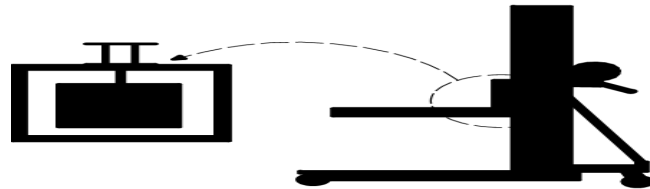

### Load Platform with Adjustable Forks

- c) Position the forks to a width of 23 Inch/58.4cm
- d) Position the load platform onto the adjustable forks.

### Pipe Cradle

- a) Attach the pipe cradles to the forks ensuring that the fasteners are fully tightened.

### Fork Extensions

- d) Slide each of the extension tubes onto its respective fork.
- e) Once in the desired position, insert a retaining pin in each fork.

### Flat Forks

- a) Position the fork mounting bracket inside the carriage.

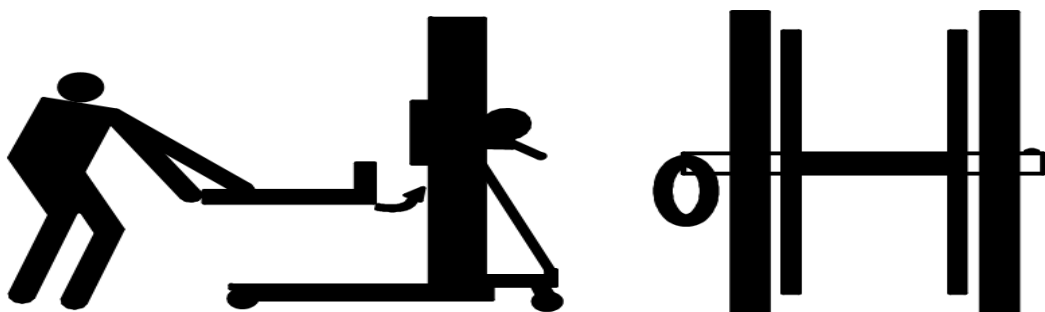



- c) Once at the desired width, correctly insert a retaining snap pin in each fork.

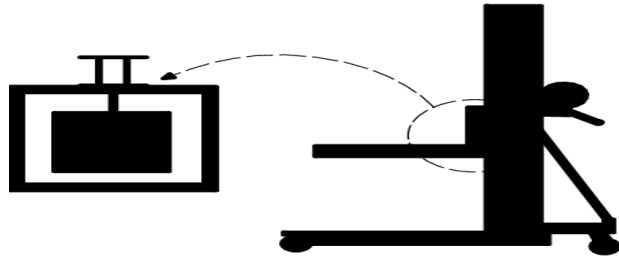

### Standard Boom

- a) Position the forks inside the carriage.  
b) Insert the retaining pin.

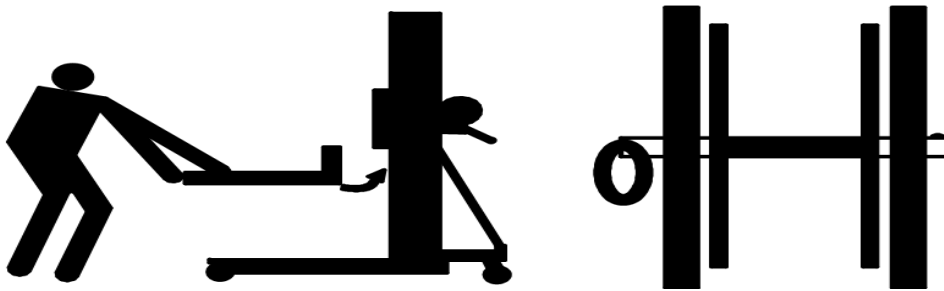

- c) Attach the lifting shackle onto the desired hole on the boom.

## **Function Tests – Continued**

### **Vertical Barrel Stacker**

- a) Position the barrel stacker mounting bracket inside the carriage.
- b) Insert the retaining pin.
- c) Adjust the arms to the desired position by raising, moving and lowering the arm
- d) The barrel stacker should be pushed against the barrel until the lifting arms completely surround the barrel and are positioned between the ribs of the barrel.

### **Rotating Barrel Handler**

- a) Using the correct lifting methods & techniques, position the rotating barrel handler on the ground and between the legs of the machine.
- b) Carefully lower the carriage down over the mounting bracket and insert the retaining pin.
- c) Turn the crank handle to position the barrel cradle.



- d) Push the barrel cradle against the barrel.
- e) Release the buckle and attach the strap to the buckle. Using the ratchet fitted to the buckle, tighten the strap ensuring it is tight.
- f) The raising and lowering of the barrel can be performed by using the winch whilst the crank handle can be used to rotate the barrel.

## Function Tests - Continued

### Speed Winch Operation – Test No 1

- c) Position a load handling attachment on the machine.
- d) Rotate the winch handles towards the mast to raise the carriage.

The above test can be considered successful if the winch operated smoothly, without any stutter or binding.

- e) Rotate the winch handles away from the mast to lower the carriage. After reaching the desired position, rotate the winch handles a quarter of a turn towards the mast (as if to raise the carriage) to set the brakes.

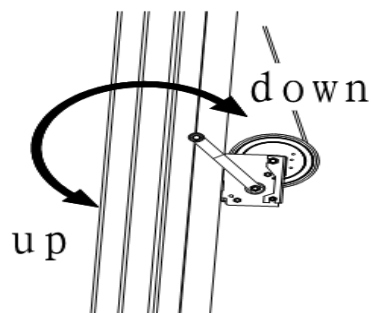

The above test can be considered successful if the winch operated smoothly, without any stutter or binding.

### Speed Winch Operation – Test No 2

- a) Position a load handling attachment on the machine.
- b) Move the winch to slow speed.
- c) Rotate the winch handles towards the mast to raise the carriage.

The above test can be considered successful if the winch operated smoothly, without any stutter or binding.

- f) Rotate the winch handles away from the mast to lower the carriage. After reaching the desired position, rotate the winch handles a quarter of a turn towards the mast (as if to raise the carriage) to set the brakes.

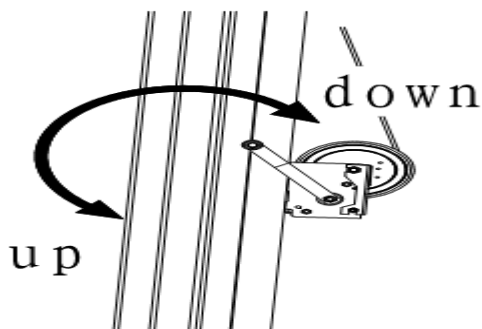

The above test can be considered successful if the winch operated smoothly, without any stutter or binding.

- g) Move the winch to fast speed and repeat steps c & d. Again, this test can be considered successful if the winch operated smoothly, without any stutter or binding.

### **Mast Sequencing Test**

- g) Position a load handling attachment on the machine.
- h) Rotate the winch handles towards the mast to raise the carriage to its full height.

The above test can be considered successful if the carriage rose to the top of the front section of mast followed, in consecutive order, by the remaining mast sections, smoothly and without any stutter or binding.

- i) Rotate the winch handles away from the mast to lower the carriage. After reaching the desired position, rotate the winch handles a quarter of a turn towards the mast (as if to raise the carriage) to set the brakes.

## **Workplace Inspection**

### **Fundamentals**

The purpose of the Workplace Inspection is to ascertain, prior to moving the machine into the area, if the intended workplace is suitable for the safe operation of the machine.

As the operator may not be totally familiar with the workplace, they should be extra vigilant and cautious when looking out for possible hazards.

Keep in mind and avoid the following:

- Generally hazardous locations.
- Holes, raised areas, drop off places, debris, slippery or unstable surfaces and anything else that might present a hazardous condition.
- Overhead obstructions and in particular high voltage power lines and conductors
- Unsuitable wind and weather conditions. It is also good practise to obtain a local weather forecast to adequately cover the period of the intended work time.
- Any other possible unsafe conditions.

**You are reminded that it is strictly forbidden to operate this machine unless:**

- v) You have read and fully understood the safe machine operation principles contained within the operators manual.
- w) You have performed a pre-operation inspection and confirmed everything is in order.
- x) You have carried out a full and comprehensive function test.
- y) You have carried out a full and detailed inspection of the workplace and have clearly identified all hazards and have prepared a suitable Method Statement/Risk Assessment to address any safety issues.
- z) You abide by the employer's own site safety rules and regulations.
- aa) You abide by any applicable local government rules and regulations.
- bb) You intend to only use the machine for the purpose it was intended.

## **Operating Instructions**

### **Fundamentals**

The machine was designed for the lifting of materials and using it for any other purpose is unsafe and therefore strictly forbidden.

If the machine is to have multiple operators over one same day shift, the new operator must perform a pre-operation inspection, function tests & a workplace inspection before using the machine and he must not rely on the results of the previous users tests or indeed his own previous tests if they are using it for a second or more time in the same shift. For the avoidance of doubt, if an operator has left the machine unattended for whatever reason or for whatever period of time and there is the slightest chance that some other operator could have used the machine in their absence, all 3 test procedures must be carried out again before commencing any usage of the machine.

**You are reminded that it is strictly forbidden to operate this machine unless:**

- cc) You have read and fully understood the safe machine operation principles contained within the operators manual.
- dd) You have performed a pre-operation inspection and confirmed everything is in order.
- ee) You have carried out a full and comprehensive function test.
- ff) You have carried out a full and detailed inspection of the workplace and have clearly identified all hazards and have prepared a suitable Method Statement/Risk Assessment to address any safety issues.
- gg) You abide by the employer's own site safety rules and regulations.
- hh) You abide by any applicable local government rules and regulations.
- ii) You intend to only use the machine for the purpose it was intended.

## **Operating Instructions - Continued**

### **Set Up**

A solid and level surface should be selected for the set up and the area should be totally free from any obstructions which may hinder the set up to be carried out effectively.

Carefully follow the set up instructions and procedures detailed in the Function Tests section of this manual.

### **Raising & Lowering Loads**

- a) The loads should be centred on the load handling attachment and in strict accord with the Load Capacity Charts detailed within this manual.
- b) Ensure that the load is fully secured to the load handling attachment.
- c) Rotate the winch handles towards the mast to raise the load. Never allow any uneven winding of the cable onto the drum.

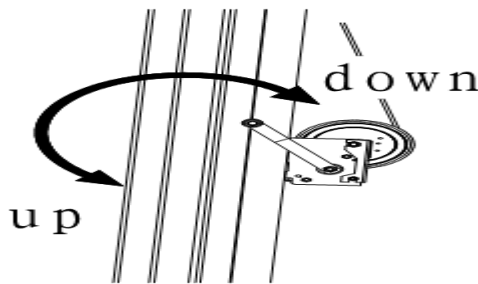

- d) Rotate the winch handles away from the mast to lower the load. After reaching the desired position, rotate the winch handles a quarter of a turn towards the mast (as if to raise the carriage) to set the brakes.

### **Moving the Machine with a Load**

Best practise is to avoid moving the machine whilst it is loaded and in any event, the moving of the machine in a raised load position should be restricted to the placement for loading or unloading. If it is absolutely necessary to move the machine with a raised load, the following guidelines are the minimum that should be considered:

- Ensure that the area of travel is level and totally clear of any obstructions.
- Ensure that the load is centred on the load handling attachment.
- Ensure that the load is fully secured to the load handling attachment.
- Ensure that sudden starts, stops and general jerky movements are avoided.
- Ensure that the total area of travel is free from personnel.
- Ensure that personnel are kept away from the machine and the load.

### **Storage after use**

To make the machine ready for storage, simply follow the set up procedures detailed in the Function Tests section of this manual but in reverse order.

To maintain the machine in a first class condition, a safe and secure storage area should be selected which is a firm and level surface, offering good protection against inclement weather and where the risk of impact damage etc from other vehicles and machines can be avoided.



## **Load Capacity Charts**

### **IMPORTANT WARNING**

Death and/or serious injury will likely to occur in the event that any load has not been positioned correctly.

Death and/or serious injury will likely to occur in the event of any attempt to raise a load which exceeds the capacity of the machine.

Death and/or serious injury will likely to occur in the event that any load has not been positioned within the load centre zone.

Always confirm and double check that the load you wish to raise does not exceed the maximum load for the load centre as shown in the Load Capacity Charts detailed within this manual.

The definition of a load centre is the balancing point (the centre of gravity) of a load and it must always be positioned within the load centre zone.

### **Load Positioning Instructions for Forks**

- e) Ascertain the exact weight of the proposed load and the location of its load centre.
- f) From the side of the load that will be closest to the carriage, measure to the load centre.
- g) Using the Load Capacity Charts detailed within this manual, confirm if the machine is capable of lifting the weight at the proposed location on the forks.
- h) Position the load on the forks so that it sits as close to the carriage as possible.
- i) Ensure that the load is fully secured to the forks.

### **Load Positioning Instructions for the Boom**

- a) Ascertain the exact weight of the proposed load and the location of its load centre.
- b) Using the Load Capacity Charts detailed within this manual, confirm if the machine is capable of lifting the weight at the proposed location on the boom.
- c) Ensure that the load is fully secured to the lifting shackle on the boom.

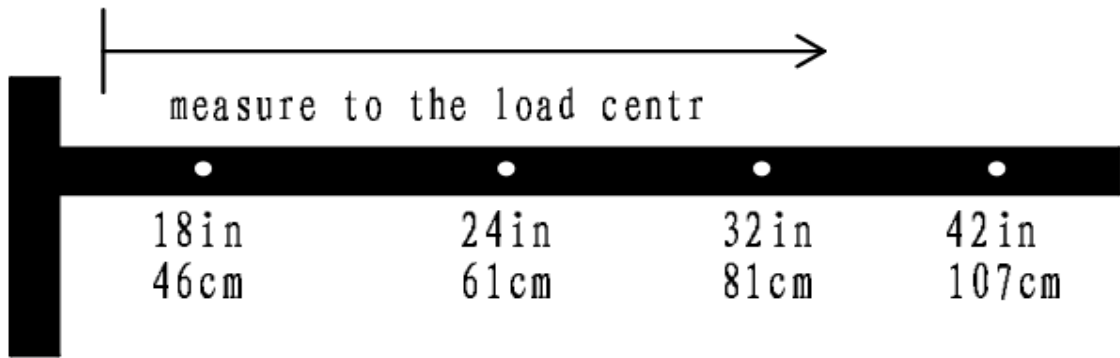

<b>Maximum Load Centres</b>		
All measurements from the front of the carriage.		
Standard Forks	24 Inches	61cm
Adjustable Forks	24 Inches	61cm
Boom	42 Inches	107cm
Flat Forks	28 Inches	71cm
Vertical Barrel Stacker	Equivalent to 24 Inches	
Rotating Barrel Handler:		
30 gallon barrels	Equivalent to 38 Inches	
55 gallon barrels	Equivalent to 30 Inches	
Load Platform	24 Inches	61cm
Pipe Cradle	18 Inches	46cm
Fork Extensions	42 Inches	107cm

<b>Load Capacity Chart</b>					
<b>Load Centre</b>					
Inches		15.7	23.6	31.5	39.4
CM		40	60	80	100
<b>Model</b>					
ME-R35	lbs	771	771	550	330
	kg	350	350	250	150
ME-R50	lbs	660	600	550	330
	kg	300	300	250	150
ME-R65	lbs	550	440	330	220
	kg	250	200	150	100
ME-R79	lbs	440	330	220	165
	kg	200	150	100	75

## **Transportation & Lifting Instructions**

### **Before doing anything with the machine, ensure:**

- j) The vehicle that is to be used to transport the machine is parked on a firm and level surface.
- k) The handbrake on the vehicle is in good working order and will prevent the vehicle from rolling backwards or forwards during the loading process.
- l) The machines weight is clearly visible on the attached serial plate and the transporting vehicle, its loading surfaces, chains or straps should be checked to ensure they are adequate to transport the machine.
- m) Without exception, the machine needs to be adequately secured to the transporting vehicle with chains or straps before any attempts to move the transporting vehicle are made.

### **Loading the Machine**

Any load handling attachment should be removed from the machine and stabilisers placed in the stored position.

- a) Ensure that the carriage is fully lowered and locked for transportation.
- b) Ensure that the carriage hold-down bar is rotated over the carriage.
- c) Ensure that the carriage is raised slightly so that it makes contact with the carriage hold-down bar.
- d) Adjust the loading wheels to the desired position and ensure that the pin is correctly inserted.
- e) Lock the casters on the rear base.

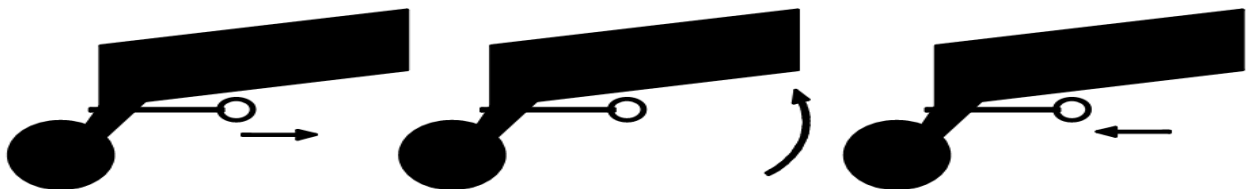

- f) Position the machine against the transporting vehicle and, using the correct lifting methods & techniques, load the machine onto the transporting vehicle. Double check the carriage and ensure it is locked in the lowered position.

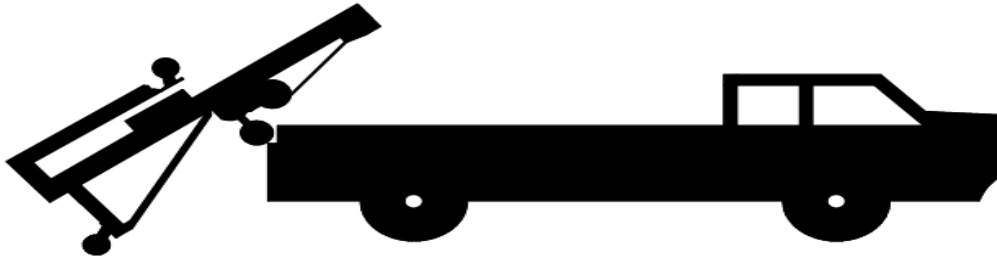

- g) Enough chains or straps should be used to secure the machine to the transporting vehicle's loading bed. Avoid placing any chains or straps around the legs as doing so could cause damage to the legs.

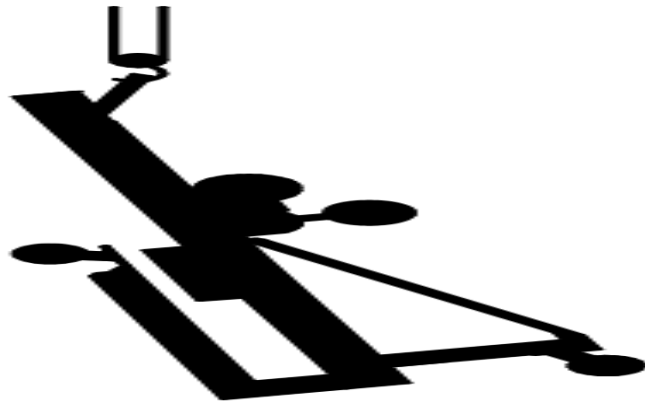

- h) The off-loading procedure is the reverse of the loading procedure above.

### **Loading the Machine with a Crane**

- a) Ensure that the legs and stabilisers are in the stored position.
- b) Ensure that the machine is inspected and any loose or unsecured items are removed.
- c) Always lift the machine using the lifting bracket provided on the top of the rear mast column.
- d) Ensure that the lifting hook is placed through the lifting bracket so that it points away from the machine.

# Specifications

<b>Model</b>		ME-R35	ME-R50	ME-R65	ME-R79
<b>Height-Stowed</b>		78 <sup>1</sup> / <sub>2</sub> in	78 <sup>1</sup> / <sub>2</sub> in	78 <sup>1</sup> / <sub>2</sub> in	78 <sup>1</sup> / <sub>2</sub> in
		2 m	2 m	2 m	2 m
<b>Width</b>		31 <sup>1</sup> / <sub>2</sub> in	31 <sup>1</sup> / <sub>2</sub> in	31 <sup>1</sup> / <sub>2</sub> in	31 <sup>1</sup> / <sub>2</sub> in
<b>Standard Base</b>		80 cm	80 cm	80 cm	80 cm
<b>Width-stabilizers lowered</b>		78 <sup>5</sup> / <sub>8</sub> in	78 <sup>5</sup> / <sub>8</sub> in	78 <sup>5</sup> / <sub>8</sub> in	78 <sup>5</sup> / <sub>8</sub> in
	<b>Standard Base</b>	2 m	2 m	2 m	2 m
<b>Width-Min</b>		31 <sup>1</sup> / <sub>2</sub> in	31 <sup>1</sup> / <sub>2</sub> in	NA	NA
<b>Straddle Baes</b>		80 cm	80 cm		
<b>Width-Max</b>		58in	58 in	NA	NA
<b>Straddle Baes</b>		1.5m	1.5m		
<b>Length-Stowed</b>	29 in	74 cm	29 in	29 in	31 in
			74 cm	74 cm	79 cm
<b>Length-Operating</b>		59 <sup>1</sup> / <sub>2</sub> in	72 <sup>1</sup> / <sub>2</sub> in	80 <sup>1</sup> / <sub>2</sub> in	80 <sup>1</sup> / <sub>2</sub> in
		1.5 m	1.8 m	2 m	2 m
<b>Ground Clearance</b>		2 in	2 in	2 in	2 in
		50.8mm	50.8mm	50.8mm	50.8mm
<b>Load Capacity</b> at 15.7 inch/40 cm load center		771 lbs	660 lbs	550 lbs	400 lbs
		350 kg	300 kg	250 kg	200 kg
Note: See Load Capacity Charts section for load capacity at other load centers.					
<b>Net Weight-Standard Base</b>		260 lbs	317 lbs	405 lbs	450 lbs
		117.9 kg	143.8 kg	183.7 kg	204.1 kg
<b>Net Weight-Straddle Base</b>		303 lbs	360 lbs	NA	NA
		137.4 kg	163.3 kg		
<b>Load Handling Attachments</b>		<b>Length</b>	<b>Width</b>	<b>Depht</b>	<b>Net Weight</b>
Standard Forks		27 <sup>1</sup> / <sub>2</sub> in	23 <sup>1</sup> / <sub>2</sub> in	2 <sup>1</sup> / <sub>2</sub> in	38 lbs
		70 cm	60cm	6.4 cm	17.2 kg
Adjustable Forks		27 <sup>1</sup> / <sub>2</sub> in	11 <sup>1</sup> / <sub>2</sub> in to 30 in	2 <sup>1</sup> / <sub>2</sub> in	52.5 lbs
		70 cm	29 cm to 76 cm	6.4 cm	23.8 kg
Flat Forks		32 in	16 in to 31 in	1 <sup>1</sup> / <sub>2</sub> in	73 lbs
		81 cm	41 cm to 79 cm	3.8 cm	33.1 kg
Boom		18 in to 42 in	1 <sup>1</sup> / <sub>2</sub> in	6 <sup>1</sup> / <sub>2</sub> in	34.5 lbs
		46 cm to 1.1 m	4 cm	16.5 cm	15.6 kg

Vertical Battel Stacker	21 in	29 in	NA	50.5 lbs
	53 cm	74 cm		22.9 kg
Rotating Barrel Handler	29 in	31 in	NA	90 lbs
	74 cm	79 cm		40.8 kg
Pipe Cradle	27 1/2 in	24 1/2 in	6 in	10 lbs
	70 cm	63 cm	15.2 cm	4.5 kg
Load Platform	27 1/2 in	23 1/2 in	2 1/2 in	26.5 kbs
	70 cm	60 cm	6.4 cm	12 kg
Fork extensions(each)	30 in	2 in	3 in	4.5 lbs
	76 cm	5 cm	7.6 cm	2 kg