

# 9713 Foam insert Hex screwdriver set 1, 12 pieces

Foam inserts for roller cabinet

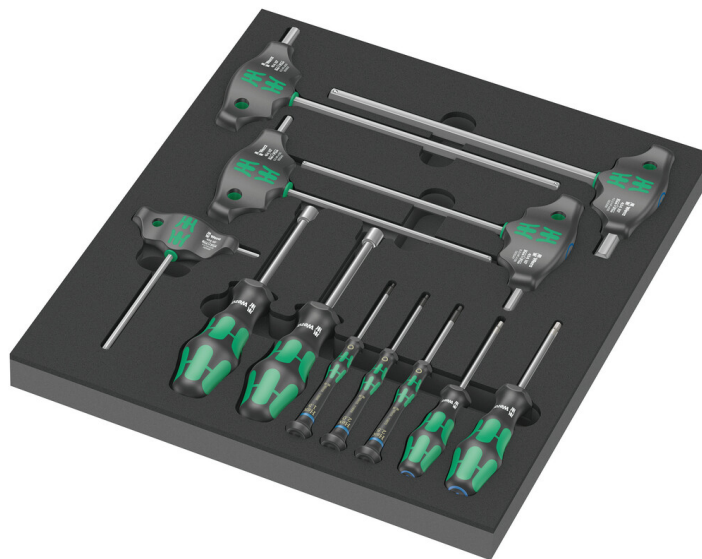

<b>EAN:</b>	4013288225290	<b>Size:</b>	405x360x60 mm
<b>Part number:</b>	05150104001	<b>Weight:</b>	1961 g
<b>Article number:</b>	9713	<b>Country of origin:</b>	CZ
		<b>Customs tariff number:</b>	82054000

- Durable foam insert, each tool has its own place; two-coloured, missing tools will quickly be noticed
- High-quality, durable foam insert without chemical vapours
- Optimum fit for the best possible removal of the tools from the foam insert
- Water- and oil-repellent, low maintenance and easy to clean
- Protection of the tool from dirt and impact
- 4 Kraftform Plus screwdrivers with hard zones for high working speeds and soft handle zones for a high torque transfer, two of which with hollow shaft for protruding thread rods
- 3 Kraftform Micro screwdrivers with a rotating cap for fast turning
- 5 T-handle screwdrivers for the transmission of particularly high tightening and loosening moments, with holding function for hexagonal socket screws

Durable foam insert; two-coloured for quick identification of missing parts; suitable for the Tool Rebel roller cabinet, equipped with 10 Wera screwdrivers (workshop, Micro and T-handle) for hexagonal socket screws and 2 Wera screwdrivers with hollow shaft for external hexagon screws.

## Web link

[https://products.wera.de/en/roller\\_cabinet\\_and\\_foam\\_inserts\\_foam\\_inserts\\_for\\_roller\\_cabinet\\_9713.html](https://products.wera.de/en/roller_cabinet_and_foam_inserts_foam_inserts_for_roller_cabinet_9713.html)

Wera - 9713  
05150104001 - 4013288225290



Foam inserts for roller cabinet

Safe storage and quick overview

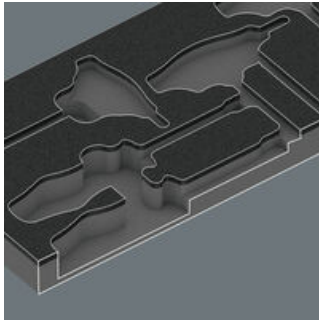

The tools sit securely in the foam thanks to precise contour cutouts, but are easy to remove. The carefully designed arrangement of the tools ensures space-saving storage and quick access to each tool.

Two-coloured foam insert

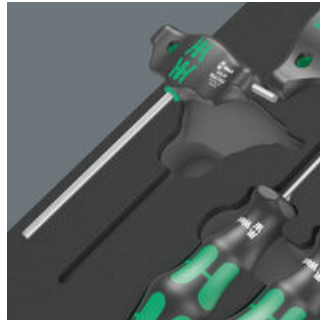

After removing the tool the light grey second foam becomes visible and therefore missing tools are quickly identified.

Wera Black Point tip

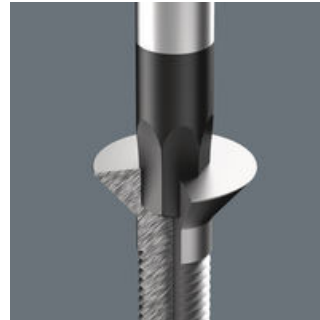

The Wera Black Point tip and a refined hardening process ensure long service life of the tip, improved corrosion protection and an exact fit.

T-handle screwdriver with holding function for hexagonal socket screws



A resilient ball ensures the hexagon socket screw to be clamped on the tool tip. Especially helpful in hard to reach areas where you can not use your other hand to hold the screw.

Second arm



The additional short arm, which emerges laterally from the handle, allows the transmission of extremely high torques by using the long arm as a lever.

High torque transfer

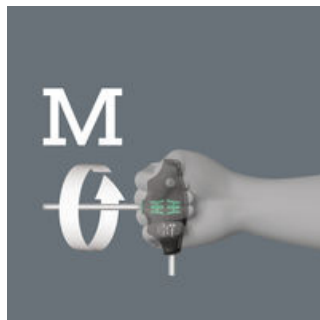

By using the blade as an extension of your lower arm you can transfer particularly high torque.

Hollow shaft nutsetter

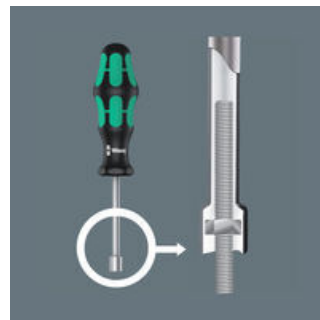

Screwdrivers with a hollow shaft are useful for screwdriving on thread rods, as the thread rod can penetrate into the hollow shaft of the screwdriver and the nut can be operated.

Kraftform Micro screwdriver



The Kraftform Micro screwdrivers with their power-, fast rotating- and precision zones perfectly meet the requirements for precision mechanical couplings. The smooth-running cap, on which you can rest your hand, ideally supports these advantages.

Web link

[https://products.wera.de/en/roller\\_cabinet\\_and\\_foam\\_inserts\\_foam\\_inserts\\_for\\_roller\\_cabinet\\_9713.html](https://products.wera.de/en/roller_cabinet_and_foam_inserts_foam_inserts_for_roller_cabinet_9713.html)

Wera - 9713  
05150104001 - 4013288225290



Wera Werkzeuge GmbH  
Korzter Straße 21-25  
D-42349 Wuppertal  
Tel: +49 (0)2 02 / 40 45-0  
E-Mail: info@wera.de

## 9713 Foam insert Hex screwdriver set 1, 12 pieces



### Foam inserts for roller cabinet

#### Set contents:



#### 354 Screwdriver for hexagon socket screws, 3 x 75 mm

	05023110001	1x	3 x 75 mm
	05023115001	1x	4 x 75 mm



#### 2054 Screwdriver for hexagon socket screws for electronic applications, 1.5 x 60 mm

	05118066001	1x	1.5 x 60 mm
	05118068001	1x	2 x 60 mm
	05118070001	1x	2.5 x 60 mm

#### 454 HF T-handle hexagon screwdriver Hex-Plus with holding function, 4 x 100 mm

	05023338001	1x	4 x 100 mm
	05023342001	1x	5 x 100 mm
	05023347001	1x	6 x 150 mm
	05023353001	1x	8 x 200 mm
	05023355001	1x	10 x 200 mm

#### 395 HO Nutdriver, 10 x 90 mm

	05029465001	1x	10 x 90 mm
	05029466001	1x	13 x 90 mm

#### 9813 Foam insert Hex screwdriver set 1, empty, 344 x 30 x 392 mm

05137313001 <sup>1)</sup>	1x	344 x 30 x 392 mm
---------------------------	----	-------------------

1) Attention: The foam insert does not fit in the previous model 05501051001 of the roller cabinet.

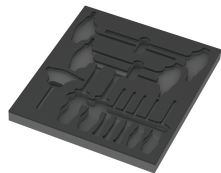

#### Web link

[https://products.wera.de/en/roller\\_cabinet\\_and\\_foam\\_inserts\\_foam\\_inserts\\_for\\_roller\\_cabinet\\_9713.html](https://products.wera.de/en/roller_cabinet_and_foam_inserts_foam_inserts_for_roller_cabinet_9713.html)

Wera - 9713

05150104001 - 4013288225290

Wera Werkzeuge GmbH

Korzter Straße 21-25

D-42349 Wuppertal

Tel: +49 (0)2 02 / 40 45-0

E-Mail: [info@wera.de](mailto:info@wera.de)