

367 TORX® B0 Screwdriver for tamper-proof TORX® screws, TX 8 x 60 mm

Kraftform Plus – Series 300



EAN:	4013288039972	Size:	141x26x26 mm
Part number:	05138258001	Weight:	30 g
Article number:	367 TORX® B0	Country of origin:	CZ
		Customs tariff number:	82054000

- Screwdrivers for recessed TORX® screws with safety pin
- Multi-component Kraftform handle for fast and ergonomic screwdriving
- For TORX® socket screws with safety pin
- Handle markings simplify finding and sorting of tools
- The Wera Black Point tip offers an exact fit and optimum corrosion protection

High quality Kraftform Plus screwdriver. Multi-component Kraftform handle for fast and low-fatigue working. TORX® B0 screws have a protruding pin in their drive profile. This prevents any unauthorised loosening since the "normal" hex tools cannot move these screws. Only special TORX® B0 tools have a bore hole which can slip over the pin. The Wera Black Point tip and a complex hardening process ensure a long service life of the tip, enhanced corrosion protection and an exact fit. The hexagonal anti-roll feature prevents any bothersome rolling away at the workplace. Handle markings for simplified finding and sorting of the tool.



Web link

https://products.wera.de/en/screwdrivers_kraftform_plus_series_300_367_torx_bo.html

Wera - 367 TORX® B0
05138258001 - 4013288039972

Wera Werkzeuge GmbH
Korzter Straße 21-25
D-42349 Wuppertal
Tel: +49 (0)2 02 / 40 45-0
E-Mail: info@wera.de

TORX® with borehole (B0)



Kraftform Plus screwdrivers - ergonomics you can grasp. They relieve the entire hand-arm system even when used intensively. Along with other technical and product advantages such as the Lasertip for a secure fit in the screw head, Kraftform screwdrivers are the ideal choice whenever manual screwdriving jobs are concerned.

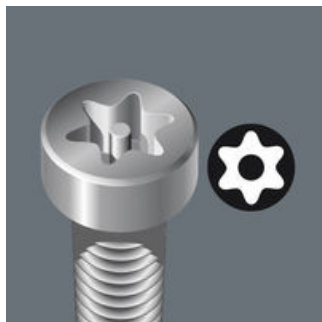

TORX® tools with a borehole prevent the unauthorised unfastening of safety screws. The screws contain a pin that protrudes into the drive profile so that "normal" TORX® tools cannot be used. This pin fits into the borehole of TORX® B0 tools allowing safety screws to be unfastened.

Kraftform



The basic idea for the prototype of the Kraftform handle - that the hand should dictate the design - has, right through to today, proved to be correct. In cooperation with the internationally recognised Fraunhofer IAO Institute, Wera developed a screwdriver handle designed to match the shape of the human hand as long ago as the 1960s. After a long development phase, the Wera Kraftform handle was launched to the market in 1968. It has been optimised through the years with new technologies, but has kept its proven shape. After all, the human hand has not changed either.

Large contact area



The large contact area - with particularly high friction to the soft zones - results in high torque transfer without any bruising from the edges.

Rapid hand repositioning



The hard materials used for the handle ensure rapid hand repositioning without any danger of the skin "sticking" to the handle. The surrounding hard zones with large diameters glide like wheels through the hand.

Non-roll feature



The hexagonal non-roll feature prevents any rolling away at the workplace.

Identification marking



The screw symbol and tip size identification markings on the handle make it easier to find the right screwdriver in the tool case, or at the workplace.

Wera Black Point tip

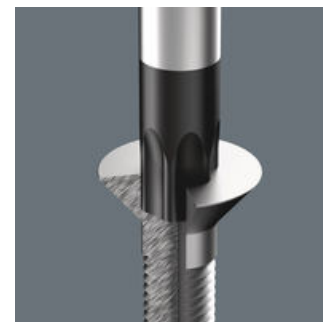

The Wera Black Point tip and a refined hardening process ensure long service life of the tip, improved corrosion protection and an exact fit.





Web link

https://products.wera.de/en/screwdrivers_kraftform_plus_series_300_367_torx_bo.html

Wera - 367 TORX® B0
05138258001 - 4013288039972

Wera Werkzeuge GmbH
Korzter Straße 21-25
D-42349 Wuppertal
Tel: +49 (0)2 02 / 40 45-0
E-Mail: info@wera.de

Further versions in this product family:

		 mm	 mm	 mm	 inch
05138257001	TX 7	60	70	3.5	2 3/8"
05138258001	TX 8	60	81	3.5	2 3/8"
05138259001	TX 9	60	81	4.0	2 3/8"
05138260001	TX 10	80	81	4.0	3 1/8"
05138268001	TX 10	300	81	4.0	12"
05138261001	TX 15	80	98	4.0	3 1/8"
05138269001	TX 15	300	98	4.0	12"
05138262001	TX 20	100	98	4.5	4"
05138270001	TX 20	300	98	4.5	12"
05138263001	TX 25	100	105	5.0	4"
05138264001	TX 27	115	105	5.5	4 9/16"
05138265001	TX 30	115	105	6.0	4 9/16"
05138266001	TX 40	130	112	7.0	5 3/16"

Web link

https://products.wera.de/en/screwdrivers_kraftform_plus_series_300_367_torx_bo.html

Wera - 367 TORX® B0
05138258001 - 4013288039972

Wera Werkzeuge GmbH
Korzter Straße 21-25
D-42349 Wuppertal
Tel: +49 (0)2 02 / 40 45-0
E-Mail: info@wera.de