

# iGrow 100 Series™

990-0800-02



## Installation and User's Manual

960-2010-00A

Feb 2021 v5.5a Edition  
Copyright 2021 **Link4** Corporation

# Table of Contents

Introduction .....	1
Customer Service .....	2
Contact Us .....	2
Terms and Conditions .....	3
Limited Warranty .....	3
Return, Exchange, or Refund.....	4
Returns .....	4
Repairs .....	4
Additional Costs .....	4
Governing Law .....	4
Support .....	4
Before you Begin .....	5
Temperature Control .....	5
Deadbands .....	6
Setpoints .....	6
Ramping .....	6
Sample Worksheet .....	7
Control Strategy .....	8
Setpoint and Staging Worksheets .....	8
Hardware Installation .....	9
Content Inspection .....	9
Recommended Tools .....	9
Mounting the iGrow 100 Series™ .....	9
iGrow 100 Series™ Overview .....	11
Opening the iGrow 100 Series™ .....	11
Internal Layout .....	12
Wiring the iGrow 100 Series™ .....	13

Power Supply Installation .....	13
Output Installation .....	14
Control Relays and Contractors .....	15
“Dry” Contact Design .....	15
Indoor Air Temperature Probe Installation .....	16
Programming .....	18
Before You Begin .....	18
iGrow 100 Series™ Main Screen Layout .....	18
Navigation .....	19
Status Screens .....	20
Main Status Screens .....	20
Programming Screens .....	21
Setpoint Programming .....	22
Reports .....	27
Return on Investment .....	28
Graphing .....	29
Equipment Costs .....	33
Energy Costs .....	34
Equipment Usage .....	35
Energy Usage .....	36
Event Logs .....	37
System Setup .....	39
Equipment Setup .....	40
General Type .....	43
Energy Type .....	49
Assign Stages .....	54
Temperature Stages .....	55
Humidity Stages .....	57
Reset Runtime .....	59
Save and Restore .....	60

Save and Restore Configurations .....	61
Save Log Files .....	63
Sensor Setup .....	65
Map Sensors .....	66
Calibrate Sensors .....	67
Self-Test Set Up .....	68
Analog Sensor Mapping .....	69
Time and Date Setup .....	70
Set Time .....	71
Set Date .....	72
Location Setup .....	73
Energy Cost .....	74
Communication Setup .....	77
Weather Station Setup .....	78
IP Address Setup .....	79
Measurement Units .....	80
Advanced .....	81
Humidity Settings .....	82
ROI Settings .....	83
Clear All Data .....	83
Unit Info .....	83
Stage Delay .....	84
Bump Off Time .....	84
Begin Bootload .....	84
UI Test .....	85
Password .....	85
Stages/Staging .....	86
Complete Menu Structure Listing .....	87
Resetting the Controller .....	104

# Introduction

Welcome to iGrow 100 Series™, Link4's Intelligent Greenhouse Environmental Controller.

The iGrow 100 Series™ represents the latest in greenhouse environmental control automation. iGrow 100 Series™ enables you to control and integrate a variety of equipment in your greenhouse. Your heating, cooling, venting, shading, humidity, CO<sup>2</sup>, and lighting needs are linked together into one flexible, easy-to-use system.

Link4 can offer reliable service because we are staffed by the designer and engineers that developed the iGrow 100 Series™. In designing the iGrow 100 Series™ it was our purpose to design a controller specifically for the demands and cost concerns for small to mid-size growers and no other controller has a better feature to price ratio than iGrow 100 Series™. Your greenhouse control system should improve the quality and efficiency of your operation. iGrow 100 Series™ offers quick installation, and dynamic programming flexibility for easier and more accurate greenhouse management giving you the freedom for you to focus on plants and profits.

The reason why we stand out from others is because of our Link4 Promise: Our passion is to provide growers with intelligent control solutions. We understand controlling your growing environment is critical to your success. Therefore, our commitment is to build outstanding controllers and to provide excellent support so that you can know with confidence that the iGrow 100 Series™ system is right for you.

# Customer Service

Link4 has a well-trained customer support staff that is ready to help. Our customer service center is committed to your greenhouse business 24/7 through our website or service line for access to solutions for your controller needs.

## Contact Us

**Address:**

Link4 Corporation  
175 East Freedom Avenue,  
Anaheim, CA 92801

**Website:**

<http://www.link4controls.com>

**Telephone:**

**Main Telephone:** (714) 524-0004  
**Toll Free:** (866) 755-5465  
**Customer Service:** (714) 975-9474  
**Facsimile:** (714) 854-7244

**Email:**

**Sales:** sales@link4corp.com  
**Service:** support@link4corp.com

# Terms and Conditions

## Limited Warranty

Link4 warrants that the goods sold will be free from defects in material and workmanship for a period of 12 months after the date of purchase. This warranty will be limited to the repair and replacement of parts and the necessary labor and services required to repair the goods. IT IS EXPRESSLY AGREED THAT THIS WARRANTY WILL BE IN LIEU OF ALL WARRANTIES OF FITNESS AND IN LIEU OF THE WARRANTY OF MERCHANTABILITY.

Moreover, any description of the goods contained in this Installation and User's Guide is for the sole purpose of identifying them, is not part of the basis of the bargain, and does not constitute a warranty that the goods will conform to that description. The use of any sample or model in connection with this Installation and User's Guide is for illustrative purposes only, is not part of the basis of the bargain, and is not to be construed as a warranty that the goods will conform to the sample or model. No affirmation of fact or promise made by Link4, whether in this Installation and User's Guide, will constitute a warranty that the goods will conform to the affirmation or promise.

Link4 shall not be responsible for replacement(s) or repair(s), which become defective from user negligence, modification, abuse, any types of improper usage, acts of God and/or force majeure. Nonconformance to any of the specifications in the product manual will void the warranty. Furthermore, Link4's liability to the goods sold, whether on warranty, contract, or negligence, will be released upon the expiration of the warranty period when all such liability shall terminate. Link4 shall not be responsible for any loss or claims due to consequential damages caused by the Buyer. Link4 also reserves the right to make any necessary changes to features and specifications, and to the terms and conditions of this warranty.

Notwithstanding any provision hereof which may be or appear to be to the contrary, in no event whatsoever shall Link4 Corporation's liability in respect to any claim or action of any kind arising out of, in connection with, or resulting from the manufacture, sale, delivery, resale, use or repair of the goods or component parts thereof or the services rendered by Link4 Corporation pursuant to the agreement, or any breach by Link4 Corporation of any term of the agreement, exceed the price for the goods or component part thereof or service which gives rise to such claim or action. Customer assumes all other liability for any loss, damage or injury to persons or property arising out of, connected with or resulting from the use of the goods, either alone or in combination with other products, including, without limitation, any "special damages" or any loss, damage or injury to customer (or to customer's employees or property or to the employees or property of any customer of customer or other user of the goods) due to the acts or omissions of customer, its agents, employees or customers, in the installation, maintenance, use or operation of such goods.

# Return, Exchange, or Refund

## Returns

Merchandise cannot be returned without a Return Merchandise Authorization (RMA) number from Link4. Requests for permission to return defective items must be made within (14) fourteen days after receipt of shipment. A Link4 RMA number for approved returns must appear on both the customer's shipping carton and the related receipt memo. Parts under warranty will be repaired at no charge. Other returned items will be subjected to the following restocking charges: 20% for no value-added items, 40% for value added items, and 75% for custom designed or built to specification items.

## Repairs

A repair order must also have a Link4 Return Merchandise Authorization (RMA) number. Repairs that are not covered by the warranty will be billed on a material and labor basis. Items returned for repair must be sent to Link4 with prepaid return transportation Link4 will not be responsible for damage(s) due to improper packaging or shipping and delivery of items returned for repair.

## Additional Costs

It is expressly agreed that Buyer will reimburse Link4 for an additional costs attributable to changes in the specifications, directions, or design of the items furnished which are requested or approved by Buyer at Link4's listed retail prices in effect at the time such changes are ordered.

## Governing Law

The validity of this contract and of any of its terms or provisions, as well as the rights and duties of the parties under this contract, shall be construed pursuant to and in accordance with the law of the State of California. The parties specifically agree to submit to the jurisdiction of the courts of the State of California.

## Support

In order to offer you the best support, we request that you register your product with us online at [www.link4corp.com](http://www.link4corp.com). You will find the Register selection under the Support tab of the website.



# Before You Begin

## Temperature Control

With the iGrow 100 Series™ you can program a cooling temperature target called a "Cool Setpoint" and a heating temperature target called a "Heat Setpoint". The temperature range between these two targets is called the "Normal" temperature range or stage. If the greenhouse temperature is within the Normal temperature band usually none of the cooling or heating equipment is on. However, some circulation fans (often called horizontal air flow (HAF) fans) may be active to maintain air movement within the greenhouse environment.

Whenever the temperature within the greenhouse moves above the cool setpoint, or below the heat setpoint (falls outside the Normal temperature range) the iGrow 100 Series™ will enter cooling or heating stages to bring it back in line. With the iGrow 100 Series™ you can program up to six cooling and two heating stages. These stages go from Cool 1 to Cool 6 and Heat 1 to Heat 2. Cool 1 and Heat 1 are the least aggressive with Cool 6 and Heat 2 the most aggressive. In your program you will determine what equipment you want to be active in each of the stages.

When the air temperature in the greenhouse rises above the Cool Setpoint, the system enters the first stage of cooling, referred to as Cool 1. If the temperature continues to rise, the system will enter the second stage, Cool 2, then the third stage, Cool 3 and so forth. At each increasing cooling stage, more cooling will be brought to attempt to bring the air temperature below the cool setpoint and within the target "Normal" temperature range. Heating works the same way.

In considering the difference between each heating and cooling stage there is a variable in the program which is the number of degrees between each heating and cooling stage called the "Stage Separation" or "Stage Width". Whenever the temperature rises above the cool setpoint, the iGrow 100 Series™ will activate the appropriate equipment to bring the greenhouse to the normal temperature range. If the stage width is 1 degree and the temperature rise 1.1 degrees above the cool setpoint, then the controller will be active in C2 cooling stage. The same goes for the heating stage when the temperature drops below the heating setpoints. In Figure 1.1, there is an example with four cooling stages and two heating stages.

## Deadbands

If the temperature is below the cool setpoint and rises into the first stage of cooling, some cooling equipment will be turned on. This may then lower the temperature and bring it into the normal range. To keep the equipment from oscillating, a “Deadband” is employed when the temperature is between stages. In Figure 1.1 the dead band is set at 1 degree so that when the greenhouse is attempting to return to Normal temperature from C4 to C3 the controller will use a deadband of 1 degree to keep the equipment from oscillating off and on. Now, when the temperature drops below the cool setpoint, the system remains in the Cool 1 stage until the temperature drops below the Cool Deadband. The concepts that we described for cooling operate in the same manner for heating.

## Setpoints

You will be able to use up to 3 setpoints in a 24-hour time period. Within each twenty-four-hour period Setpoints are based on time and temperature to produce the desired environment. By placing setpoints during different times of the day you can regulate the temperature within a range for target temperatures and humidity (humidity sensor sold separately). When a setpoint is in effect at a certain time length the controller will activate the necessary equipment in heating and cool stages to bring the environment back to Norm. The same applies when the humidity rises or falls beyond the target low/high setpoint. When one or more setpoints are used the second or subsequent setpoints will become the active setpoint at the start time and the previous setpoint will end.

## Ramping

In addition, you have the option of a temperature ramp between the setpoints. Each set-point period begins with a Ramp time. The benefit of ramping allows you to make smooth transitions within the greenhouse so that the plants do not experience temperature shock. Ramping also saves energy, which translates directly into lower operating costs.

In the example on the following page (Figure 1.1), the start time is 8:00am with a 60-minute ramp time. The ramp time enables a smooth transition of the target temperatures between the setpoint time periods. Of course, the ramp times can be set to 0 and in this case, there will be an immediate step transition in the set points. Figure 1.1 also shows a typical example of a staging worksheet.

# Sample Worksheet

SET POINTS	START TIME	TEMPERATURE		RAMP TIME (min)	HUMIDITY	
		Low Set Pt (°F/°C)	High Set Pt (°F/°C)		Low Set Pt (%)	High Set Pt (%)
DAY	6:00 AM	68	72	30	55	80
NIGHT	7:00 PM	55	65	60	55	80
DIF	NOT USED					

OUTPUTS	EQUIPMENT NAME	FOR ON/OFF & VENT ONLY										HUMIDIFICATION STAGES	
		HEAT STAGES			COOLING STAGES								
		H2	H1	N	C1	C2	C3	C4	C5	C6	De-H	Hum	
1	RVM-1 ROOF VENT OPEN				20%	40%	60%	80%	99%	99%	15%		
2	RVM-1 ROOF VENT CLOSE												
3	SWM-1 SIDEWALL OPEN				0%	10%	80%	99%	99%	99%	0%		
4	SWM-1 SIDEWALL CLOSE												
5	EX-1 EXHAUST FANS							ON	ON	ON	ON		
6	HAF-1 HAF FANS	ON	ON	ON	ON	ON	ON	ON	ON	ON	ON		
7	HT-1 HEAT NORTH	ON	OFF										
8	HT-2 HEAT SOUTH	ON	ON										

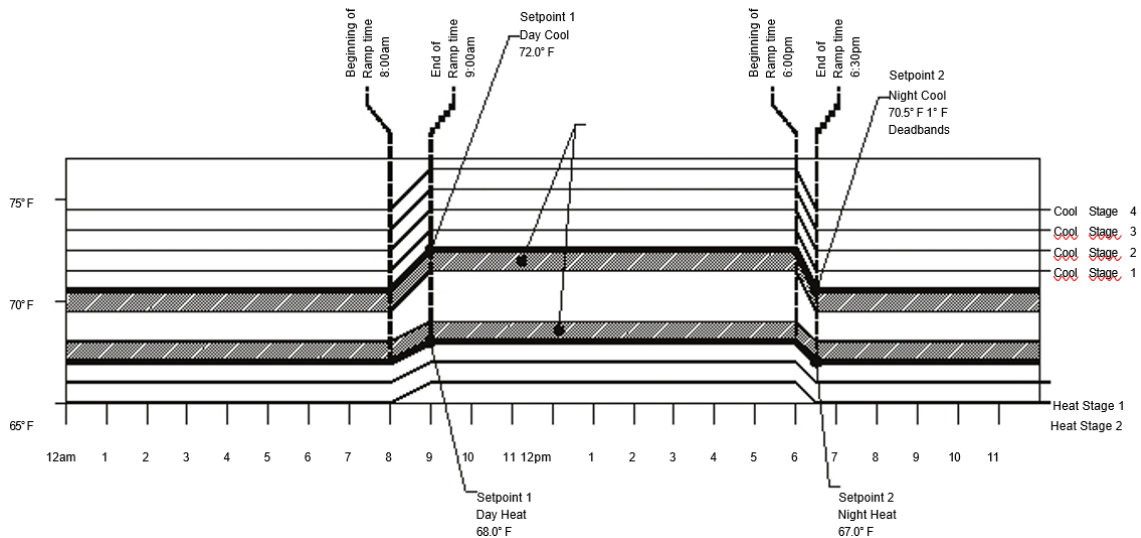

Setpoint 1 is set to 8:00am with a 60minute Ramp, Temp is set as 68 to 72.0°F Setpoint 2 is set to 6:00pm with a 30minute Ramp, Temp is set as 67 to 70.5°F

**Figure 1.1 Example of Setpoints, Staging, and Deadbands**

# Control Strategy

Prior to installing and programming the iGrow 100 Series™ it is important to determine an overall strategy to control the environment in the greenhouse. The iGrow 100 Series™ is an extremely flexible and powerful device, thus additional care and planning are required.

To aid you with the process, Link4 has provided several worksheets in the following pages. It is assumed that you already possess a general understanding of greenhouse controls. If not, please review this section carefully.

It is recommended that you make copies of these sheets before using them. They will be useful in the future should your control needs change.

## Setpoint and Staging Worksheets

SET POINTS	START TIME	TEMPERATURE		RAMP TIME (min)	HUMIDITY	
		Low Set Pt (°F/°C)	High Set Pt (°F/°C)		Low Set Pt (%)	High Set Pt (%)
DAY						
NIGHT						
DIF						

OUTPUTS	EQUIPMENT NAME	FOR ON/OFF & VENT ONLY											
		HEAT STAGES			COOLING STAGES						HUMIDIFICATION STAGES		
		H2	H1	N	C1	C2	C3	C4	C5	C6			
1													
2													
3													
4													
5													
6													
7													
8													

Figure 1.2 Setpoint and Staging Worksheets

# Hardware Installation

## Content Inspection

The package should come complete with an iGrow 100 Series™ unit, a 12 VDC power supply, and 4 - Self Drilling Screws. Upon arrival, check the contents with the packing list for damaged or missing components.

Additional accessories such as digital temperature/humidity sensor, outside temperature sensor, light sensor, temperature sensor probe with 50ft. of cable attached, mounting feet, VC option for shade and vent control, wind and rain sensors can be purchased and added at any time.

Make sure you have all items, all associated hardware, and necessary tools before you begin installation. If there is any visible damage, please contact our customer service at [support@link4corp.com](mailto:support@link4corp.com) or 1-866-755-LINK or fax us at 714-558-9782.

1. iGrow 100 Series™ unit
2. 12 VDC external Power Supply
3. 4 pcs - Philips Head Self Drilling Screws (not included)
4. 4 pcs - 3/8" Drive, Hex Head Self Drilling Screws (integrated option only; not included)

## Recommended Tools

1. Drill
2. 1/8 high speed steel drill bit
3. Philips head screwdriver
4. Level (optional)
5. Pencil

## Mounting the iGrow 100 Series™

1. First, find a secure location to mount the iGrow 100 Series™ controller. The area should be away from direct sunlight, condensing humidity, water, rain, or extreme temperatures. It should be mounted in an easily accessible location at the user's eye level.
2. Since the iGrow 100 Series™ is equipped with a hinged door and a hinged access panel for easy service and installation, make sure there is adequate workspace. The recommended clearance is 8" from each side of the control unit.
3. The iGrow 100 Series™ comes with a 12V DC wall mount power supply. Make sure there is a power outlet within approximately 6 feet. It is recommended that the outlet is not switched and is on a circuit that is independent of any noisy, high power equipment. The use of a sealed outlet is recommended if the power output is exposed to moisture.

4. Identify what type of surface you will be mounting the iGrow 100 Series™ to. Use 4 self-drilling screws for mounting to beam or wood panel.
5. There are 4 mounting points on the inside of the iGrow 100 Series™. Using the appropriate tools depending on your surface, mount the iGrow 100 Series™. Refer to the figure below (2.1) for a visual picture.

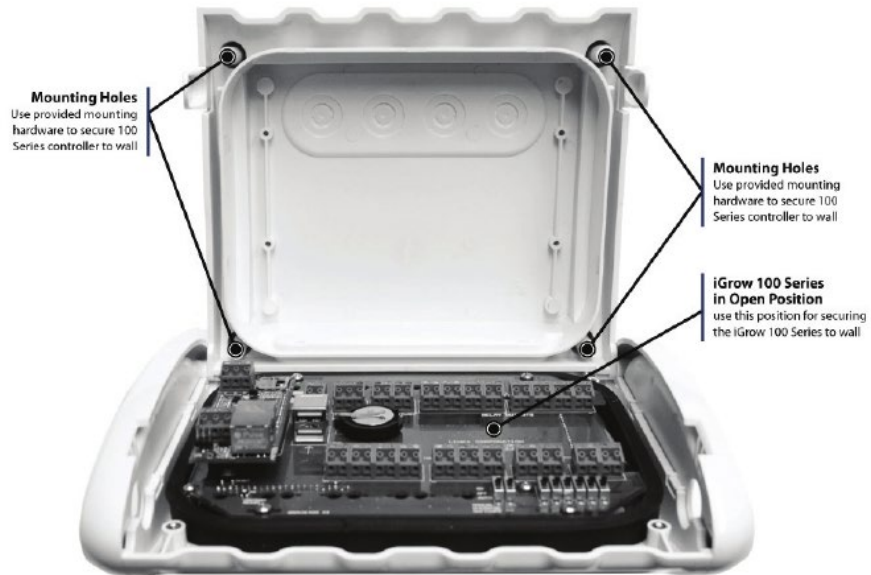

**Figure 2.1 iGrow 100 Series™ Installation Instructions**

# iGrow 100 Series™ Overview

Now that the iGrow 100 Series™ has been mounted, take some time to look over the front panel. The iGrow 100 Series™ has many features to help give you the growing advantage. Figure 2.2 below gives an overview of the main components that the iGrow 100 Series™ has to offer.

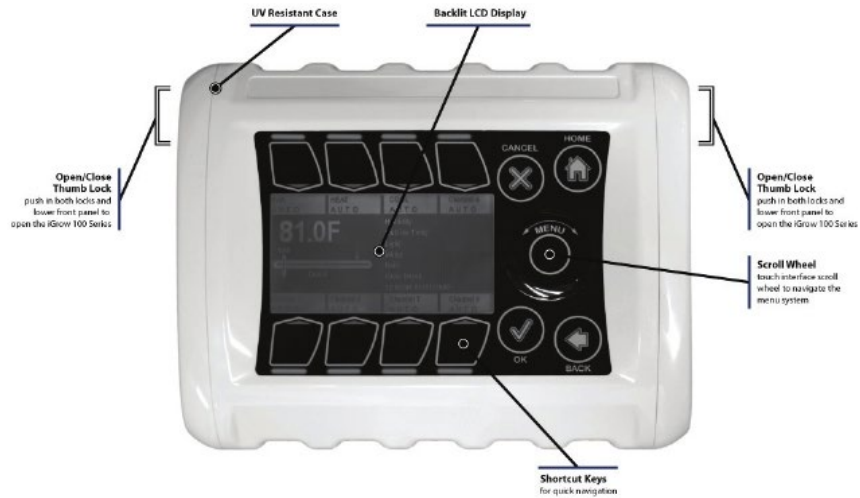

Figure 2.2 Front View of iGrow 100 Series™

## Opening the iGrow 100 Series™

Open the hinged door by simultaneously depressing on the two side ejector buttons with your thumbs, while using your middle and index fingers for support.

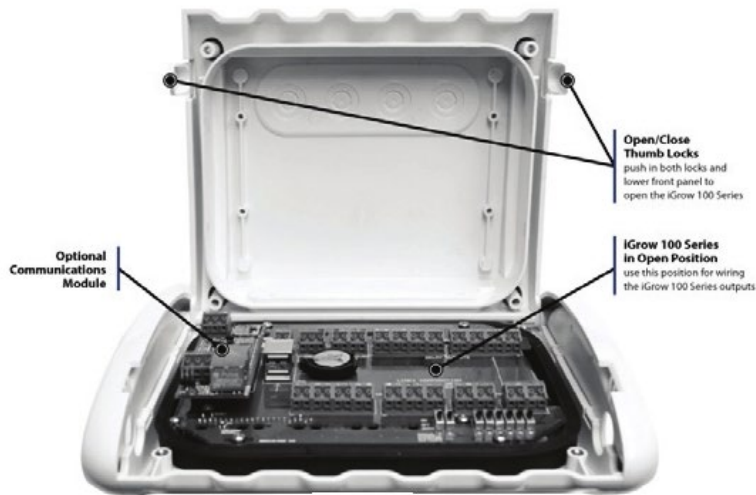

Figure 2.3 proper finger positions for door opening

## Internal Layout

Figure 2.4 shows how the iGrow 100 Series™ looks on the inside. Take notice of the board and familiarize yourself with the internal layout before beginning the wiring process.

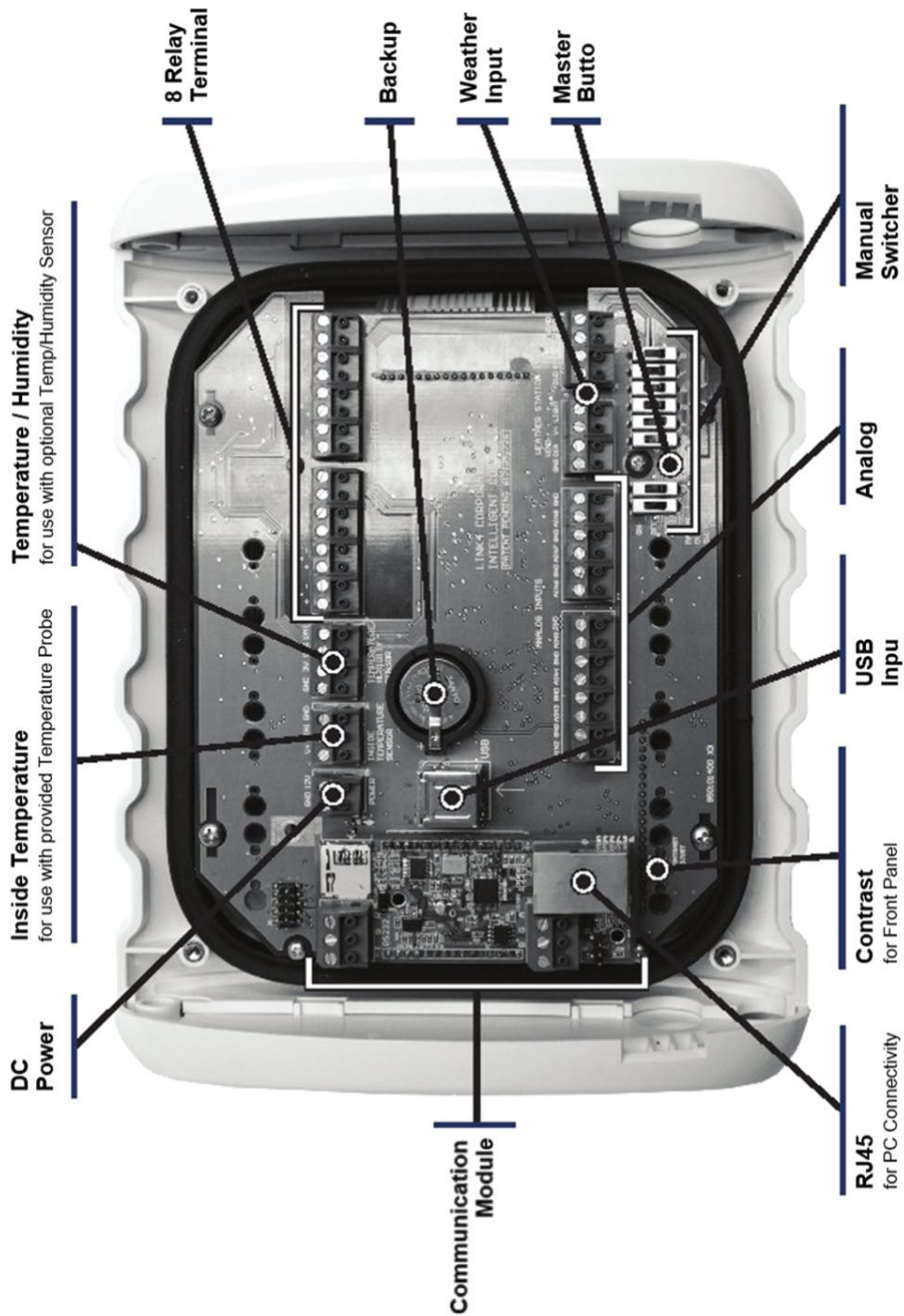

Figure 2.4 Internal Layout of the iGrow 100 Series™ PCB



# Wiring the iGrow 100 Series™

Warning: Do Not Plug-in the Power while wiring the iGrow 100 Series™ and keep the manual override switches in the OFF position.

It is recommended that all connections be made through liquid tight connectors at the bottom of the iGrow 100 Series™. These glands compress around the cables to form a watertight seal. Making any additional holes in the top, sides, or back of the enclosure can result in water condensation inside the unit, causing damage to the controller. Failure to install to Link4's specification will void the warranty.

In preparation for the control wiring you should decide the iGrow 100 Series™ output assignments and control strategy. For more information on output assignment and control strategies, please refer to the Control Strategy section and the appropriate worksheets for this manual.

## Power Supply Installation

1. If you want to navigate through the iGrow 100 Series™ to see some of the features and to familiarize yourself with how it works, begin by installing the power supply. Make sure the power supply is NOT plugged in while installing any other outputs or inputs.
2. Begin the power installation by measuring the distance between where the iGrow 100 Series™ is mounted and the power socket. There needs to be about 6 feet between the two. If the power supply is too short, then use a power extension cord. Note: extension cord is recommended for temporary usage only.
3. Make sure all 8 manual toggle switches are in the OFF position.
4. Take the open end (the two stripped and tinned leads) of the power supply. The RED lead is the 12VDC power and the BLACK lead is the GND (ground). Route the power lead through the left most liquid tight connector. Remember not to plug in the power supply at this time.
5. Locate the DC Input Power terminal on the PCB. See Figure 2.4 and Figure 3.1.
6. Connect the Ground lead (BLACK) to the GND terminal using a #0 screwdriver. Make sure to make it a snug fit. Also take care not to over-tighten the connection.
7. The same process is used to connect the 12V power lead (RED) to the 12V terminal using a #0 flat drive screwdriver.
8. Now, if needed, you can plug in the power to navigate through the iGrow 100 Series™. If you continue to install different outputs or inputs remember to keep the power supply unplugged.

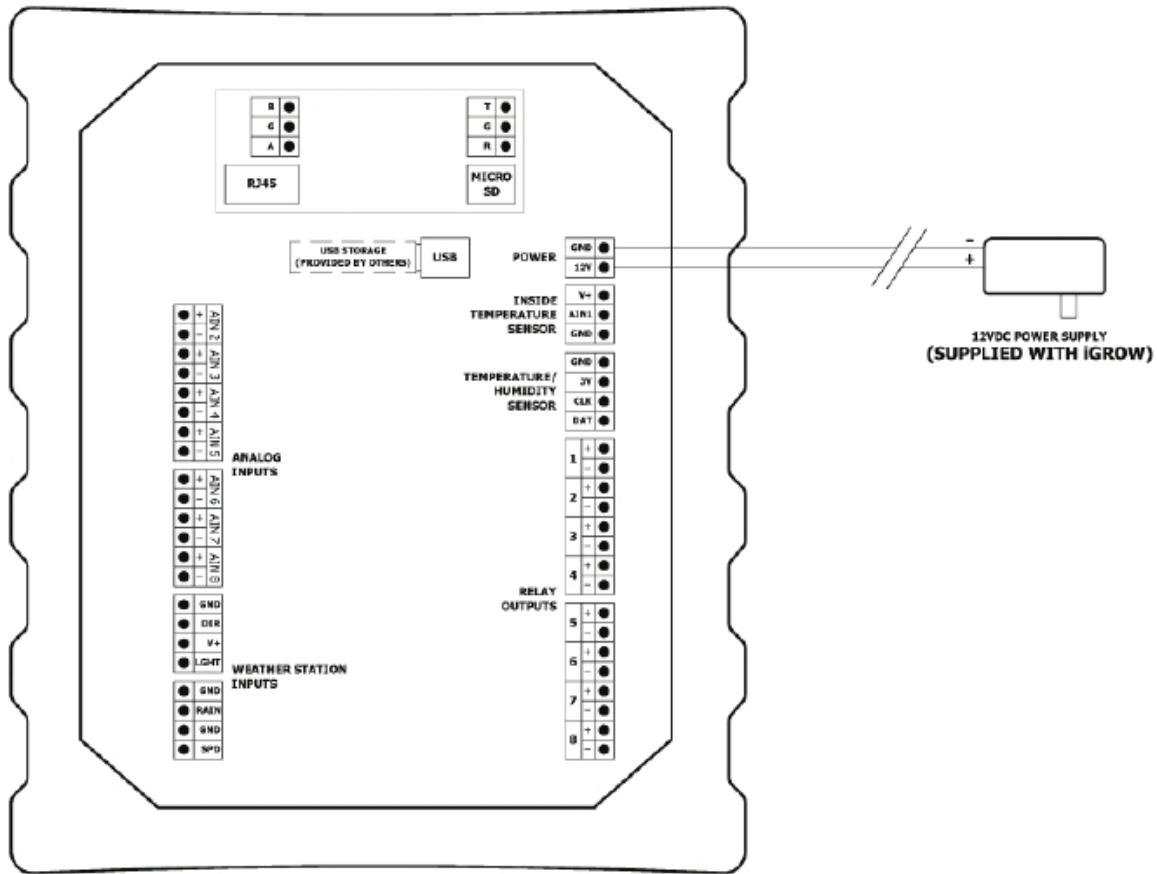

**Figure 3.1 Wiring the Power Supply**

## Output Installation

The general installation strategy for this section is to install the output equipment in the greenhouse first and then the inputs to keep the cables organized in the iGrow 100 Series™. It is assumed that at this point you have already planned the channel assignment.

If you have not, please refer back to Control Strategy (page 9).

All cables coming into and out of the iGrow 100 Series™ should go through the liquid tight connectors at the bottom of the enclosure. To minimize interference, it is recommended that the sensor input wires not be routed through the same connector as the control power. For best results, route all sensor wires through the left most liquid tight connector and then move toward the right. The power wires and non-sensor wires are routed through the right most connector, and if needed, the next connector over.

## Control Relays & Contactors

Your iGrow 100 Series™ has 4 or 8 output relays that are provided as dry contacts, i.e. switch closures. If an output is activated to ON, the switch is "closed" (shorted); and if it is activated to OFF, the switch is "open" (no continuity between the positive and negative terminals).

The board mounted relays are intended as "pilot" relays. For most loads you will want the iGrow 100 Series™ outputs to control a load relay or contactor that is connected to the motor. However, in some cases such as irrigation valves that are 24 VACS, you can drive them directly assuming that you are wiring only one or two valves per relay. The maximum run current recommended for each of the iGrow 100 Series™ relays is 1 amp.

**The maximum voltage the relays can switch is 24VAC or DC.**

## "Dry" Contact Design

"Dry" contact installation design is used when a user wants to isolate equipment and use transformers for every piece of equipment.

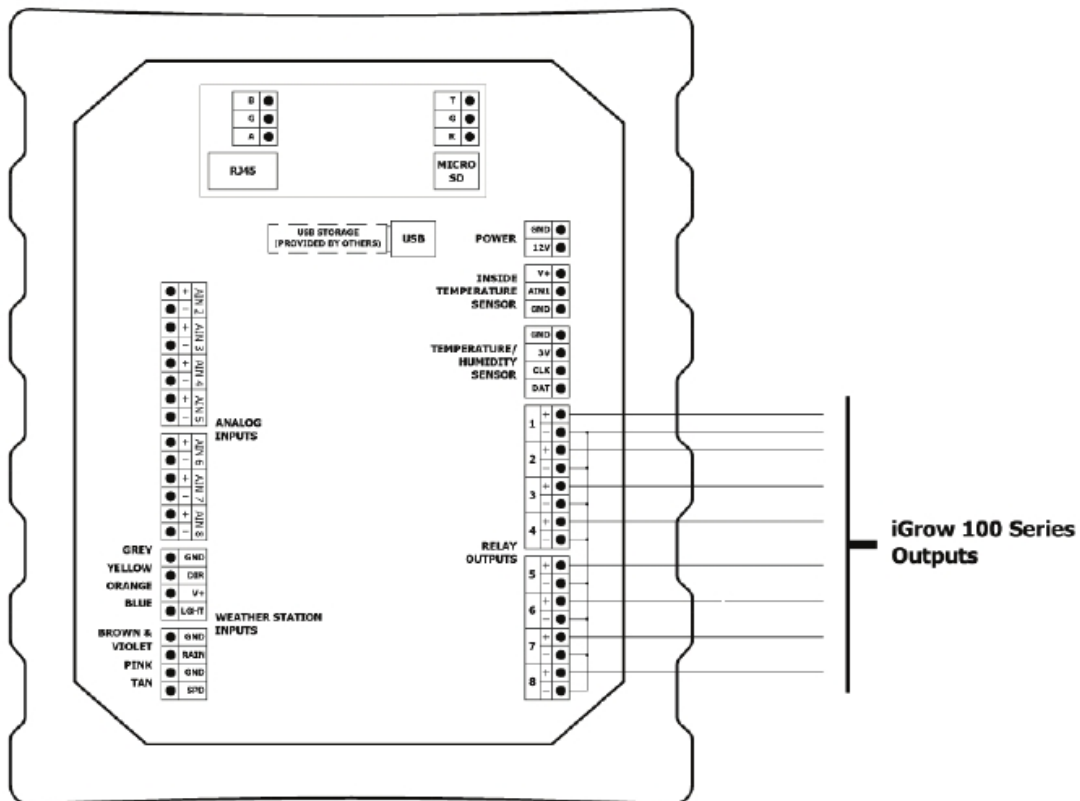

Figure 3.2 Output Wiring Example

## Indoor Air Temperature Probe Installation

The iGrow 100 Series™ is not shipped with a standard temperature probe. It is an additional accessory that can be purchased at any time. If you did not purchase a temperature probe, please skip to page 18. This sensor includes 50-feet of sensor cable. Normally you will want to hang the sensor near the crop level close to the center of the controlled environment. It is important to keep the sensor away from irrigation emitters, unit heaters, etc. that will affect the accuracy of the sensor.

1. First, open the front door, as shown in Figure 2.3.
2. Find a central location in the greenhouse and let it hang relatively close to the height of where the plants will be.
3. Run the free end of the sensor cable to the controller unit.
4. You may extend the sensor cable as needed, but make sure to use an adapter and wire approved by Link4 to make any extensions (the wire and adapter can be purchased from Link4). It should be noted that the controller is calibrated for a 50 ft. temperature probe. If additional wires are added or removed, software calibration will be necessary to ensure proper temperature measurement accuracy.
5. Carefully insert the cable through the right most watertight fitting at the bottom of the enclosure. It is easy to strip insulation and/or break wires when pulling cable. If you want to bundle wires tighter, use UV protected "tie wraps" (typically blue or black), and do not over-tighten.

<p><b>NOTE:</b> If any splices are needed to extend cable length, make certain they are WATERTIGHT. Water or fertilizer infiltration WILL cause unstable sensor readings.</p>
---

6. Connect the wires as shown in Figure 3.3.
7. Keep sensor cables away from interference sources, including high voltage power wiring, inverters, motor controllers, mercury arc, or sodium lamp circuits. Placing sensor cable near such wiring may cause erratic sensor readings.
8. After installing the sensor, it is recommended that sensors be checked by plugging in the power supply and testing under various conditions before moving on to make sure the sensor works properly and accurately. Test the temperature by changing the indoor temperature to see if it is reading properly. After testing remember to unplug the unit to continue installing other sensors.

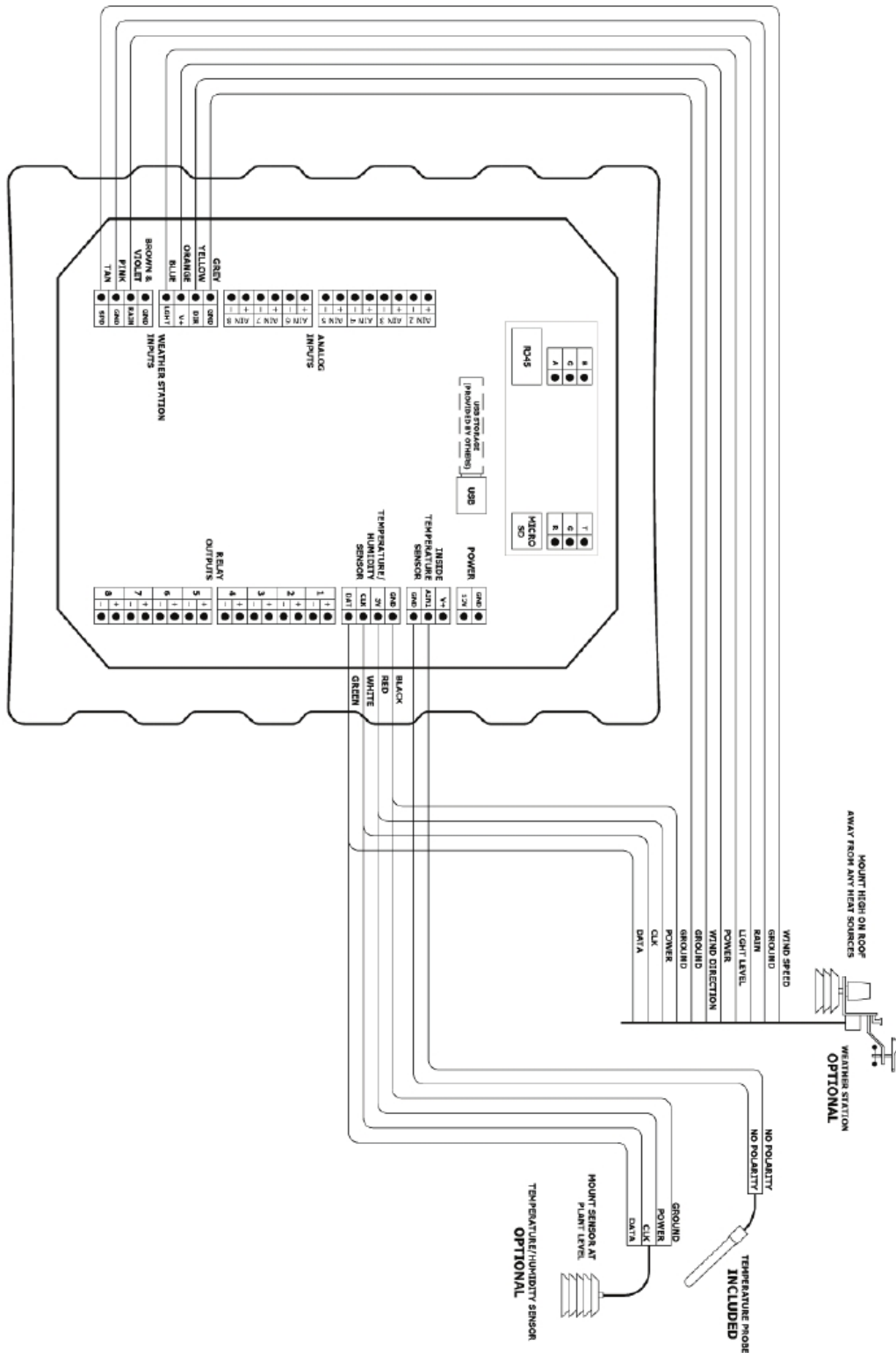

Figure 3.3 Wiring iGrow 100 Series™ Sensors

# Programming

## Before You Begin

Before the iGrow 100 Series™ is programmed, it is recommended that the following steps are followed:

- Hardware is properly installed and tested with manual switches.
- All internal switches have been restored back to the OFF state.
- All the templates from the Control Strategy chapter that are relevant to your application are understood and are filled out.

## iGrow 100 Series™ Main Screen Layout

**NOTE:** The ROI screen would only appear at this level once the energy information has been programmed.

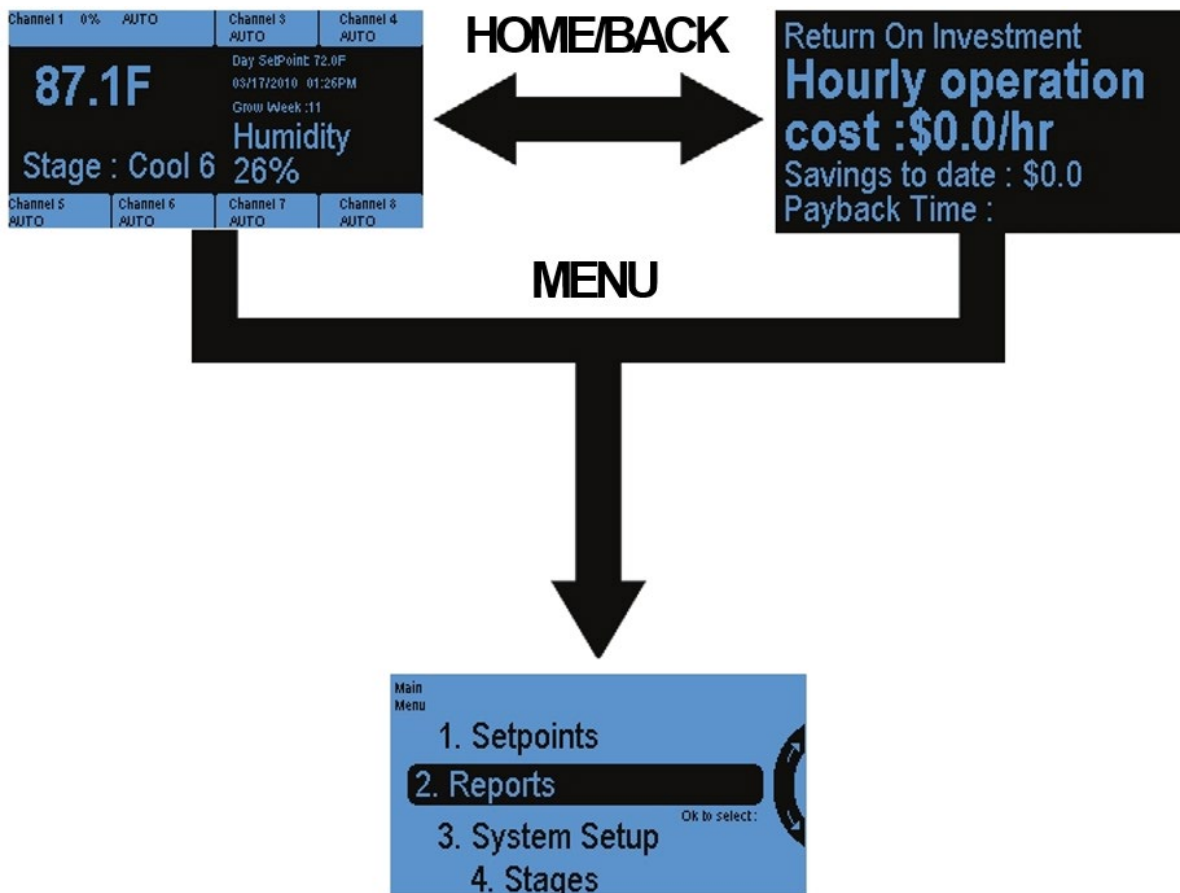

## Navigation

The iGrow 100 Series™ has a unique touch sensitive navigation design that utilizes a touch wheel and 4 navigational touch sensitive "buttons" (HOME, CANCEL, OK, BACK).

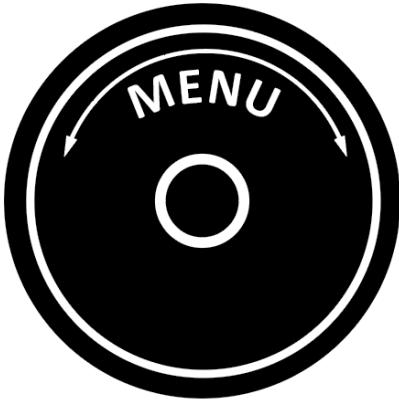

On menu type screens, the wheel is used to rotate the selected choices. The wheel is used as scroll to select different options

It can be used to increase or decrease numeric values.

*Note that the center of the wheel is not a button.*



Pressing **HOME** will bring the unit back to the Main screen.

If data saving might be required, user will be prompted for input.



Pressing **CANCEL** in the middle on an entry will bring the user back up a level, without making any changes.



User can select any option by pressing OK.

Pressing **OK** will prompt the system to accept the most recent data entry.



**BACK** will bring the user back up one level. *User will be prompted to save data, if needed.*

There are also eight "soft buttons" surrounding the display. Their behaviors are contextual and will be described the notations displayed either below or above the buttons.

*Note that the display area itself is not touch sensitive.*

## Status Screens

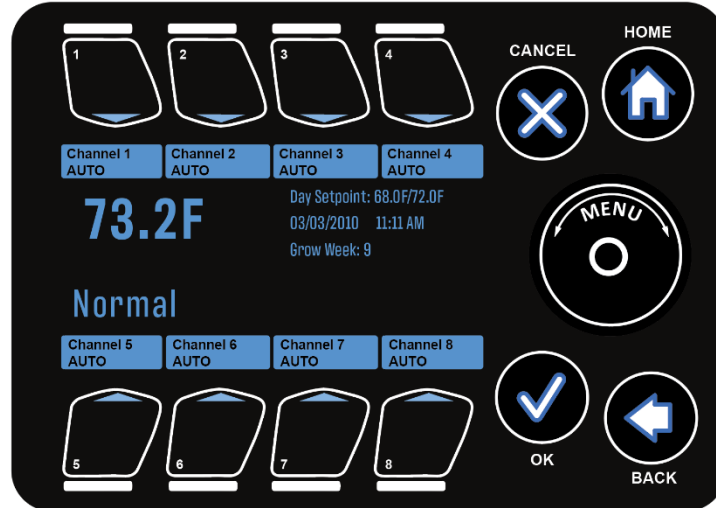

## Main Status Screens

The main status screen displays the current status of your greenhouse zone. The numbers shown are only sample numbers and will differ for each user, but a description for each display will be explained.

- Normal: This is the current temperature stage. It can go from Cool 6, to Normal, to Heat 2.
- Day Setpoint: This is the current setpoint for heating, cooling or normal. For example, if the device is in cool stage, it will show the cool setpoint. In the similar way it would show the heat setpoint. For the Normal stage both the heat and cool setpoints are shown.
- The large 73.2F displayed is the current indoor temperature reading from the indoor temperature sensor.
- Humidity: This is the current relative humidity reading in the zone. Note that this reading is only valid if the optional digital temperature/humidity probe is installed.

For each of the outputs, the equipment's name is displayed, as well as the current controlled state that it is in:

- AUTO: equipment is being automatically controlled by the iGrow controller
- OFF: equipment is being manually FORCED to OFF through software.
- ON: equipment is being manually FORCED to ON through software.

The software output override can be activated by touching the CANCEL respective button above or below the channel.

*The controller also has manual mechanical override switches inside the unit. These switches need to be in the AUTO position. If they are used to force the output OFF or ON, they will override all software settings.*



## Programming Screens

Once the user scrolls on the wheel or presses OK button, the following four choices will be displayed:

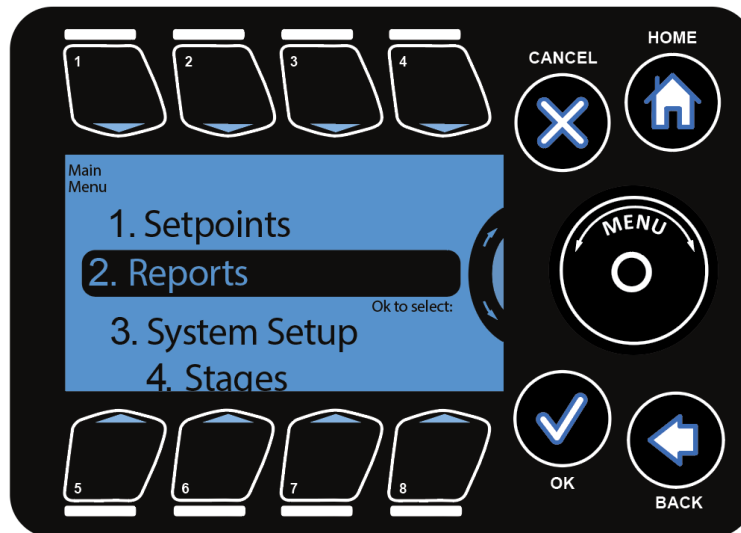

- **Setpoints:** This is where the user can change the temperature and humidity setpoints.
- **Reports:** A variety of data can be graphed and viewed here.
- **System Setup:** Initial programming and advance parameters are set here
- **Stages:** Stage setup is done here.

The following pages describe some programming scenarios. There is also a complete menu listing at the end of the manual.

# Setpoint Programming

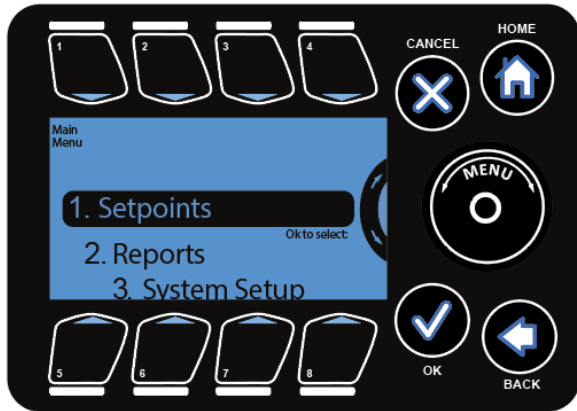

Setpoint programming allows the user to program three different setpoints for temperature and humidity.

The Setpoints Menu can be entered by highlighting the Setpoints option on Main Menu using the **Wheel** or **Button #1** and pressing **OK**.

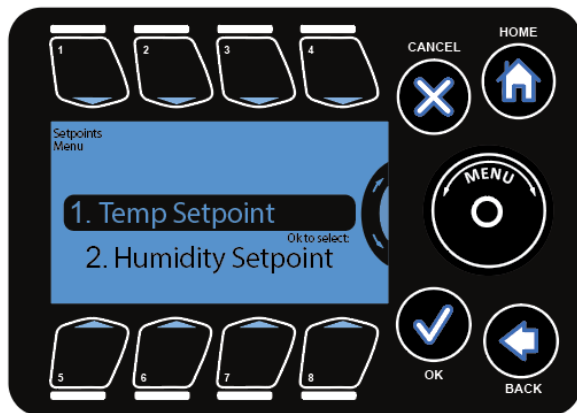

Setpoint programming is divided between temperature and humidity.

User can highlight the Setpoint submenu using **wheel**.

User can select the option by pressing **OK**.

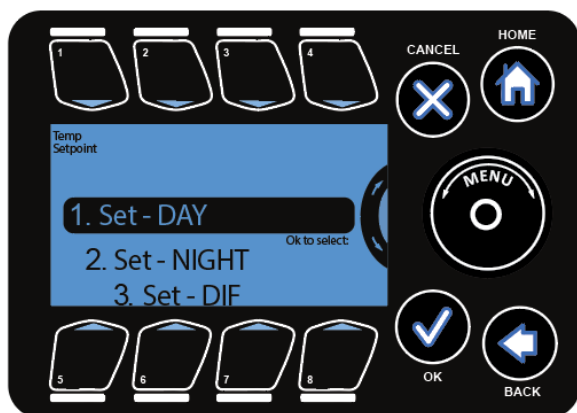

There are three options in temperature and humidity setpoints

- DAY
- NIGHT
- DIF

DAY is active by default. NIGHT and DIF can be turned on if desired.

To select Day, **Wheel**, or **Button #1** can be used to highlight Day option. Similarly, use Button 2, 3 for night and DIF option.

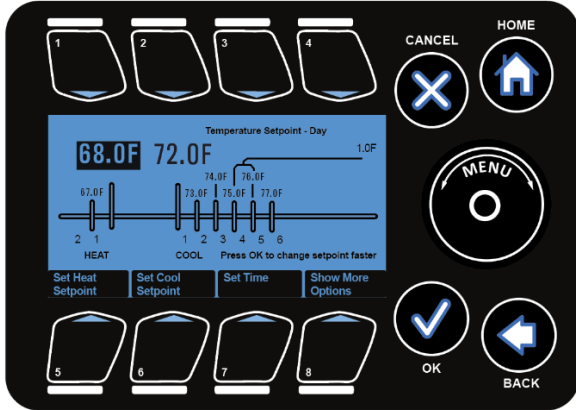

This brings you to the Basic setpoint menu system.

Pressing **Button #6** allows the user to modify the Heat setpoint.

The user can change the temp using the wheel. Similarly, the user can change the cool setpoint by pressing on **Button #7**.

The Heat Setpoint is the low temperature target below which the heat stages are engaged and the Cool Setpoint is the high temperature target above which the cooling stages are invoked.

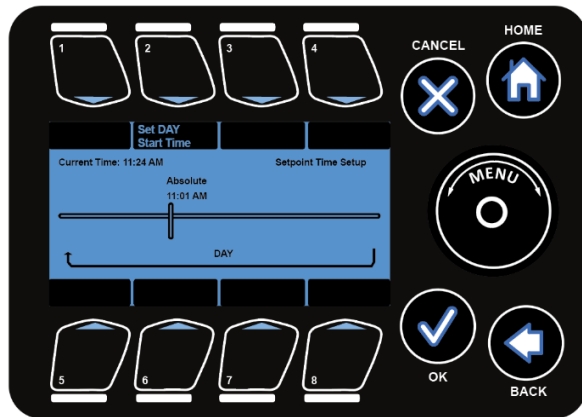

Pressing **Set Time (Button #7)** and then **Set DAY Start Time (Button #2)** will allow the start time for the Day Time Setpoint to be set.

The **menu wheel** can be used to increase or decrease each highlighted value.

*Note that there is only one start time indicated, since the night and DIF setpoint has not been programmed yet.*

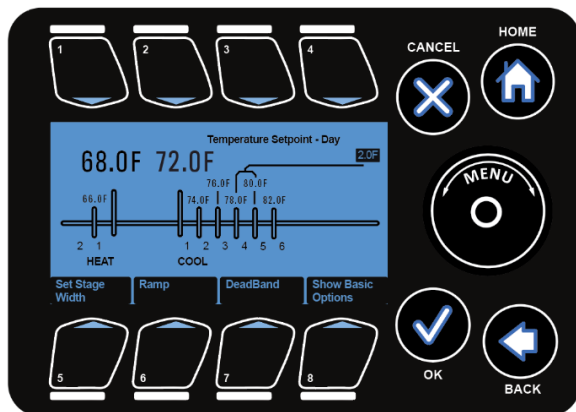

The Stage Separation is the temperature spacing between the stages.

Show more options (**Button #8**) will let the user go to advanced settings. **Button #5** can be used to set stage width. **Wheel** can be used to change temperature spacing

For example, when the temperature in the zone goes above the cool setpoint, the system will go into Cool 1. If the temperature continues to rise and goes above the Cool Setpoint + the Stage Separation temperature, the system will go into Cool 2, and so forth.

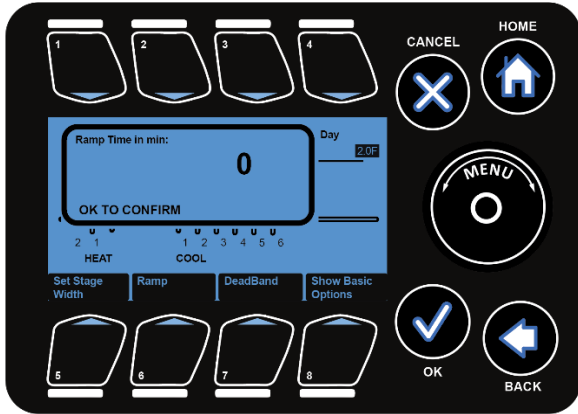

**Button #8** toggles between **Basic** and **Advanced** setpoint menus.

**Ramp** (in minutes) enables a gradual temperature transition from one setpoint to the next. **Button #6** can be used to go to Ramp option.

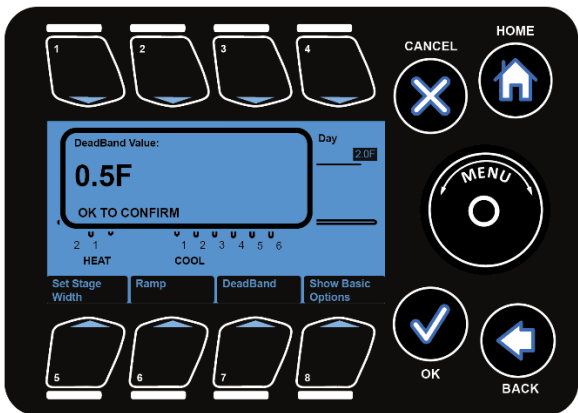

**Deadband** creates a hysteresis in switch temperature which prevents the adjacent stages to oscillate back and forth from small temperature fluctuations. **Button #7** can be used to go to Deadband. **Wheel** can be used to increase or decrease the corresponding value.

Press the **Back** button to navigate back to the Temp Setpoints screen and set the **NIGHT** setpoint.

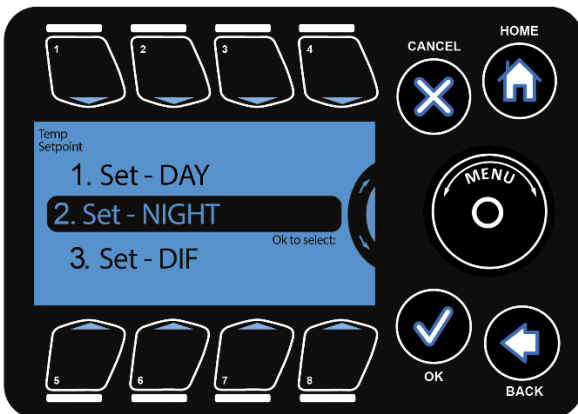

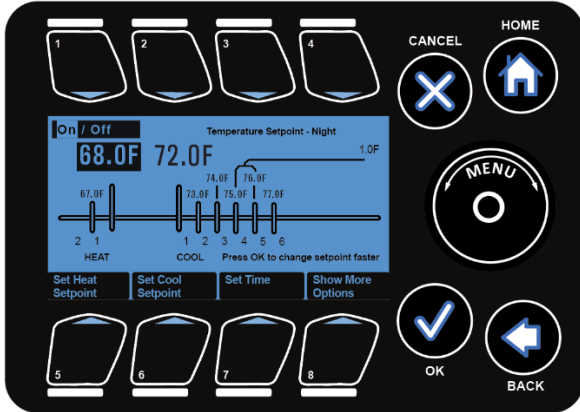

By default, the **Night** and **DIF** setpoints are set to OFF.

Pressing **Button #1** will let the user to turn this parameter On or Off.

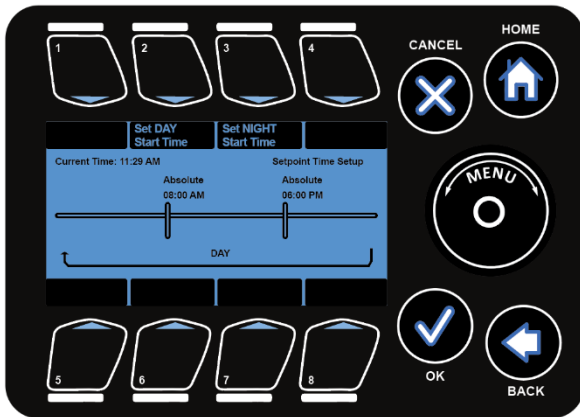

Pressing **Set Time** will allow the user to set the start time for the Night Setpoint.

Note that both Day and Night Times are being displayed now.

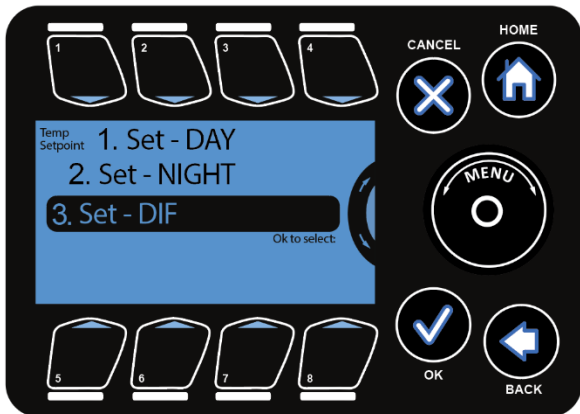

In the same manner, the **DIF** setpoint can be selected and modified.

Other than the ability to switch the NIGHT and DIF Setpoints on and off, they behave similarly to the DAY Setpoint.

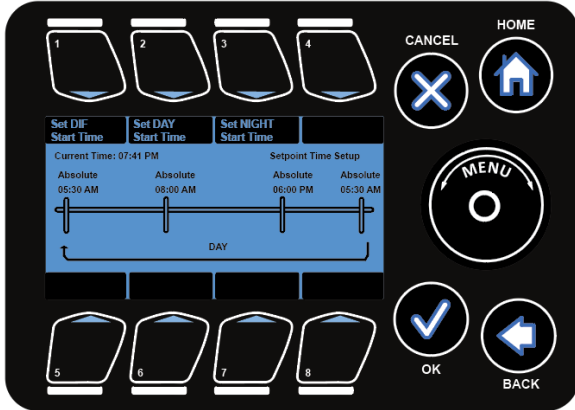

Corresponding Diagram shows when day, night and DIF options are activated.

Note that there are now three start times being displayed, which can be modified as needed.

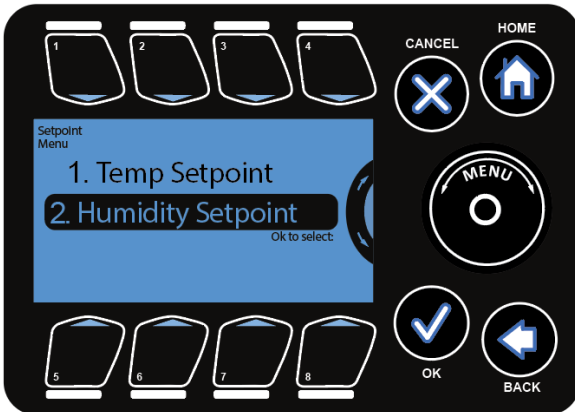

This is an optional feature requiring a humidity sensor.

The same process can be used to modify the humidity setpoints.

Note that the start and end times are the same for Temperature Setpoints and Humidity Setpoints.

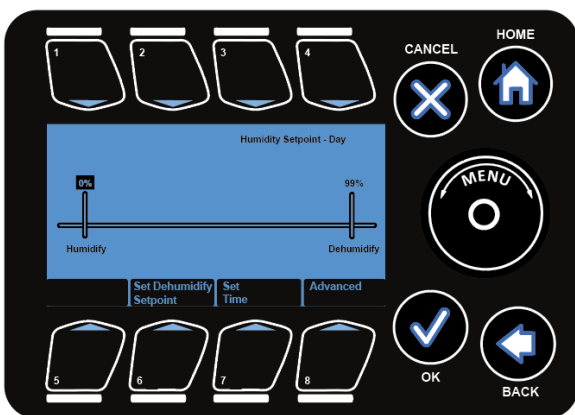

There are two parameters for each humidity setpoint:

**Humidify** - if the RH reading is below this parameter, the condition is considered too dry, and the system will go into the humidification stage.

**Dehumidify** - if the RH reading is above this parameter, the condition is considered too damp, and the system will go into the dehumidification stage.

# Reports

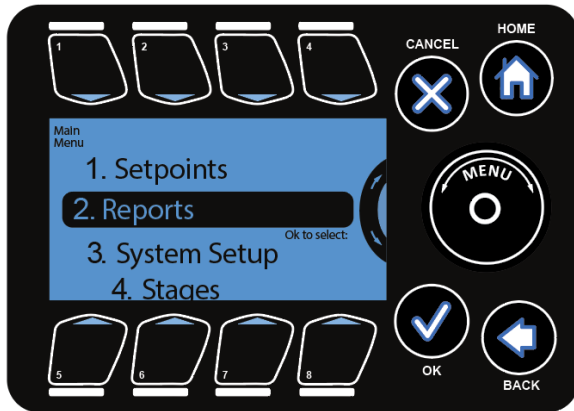

The second main section of the iGrow 100 Series™ controller is the Reports section. This section provides a brief overview of the options available.

This section gives the reports and graphs of energy and equipment usage as well as operational costs.

User can go to reports submenu by pressing **OK**.

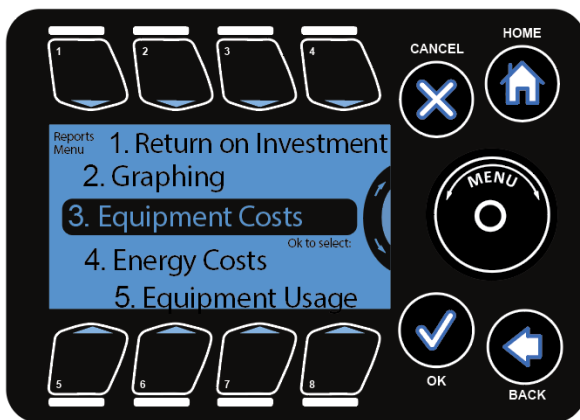

There are 7 subsections under Reports:

1. Return on Investment
2. Graphing
3. Equipment Costs
4. Energy Costs
5. Equipment Usage
6. Energy Usage
7. Event Logs

To highlight the sub options **Wheel** or **Buttons #1 - #7** can be used to go to the corresponding options. Pressing **OK** will let user select the options

# Return on Investment

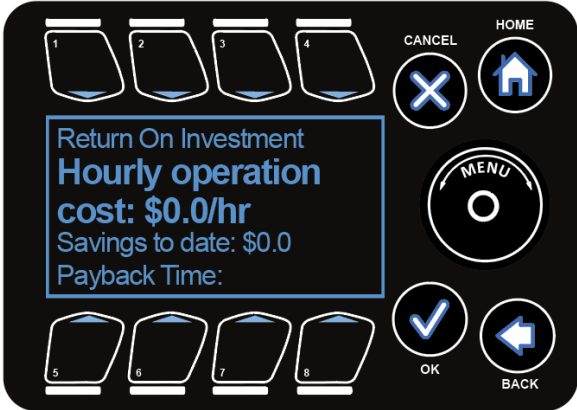

This section allows the user to review the return on investment.

**Button #1** can be used to access this option.



## Graphing

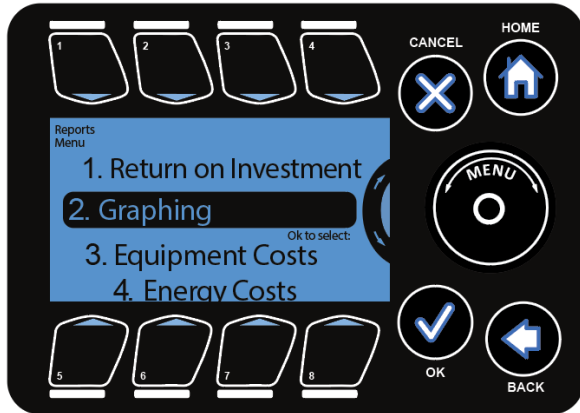

This section allows the user to view graphs for different variables against time.

Pressing **Button #2** from Repots submenu will take the user to graphing submenu.

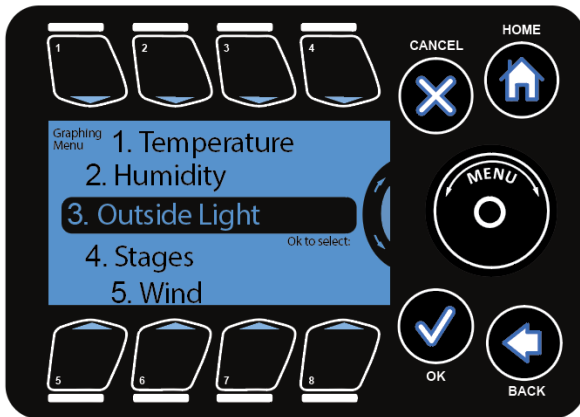

The graphs for the following time periods can be seen:

- Temperature
- Humidity
- Light
- Stages
- Wind
- Rain
- Relay Outputs
- Equipment Status

To highlight the sub options **Wheel** or **Buttons #1 - #8** can be used to go to the corresponding options. Pressing **OK** will let user select the options.

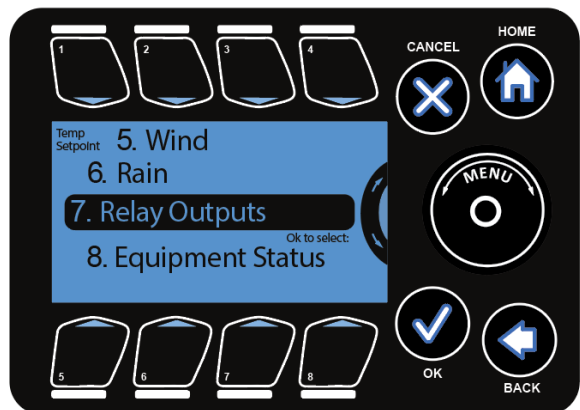

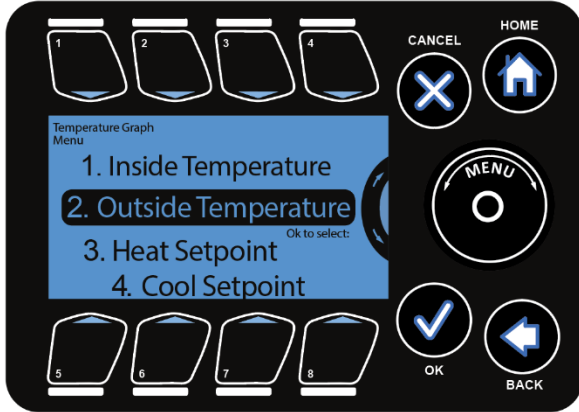

## Temperature

In the temperature option user can view graphs for the following:

- Inside Temperature
- Outside Temperature
- Heat Setpoint
- Cool Setpoint

To highlight the sub options **Wheel** or **Buttons #1 - #4** can be used to go to the corresponding options. Pressing **OK** will let user select the options.

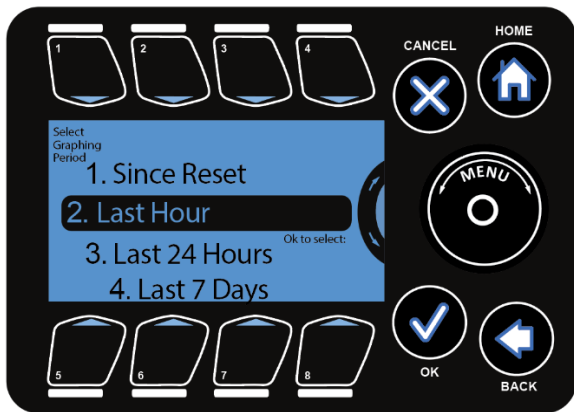

User can view the graphs for the following time periods

- Since Reset
- Last Hour
- Last 24 hour
- Last week
- Last 7 days

To highlight the sub options, **Wheel**, or **Buttons #1 - #5** can be used to go to the corresponding options. Pressing **OK** will let user can view the graphs.

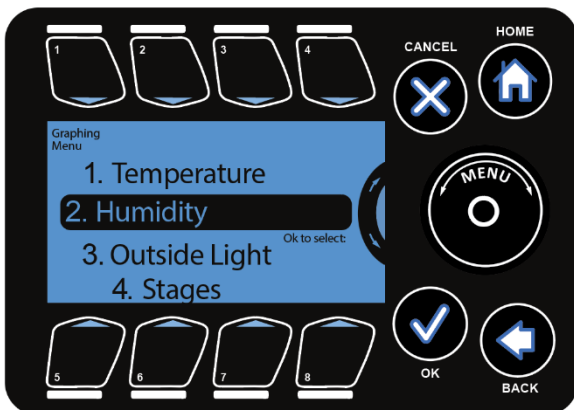

## Humidity

In the humidity option user can view graphs for the following

- Inside Humidity
- Outside Humidity
- Dehumidify Setpoint

To highlight the sub options **Wheel** or **Buttons #1 - #3** can be used to go to the corresponding options. Pressing **OK** will let user select the options. Like temperature option user can view graphs for different time periods.

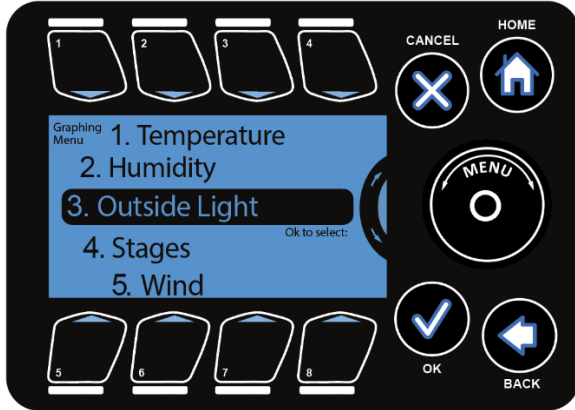

## Light

In the light option user can view graphs for the following time periods

- Since Reset
- Last Hour
- Last 24 hour
- Last week Last 7 days

To highlight the sub options **Wheel** or **Buttons #1 - #5** can be used to go to the corresponding options. Pressing **OK** will let user can view the graphs.

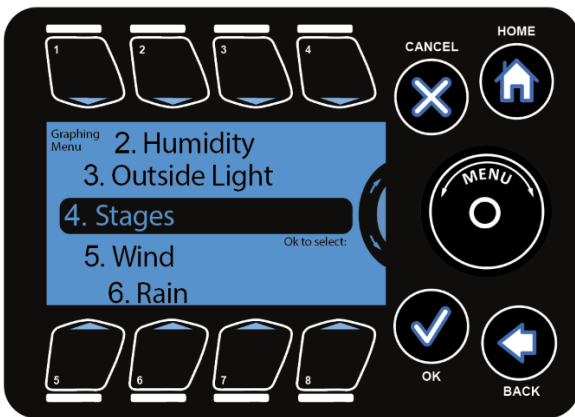

## Stages

In the stages option user can view graphs for the following

- Temperature Stage
- Humidity Stage

To highlight the sub options **Wheel** or **Buttons #1 and #2** can be used to go to the corresponding options. Pressing **OK** will let user select the options. Like temperature option user can view graphs for different time periods.

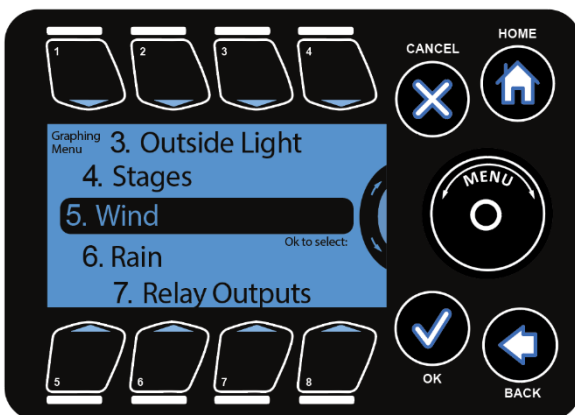

## Wind

In the wind option user can view graphs for the following

- Wind Speed
- Wind Direction

To highlight the sub options **Wheel** or **Buttons #1 and #2** can be used to go to the corresponding options. Pressing **OK** will let user select the options. Like temperature option user can view graphs for different time periods.

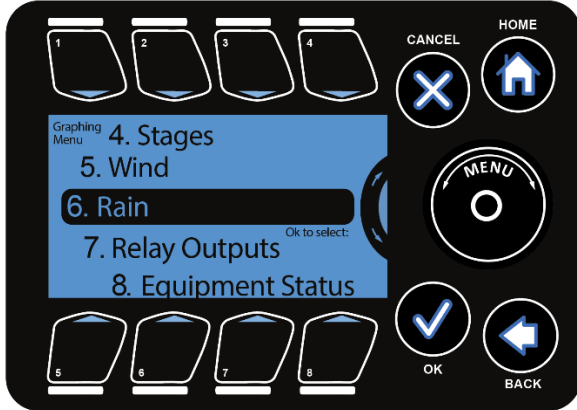

## Rain

In the rain option user can view graphs for the following time periods

- Since Reset
- Last Hour
- Last 24 hour
- Last week Last 7 days

To highlight the sub options **Wheel** or **Buttons #1 - #5** can be used to go to the corresponding options. Pressing **OK** will let user can view the graphs.

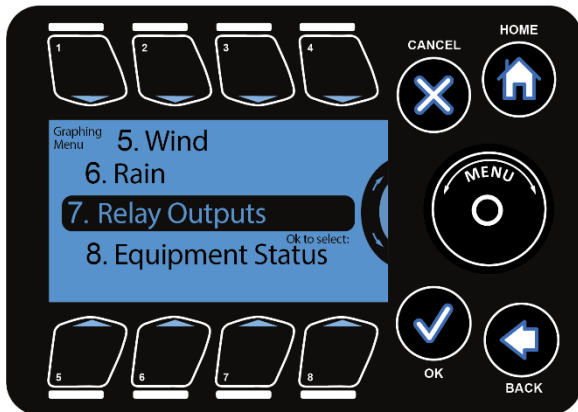

## Relay Outputs

In the relay option user can view graphs for Relay 1 output to Relay 8 output.

To highlight the sub options **Wheel** or **Buttons #1 - #8** can be used to go to the corresponding options. Pressing **OK** will let user select the options. Like temperature option user can view graphs for different time periods.

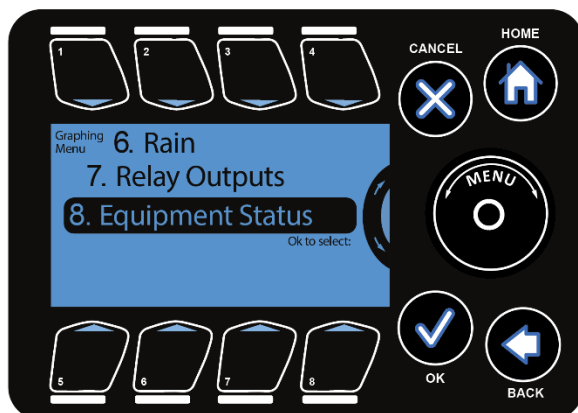

## Equipment Status

In the equipment status option user can view graphs for Channel 1 to Channel 8.

To highlight the sub options **Wheel** or **Buttons #1 - #8** can be used to go to the corresponding options. Pressing **OK** will let user select the options. Like temperature option user can view graphs for different time periods.

## Equipment Costs

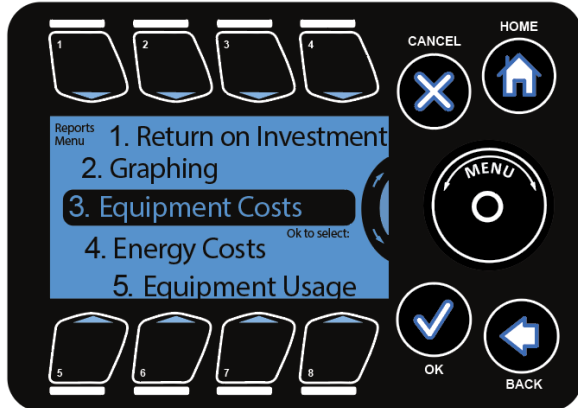

This section allows the user to review the operational cost of the climate zone broken down by equipment, expressed in percentages.

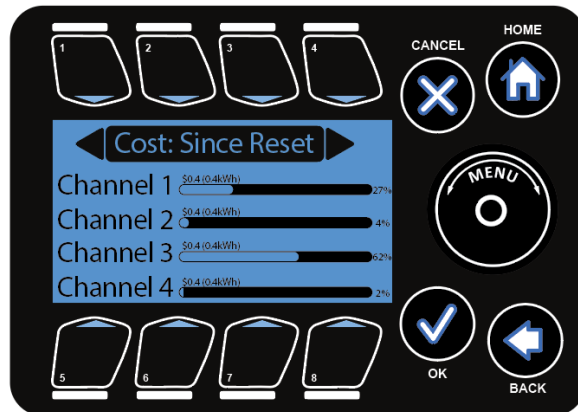

The equipment cost for the following time periods can be seen:

- Since Reset
- Last Hour
- Last 24 hour
- Last week
- Last 7 days
- Last 30 days
- This Month
- This year

To highlight the sub options **Wheel** or **Buttons #1 - #8** can be used to go to the corresponding options. Pressing **OK** will let user select the options.

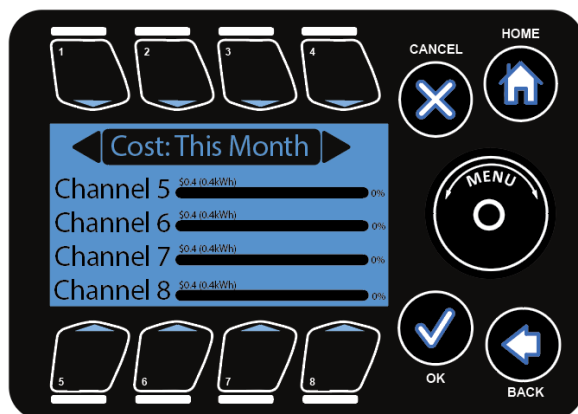

Use **Button #1 and #4** to change the time frame for the equipment costs.

Use the **Scroll Wheel** to view different equipment.

## Energy Costs

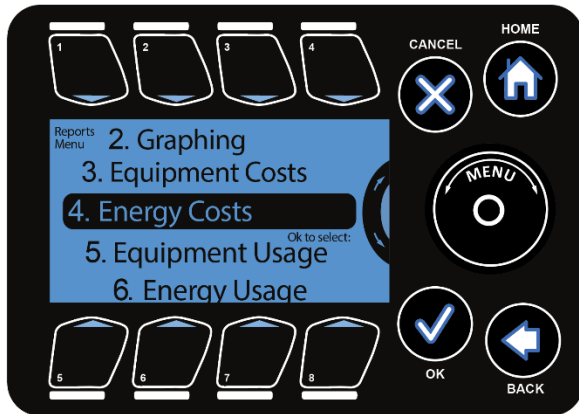

Here the user can review the operational cost of the climate zone broken down by energy types expressed as percentages.

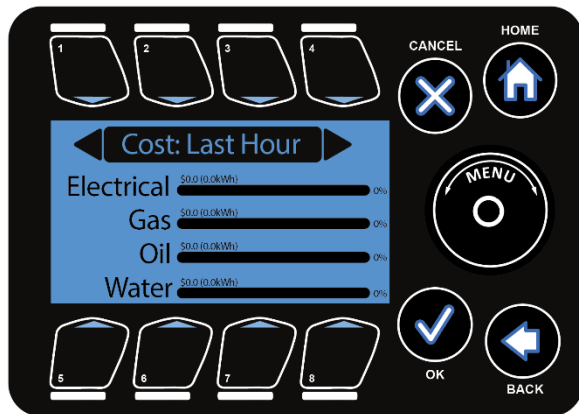

The energy cost for the following time periods can be seen:

- Since Reset
- Last Hour
- Last 24 hour
- Last week
- Last 7 days
- Last 30 days
- This Month
- This year

To highlight the sub options **Wheel** or **Buttons #1 - #8** can be used to go to the corresponding options. Pressing **OK** will let user select the options.

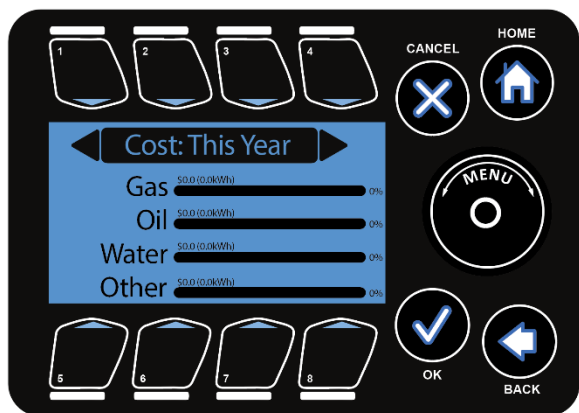

Use **Button #1 and #4** to change the time frame for the different energy types.

Use the **Scroll Wheel** to view different energy types namely electricity, gas, water, oil, and others.

## Equipment Usage

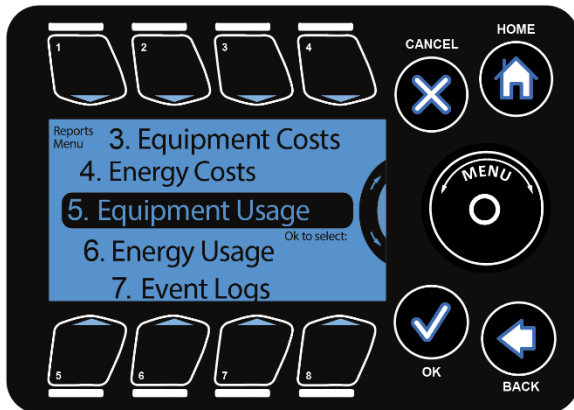

This is where the user can review the various equipment runtimes.

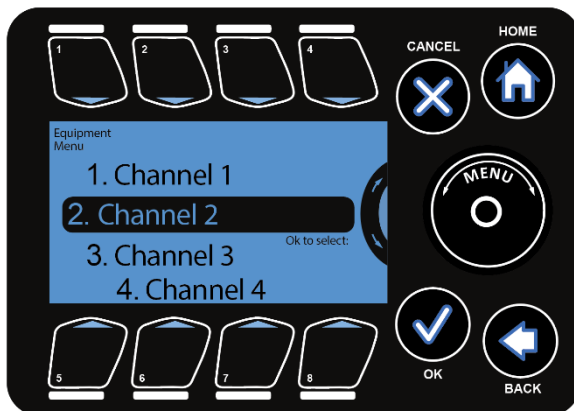

When selecting the equipment usage menu, the channels/equipment are listed.

*Note: that the names of the channels/equipment will change when you label the equipment in the subsequent menus.*

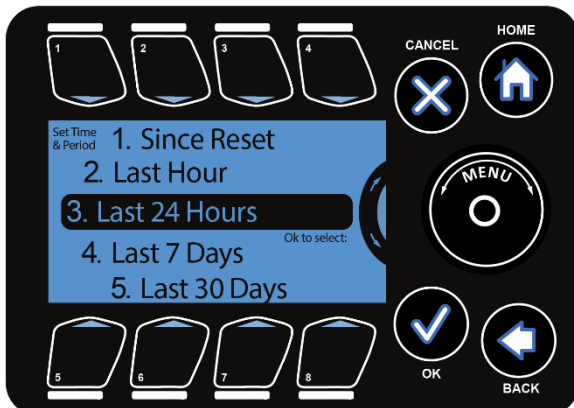

After selecting a given channel/equipment user can select a time to view the usage.

## Energy Usage

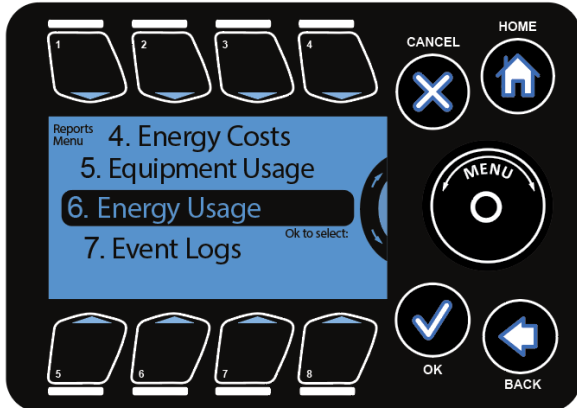

In this section the user can check the usage of individual energy types.

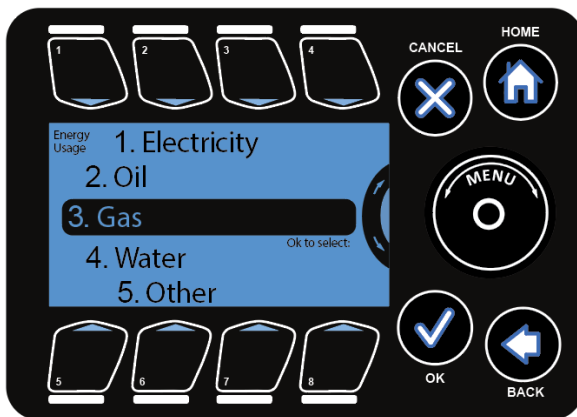

On selecting the energy usage screen, the different energy options are presented to choose from.

*Note: By default, all devices are of electrical energy type. The energy type for a device can be changed under the equipment setup.*

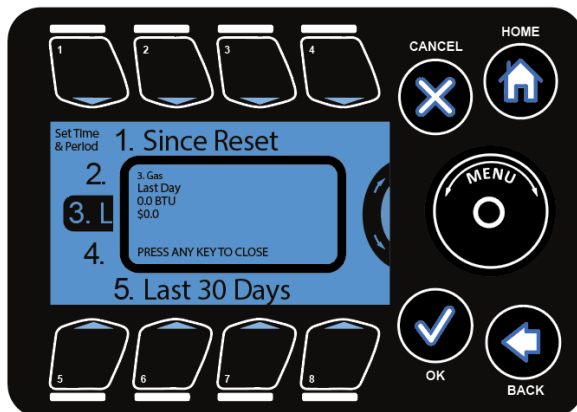

After selecting a given energy type user can select a time to view the usage.



## Event Logs

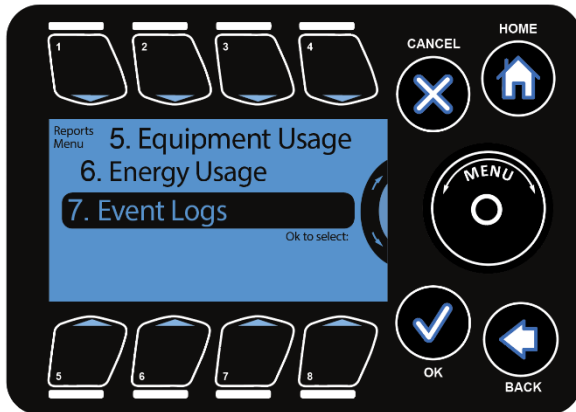

The event log options allow the user to view the history of various events which happened over a period like stage changes, sensor error, relay status changes, etc.

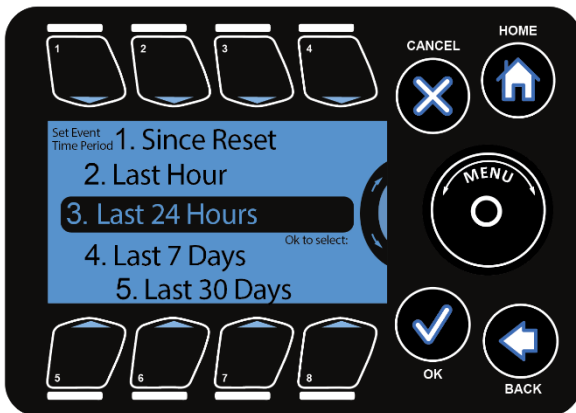

On selecting the event log the user is presented with the time periods to view the event logs over that duration.

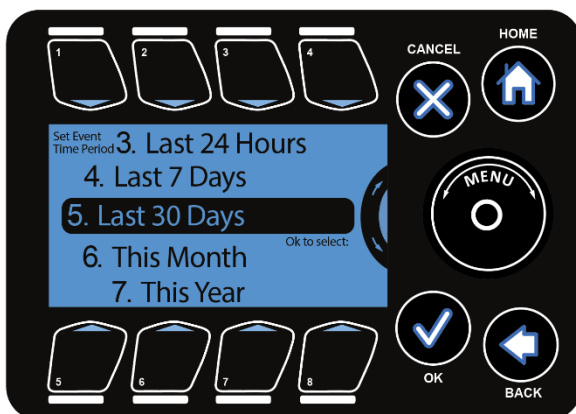

The following time periods are available

- Since Reset
- Last hour
- Last 24 Hours
- Last 7 days
- Last 30 days
- This month
- This year

To highlight the sub options **Wheel** or **Buttons #1 - #7** can be used to go to the corresponding options. Pressing **OK** will let user select the options

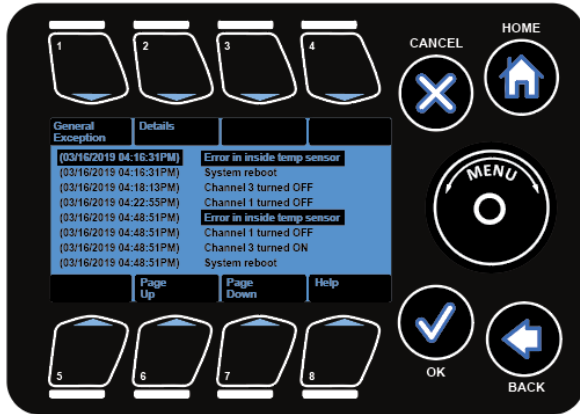

On selecting a time, the events from that time onwards are shown.

**Column 1:** Displays the timestamp at which the event occurred.

**Column 2:** Describes the event.

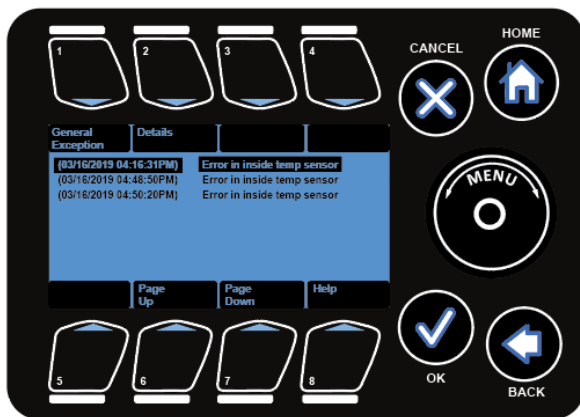

The screen allows the use to view either all the events or just the exceptions (**Button #1** toggles between **General/Exceptions**).

The default view is the general view, showing all the events, including the exceptions.

Note that the exceptions are highlighted in general view.

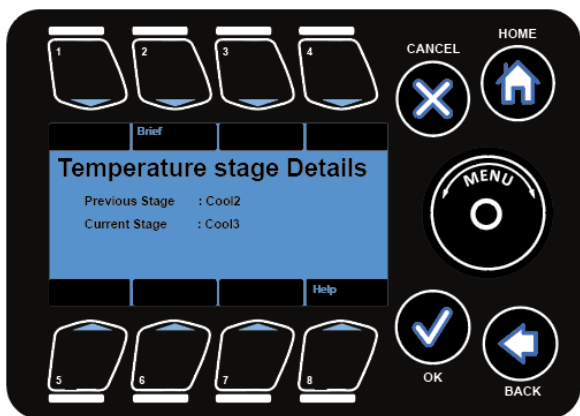

**Details:** elaborates the selected event.

**Page Up:** Allows the user to move up by a page

**Page Down:** Allows the user to scroll down by a page

*Note: that the wheel can be used to scroll through one event at a time.*

# System Setup

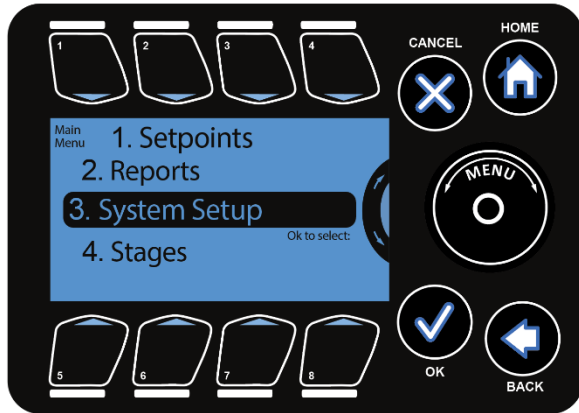

The **System Setup** is the third option in the main menu where the user can setup the equipment at installation time, as well as other miscellaneous operations.

Pressing **OK** or **Button #3** will let the user to go to system setup submenu.

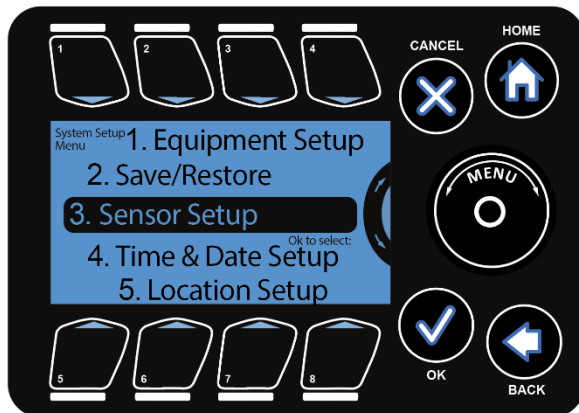

The subsections under the system setup are:

1. Equipment Setup
2. Save/Restore
3. Sensor Setup
4. Time & Date Setup
5. Location Setup
6. Energy Cost
7. IP Address Setup
8. Measurement Units
9. Advanced

To highlight the sub options **Wheel** or **Buttons #1**

- **#8** can be used to go to the corresponding options. Pressing **OK** will let user select the options.

*Note: that each of these subsections is described in detail in the following pages.*

## Equipment Setup

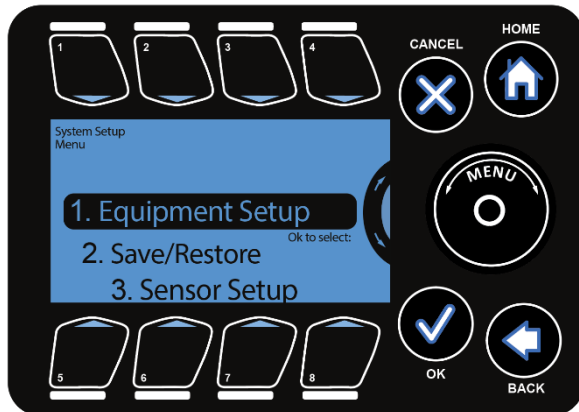

This section allows user to setup the equipment on the various channels, set their type, assign names, energy type, etc.

*Note: Equipment is programmed individually.*

*Note: All subsequent screens are applicable to the selected equipment only.*

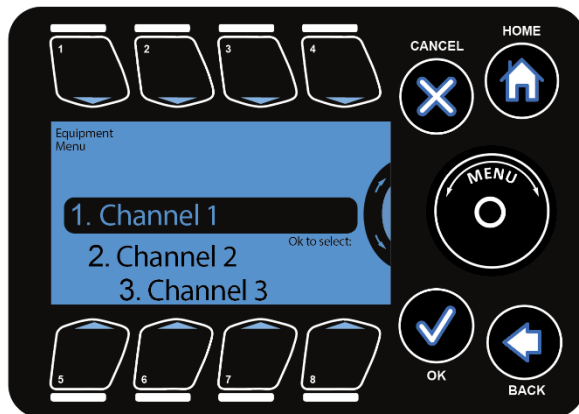

On selecting the equipment setup, the various **Channels** in which the equipment is connected can be selected.

*Note: that these channels correspond to the physical outputs on the unit.*

*Note: Vents and curtains require two adjacent channels starting with an odd numbered channel.*

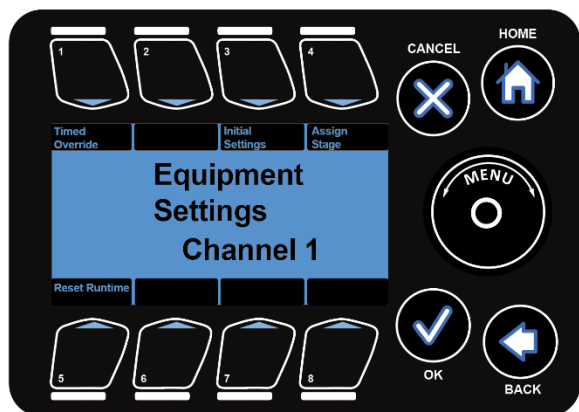

Selecting a channel gets you to the equipment screen. Here you can:

Set a timed **Override**

Run an **Initial Setup** (set the equipment name, its type, the energy type, etc.)

**Assign Stages** to each of the equipment channels.

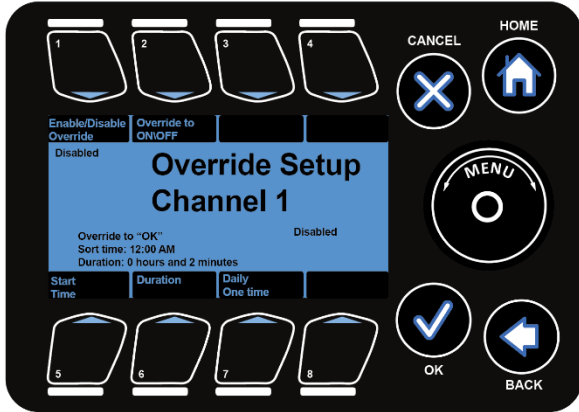

Timed override will switch ON or OFF the corresponding equipment during the specified time set by user.

The timed override is provided for the user to set either a daily recurring event or a onetime event. This can be done by pressing **Button #7**.

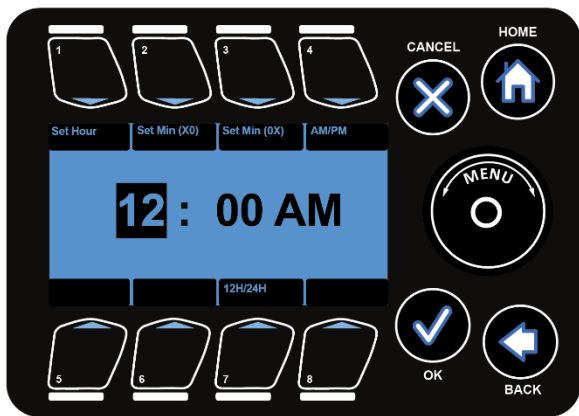

The start time for the override can be set using this screen.

Start time can be changed by pressing **Button #5**.

**Buttons #1 - #4** are used to highlight time options.

**Wheel** can be used to increase or decrease the highlighted value.

*Note: that you can toggle between either a 12- or 24-hour clock using button #7.*

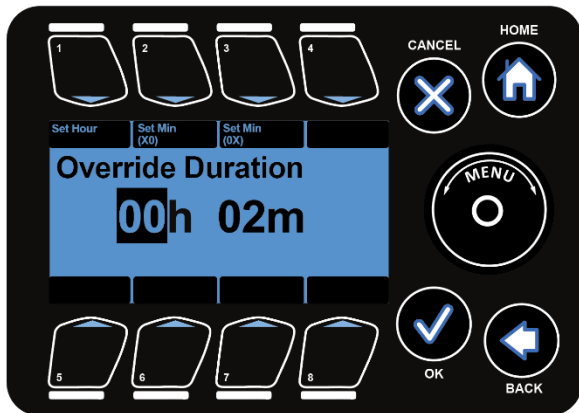

The override duration can be set using this screen as shown.

**Button #1 - #3** can be used to highlight a given field and the wheel can be used to modify (increment/decrement the highlighted field).

**Back** can be used to go to the equipment settings

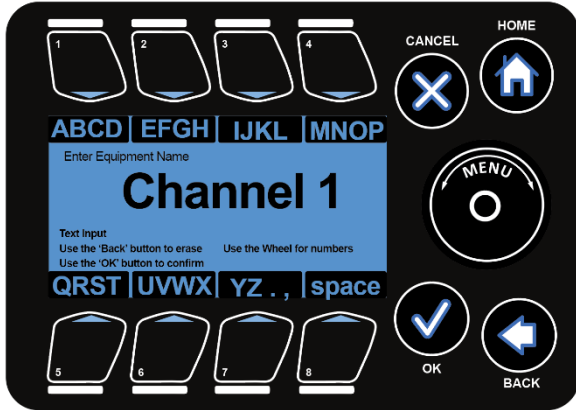

Before equipment can be utilized, the proper equipment type must be defined.

User can go to Initial setting (press **Button #3**) to set the name and type of the corresponding channel.

An optional, but useful, step is to assign a name to the equipment. This name will be displayed at the MAIN status screen. **Button #3** can be used to go set name option.

The figure below shows the screen to set up the name of the equipment.

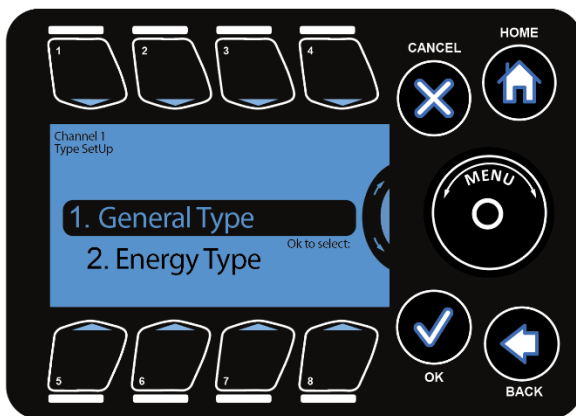

Back button is be used to delete the present name i.e., Channel 1. Then, user can enter the desired name.

This screen is like the mobile phone SMS screen. To select a given alphabet press the required button the number of times = the position of the alphabet in the button. E.g. to type C press **Button #1** three times. To enter numbers, use the **wheel**.

*Note: If the equipment is a dual channel (vent/curtain) device, the name of the second channel (the even channel) is the same as the first (odd) channel.*

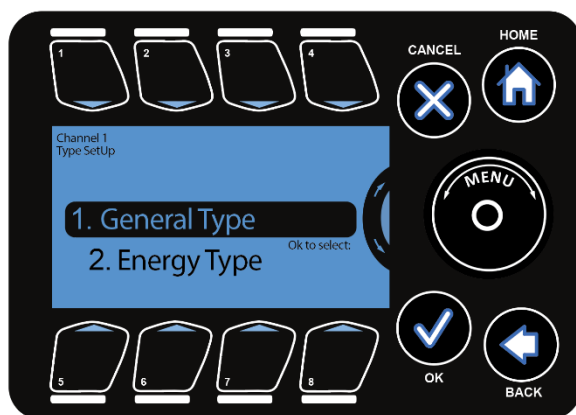

**Button #1** can be used to go set type option. There are two types for each piece of equipment:

**General Type:** The kind of equipment this output controls. There are 4 available equipment types (see below).

**Energy Type:** The type of energy this equipment consumes (see 2 screens below).

Under the general/energy type setup the type which is selected is the one surrounded by parenthesis. The image in the following figure shows that On/Off device is selected.

## General Type

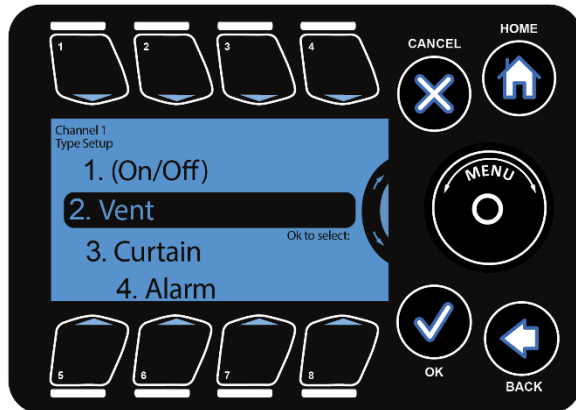

The general equipment types are:

**ON/OFF:** Refers to any piece of equipment that turns on and off in each of the heating/cooling/dehum stages. For example, heater, fan, cool pad, pump, etc.

**VENT:** Refers to a proportionally controlled ventilation equipment, e.g. side wall, ridge vent.

**CURTAIN:** Refers to a shading system.

**ALARM:** Use the alarm output to turn an output on depending upon crossing a temperature level.

This is normally connected to a telephone dialer such as the Sensaphone.

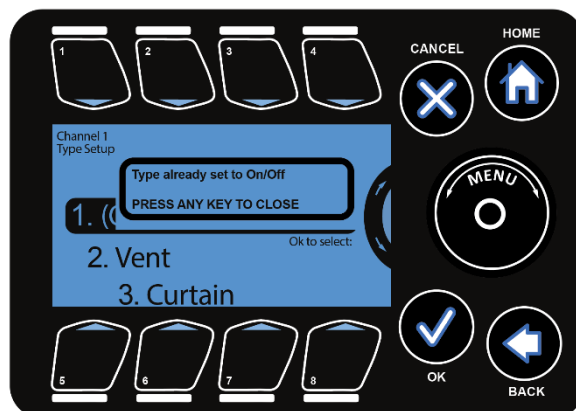

To highlight the sub options use Wheel or **Buttons #1 - #4** corresponding to the options and **OK** to select the options

By default, all equipment is marked as On/Off device.

If a type that has already been chosen (i.e. surrounded by parenthesis) is selected again, we get this prompt.

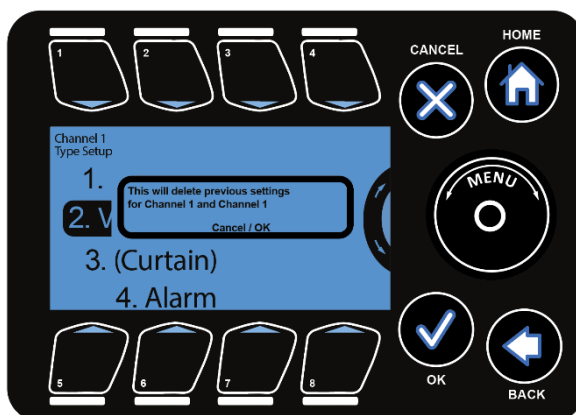

To change the type to some other type like, from On/Off to Vent as shown in the figure, we get a warning popup as shown in figure.

Vents requires 2 consecutive output channels (1 & 2, 3 & 4, 5 & 6, 7 & 8). The first channel (odd numbered) must be wired to Open vent, and the other (even numbered) to CLOSE it.

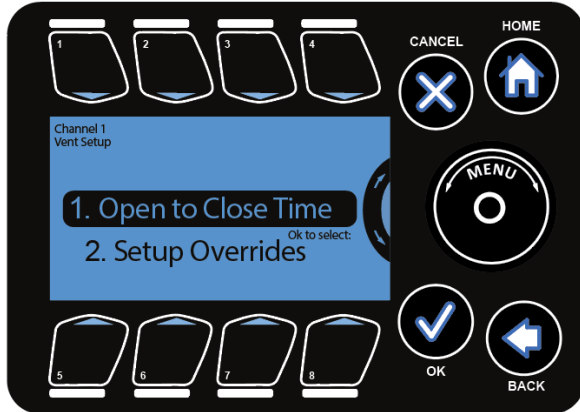

On selecting a vent, the user needs to do the setup of the following:

- Open to Close time
- Overrides

To highlight the sub options use **wheel** or **Buttons #1 and #2** and **OK** to select the options.

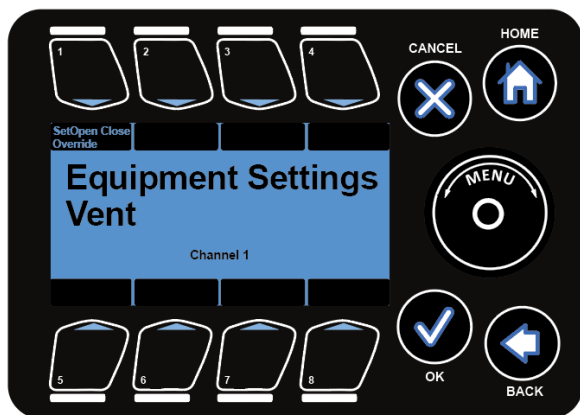

The Vent Open-Close Time is the time in minutes and seconds that it takes for the vent to go from full closed to fully open position and vice versa.

On selecting the Set Open-Close Duration the following screen comes up.

By pressing **Button #1** user can go Set Open/Close time duration option.

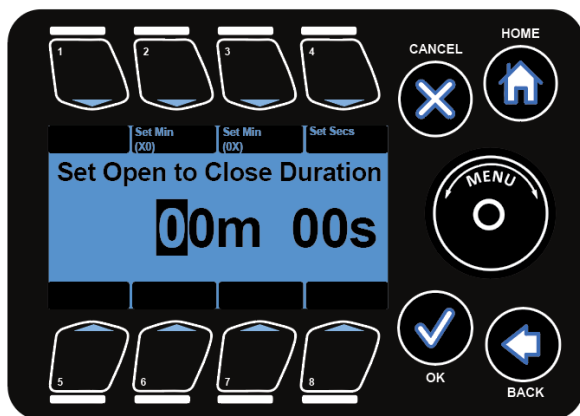

The screen enables to set the Open-Close Duration.

**Buttons (#2, #3, #4)** are used to highlight the fields and the **Wheel** is used to increment and decrement the field values.

*Note: To determine the vent open-close time turn the manual toggle switch on and use a clock or stopwatch to time the vent as it goes from its fully closed to open position.*



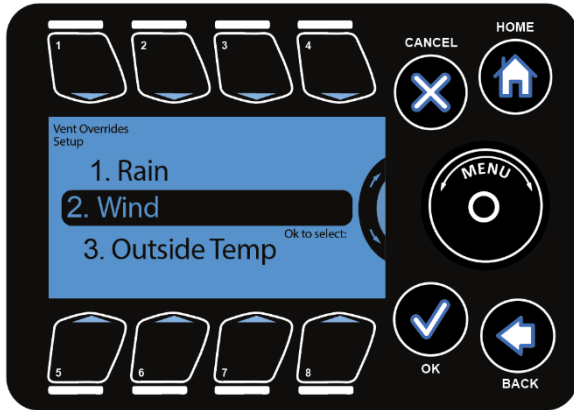

Navigating back to the Setup Overrides menu, you get this screen.

These overrides are important for safe and effective vent operations.

To highlight the sub options **Wheel** or **Buttons #1 - #3** can be used. Options can be selected by pressing **OK**.

*Note: The weather station or some of its core components need to be installed to setup these overrides.*

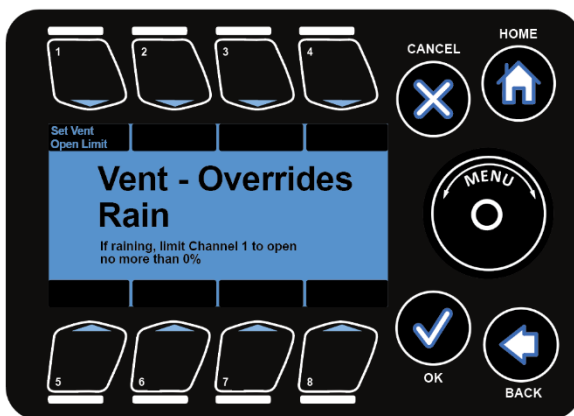

**Rain Vent Open Limit:** This is the maximum position the vent can be open when the rain is detected.

The value can be changed by selecting Button #1 and the Wheel can be used to modify the value

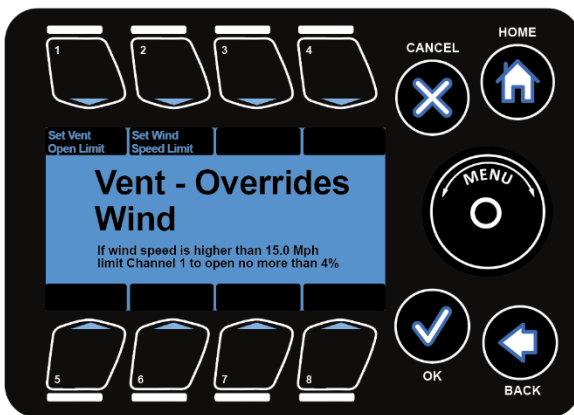

### Wind Vent Override

**Set Vent Open Limit:** This is the maximum position the vent can be open when the wind is at or exceeding a user-specified speed.

**Set Wind Speed Limit:** This is the user-specified wind speed value which triggers the Vent Open Limit.

These values can be changed by selecting **Buttons #1 and #2**. **Wheel** can be used to modify the value.

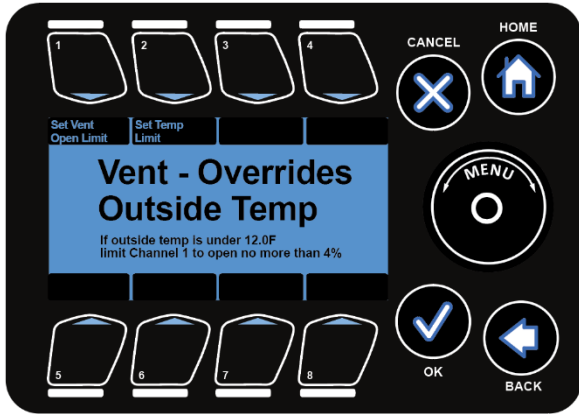

## Outside Temp Vent Override

**Set Vent Open Limit:** This is the maximum position the vent can be open when the outside temperature is below the set temperature limit.

**Set Temp Limit:** This is the user specified temperature value which triggers the Vent Open Limit when temperature drops below set value.

These values can be changed by selecting **Buttons #1 and #2**. **Wheel** can be used to modify the value

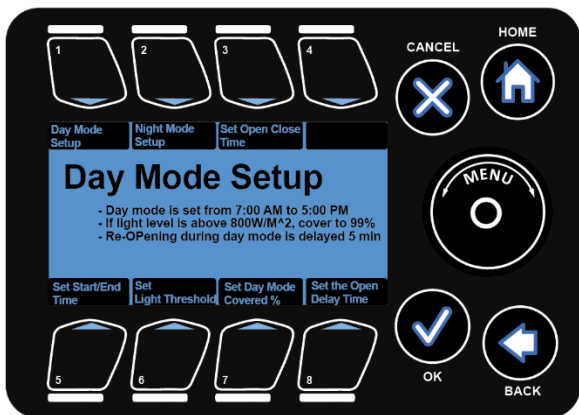

The curtains are also a dual channel device and can only be programmed starting on an odd channel.

The curtain can be programmed for the **Day** and **Night** mode. By pressing **Buttons #1 and #2** user can go to these options.

The duration for the start of each mode can be set using **Set Start/End Time**. User can select this option by pressing **Button #5** and then **OK**.

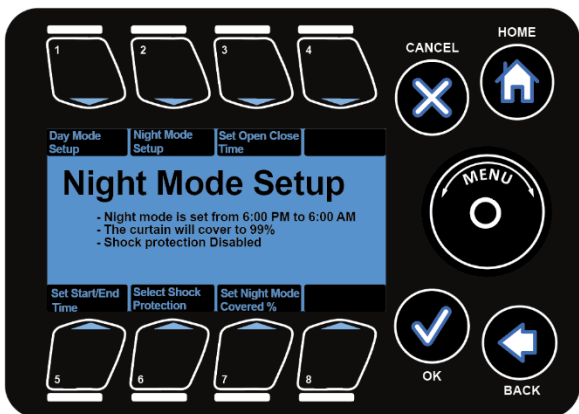

**Open Close Time:** It is the time taken for the curtain to go from full covered to full uncovered mode and vice versa. By pressing **Button #3** user can go to this option.

**Light Threshold:** In case a light sensor is present, the light threshold value at which the curtain should shade/cover. By pressing **Button #6** user can go to this option.

**Reopen Delay Time:** The time delay after which the curtain can again be opened. By pressing **Button #8** user can go to this option. **Wheel** can be used to increase or decrease the values

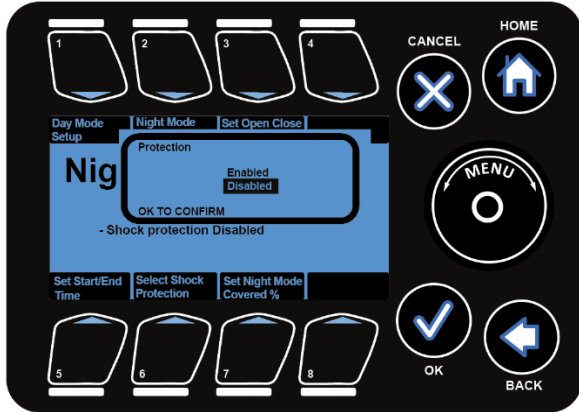

**Shock Protection:** Selecting a shock protection mode helps in opening the curtain slowly, preventing it to open all at once and thus preventing sudden temperature changes.

Press **Button #2** to go to night mode setup option. Then, press **Button #6** to go to this option

*Note: Covered % is the amount by which the curtain should be covered.*

By pressing **Button #7** user can go to % covered option. **Wheel** can be used to increase or decrease the value



The day mode and the night mode start time can be set to an absolute value using the screen as shown or to the sunrise and sunset values.

Location setup can be used to input the coordinates

Press **Button #5** and **OK** to confirm.

Then user can change the time by pressing **Buttons #1, #2, #3, #5, #6**.

*Note: The sunrise and sunset values will correctly be calculated only if the location coordinates are entered correctly.*

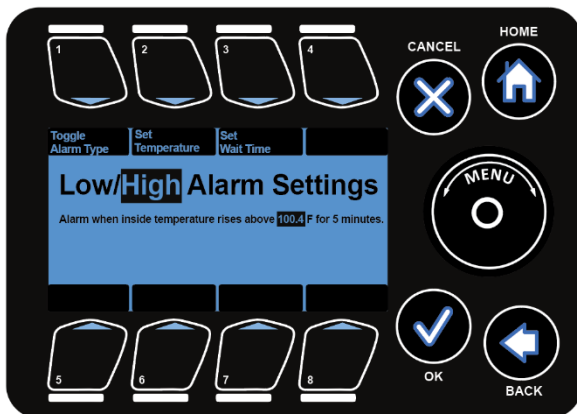

Any one of the available 8 channels can be selected to be an alarm output.

**Set Temperature:** This Tab lets you select the temperature threshold above or below which the alarm will be triggered.

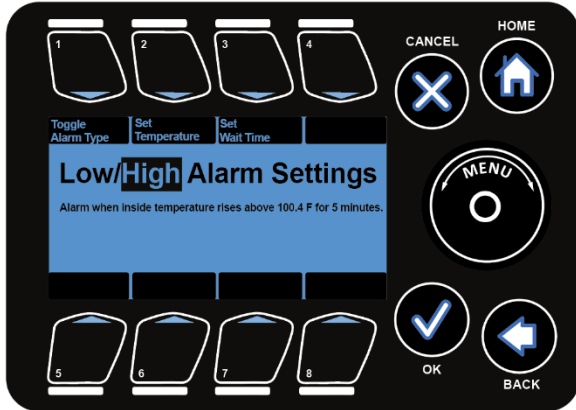

**Toggle Alarm Type:** There are two temperature alarm settings that can be programmed. One is a High temp alarm; the other is a Low Temp alarm.

Pressing **Button #1** enables you to toggle the programming screens between the two options.

After selecting low/high options, **Button #2** will allow user to set temperature. **Wheel** is used to increase or decrease the values.

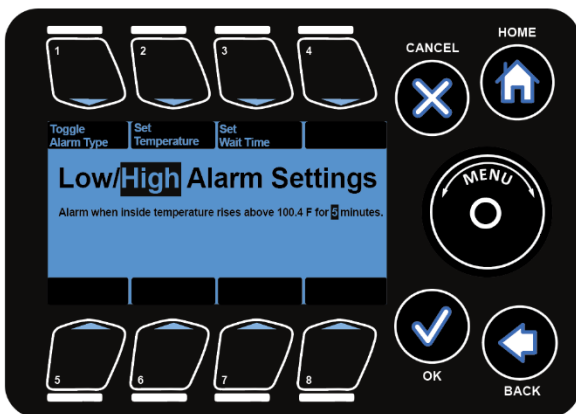

**Wait Time:** This Tab lets to set a wait time before the alarm is triggered. This time can be set from 0 to 99 minutes.

*Note: If the temperature drops below the threshold during the wait time, the clock will be reset to 0.*

By pressing **Button #3** user can go to this option

**Wheel** is used to increase or decrease the values.

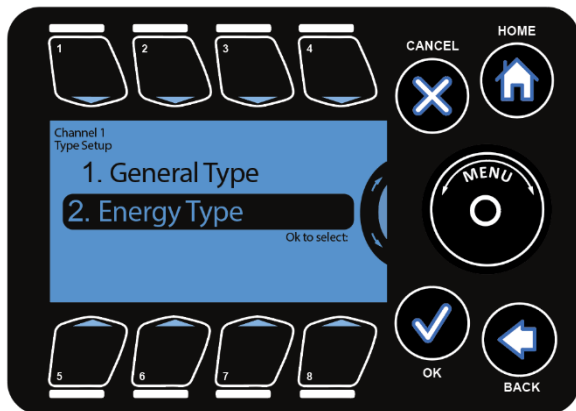

The 100 Series controllers have the capability to calculate energy consumption. To accomplish this, the type of energy consumed by the equipment must be identified.

There are the 5 energy types currently supported.

## Energy Type

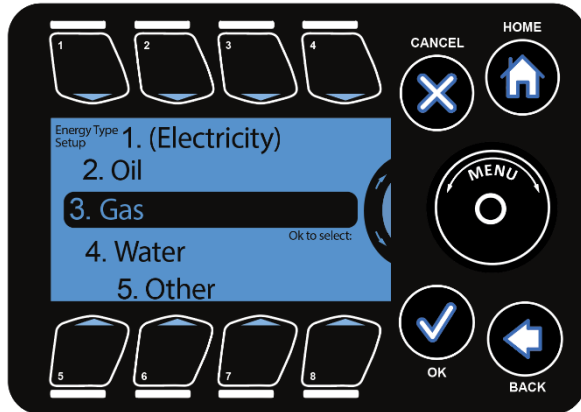

Once the energy type is selected, the user will be prompted to enter the relevant information in order for the controller to accurately determine the energy consumption rate.

It is advised to use accurate instruments (by trained personnel) to measure the consumption rate of the equipment, since this determines the accuracy of the controller's ability to determine cost.

User can check the status by pressing **Button #7** for any energy type

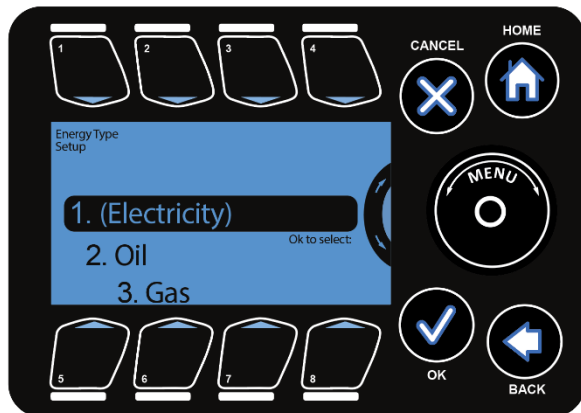

The energy type selected is indicated by parenthesis across the type as shown for Electricity in the figure.

For choosing a different type move the highlight to the required type and press **OK**.

By default, all energy types are set to electricity.

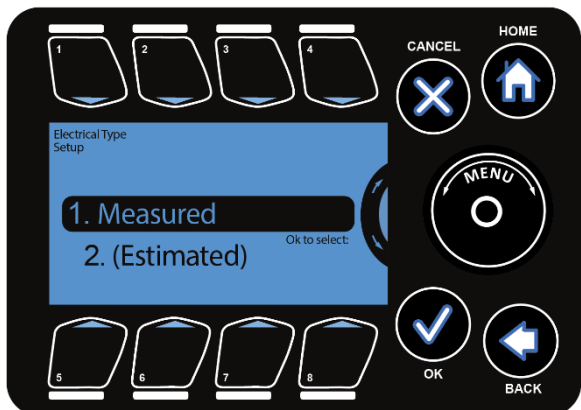

The electrical energy type setup can be done to an actual measured value or a rough estimated value.

The type of setup selected is indicated by the parenthesis around the type.

The estimated electrical setup is set by default.

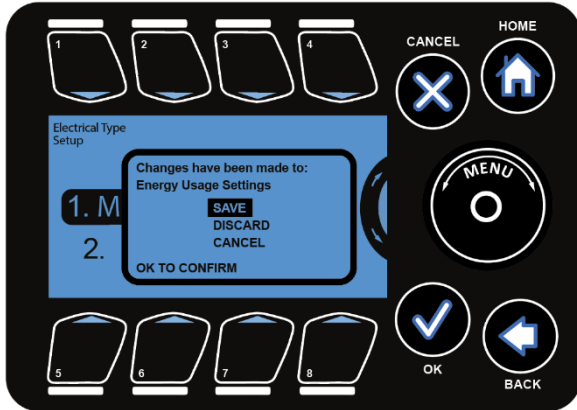

To enable a precise measured calculation of the electrical consumption, select **Measured** and press **OK**.

*Note: A confirmation popup comes up indicating the change in setup as shown.*

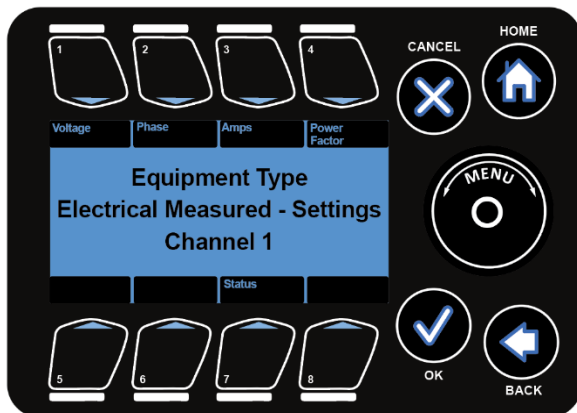

The Voltage Phase, amperes (Amps) and the Power Factor (PF) values are entered by pressing **Buttons #1 - #4** and using the **Wheel** to modify the values.

Using the above values, the kW value is calculated.

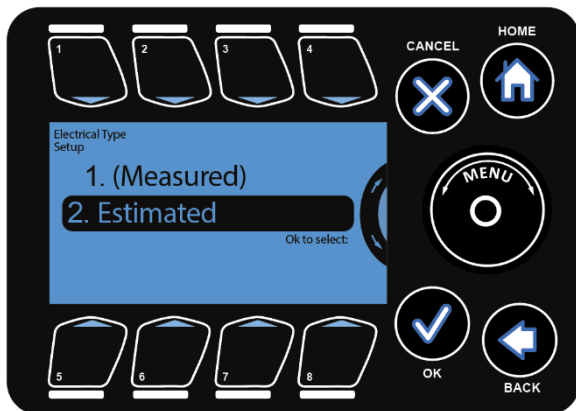

To enable a rough/approximate calculation of the electrical consumption, the estimated setup is selected.

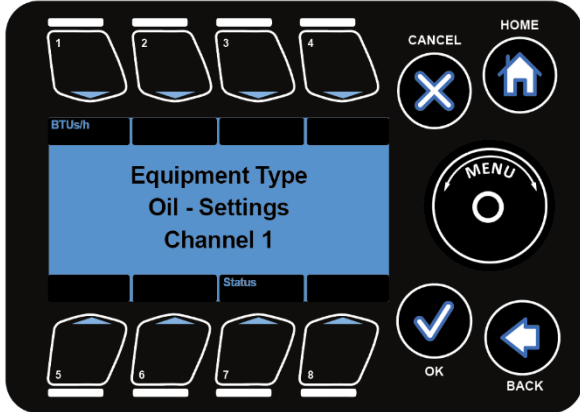

The Voltage, HP/kW/Amps, Motor efficiency and operational load values are entered by pressing **Button (#1, #2, #3, #4)** and using the **Wheel** to modify the values.

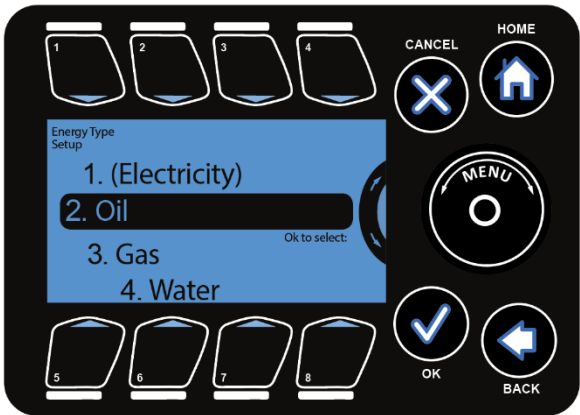

### Energy Type - Oil

For setting the energy type as Oil the highlight is moved to the Oil type by pressing **Button #2** or by using the wheel and pressing **OK**.

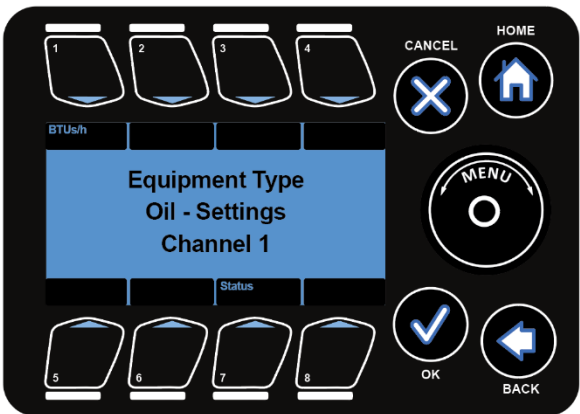

The unit of measurement is BTUs/hr.

The value of BTU/hr is entered by pressing the **Button #1** and modifying the values by using the wheel.

The default value is 1 BTU/hr.

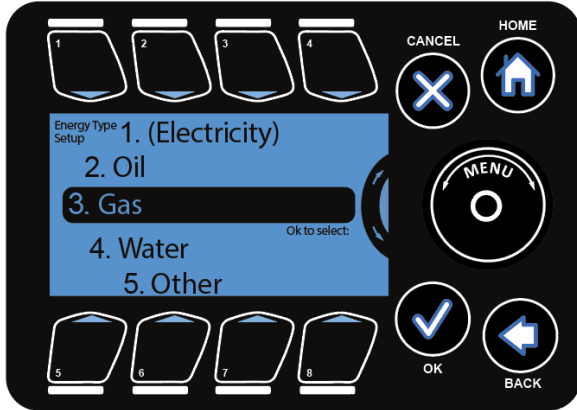

### Energy Type - Gas

For setting the energy type as Gas, the highlight is moved to the gas type by pressing **Button #3** or by using the **Wheel** and pressing **OK**.

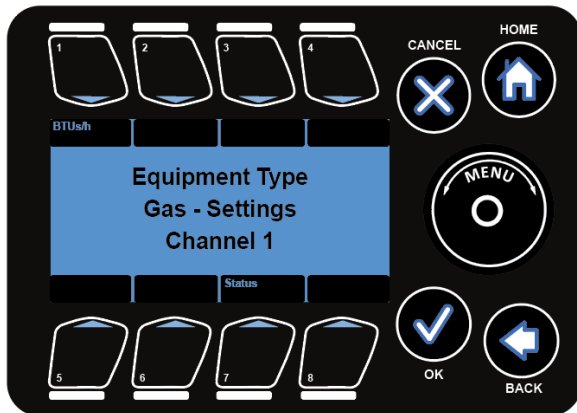

The unit of measurement is BTUs/hr.

The value of BTU/hr is entered by pressing the **Button #1** and modifying the values by using the **Wheel**.

The default value is 1 BTU/hr.

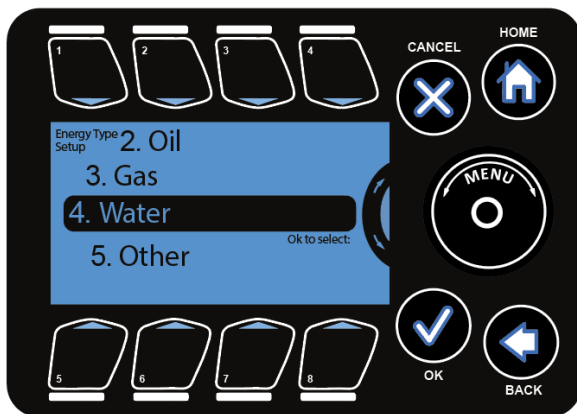

### Energy Type - Water

For setting the energy type as Water, the highlight is moved to Water type by pressing **Button #4** or by using the **Wheel** and pressing **OK**.



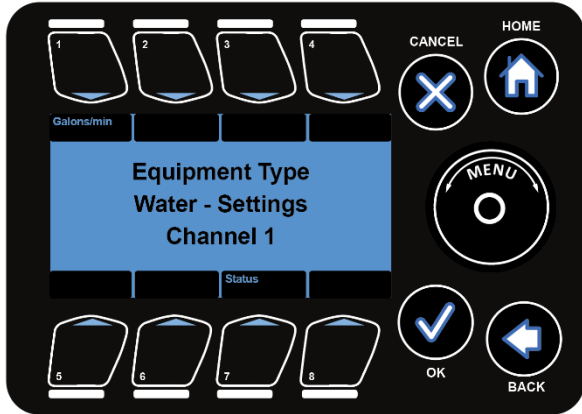

The unit of measurement is gallons per minute.

The value of Gallon/min is entered by pressing the **Button #1** and modifying the values by using the **Wheel**.

The default value is 1 Gallon/min.

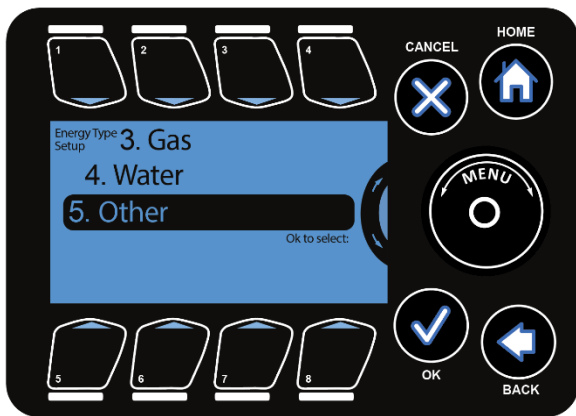

**Energy Type - Other**

For setting the energy type as Other, the highlight is moved to the Other type by pressing **Button #5** or by using the **Wheel** and pressing **OK**.

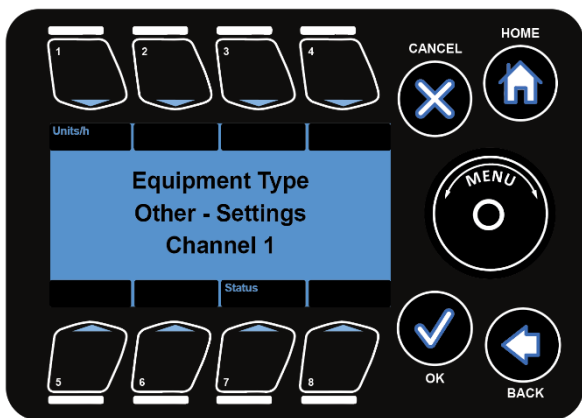

The unit of measurement is units per hour.

The value of Units/hr is entered by pressing the **Button #1** and modifying the values by using the **Wheel**.

The default value is 1 Unit/min.

## Assign Stages

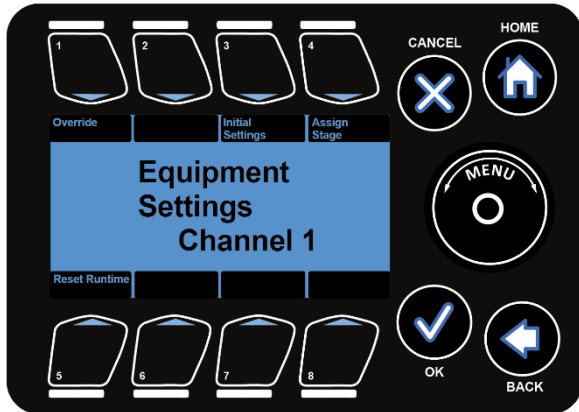

Assigning of stages can be done for a given channel through **Assign Stage** button at the Equipment Settings menu or directly through the Staging line on the main menu.

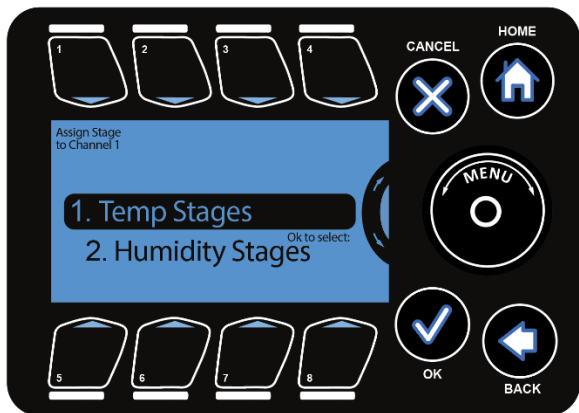

The Stage settings can set for:

- Temp Stages
- Humidity stages

*Note: There are 8 temperature stages and 4 humidity stages.*

There are 2 heating (H1, H2) and 6 cooling (C1, C2, C3, C4, C5, C6) stages.

The normal stage (N) is when neither heating nor cooling is required. C1 is the lowest stage of cooling and C6 the highest while H1 is the lowest heating stage and H2 is the highest.

# Temperature Stages

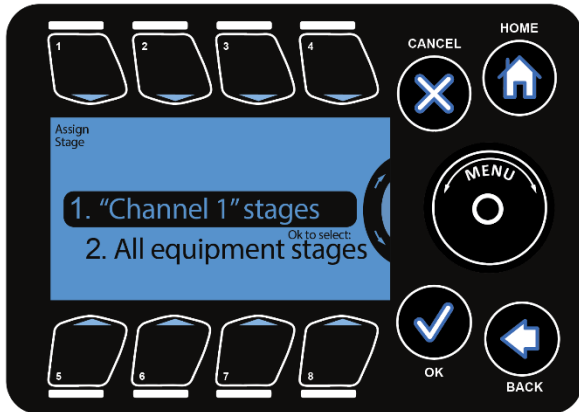

**"Channel" stages:** This selection allows the user to set staging parameters on the current channel they are under.

**"All Equipment" stages:** This selection provides a table with each piece of equipment in the left column and each stage of heating and cooling across the top. It gives a quick over- view of how all the equipment fit on the staging table.

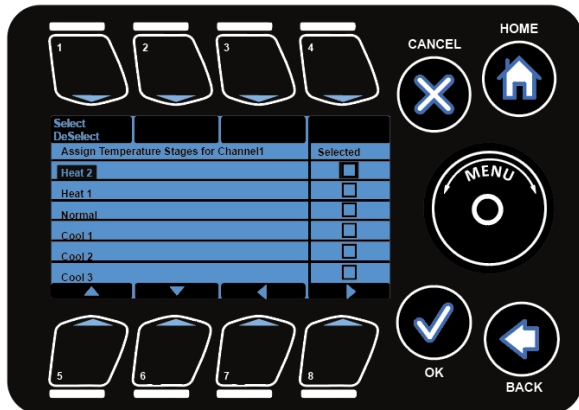

When choosing to assign individual equipment to a temperature stage the following screen is shown.

The **Select/DeSelect** button or the **OK** button can be used to check/un- check the selection for the current stage.

The temperature stages are not applicable.

### For On/Off Devices:

**Unchecked Boxes:** Means device is off for that stage.

**Checked Boxes:** Means device is on for that stage.

### For Vents:

**0%:** indicates that vent is closed for that stage.

**99%:** indicates the vent is fully open for that stage.

**Intermediate % value:** Indicates the percentage of vent open for that stage.

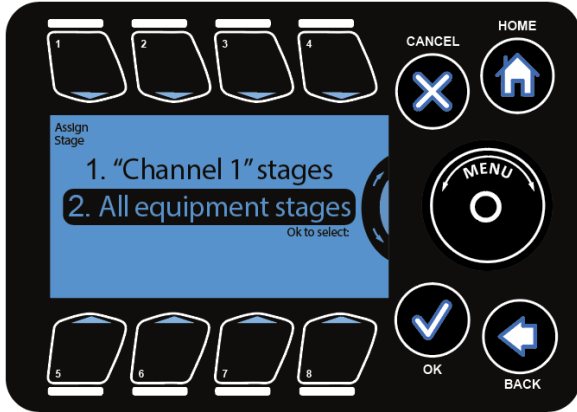

The user can quickly set the temperature staging options for every piece of equipment by selecting the "All equipment" stages option on the Assign Stage menu.

Enter this menu by highlighting it using the **Wheel** or **Button #2** and pressing **OK**.

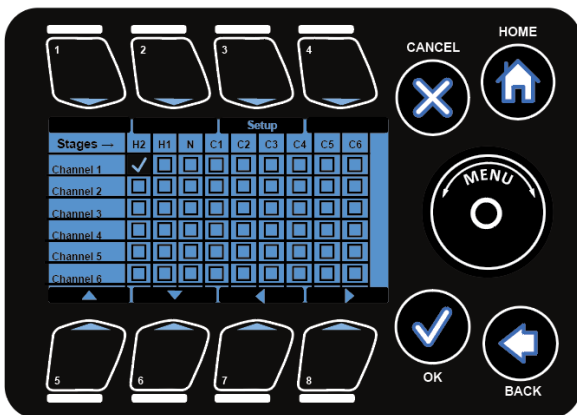

The **arrows** are used for moving the highlight to the desired stage. The **Setup** and **OK** buttons are used to select or deselect the highlighted stage for a device.

For On/Off device types all stages are active i.e. they can select or deselect. For Vents, the heating stages H2 and H1 are not applicable and the desired percentage of the vent position is set using the wheel.

#### For Curtains:

The temperature stages are not applicable.

#### For On/Off Devices:

**Unchecked Boxes:** Means device is off for that stage

**Checked Boxes:** Means device is on for that stage.

#### For Vents:

**0%:** indicates that vent is closed for that stage.

**99%:** indicates the vent is fully open for that stage.

**Intermediate % value:** Indicates the percentage of vent open for that stage.

*Note: For dual channel devices (vents/curtains) the second channel is disabled.*

## Humidity Stages

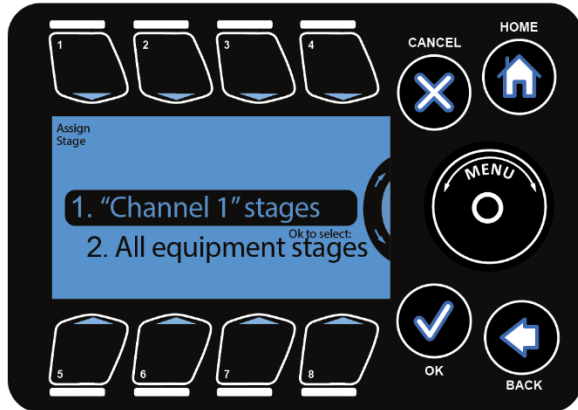

**"Channel" stages:** This selection allows the user to set staging parameters on the current channel they are under.

**"All Equipment" stages:** This selection provides a table with each piece of equipment in the left column and each stage of heating and cooling across the top. It gives a quick overview of how all the equipment fit on the staging table.

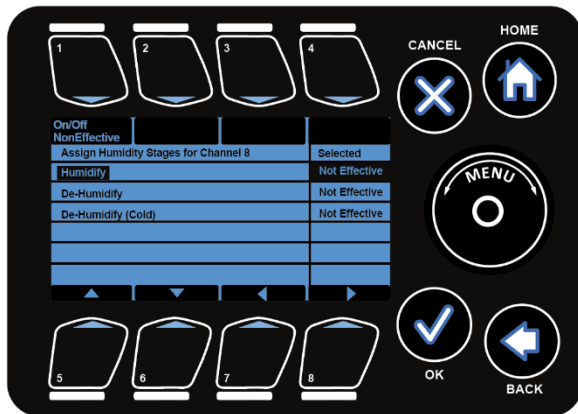

When choosing to assign individual equipment to a humidity stage the following screen is shown.

The **arrows** are used for moving the highlight and the **On/Off/Non-Effective** button is used to select or deselect a given stage for a device.

*Note: If the channel is mapped to a Vent or a Curtain, Button #1 changes contextually.*

**Humidify:** Is engaged when the humidity value is below the Humidify (Low humidity) setpoint value.

**Dehumidify:** Is engaged when the humidity value goes above the Dehumidify (High Humidity) setpoint value.

**Cold De-humidify:** Is engaged when the outside temperature goes below the threshold value set in advanced screen.

*Note: Curtains and Vents are adjusted incrementally (%) using the scroll wheel.*

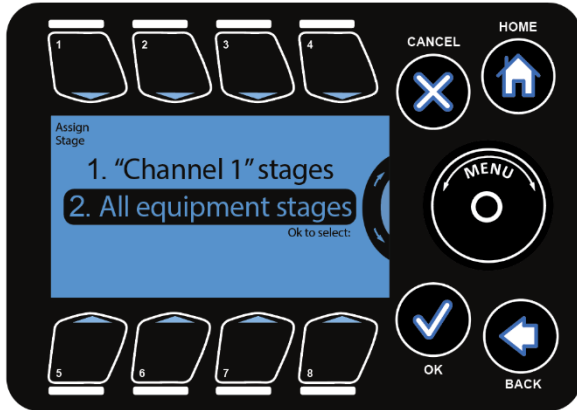

The user can quickly set the humidity staging options for every piece of equipment by selecting the "All equipment" stages option on the Assign Stage menu.

Enter this menu by highlighting it using the **Wheel** or **Button #2** and pressing **OK**.

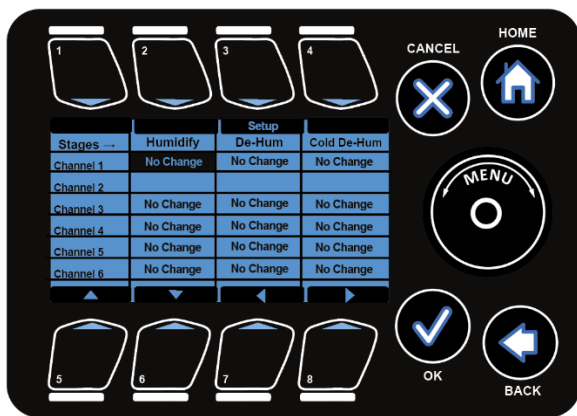

The **arrows** are used for moving the highlight to the desired stage. The **Setup** and **OK** buttons are used to select or deselect the highlighted stage for a device.

For dual channel devices (vents/curtains), the second channel is disabled as shown.

#### For Curtains:

**0%:** Curtain is 0% covered

**99%:** Curtains is 99% covered

**Intermediate %:** Percentage of curtain covered.

**No Change:** Devices are not affected in that stage.

#### For On Off Devices:

**Override Off:** Indicates device is Off in that stage.

**Override On:** Indicates device is on in that stage.

**No Change:** Device does not have an effect in that stage.

#### For Vents:

**0%:** Indicates vent is fully closed.

**99%:** Vent is fully open.

**Intermediate %:** % of vent open

**No Change:** Devices are not affected in that stage.

## Reset Runtime

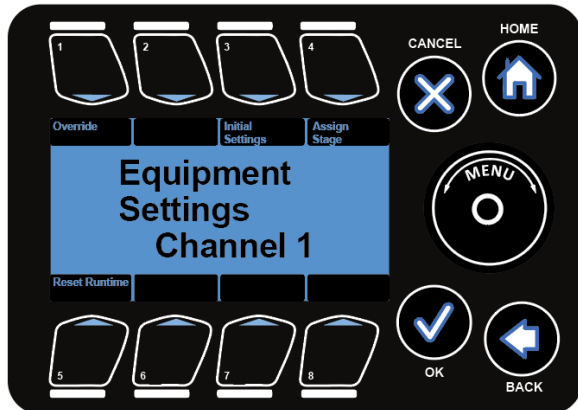

The runtime counter for an equipment channel can be reset in the main Equipment Settings menu.

This is useful when a user changes any equipment previously mapped to a channel.

While in the main Equipment Settings menu, press **Reset Runtime**.

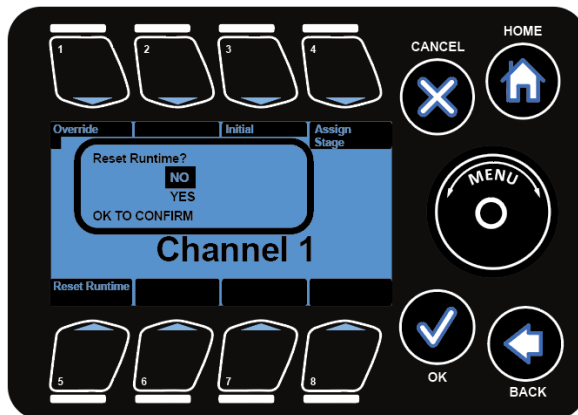

The runtime values are used in ROI calculations and runtime accuracy is important for accurate cost calculations.

User will be prompted with yes or no option. User can select any option by using **Wheel** and pressing **OK**.

*Note: The runtime is set to 0 if yes is selected.*

*Note: This cannot be undone.*

## Save and Restore

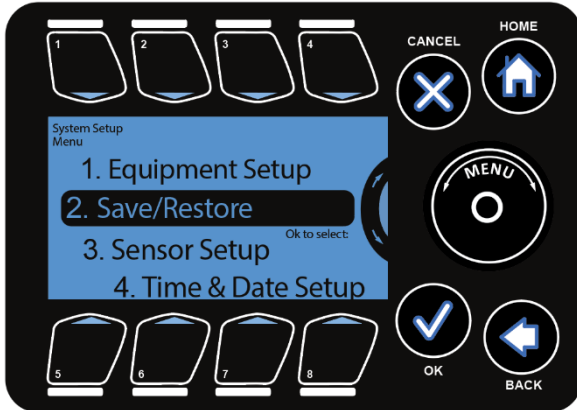

The controller's settings as well as the log files can be saved either to onboard memory or a USB memory stick.

Data can also be recalled from the files stored to the controller.

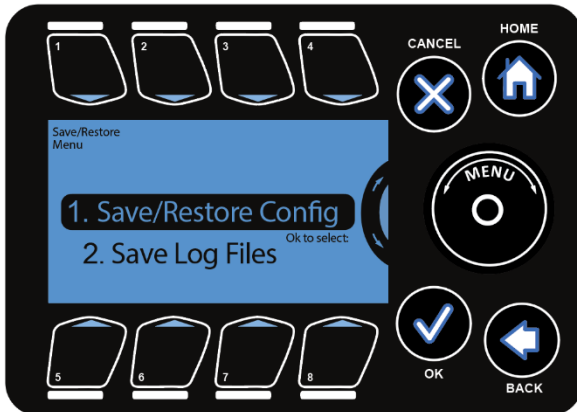

On selecting the **Save/Restore** button and pressing **OK** we get a menu to choose from.

**Save/Restore Config:** Store and restore the configuration file.

**Save Log Files:** Save the log file to USB.



## Save and Restore Configurations

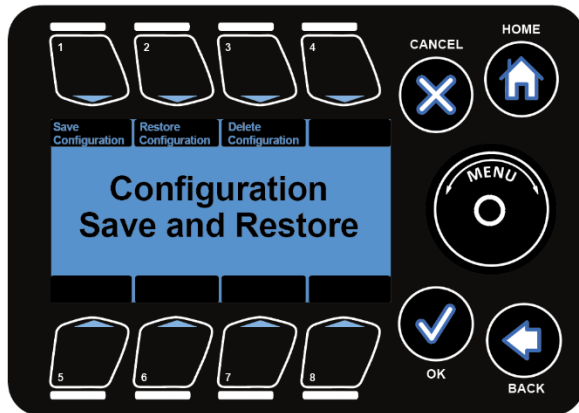

This option lets you label and store your program in either the internal memory of the iGrow 100 Series™ controller or a USB drive (jump drive).

You may have programs for different crops or for different seasons of the year. This will be a convenient way of storing your programs with the capability to restore the program whenever desired.

**Save Configuration:** Allows the user to store the controller settings/configuration to onboard memory/USB.

**Restore Configuration:** Allows the user to restore the configuration stored on the onboard system memory or USB.

**Delete Configuration:** Allows the user to delete the configuration files stored in system memory/USB.

**Buttons #1, #2 or #3** are used to go to the corresponding options.

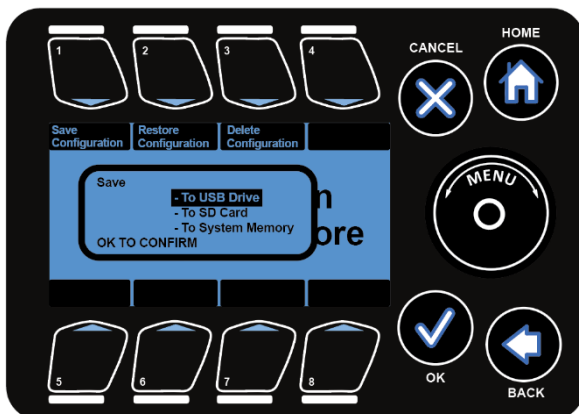

Once the user has selected what action they would like to perform, the system prompts for a destination to perform the action to.

Currently supported save/load devices include:

- SD Card
- USB Drive
- System Memory

Wheel is used to highlight the desired option and OK to go the option

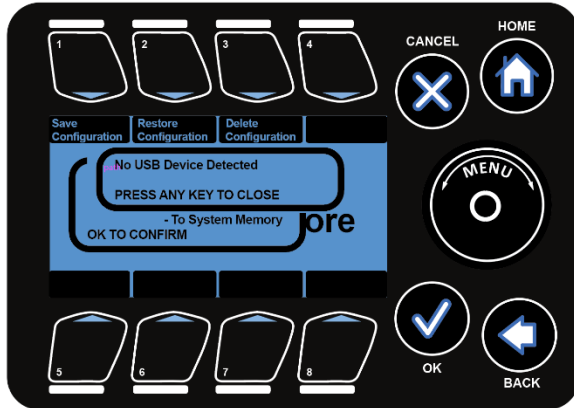

If a given drive is not present/connected the system gives an error popup indicating the same. In case the drive is busy a popup indicating device is busy is displayed.

Once a save/restore option is selected the user is prompted to enter the file name in the screen indicated below.

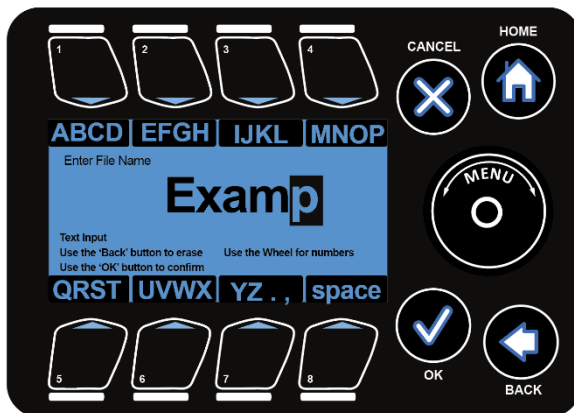

This screen is like the mobile phone SMS screen. To select a given alphabet press the required button the number of times = the position of the alphabet in the button. E.g. to type C press **Button #1** three times. To enter numbers, use the **Wheel**.

*Note: If a file with the same name already exists it will be overwritten during restore configuration.*

*Note: All configuration files are stored as .icf files.*

## Save Log Files



To save the log file select the Save Log Files option by highlighting it using the **Wheel** or by pressing **Button #2** and press **OK**.

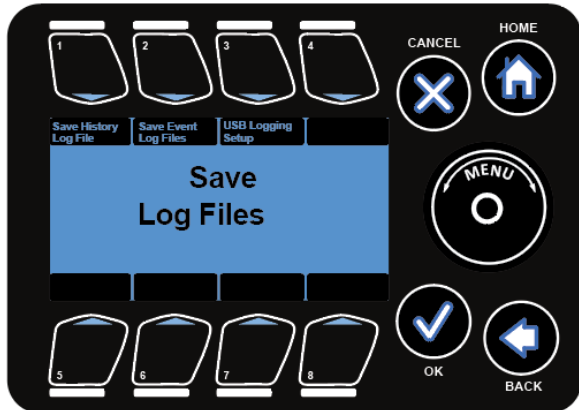

Currently supported Save Log File options include:

- Save History Log File
- Save Event Log Files
- USB Logging Setup

**Buttons #1, #2 or #3** are used to go to the corresponding options.

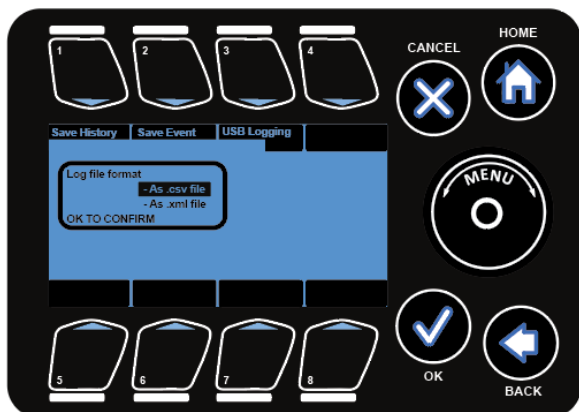

On selecting the Save History Log Files a popup indicating the file formats pop-ups. Log files can be saved in either .xml or .csv file formats.

Select a given format using **Wheel** and pressing **OK**.

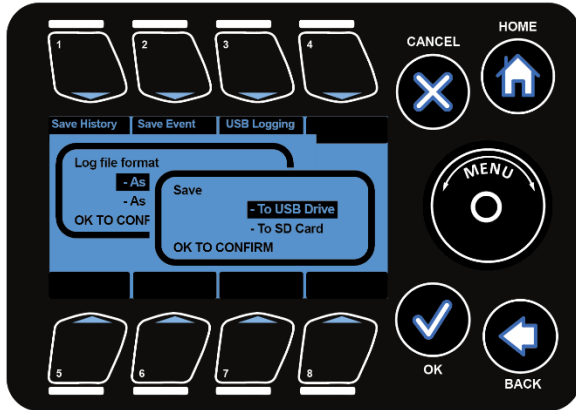

After selecting the required format, the user is promoted to choose the drive to store the file in.

User can select an option by scrolling and pressing **OK**.

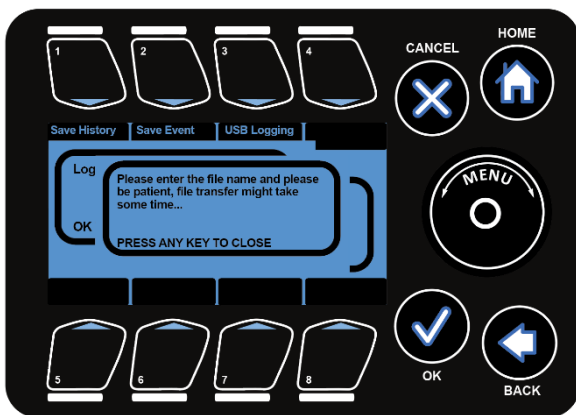

The system prompts the user to enter a file name.

*Note: The process of writing from system memory to USB can be time consuming.*

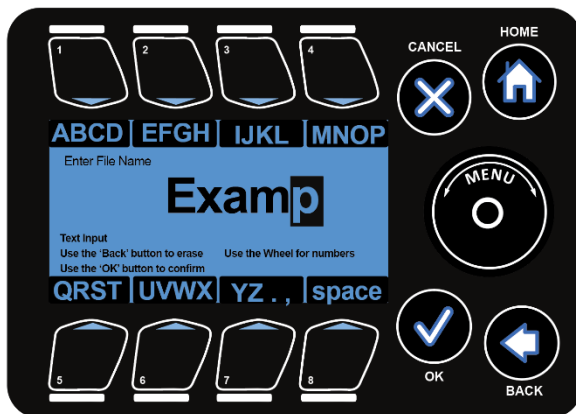

This screen is like the mobile phone SMS screen. To select a given alphabet press the required button the number of times = the position of the alphabet in the button. E.g. to type C press **Button #1** three times. To enter numbers, use the **Wheel**.

*Note: If a file with the same name already exists it will be overwritten.*

## Sensor Setup

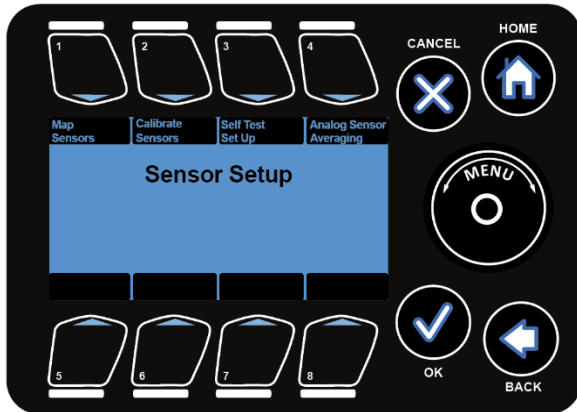

The Sensor Setup menu can be found under the System Setup menu.

Scroll to the appropriate line using the **Wheel** or quickly navigate by pressing **Button #3** and then **OK**.

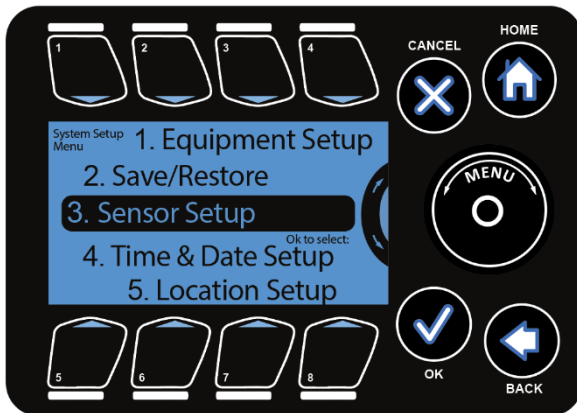

The Sensor Setup page is where the user can map the sensor that is used or inside temperature readings.

Sensors can also be calibrated and averaged in this section.

**Map Sensors:** This is where the user can set up the system according to the various sensors available.

**Calibrate Sensor:** The sensors can be calibrated to adjust for offsets/software setup here.

**Self-Test Setup:** This is where the diagnostic mode test setup for digital sensor is done.

**Analog Sensor Averaging:** This option allows the user to average the data from separate analog sensors.

**Buttons #1 - #4** are used to go to the corresponding options.

## Map Sensors

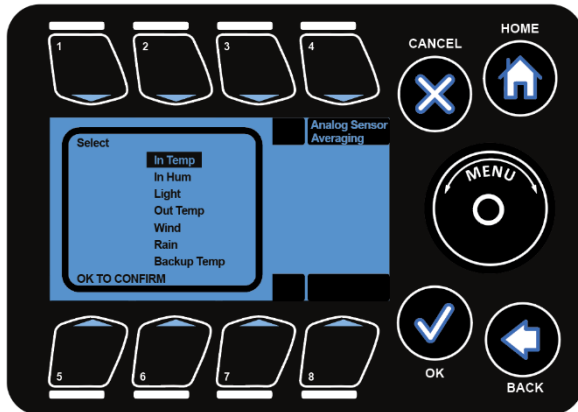

The mapping of the inputs to the different sensors is done here. The figure below shows the different inputs available for mapping.

**InTemp:** Inside Temperature sensor

**In Hum:** Inside Humidity sensor

**Light:** Light sensor

**OutTemp:** Outside temperature sensor

**Wind:** Wind direction and speed sensor

**Rain:** Rain sensor

**Back up Temp:** Back up temperature sensor

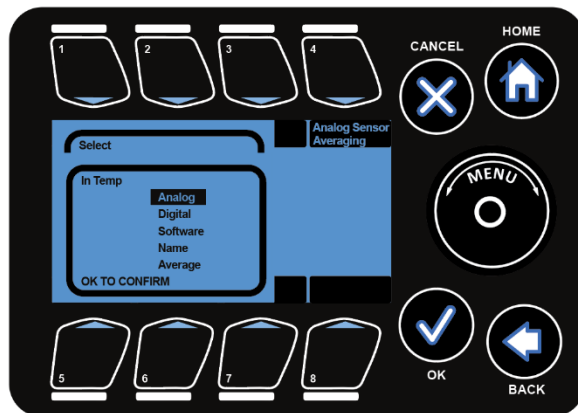

On selecting a given input you are presented with options to map that input to different sensors. You can also enable/disable that sensor.

E.g. if you are using an analog probe to measure the inside temperature then select analog for InTemp. If you do not have a particular sensor select None/Disabled for that sensor.

## Calibrate Sensors

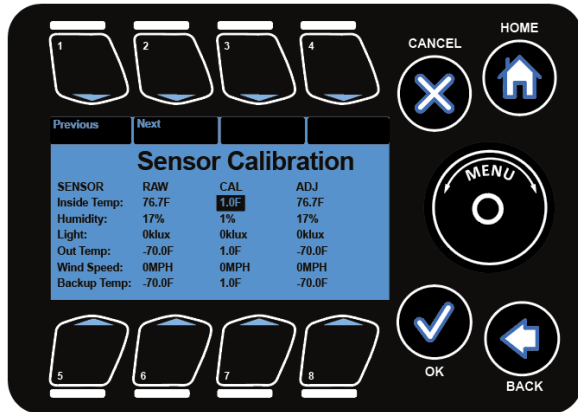

To calibrate an input the sensor is selected. The **Previous** and **Next** buttons are used to scroll through the different sensors.

**Raw Value:** This is the direct reading from the sensor.

**CAL:** This is the offset which will be added to raw value to generate the adjusted value (ADJ).

The **Wheel** can be used to increase and decrease the values.

**ADJ:** This is the value which will be reflected on the status screen.

## Self-Test Setup

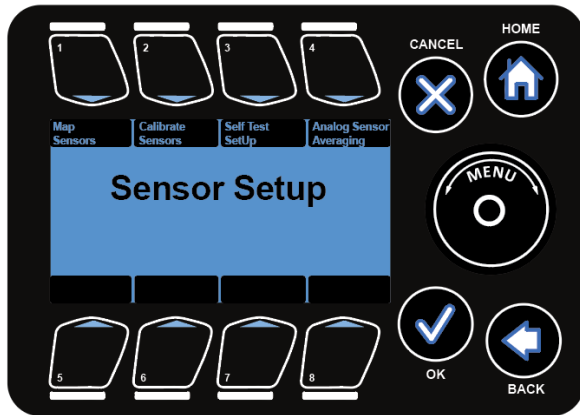

This section enables the user to set up the test parameters for automatic testing of the digital temperature sensors.

If a digital sensor is present and automatic testing of that sensor is desired, map the sensor to one of the digital values in the Map Sensors screen.

*Note: This section only applies to mapped digital sensors.*

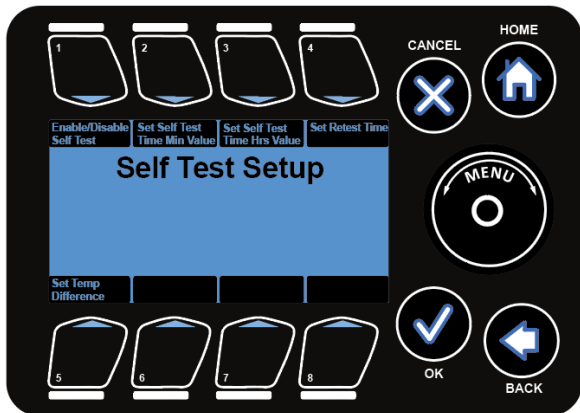

**Enable/Disable Test:** Sets the test to enabled or disabled. **Button #1** is used to go to this option

**Self-Test Time:** The time interval between planned sensor tests.

**Set Retest Time:** The delay after which a test should repeat once a previous test has failed.

**Button #4** is used to go to this option.

**Set Temp Difference:** Temperature difference which should be seen when the test is in progress. **Button #5** is used to go to this option.

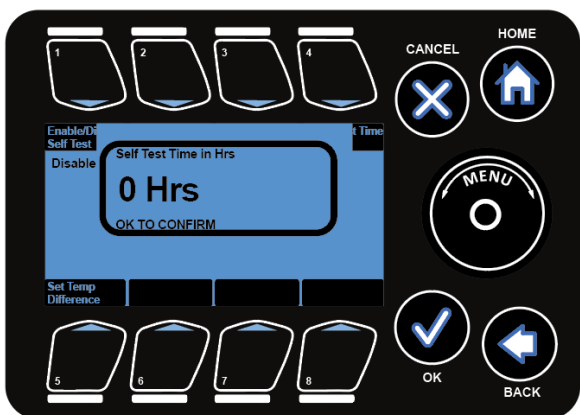

**Set Self-Test Time Min Value:** Adjusts the time in minutes.

**Set Self-Test Time Hrs Value:** Adjusts the time in hours.

**Buttons #2 and #3** are used to go to the corresponding option. **Wheel** can be used to increase or decrease the values.

*Note: If a sensor fails the test and no backup sensor is in place, significant crop damage can occur. It is the responsibility of the end user to maintain sensors in good working order.*



## Analog Sensor Mapping

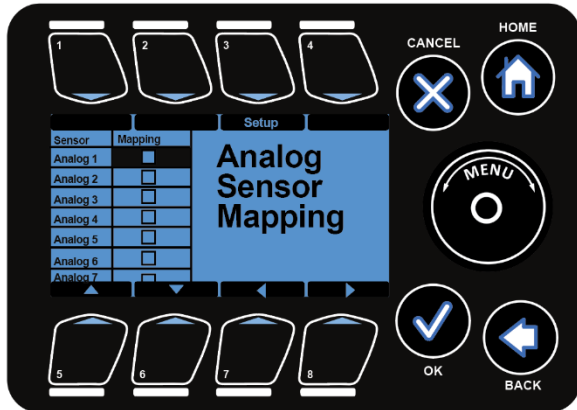

This section enables the user to average the data from separate analog sensors.

This is useful in situations where the user needs to take temperature data from multiple locations in a zone and average them to form an accurate temperature reading for the entire zone.

Use the **Arrows and Wheel** to navigate to a desired analog sensor and map it to be averaged using the **Enable/Disable** toggle or the OK button.

## Time and Date Setup

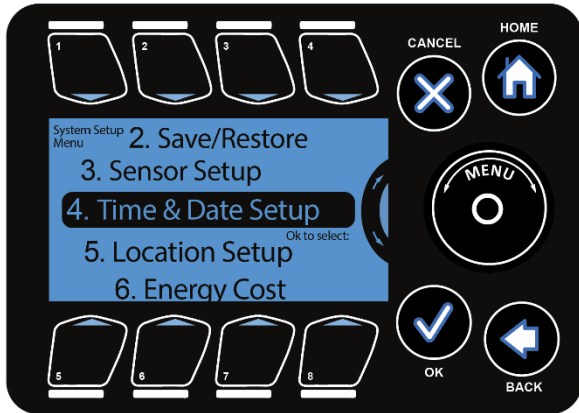

This section allows the user to change the time and date values on the 100 Series controller.

Time and Date setup menu can be found under system setup menu

**Wheel** or **Button #4** can be used to go to highlight this option and OK to select this option.

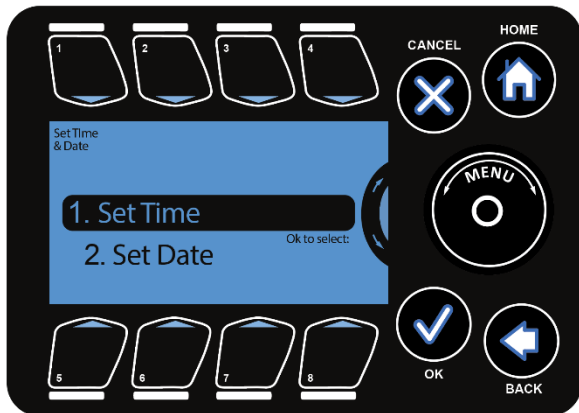

After selecting Time & Date Setup the user can choose to select either Set Time or Set Date from the menu.

Highlight your choice by using the **Wheel** or **Button #1 and #2** and press **OK** to go to the highlighted selection.

## Set Time

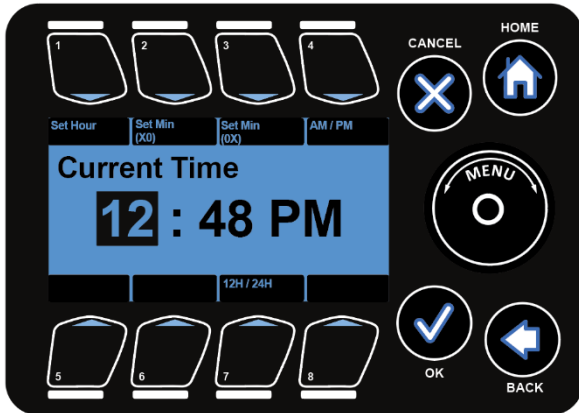

The time on the system clock can be adjusted by highlighting a chosen field (**Button #1, #2, #3**) and using the **Wheel** to modify the field value. If a given field is already highlighted repressing that button causes the value in that field to be increased.

**12H/24H:** Used to set the time display as 24 hr/12 hr duration.

**Set Hour:** Used to highlight the hour field.

**Set Min(X0):** Used to highlight the tens place of minutes value.

**Set Min(0X):** Used to highlight the single place of minutes value.

**AM/PM:** Used to set AM/PM value.

*Note: that when the clock is set to 24H, the AM/PM button increments the time by 12 hours.*

## Set Date



The date on 100 Series controller can be adjusted by highlighting a chosen field (**Button #1, #2, #3**) and using the **Wheel** to modify the field value. If a given field is already highlighted repressing that button causes the value in that field to be increased.

The date is displayed in MM/DD/YYYY format.

**Set Month:** Used to highlight the month field.

**Set Day:** Used to highlight the day field.

**Set Year:** Used to highlight the year field.

## Location Setup

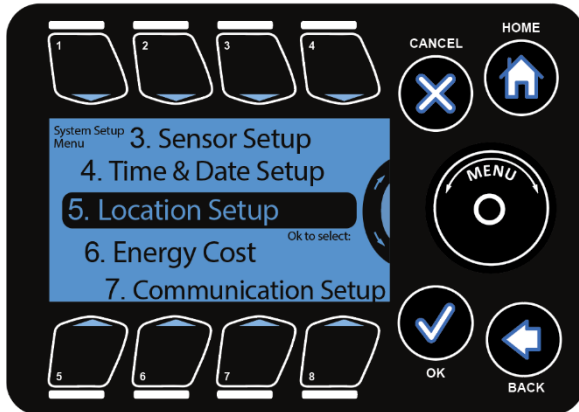

Location setup allows the user to setup the latitude and longitude values. The 100 Series controllers have an internal astronomical clock and can calculate the precise sunrise and sunset times once the location of the unit is entered.

Location setup menu can be found under system setup menu

**Wheel** or **Button #5** can be used to go to highlight this option and **OK** to select this option.

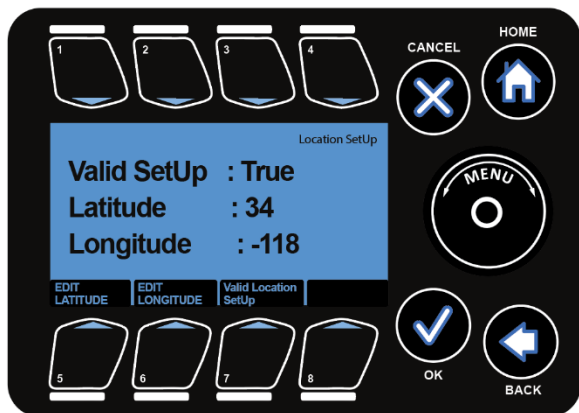

**EDIT LATITUDE:** Allows the user to edit the latitude value.

**EDIT LONGITUDE:** Allows the user to edit the longitude value.

**Valid Location Setup:** If set to False, indicates that the latitude and longitude values are incorrect and should be ignored. If set to true indicates that the coordinates are valid/correct and can be used for sunrise and sunset time calculations.

**Buttons #5, #6 and #7** can be used to go to the corresponding options.

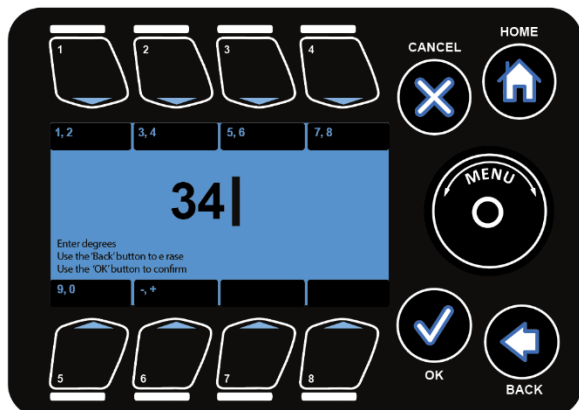

On selecting the edit option, the user is presented with the following screen.

For latitude:

"-": Means South

"+": Means North

For longitude:

"-": Means West

"+": Means East

*Note: If no sign is indicated it means +.*

## Energy Cost

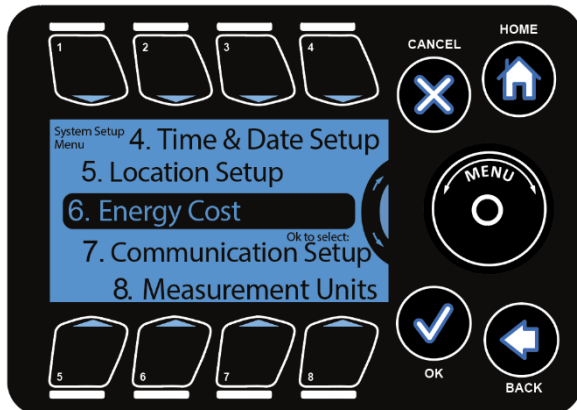

This is where the energy cost rates are entered for each of the energy/ water types.

Energy Cost setup menu can be found under system setup menu

**Wheel** or **Button #6** can be used to go to highlight this option and OK to select this option

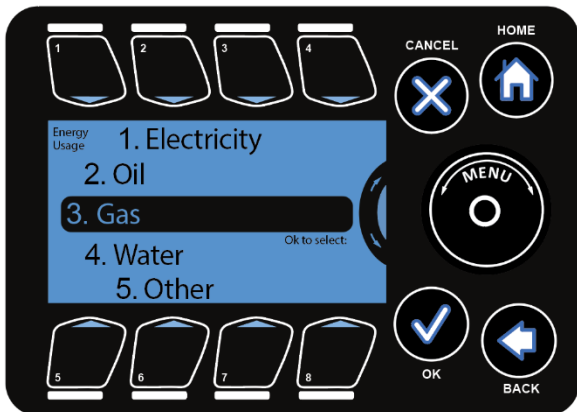

To select a given energy type highlight it using the **Wheel** or **Buttons #1 through #5** and press **OK**.

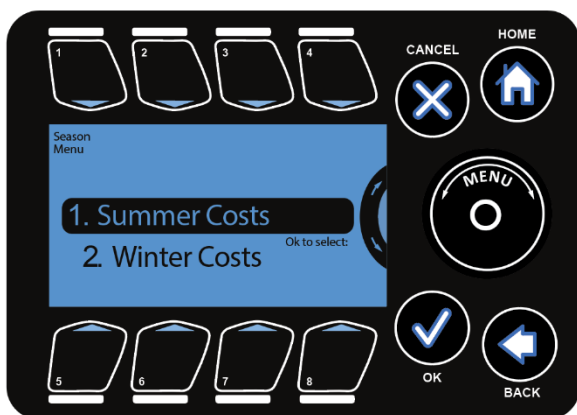

The energy cost for Electricity is entered according to the seasons:

- Summer Costs
- Winter Costs

To select a given season highlight it using the **Wheel** or **Buttons #1 or #2** and press **OK**.

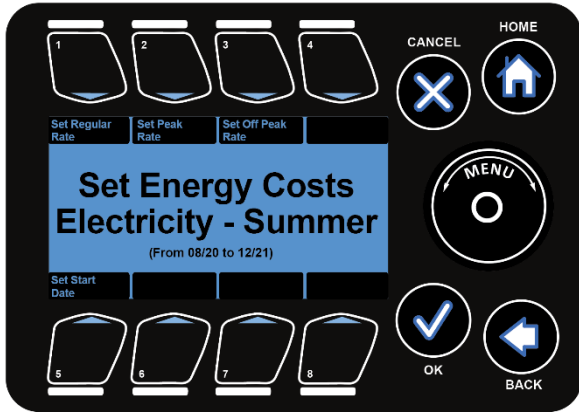

**Set Regular Rate/Set Peak Rate/Set Off Peak Rate:** Takes you to the screen where you can set the time of start of the rate and its cost per unit during that period.

**Set Start Date:** Takes you to a screen where you can set the starting date for a given season i.e. summer or winter.

**Buttons #1, #2, #3, and #5** can be used to go to the above-mentioned options.

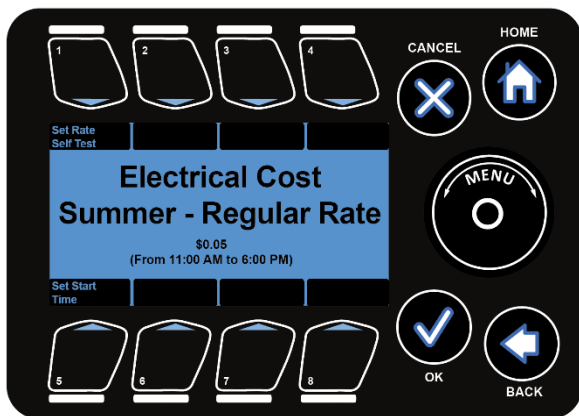

The figure shows the screen for rate setup and time set up for Regular Rate during summer.

**Button #1** can be used to select set rate option.

After selecting set Rate, the **Wheel** can be used to modify the rate vale.

**Button #5** can be used to select set start time option

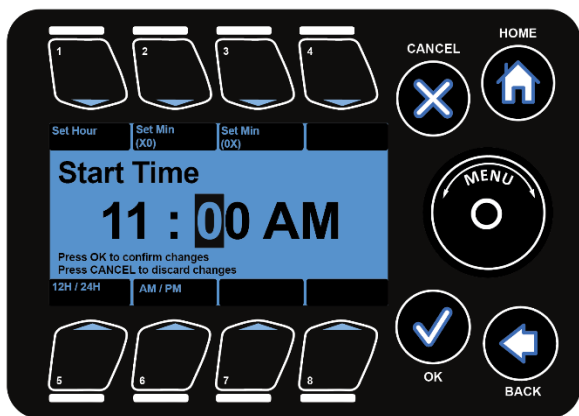

The figure shows the screen to set up the start time.

Use **Buttons #1 - #3** to highlight the field and use. **Button #6** can be used to change AM/PM. Wheel to change the values in the highlighted field.

The 24H clock can be triggered on/off with **Button #5**.

*Note: This screen works in the same way as the Set Time screens.*

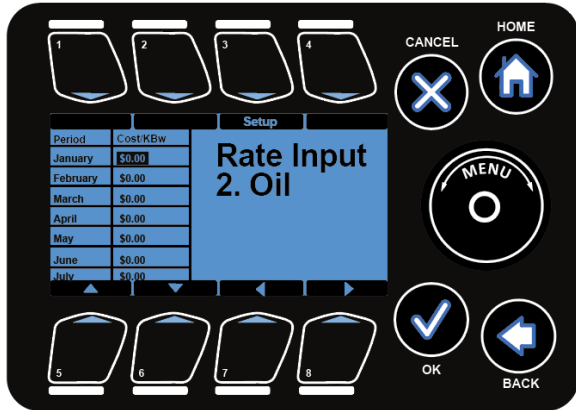

For energy types other than Electricity the cost of the resource for each month can be set.

The **arrows** are used to scroll through the selections and the **Setup** button.

**OK** button can be used to set the values.

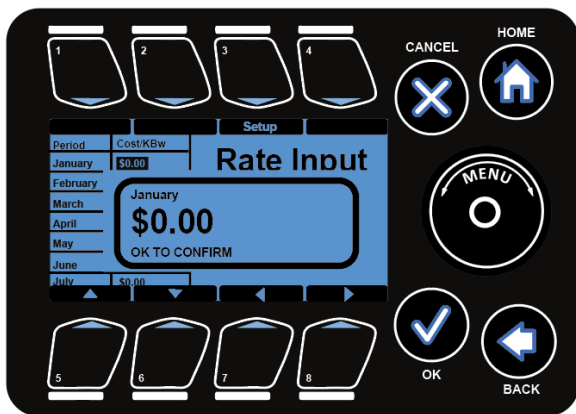

This figure displays the popup window which came up when **Setup (Button #3)/OK** button was pressed to modify the cost for month of January.

The **Wheel** is used to increase/decrease the selected value.



## Communication Setup

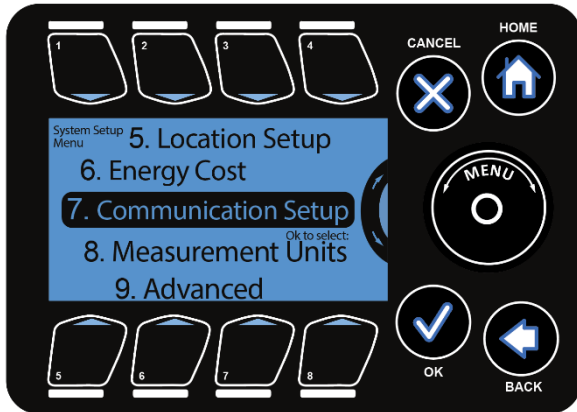

The Communication Setup screen can be accessed by navigating appropriate line in the System Setup Menu.

Communication setup menu can be found under system setup menu

**Wheel** or **Button #7** can be used to go to highlight this option and **OK** to select this option.

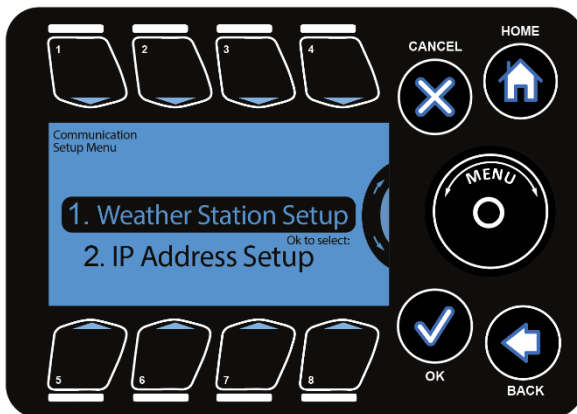

The Communication Setup Menu consists of Weather Station Setup and IP Address Setup.

**Weather Station Setup:** Allows the user to indicate whether a weather station is directly connected to the unit or through a networked unit.

**IP Address Setup:** Allows the user to configure the network settings to enable the unit for web access.

**Buttons #1, #2** or **Wheel** can be used to highlight the option and **OK** is used to select the option.

## Weather Station Setup

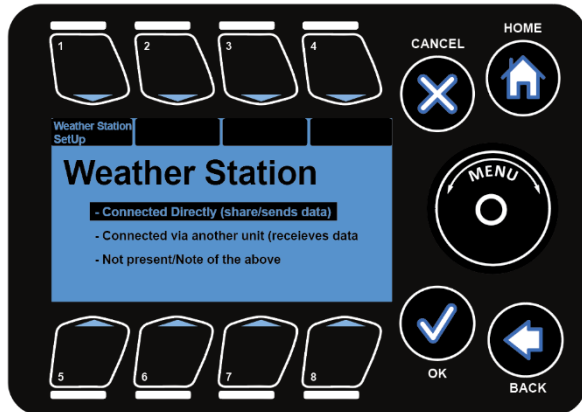

The Weather Station Setup menu is used to configure the unit to work with a Link4 Weather Station.

Pressing **Weather Station Setup** cycles through the three options.

**Connected Directly:** The weather station is wired directly into this unit. Selecting this option also enables the weather station data to be transmitted to other networked 100 Series controllers.

**Connected via Another Unit:** The weather station is wired into another 100 Series controllers. That unit can share weather station data to this and any other unit that is networked to it.

**Not present / None of the above:** There is no weather station data available.

## IP Address Setup

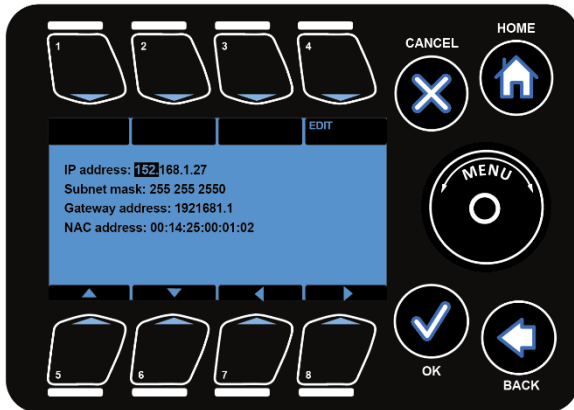

The IP Address setup is needed in case you need to access the unit using the web or a PC.

**IP Address:** This is the address that you will enter when you try to access the unit using a PC. This address must be a nonconflicting IP address and can be obtained from the network administrator.

**Subnet Mask:** This can be obtained from the PC used to access the unit or from your network administrator.

**Gateway Address:** This can be obtained from the PC used to access the unit or from your network administrator.

**MAC Address:** This is the MAC address of your unit. The MAC address is unique for each unit and cannot be edited.

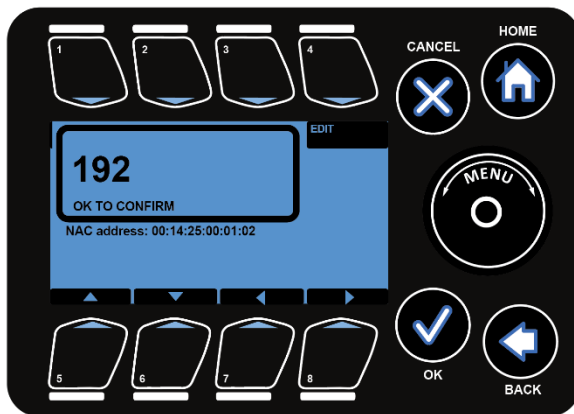

The **Arrow Buttons** are used to move the highlight. The **EDIT Button (Button #4)** is used to modify the highlighted item.

This figure displays the popup window which comes up when **EDIT Button** is pressed. The **Wheel** can be used to increase or decrease the value.

## Measurement Units

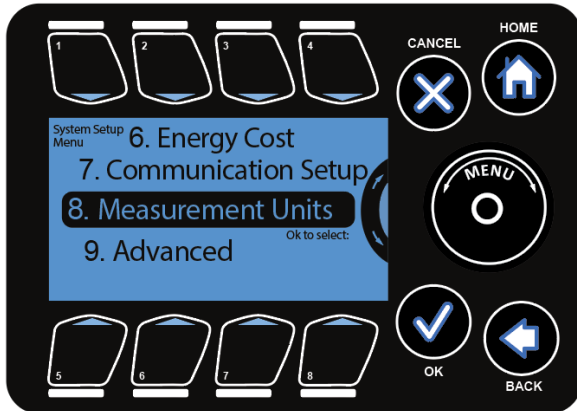

The units for temperature, wind speed, as well as light can be adjusted under the Measurement Units section of the System Setup.

Scroll the **Wheel** to the desired menu and select **OK**.

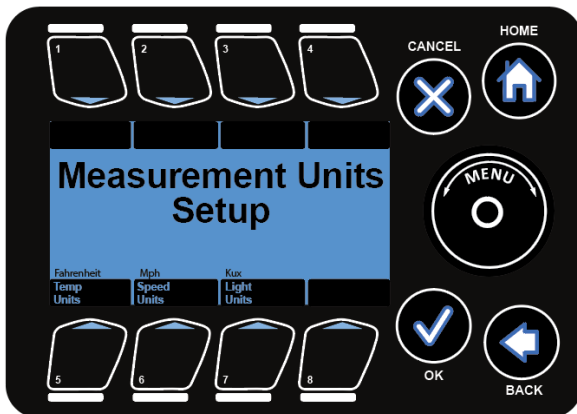

The units can be changed by pressing the buttons for the corresponding measurement (**Button #5, #6, #7**).

Pressing the buttons toggles the units.

**Temperature:** Choose either degree Fahrenheit (°F) or degree Centigrade (°C)

**Speed:** Choose either miles per hour (Mph) or kilometers per hour (kmph)

**Light:** Choose either Watts/meter<sup>2</sup> or Klux.

## Advanced

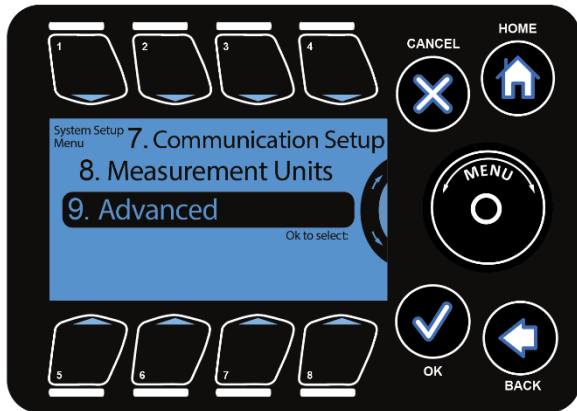

Advanced settings for the 100 Series controller can be configured under the Advanced section of the System Setup.

Scroll the **Wheel** to the desired menu and select **OK**.

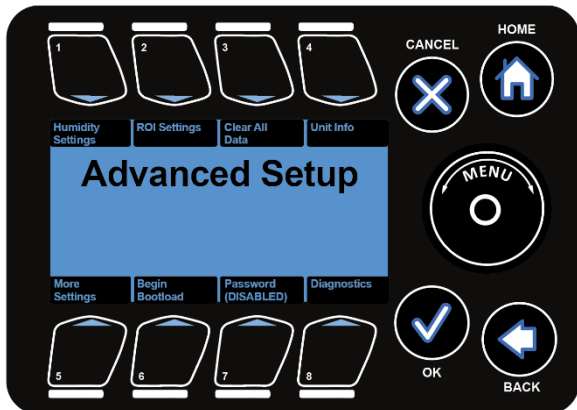

Press the button for the corresponding selection (**Button #1 - #8**) to enter the desired menu.

**Humidity Settings:** Used to set outside temperature override settings for humidity stages.

**ROI Settings:** Used to set the initial values for Return on Investment calculations.

**Clear All Data:** Formats the data flash and deletes all the log files on the unit.

**Unit Info:** Gives the general unit details.

**Stage Delay:** Used to set the delay between stage changes.

**Begin Bootload:** Used for firmware upgrade using bootloader.

**Password:** Used to set up password.

**UI Test:** Test the functionality of the touch sensitive user interface.

## Humidity Settings

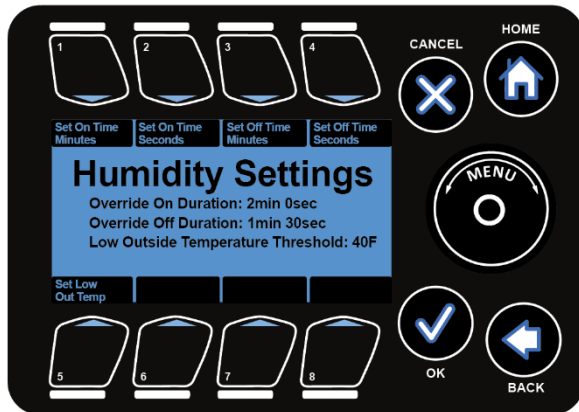

**Override On Duration:** The time for the override to remain active

**Override Off Duration:** The time for override to remain inactive/off

**Buttons #1 - #4** can be used to select override on/off. Wheel can be used to change the values.

**LowOut Temp:** If temperature falls below this value, override will trigger.

**Button 5** is used to select LowOut Temp option. Wheel can be used to change the values.

The Humidity settings are used to setup the system in case the outside temperature is low. This screen will specify some important parameters for your humidity control. With this screen you have the option of cycling the humidification and dehumidification stages. For example, suppose the zone humidity exceeds the humidity threshold. Without the cycling option, your system will remain in the dehumidification stage until the humidity falls below the dehumidification threshold by at least 2% RH. In some cases, it may be impossible to get below your humidity threshold. For these circumstances and for other cases, it would be helpful to cycle in and out of the humidity control override. This screen gives you the capability to do so.

The options are:

1. Set the override ON duration in minutes and seconds.
2. Set the override OFF duration in minutes and seconds.
3. Set a low temperature threshold.

The low temperature threshold is the outside temperature below which the dehumidification stage will revert to its Cold dehumidification state. For example, you may want to dehumidify but if it is very cold outside, you may want to turn on the heat instead of opening a vent and turning on a fan.

This humidity settings option can be useful in other applications even if you do not have a humidity sensor. For example, you may want to do misting control with a particular output, You can set up a "software" humidity sensor, a humidity time window and threshold so that the cycling will take place during your selected time period.

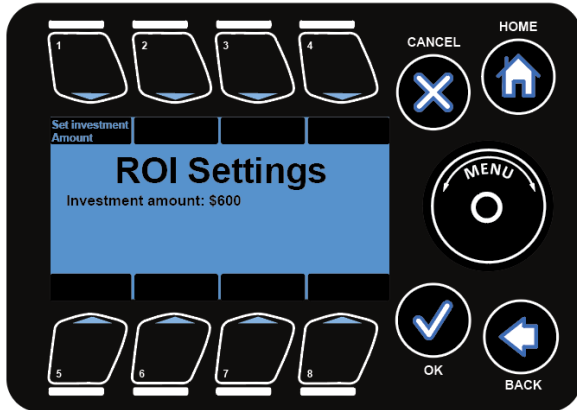

## ROI Settings

**Set Initial Amount:** The initial cost of the unit is entered here. This value is used to calculate the Return on Investment values.

**Button #1** can be used to highlight the option.

**Wheel** can be used to increase or decrease the value.

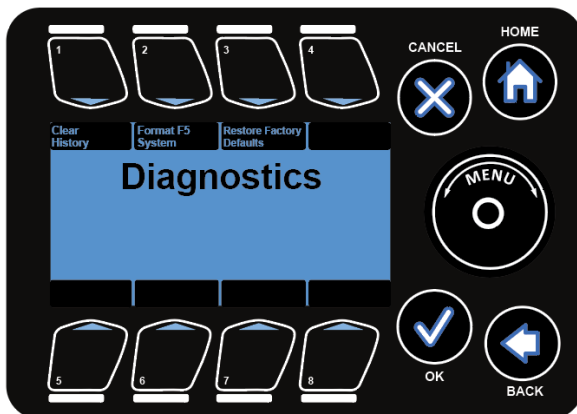

## Clear All Data

**Clear All Data:** This function is used to format the system memory (data flash).

**Button #3** can be used to highlight the option.

**Wheel** can be used to toggle between options.

Selecting yes deletes all the log files and web files stored on the unit's system memory.

*Note: This cannot be undone.*



## Unit Info

**Unit Info:** Use this function to display the firmware version number and the unit serial number.

**Button #4** can be used to highlight the option.

*Note: This is the same screen that loads on unit startup.*

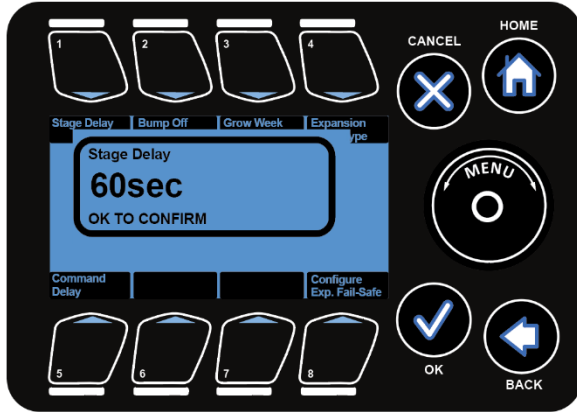

## Stage Delay

**Stage Delay:** This time setting in seconds is the shortest time permitted for switching between temperature stages. A typical value here would be 60 to 120 seconds. This parameter is useful in minimizing the cycling of your equipment. **Button #5** can be used to highlight timing option. **Button #1** is used to highlight State Delay Option. The **Wheel** is used to adjust the time values.

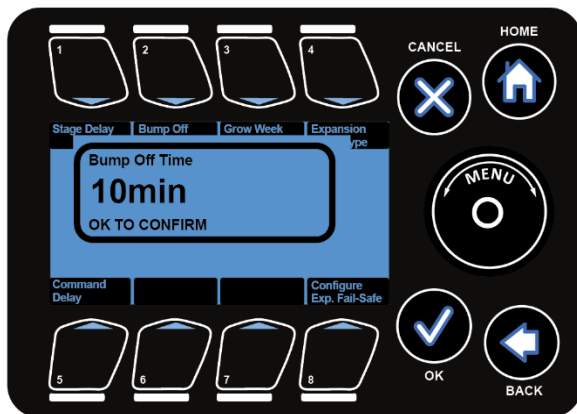

## Bump Off Time

**Button #5** can be used to highlight timing option. **Button #1** is used to highlight State Delay Option. The **Wheel** is used to adjust the time values.

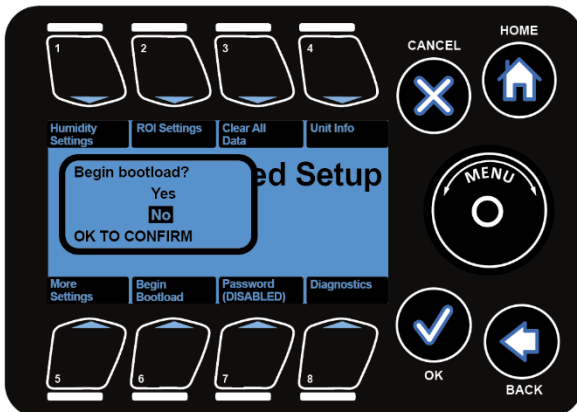

## Begin Bootload

**Begin Bootload:** This is used for firmware upgrade using the bootloader.

**Button #6** can be used to highlight the option. Wheel can be used to toggle between options.

*Note: Before doing a firmware update, a USB with correct binary file must be connected to the system.*

To come out from this mode press.



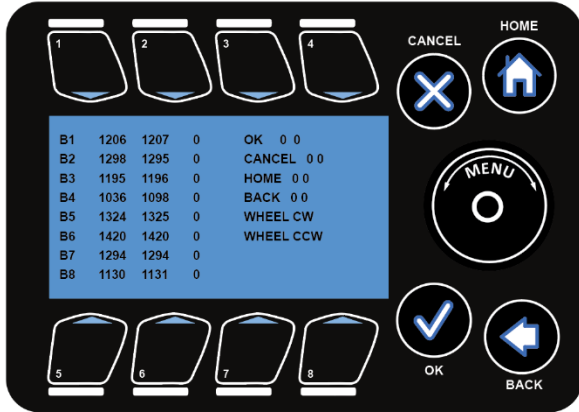

## UI Test

**UI Test:** This is a diagnostic mode used for testing if the buttons on the 100 Series controller are working correctly. Button #8 can be used to highlight the option. Wheel can be used to toggle between options.

Pressing a given button highlights it on the screen. The **Button #1 through #8** one after another.

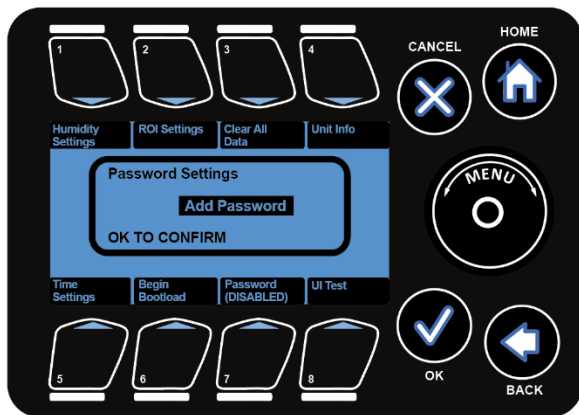

## Password

**Password:** This is used to set password for the use of controller.

*Note: Password option is in disabled position and need to change.*

**Button #7** can be used to highlight the option. To remove the password user, need to go to password option and use **Wheel** to disable the password. If user confirms then a new screen pops up. User need type in the password and confirm it.

## Stages

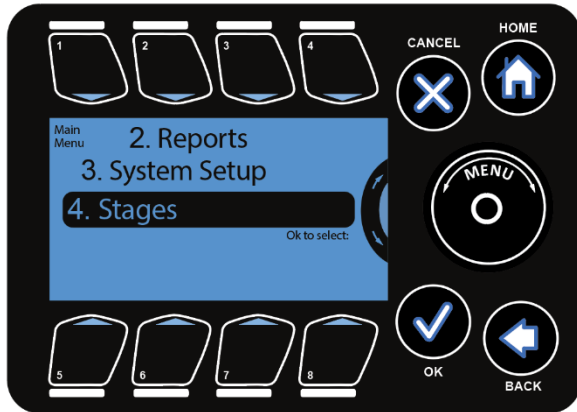

The last main section of the iGrow 100 Series™ controller is the Stages section. This section provides quick access to the staging options found under the Equipment Setup menu.

*Note: There are 8 temperature stages and 4 humidity stages.*

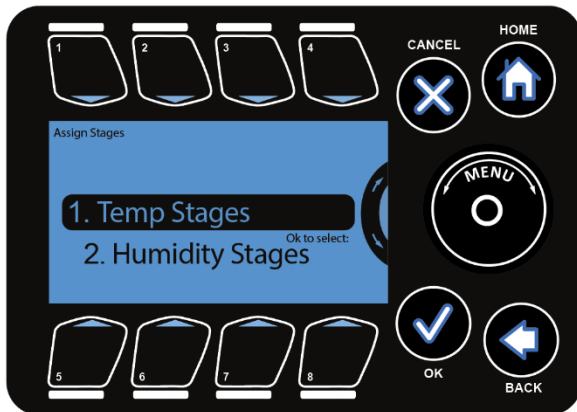

There are two subsections under Staging:

1. Temp Stages
2. Humidity Stages

**PLEASE REFER TO "ASSIGN STAGES" UNDER EQUIPMENT SETUP FOR DETAILED INSTRUCTIONS ON HOW TO SET UP STAGING (page 50).**

# Complete Menu Structure Listing

## 1. Setpoints

### 1.1. Temp Setpoint

#### 1.1.1. Set DAY

##### 1.1.1.1. SetHeat Setpoint

The Heat Setpoint is the low temperature target below which the heat stages are engaged.

##### 1.1.1.2. SetCool Setpoint

The Cool Setpoint is the high temperature target above which the cooling stages are invoked.

##### 1.1.1.3. Set Stage Separation

The Stage Separation is the temperature spacing between the stages. For example, when the temperature in the zone goes above the cool setpoint, the system will go into Cool 1. If the temperature continues to rise and goes above the Cool Setpoint and the Stage Separation temperature, then the system will go into Cool 2, and so forth.

##### 1.1.1.4. Set Time

###### 1.1.1.4.1. Set DAY Start Time

The DAY Start Time is time when the Day Set Points are engaged.

###### 1.1.1.4.1.1. Sun Based or Absolute (fixed)

The Start Time is either an absolute/fixed time or varies astronomically based on the day length. For the sun-based option, the start time will adjust each day from the date that the option is selected. The day length is an Astronomic adjustment based on the latitude and longitude entries that you made.

##### 1.1.1.5. Advanced

###### 1.1.1.5.1. Ramp Time

The Ramp Time enables a smooth transition of the target temperatures between the time periods. If the ramp time is set to 0, there will be an immediate step transition in the set points from the previous time window. If the ramp time is not 0, for example, if it is 30 minutes, then the setpoints will adjust gradually from one time to the next over the 30-minute time span.

###### 1.1.1.5.2. DeadBand

This is sometimes called "hysteresis band". For cooling, it is the number of degrees the temperature needs to drop from the lower boundary of its current stage before it switches to the lower stage.

<p><b>NOTE:</b> Without deadbands, equipment tends to cycle frequently and constantly change stages when the temperature reaches the setpoint or a stage boundary.</p>
--

For heating, it is the number of degrees the temperature needs to rise above the temperature boundary before it switches to a lower heating stage.

Typical values will be 1 to 2 degrees, Fahrenheit.

### 1.1.2. SetNIGHT

#### 1.1.2.1. On/Off

By selecting the On option, you will be able to program separate setpoints and other parameters for your defined nighttime period. The Off option disables this second set of setpoint parameters.

#### 1.1.2.2. SetHeat Setpoint

Same description as for Day

#### 1.1.2.3. SetCool Setpoint

Same description as for Day

#### 1.1.2.4. Set Stage Separation

Same description as for Day

#### 1.1.2.5. SetTime

##### 1.1.2.5.1. SetNIGHT Start Time

The Night Start Time is the time when the night setpoints are engaged.

##### 1.1.2.5.1.1. Sun Based or Absolute

Same description as for Day

#### 1.1.2.6. Advanced

##### 1.1.2.6.1. Ramp

Same description as for Day

##### 1.1.2.6.2. DeadBand

Same description as for Day

### 1.1.3. Set-DIF

DIF is short for Difference. This is a technique that some growers use to control the growth characteristics of certain plant types. The technique involves dropping the greenhouse temperature significantly an hour or two before sunrise. After sunrise, the temperature is raised gradually for an hour or so until the normal day time temperature target is achieved.

#### 1.1.3.1. On/Off

By selecting the On option, you will be able to program separate setpoints and other parameters for your defined DIF time. The Off option disables this third set of setpoint parameter

- 1.1.3.2. SetHeat Setpoint - Same description as for Day
- 1.1.3.3. SetCool Setpoint - Same description as for Day
- 1.1.3.4. Set Stage Separation - Same description as for Day
- 1.1.3.5. Set Time
  - 1.1.3.5.1. Set DIF Start Time

The DIF Start Time is the time when the DIF setpoints are engaged.

- 1.1.3.5.1.1. Sun Based or Absolute

Same description as for Day

- 1.1.3.6. Advanced
  - 1.1.3.6.1. Ramp – Same description as for Day
  - 1.1.3.6.2. DeadBand – Same description as for Day

## 1.2. Humidity Setpoint

### 1.2.1. Set-DAY

- 1.2.1.1. Set Humidity Setpoint

The Humidity Setpoint is the low humidity target below which the humidification stage is engaged.

- 1.2.1.2. Set Dehumidify Setpoint

The Dehumidify Setpoint is the high humidity target above which the dehumidification stages are engaged.

- 1.2.1.3. Set Time
  - 1.2.1.3.1. Set DAY Start Time

This is the time that the Day Humidity Setpoints are invoked.

- 1.2.1.3.1.1. Sun Based or Absolute

The start time is either a fixed (absolute) time or it can vary daily based on the increase or decrease in day length. The day length is an Astronomic Adjustment based on the latitude and longitude entries that you made.

- 1.2.1.4. Advanced
  - 1.2.1.4.1. Ramp Time

The Ramp Time enables a smooth transition between the humidity targets. If the ramp time is set to 0, there will be an immediate step transition in the humidity setpoints from the previous to the current setpoint of the following period. If the ramp time is not zero, the ramping begins at the end of the period.

- 1.2.1.4.2. DeadBand

For the dehumidification case, this is the humidity drop below the dehumidification boundary where the dehumidification stage terminates.

For the humidification case this the humidity increases above the humidification boundary where the humidification stage terminates.

## 2.2.1. Set-NIGHT

### 1.2..1. On/Off

The default for the night humidity setpoint is OFF. Pressing the tab will enable the setting of a nighttime humidity setpoint.

### 1.2..2. Set Humidify Setpoint

Use the scroll to set the low (humidity) setpoint. You can also set it at 0.

### 1.2..3. Set Dehumidify Setpoint

Pressing the second tab from the left on the bottom of the display will let you set the upper humidity setpoint. This is the de-humidification setpoint.

### 1.2..4. Set Time

This is the time that the night setpoints are invoked.

#### 1.2.4.1. Set NIGHT Start Time

##### 1.2.4.1.1. Sun Based or Absolute

The start time is either a fixed (absolute) time or it can vary daily based on the increase or decrease in day length. The day length is an Astronomic Adjustment based on the latitude and longitude entries that you made.

### 1.2..5. Advanced

#### 1.2.5.1. Ramp

The Ramp Time enables a smooth transition between the humidity targets. If the ramp time is set to 0, there will be an immediate step transition in the humidity setpoints from the previous to the current setpoint of the following period. If the ramp time is not zero, the ramping begins at the end of the period.

#### 1.2.5.2. DeadBand

For the dehumidification case, this is the humidity drop below the dehumidification boundary where the dehumidification stage terminates.

For the humidification case this the humidity increases above the humidification boundary where the humidification stage terminates.

## 2.2.1. Set-DIF

DIF is a third time window in a 24-hour period that you can elect to use to control the humidity separately from the other two periods.

### 1.2..1. On/Off

The default for the DIF humidity setpoint is OFF. Pressing the tab will enable the setting of a DIF time humidity setpoint.

#### 1.2..2. Set Humidify Setpoint

The Humidify Setpoint is the low humidity target below which the humidification stage is engaged during the DIF time.

#### 1.2..3. Set Dehumidify Setpoint

The Dehumidify Setpoint is the high humidity target above which the dehumidification stages are engaged during the DIF time.

#### 1.2..4. Set Time

##### 1.2..4.1. Set DIF Start Time

##### 1.2..4.2. ???

This is the time that the DIF setpoints are invoked.

##### 1.2..4.2.1. Sun Based or Absolute

The start time is either a fixed (absolute) time or it can vary daily based on the increase or decrease in day length. The day length is an Astronomic Adjustment based on the latitude and longitude entries that you made.

#### 1.2..5. Advanced

##### 1.2..5.1. Ramp

The Ramp Time enables a smooth transition between the humidity targets. If the ramp time is set to 0, there will be an immediate step transition in the humidity setpoints from the previous to the current setpoint of the following period. If the ramp time is not zero, the ramping begins at the end of the period

##### 1.2..5.2. DeadBand

For the dehumidification case, this is the humidity drop below the dehumidification boundary where the dehumidification stage terminates.

For the humidification case this the humidity increases above the humidification boundary where the humidification stage terminates.

## 2. Reports

- 2.1. Return on Investment
- 2.2. Equipment Costs
  - 2.2.1. Since Reset
  - 2.2.2. Last Hour
  - 2.2.3. Last 24 Hours
  - 2.2.4. Last 7 Days
  - 2.2.5. Last 30 Days
  - 2.2.6. This Month
  - 2.2.7. This year
- 2.3. Energy Costs
  - 2.3.1. Since Reset
  - 2.3.2. Last Hour
  - 2.3.3. Last 24 Hours
  - 2.3.4. Last 7 Days
  - 2.3.5. Last 30 Days
  - 2.3.6. This Month
  - 2.3.7. This Year
- 2.4. Equipment Usage
  - 2.4.1. Channel 1
    - 2.4.1.1. Since Reset
    - 2.4.1.2. Last Hour
    - 2.4.1.3. Last 24 Hours
    - 2.4.1.4. Last 7 Days
    - 2.4.1.5. Last 30 Days
    - 2.4.1.6. This Month
    - 2.4.1.7. This Year
  - 2.4.2. Channel 2
    - 2.4.2.1. Since Reset
    - 2.4.2.2. Last Hour
    - 2.4.2.3. Last 24 Hours
    - 2.4.2.4. Last 7 Days
    - 2.4.2.5. Last 30 Days
    - 2.4.2.6. This Month
    - 2.4.2.7. This Year
  - 2.4.3. Channel 3
    - 2.4.3.1. Since Reset
    - 2.4.3.2. Last Hour
    - 2.4.3.3. Last 24 Hours
    - 2.4.3.4. Last 7 Days
    - 2.4.3.5. Last 30 Days
    - 2.4.3.6. This Month
    - 2.4.3.7. This Year



- 2.4.4. Channel 4
  - 2.4.4.1. Since Reset
  - 2.4.4.2. Last Hour
  - 2.4.4.3. Last 24 Hours
  - 2.4.4.4. Last 7 Days
  - 2.4.4.5. Last 30 Days
  - 2.4.4.6. This Month
  - 2.4.4.7. This Year
- 2.4.5. Channel 5
  - 2.4.5.1. Since Reset
  - 2.4.5.2. Last Hour
  - 2.4.5.3. Last 24 Hours
  - 2.4.5.4. Last 7 Days
  - 2.4.5.5. Last 30 Days
  - 2.4.5.6. This Month
  - 2.4.5.7. This year
- 2.4.6. Channel 6
  - 2.4.6.1. Since Reset
  - 2.4.6.2. Last Hour
  - 2.4.6.3. Last 24 Hors
  - 2.4.6.4. Last 7 Days
  - 2.4.6.5. Last 30 Days
  - 2.4.6.6. This Month
  - 2.4.6.7. This Year
- 2.4.7. Channel 7
  - 2.4.7.1. Since Reset
  - 2.4.7.2. Last Hour
  - 2.4.7.3. Last 24 Hours
  - 2.4.7.4. Last 7 Days
  - 2.4.7.5. Last 30 Days
  - 2.4.7.6. This Month
  - 2.4.7.7. This Year
- 2.4.8. Channel 8
  - 2.4.8.1. Since Reset
  - 2.4.8.2. Last Hour
  - 2.4.8.3. Last 24 Hours
  - 2.4.8.4. Last 7 Days
  - 2.4.8.5. Last 30 Days
  - 2.4.8.6. This Month
  - 2.4.8.7. This Year
- 2.5. Energy Usage
  - 2.5.1. Electricity
    - 2.5.1.1. Since Reset

- 2.5.1.2. Last Hour
- 2.5.1.3. Last 24 Hours
- 2.5.1.4. Last 7 Days
- 2.5.1.5. Last 30 Days
- 2.5.1.6. This Month
- 2.5.1.7. This Year
- 2.5.2. Oil
  - 2.5.2.1. Since Reset
  - 2.5.2.2. Last Hour
  - 2.5.2.3. Last 24 Hours
  - 2.5.2.4. Last 7 Days
  - 2.5.2.5. Last 30 Days
  - 2.5.2.6. This Month
  - 2.5.2.7. This Year
- 2.5.3. Gas
  - 2.5.3.1. Since Reset
  - 2.5.3.2. Last Hour
  - 2.5.3.3. Last 24 Hours
  - 2.5.3.4. Last 7 Days
  - 2.5.3.5. Last 30 Days
  - 2.5.3.6. This Month
  - 2.5.3.7. This Year
- 2.5.4. Water
  - 2.5.4.1. Since Reset
  - 2.5.4.2. Last Hour
  - 2.5.4.3. Last 24 Hours
  - 2.5.4.4. Last 7 Days
  - 2.5.4.5. Last 30 Days
  - 2.5.4.6. This Month
  - 2.5.4.7. This Year
- 2.5.5. Other
  - 2.5.5.1. Since Rest
  - 2.5.5.2. Last Hour
  - 2.5.5.3. Last 24 Hours
  - 2.5.5.4. Last 7 Days
  - 2.5.5.5. Last 30 Days
  - 2.5.5.6. This Month
  - 2.5.5.7. This Year

## 3. System Setup

### 3.1. Equipment Setup

#### 3.1.1. Channel 1

##### 3.1.1.1. Override

This feature lets you manually override your greenhouse equipment for specified periods of time, either once or daily.

##### 3.1.1.1.1. Enable/Disable

Enable lets the override operate. Disable disallows the override but maintains the other user entries.

##### 3.1.1.1.2. Force ON/OFF

You can select whether you want to force (override) the on/off equipment either On or Off and the proportional equipment such as vents and curtains to a particular position based on percentage open for a vent and percent covered for a curtain.

##### 3.1.1.1.3. Override Duration

###### 3.1.1.1.3.1. Start Time

Select the time of day you want the override to begin.

###### 3.1.1.1.3.2. Duration

Select the On or Off override time in hours and minutes.

###### 3.1.1.1.3.3. Daily/One time

If "Daily" is selected, the override will occur every day at the Start Time. If "One time" is selected, once the override is completed, it will not occur again without being reset to On.

##### 3.1.1.2. Initial Settings

This is where you go for the first time to define the type of equipment on each channel that you are using and to name the channel.

##### 3.1.1.2.1. Set Type

There are three types (classes) of equipment that you can program. One is On/Off and the other two are "proportional" or Vents and Curtains.

###### 3.1.1.2.1.1. General Type

Select this option when you want to setup the channel

###### 3.1.1.2.1.1.1. ON/OFF

On/Off equipment such as fans, louvers, heaters, etc., are sometimes referred to as digital outputs. This equipment type occupies only one channel and can be programmed on any channel.

### 3.1.1.2.1.1.2. Vent

A vent with a drive open and drive close relay requires two consecutive channels. The first must be an odd number and the second, its neighbor to the right, an even number. Acceptable pairs are 1 & 2, 3 & 4, 5 & 6, and 7 & 8. The odd numbered channel opens the vent, the even number closes the vent.

A vent is a proportional device, sometimes referred to as a "timed analog output".

#### 3.1.1.2.1.1.2.1. Open to Close Time

##### 3.1.1.2.1.1.2.1.1. Set Open Time

The "Open Time" is the time in minutes and seconds that it takes for the vent to go from its full close position to fully open position.

#### 3.1.1.2.1.1.2.2. Setup Overrides

This section assumes that you have outside sensors such as a rain sensor, wind speed and direction sensor and/or an outside temperature sensor. These are typically part of a weather station assembly but can be obtained separately.

##### 3.1.1.2.1.1.2.2.1. Rain

Set Vent Open Limit - this sets a limit on the maximum open position for the vent when the sensor detects rain.

##### 3.1.1.2.1.1.2.2.2. Wind

Set Vent Open Limit

This is the maximum percent open for the vent when the wind speed exceeds the limit set next. The program calculates the average wind speed over the last 3 seconds. This is to eliminate responding to short wind gusts.

Set Wind Speed Limit

This is the wind speed at which the vent will be closed to the Vent Open Limit previously programmed. The wind override ends when the wind speed falls below the threshold for two minutes.

##### 3.1.1.2.1.1.2.2.3. Outside Temp

If it is very cold outside you may want to limit the percentage opening of the vent regardless of the inside zone temperature.

Set Vent Open Limit

This is the maximum percent open for the vent when the outside temperature falls below the threshold set in the next entry. ss

## Set Temp Limit

This is the outside temperature below which the vent will not exceed the maximum percent open assigned in the previous entry.

### 3.1.1.2.1.1.3. Curtain

#### 3.1.1.2.1.1.3.1. Set Day Mode Light Threshold

This option assumes that you have a light sensor either outside or above the curtain. The "Light Threshold" is the light level above which the curtain will be covered to the percentage specified in the next entry.

#### 3.1.1.2.1.1.3.2. Set Day Mode Covered %

This is the maximum position for closing the curtain during the day. This is particularly important if you are dependent on the ridge vents for cooling.

#### 3.1.1.2.1.1.3.3. Set Day Mode Start Time

This is the starting time when the curtain will be subject to the light threshold. If the light level is below the light threshold the curtain will remain uncovered.

#### 3.1.1.2.1.1.3.4. Set Day Mode End Time

This is the ending time for the day mode of the curtain.

#### 3.1.1.2.1.1.3.5. Set Open Delay Time

The purpose of this parameter is to reduce the curtain movement. The light level must be below the "Light Threshold" for at least this many minutes before the curtain will open.

#### 3.1.1.2.1.1.3.6. Enable Shock Protection

Enabling Shock Protection forces the curtain to open slowly in the morning when the outside temperature is below a certain threshold. This is to avoid the in-rush of cold air that may be above the energy curtain. In the morning when the curtain is scheduled to open and if the outside temperature is below deg, the curtain will open in four steps.

It will open 5% and then pause for 5 minutes. It will repeat this 4 times and then open to 0% without stopping.

#### 3.1.1.2.1.1.3.7. Set Open-Close Time

This is the time it takes for the curtain to go from its uncovered position 0% closed to its covered position, 100% closed. Enter the time in minutes and seconds.

### 3.1.1.2.1.1.4. Alarm

Any one of the available 8 channels can be selected to be an alarm output. When an alarm condition is met, the digital output (relay) is closed.

#### 3.1.1.2.1.1.4.1. Toggle Alarm Type

There are two temperature alarm settings that can be programmed. One is a High temp alarm; the other is a Low Temp alarm. Pressing the top left Tab enables you to toggle the programming screens between the two options.

#### 3.1.1.2.1.1.4.2. Set Temperature

This Tab lets you select the temperature threshold above or below which the alarm will be triggered.

#### 3.1.1.2.1.1.4.3. Set Wait Time

This Tab lets to set a wait time before the alarm is triggered. This time can be set from 0 to 99 minutes. The alarm condition must exist during the entire wait time for the alarm condition to be met. If the temperature drops below the threshold during the wait time, the clock will be reset to 0.

### 3.1.1.2.1.2. Energy Type

#### 3.1.1.2.1.2.1. Electricity

##### 3.1.1.2.1.2.1.1. Measured

3.1.1.2.1.2.1.1.1. Voltage

3.1.1.2.1.2.1.1.2. Phase Amps

3.1.1.2.1.2.1.1.3. Power Factor

3.1.1.2.1.2.1.1.4. Status

3.1.1.2.1.2.1.1.5. Estimated Voltage

##### 3.1.1.2.1.2.1.2. HP/kW/Amps Motor

3.1.1.2.1.2.1.2.1. Efficiency

3.1.1.2.1.2.1.2.2. Operational Load

3.1.1.2.1.2.1.2.3. Status

##### 3.1.1.2.1.2.2. Oil

3.1.1.2.1.2.2.1. BTUs/h Status

##### 3.1.1.2.1.2.3. Gas

3.1.1.2.1.2.3.1. BTUs/h Status

##### 3.1.1.2.1.2.4. Water

3.1.1.2.1.2.4.1. Gallon/min

3.1.1.2.1.2.4.2. Status

##### 3.1.1.2.1.2.5. Other

3.1.1.2.1.2.5.1. Units/h

3.1.1.2.1.2.5.2. Status

### 3.1.1.2.2. Set Name

You can program a custom name for each piece of equipment connected to the iGrow. The alphanumeric display lets you enter text much like you would on a cell phone. You have up to nine (9) positions that you can use.

### 3.1.1.3. Assign Stage

Select either the temperature stages or the humidity stages.

### 3.1.1.3.1. Temp Stages

#### 3.1.1.3.1.1. 1. "Channel" stages

This selection lets you program the channel that you have chosen.

#### 3.1.1.3.1.2. 2. "All Equipment Stages"

This selection gives you a table with each piece of equipment in the left column and each stage of heating and cooling across the top. It gives a quick overview of how you have programmed each piece of equipment. It also gives you the option of programming in a single location any or all the equipment for temperature control.

### 3.1.1.3.2. Humidity Stages

#### 3.1.1.3.2.1. 1. "Channel" Stages

This selection lets you program the channel that you have chosen.

#### 3.1.1.3.2.2. 2. "All Equipment Stages"

This selection gives you a table with each piece of equipment in the left column and each humidity stage across the top. It gives a quick overview of how you have programmed each piece of equipment. It also gives you the option of programming in a single location any or all the equipment for humidity control.

##### 3.1.1.3.2.2.1. Humidify

When the zones humidity goes below the low humidity setpoint, this engages the humidity or humidification stage.

Equipment programmed at the controller can be activated or de-activated, as desired, when this stage is triggered. Another option for each piece of equipment is N/A, which means no particular action is taken with that equipment in the humidify stage.

##### 3.1.1.3.2.2.2. De-Humidify

When the zones humidity goes above the high humidity setpoint, this engages the dehumidification stage.

Equipment programmed at the controller can be activated or de-activated, as desired, when this stage is triggered. Another option for each piece of equipment is N/A, which means no particular action is taken with that equipment in the humidify stage.

##### 3.1.1.3.2.2.3. De-Humidify (Cold)

When the zones humidity goes above the high humidity setpoint and the outdoor temperature goes below xx deg, the "Cold De-humidification" stage is engaged. Equipment programmed at the controller can be activated or de-activated, as desired, when this stage is triggered. Another option for each piece of equipment is N/A, which means no particular action is taken with that equipment in this stage.

## 3.2. Save/Restore

---

This option lets you label and store your program in either the internal memory of the iGrow, to a USB drive (jump drive), and/or an SD card. You may have programs for different crops or for different seasons of the year. This will be a convenient way of storing your programs with the capability to restore the program whenever desired.

#### 3.2.1. Save Configuration

Pressing the Save Configuration key will bring up the save to option. Clearly, if you are going to save to a USB drive or an SD card you will need to have placed either of these devices inside your iGrow. After making your selection you will be given the option of labeling the file with up to nine alphanumeric.

#### 3.2.2. Restore Configuration

Pressing this key will bring up the "restore from" option. You must select one of the three options from which to extract the file. The file you select will then replace the one you currently are using.

#### 3.2.3. Delete Configuration

Pressing this key will bring up the "delete from" option. You must select one of the options from which to remove the file. The file will then be permanently deleted.

### 3.3. Sensor Setup

#### 3.3.1. Map Sensors

#### 3.3.2. Calibrate Sensors

#### 3.3.3. Self-Test Setup

#### 3.3.4. Analog Sensor Average

### 3.4. Time & Date Setup

#### 3.4.1. Set Time

You can set the current time using the four tabs at the top of the screen. You also have the option of using a 24-hour clock by pressing the tab at the bottom of the screen.

#### 3.4.2. Set Date

You can set the date using the three tabs at the top of the screen.

### 3.5. Location Setup

The iGrow 800™ has an internal astronomical clock. By knowing the actual coordinates, sunrise and sunset times can be precisely calculated. Go above to find coordinates for your precise location. If a negative longitude is given you are west, and if a negative latitude is given you are in the southern hemisphere.

#### 3.5.1. Edit Latitude

To edit, press the appropriate tab at the bottom of the screen.

#### 3.5.2. Edit Longitude



To edit, press the appropriate tab at the bottom of the screen.

### 3.6. Energy Cost

3.6.1. Electricity

3.6.2. Oil

3.6.3. Gas

3.6.4. Water

3.6.5. Other

### 3.7. Communication Setup

3.7.1. Weather Station Setup

3.7.2. IP Address Setup

3.7.2.1. IP Address

3.7.2.2. Subnet Mask

3.7.2.3. Gateway Address

3.7.2.4. MAC Address

### 3.8. Measurement Units

3.8.1. Temp Units

The lower left-hand tab on the Measure Units Setup screen is used to toggle between the Fahrenheit or Celsius units for temperature. Every temperature reading displayed will be based on the units you select.

3.8.2. Speed Units

The second tab at the bottom of the screen is used to toggle between Mph (Miles per hour) and kmph (kilometers per hour).

3.8.3. Light Units

The third tab from the bottom left is used to select between Watts/meter squared and Kilolux (Klux) for light measurements.

### 3.9. Advanced

3.9.1. Unit Info

This tab provides important information regarding your iGrow unit. It includes the model type, the version number, and the serial number.

3.9.2. Humidity Settings

This screen will specify some important parameters for your humidity control. With this screen you have the option of cycling the humidification and dehumidification stages. For example, suppose your zones humidity exceeds the humidity threshold. Without the cycling option, your system will remain in the dehumidification stage until the humidity falls below the dehumidification threshold by at least 2% RH. In some cases, it may be impossible to get below your humidity threshold. For these circumstances and for other cases, it would be helpful to cycle in and out of the humidity control override. This screen gives you the capability to do so.

The options are:

1. Set the override ON duration in minutes and seconds.
2. Set the override OFF duration in minutes and seconds.
3. Set a low temperature threshold.

The low temperature threshold is the outside temperature below which the dehumidification stage will revert to its Cold dehumidification state. For example, you may want to dehumidify but if it is very cold outside, you may want to turn on the heat instead of opening a vent and turning on a fan.

This humidity settings option can be useful in other applications even if you do not have a humidity sensor. For example, you may want to do misting control with a particular output, You can set up a "software" humidity sensor, a humidity time window and threshold so that the cycling will take place during your selected time period.

### 3.9.3. Stage Delay

This time setting in seconds is the shortest time permitted for switching between temperature stages. A typical value here would be 60 to 120 seconds. This parameter is useful in minimizing the cycling of your equipment.

## 4. Stages

### 4.1. Temp Stages

#### 4.1.1. "All Equipment Stages"

This selection gives you a table with each piece of equipment in the left column and each stage of heating and cooling across the top. It gives a quick overview of how you have programmed each piece of equipment. It also gives you the option of programming in a single location any or all the equipment for temperature control.

### 4.2. Humidity Stages

#### 4.2.1. "All Equipment Stages"

This selection gives you a table with each piece of equipment in the left column and each humidity stage across the top. It gives a quick overview of how you have programmed each piece of equipment. It also gives you the option of programming in a single location any or all the equipment for humidity control.

##### 4.2.1.1. Humidify

When the zones humidity goes below the low humidity setpoint, this engages the humidity or humidification stage.

Equipment programmed at the controller can be activated or deactivated, as desired, when this stage is triggered. Another option for each piece of equipment is N/A, which means no particular action is taken with that equipment in the humidify stage.

##### 4.2.1.2. De-Humidify

When the zones humidity goes above the high humidity setpoint, this engages the dehumidification stage.

Equipment programmed at the controller can be activated or deactivated, as desired, when this stage is triggered. Another option for each piece of equipment is N/A, which means no particular action is taken with that equipment in the humidify stage.

##### 4.2.1.3. De-Humidify (Cold)

When the zones humidity goes above the high humidity setpoint and the outdoor temperature goes below xx deg, the "Cold De-humidification" stage is engaged. Equipment programmed at the controller can be activated or de-activated, as desired, when this stage is triggered. Another option for each piece of equipment is N/A, which means no particular action is taken with that equipment in this stage.

# Resetting the Controller

Hard Reset- If you need to perform a reset, open the front door, and locate the RED push button switch on the right-hand side. Pressing this briefly will reset the controller. This is a safe operation and will not cause you to lose any programming or configurations.

Factory Default Reset- if ever wanted, or is necessary, you can reset the iGrow 100 Series™ to its factory default settings. To do this, unplug the controller, remove the battery for 30 seconds, then reinsert the battery back into the holder. Apply power. After doing so, the controller will say "iGrow 100 Series™ Restoring Default Configurations..." It is suggested that you use a USB stick to save your configurations before making a factory default reset. Then, you can use it to quickly restore all your settings.

WARNING: This process will erase all your programmed settings. This cannot be undone.



iGrow 100 Series™

Link4 Corporation

175 E Freedom Ave

Anaheim, CA 92801

(866) 755-5465

Copyright © 2021 Link4 Corp. All rights reserved