

SPIDER  FARMER

LED GROW LIGHT & GROW TENT

# PRODUCT CATALOG

SF LED GROW LIGHT

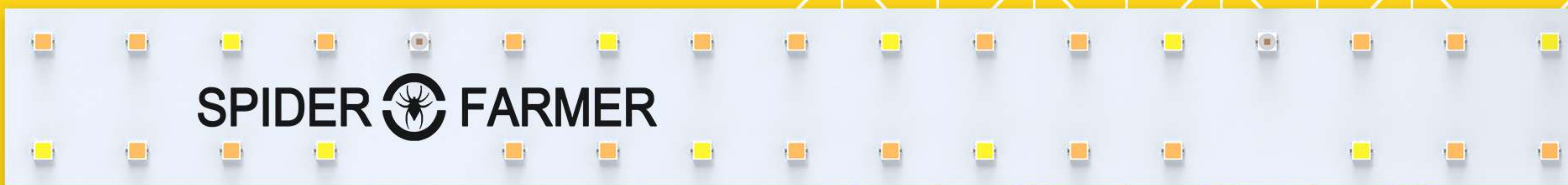

GROW TENT

[www.spider-farmer.com](http://www.spider-farmer.com)



# SPIDER FARMER CATALOG

Company introduction.....02

Led Grow lights.....03

- SE1000W/G1000W
- SE7000/5000/3000
- SF7000/4000/2000/1000
- SF600/SF300

Grow Tent.....10

- 150 X 150 X200 CM ( 5'X 5'X 6.6')
- 140 X 70 X200 CM ( 4.5'X 2'X 6.6')
- 120 X 120 X200 CM ( 4'X 4'X 6.6')
- 90 X 90 X180 CM ( 3'X 3'X 6')
- 70X70X160 CM(2.3'X2.3'X5')

Grow Kits.....11

- SF1000 full grow kits
- SF2000 full grow kits
- SF Grow Kits-4
- SF Grow Kits-6

Accessories.....12

- Spider Farmer Seedling Heat
- Grow bags
- 4/6 inch knob fan kits
- 4/6 inch intelligent fan kits
- Spider Farmer controller

Warranty.....15

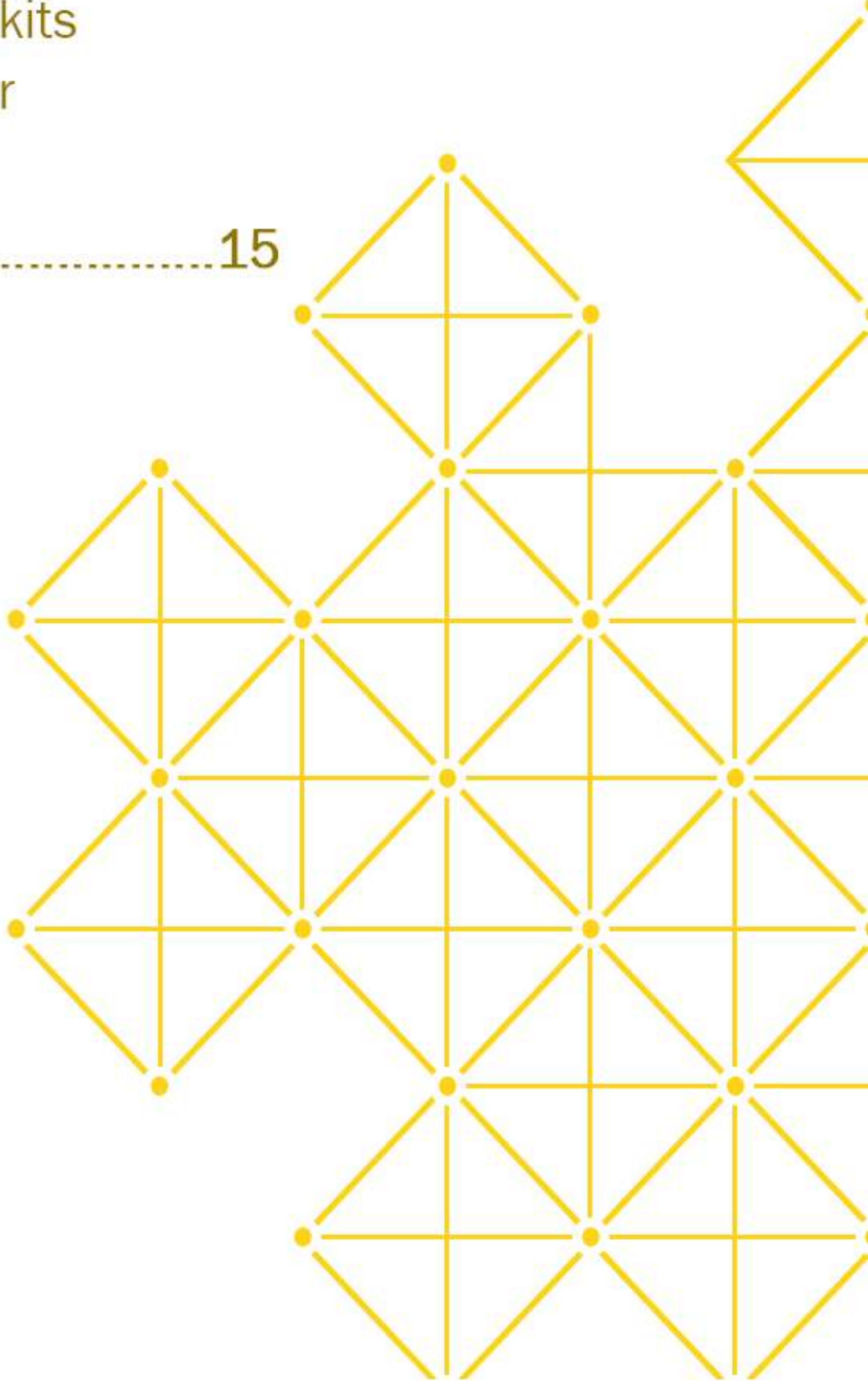
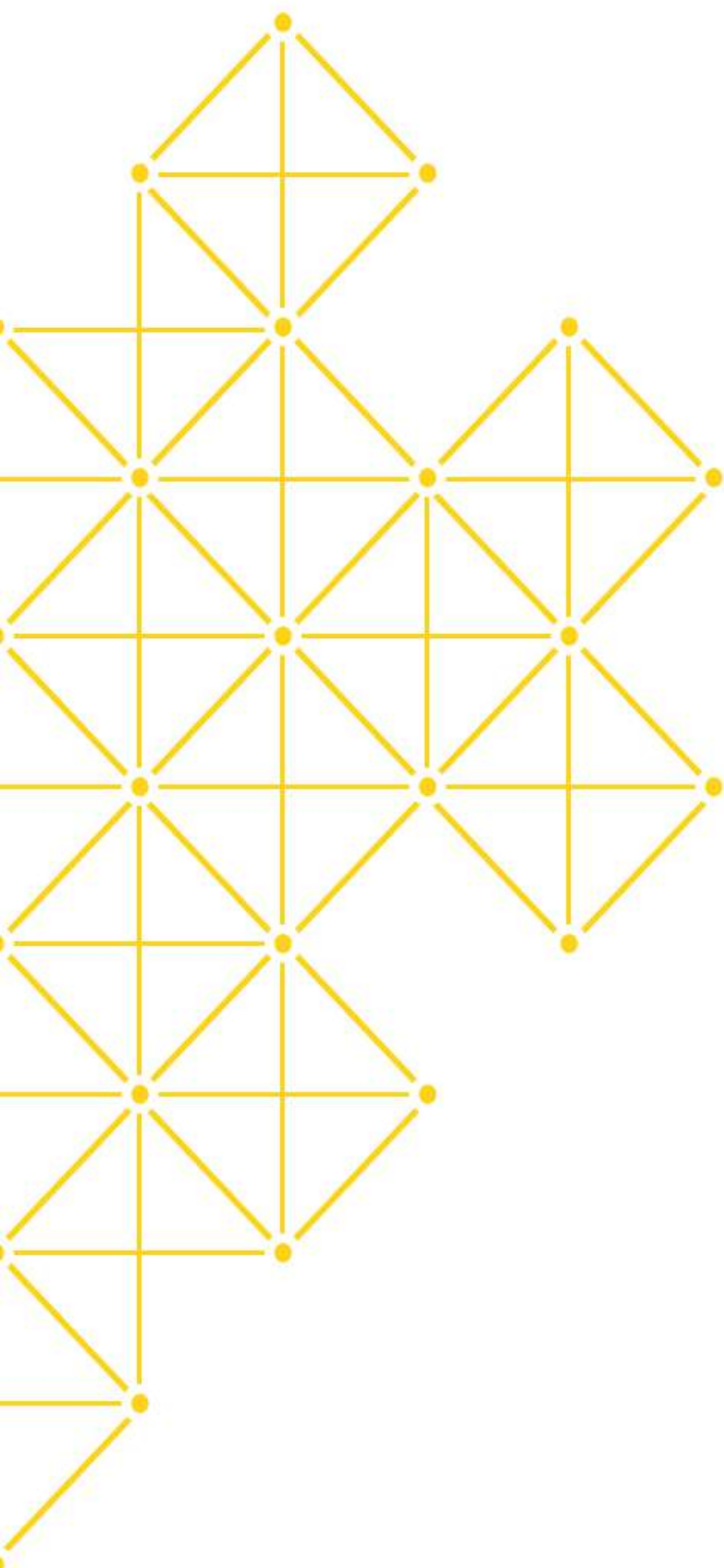



# COMPANY INTRODUCTION

Created in 2015, Spider Farmer will always be fresh in providing the most suitable LED grow lights with the high quality as well as the affordable prices. There exists inexhaustible innovation ability in the Spider Farmer Team, the true action to manufacture the latest LED grow lights is a strong proof for this point. Most importantly, customer orientation is the highest objective of Spider Farmer, we are keeping chasing this goal since our establishment. A complete and considerable sales and after sales service system is formed, and still on its way to perfect. Therefore, oversea warehouses are the other bright point for improving the purchasing experience of our customers. We will always keep the customer opinions in mind, and make the grow become simple.

Happy grow  
Spider Farmer Team



RoHS

Samsung LED In-branding  
Official Partner





# SE 1000W/G1000W



## ● FULL SPECTRUM

SE 1000W

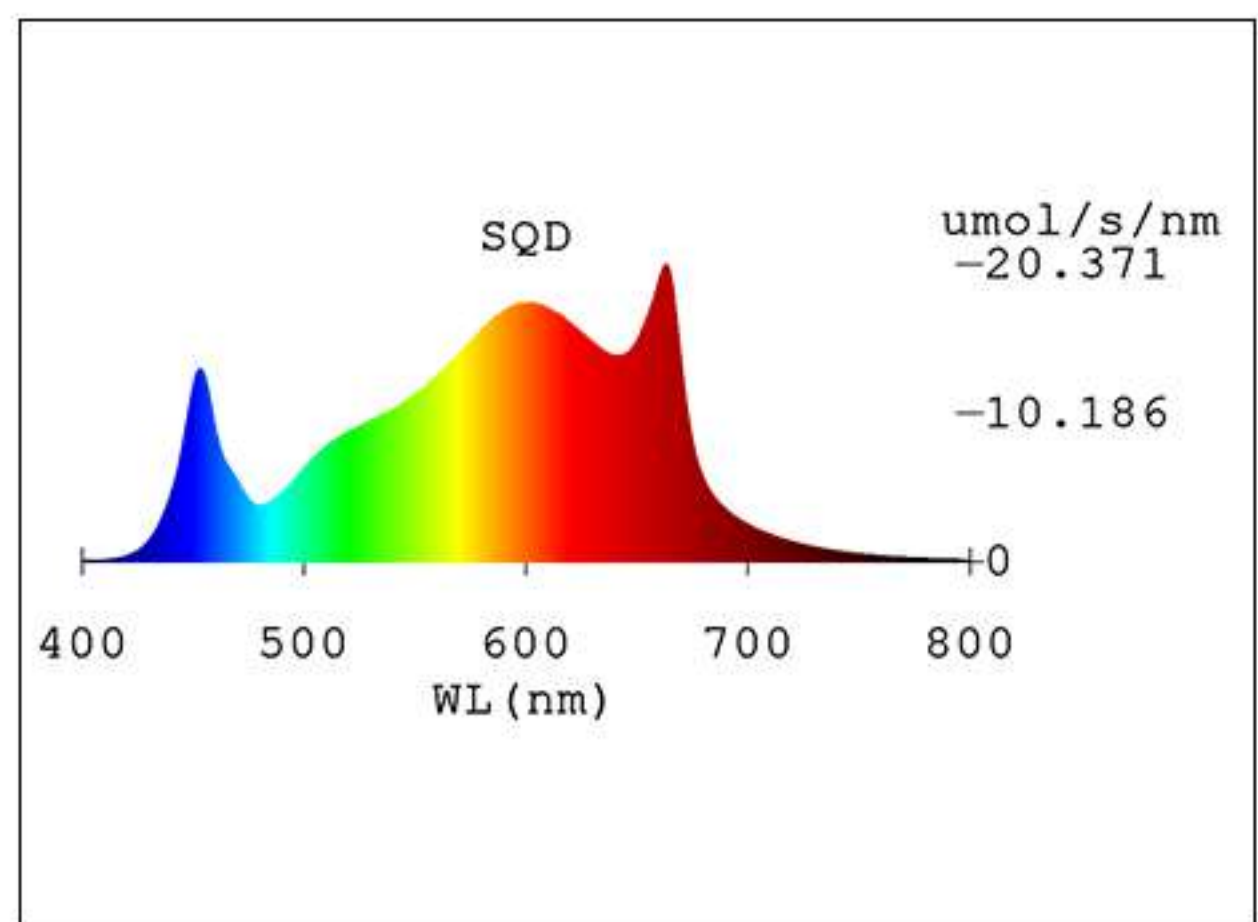

G1000W

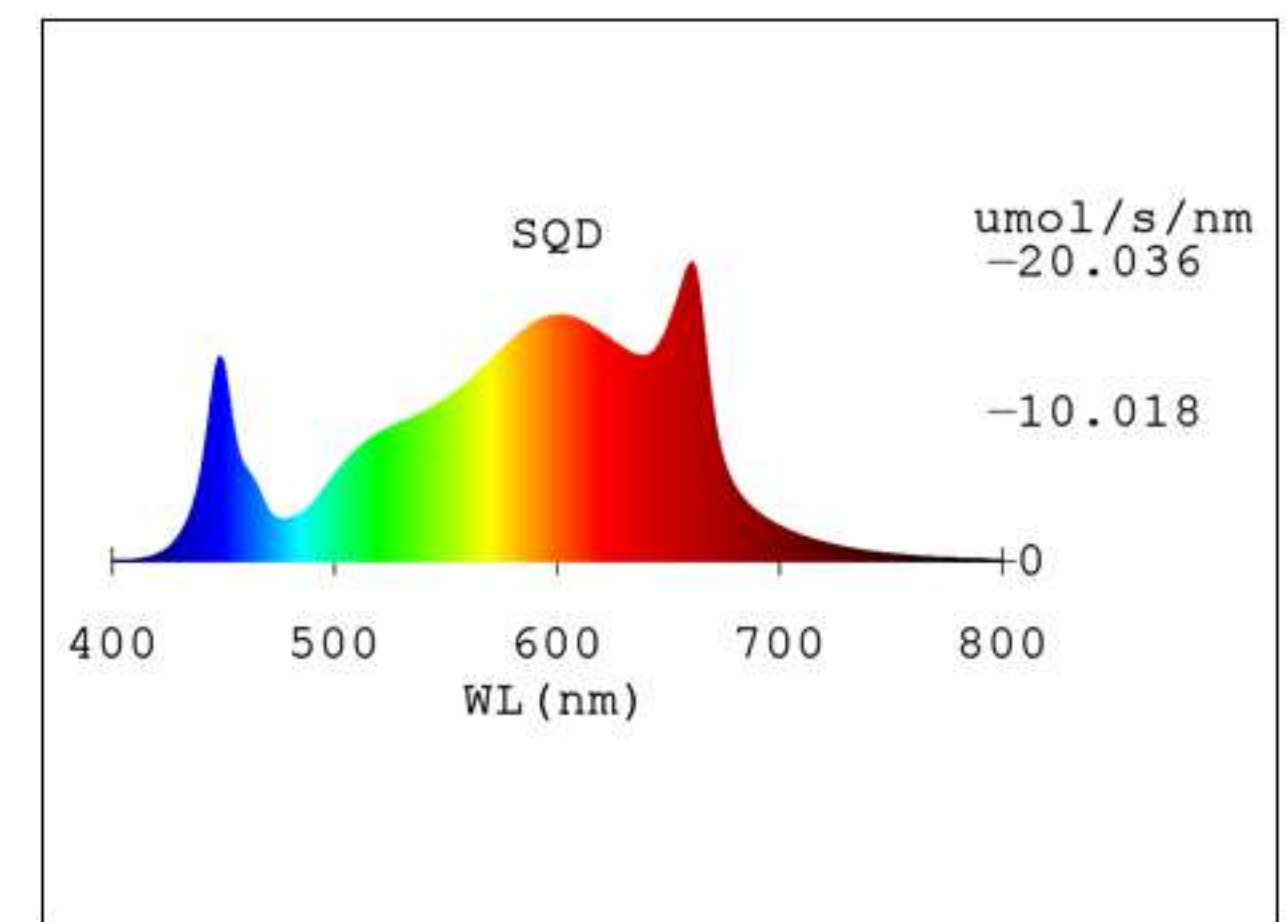

## ● SPECIFICATIONS

Model	Power Draw	Par Value	Amps	LED	Footprint	Energy Efficacy
SE1000W	1000W @AC200-277V	2955umol/S @220V	4.678A @AC220V	Samsung LM301B 3710pcs	Commercial: 4x4 FT Personal Coverage: 5x5 FT	2.9umol/J
G1000W	1000W @AC200-277V	2772umol/S @220V	4.558A @AC220V	Bridgelux 4910pcs	Commercial: 4x4 FT Personal Coverage: 5x5 FT	2.9umol/J

## ● PPF(12')

SE 1000W

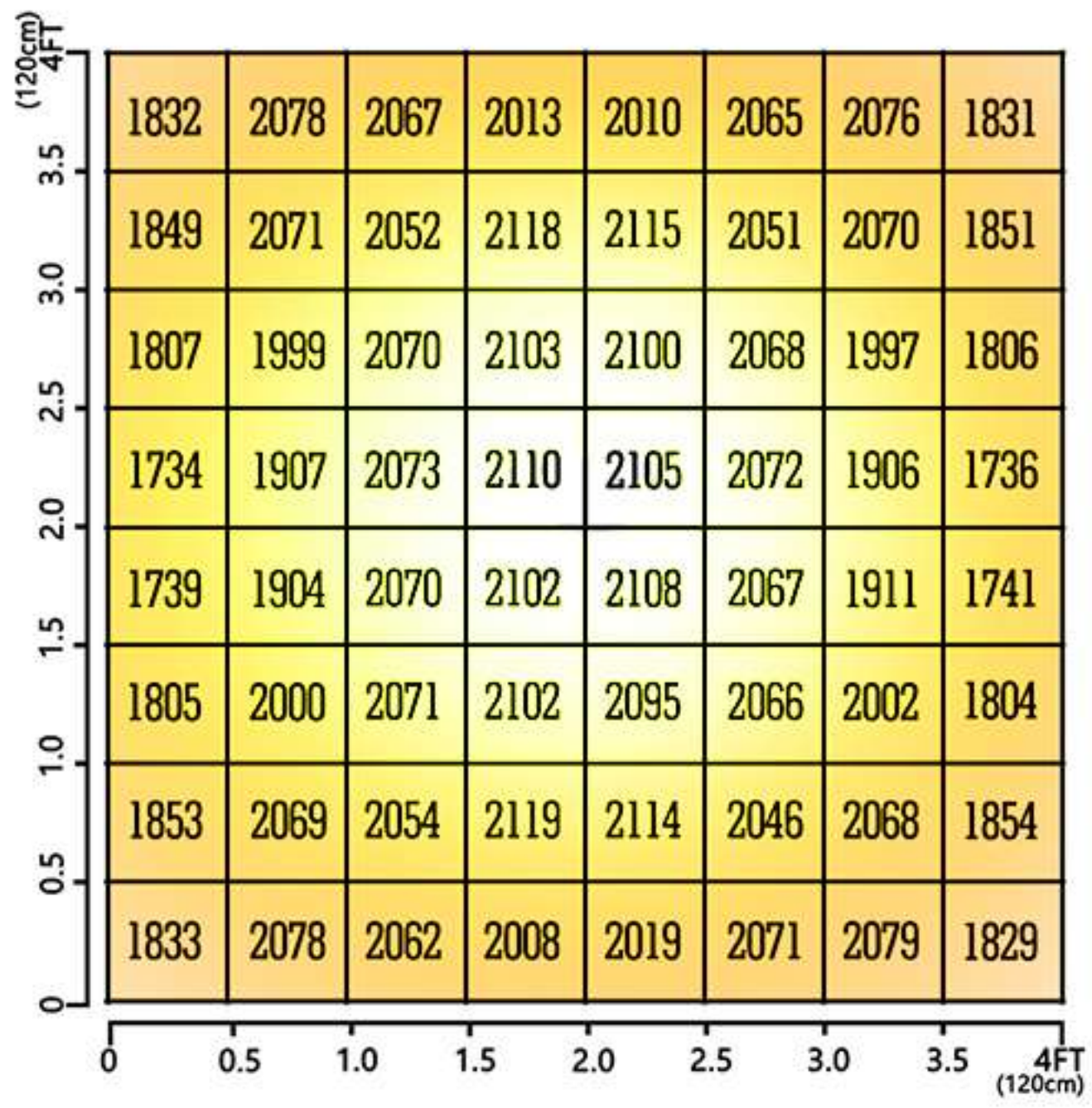

G1000W

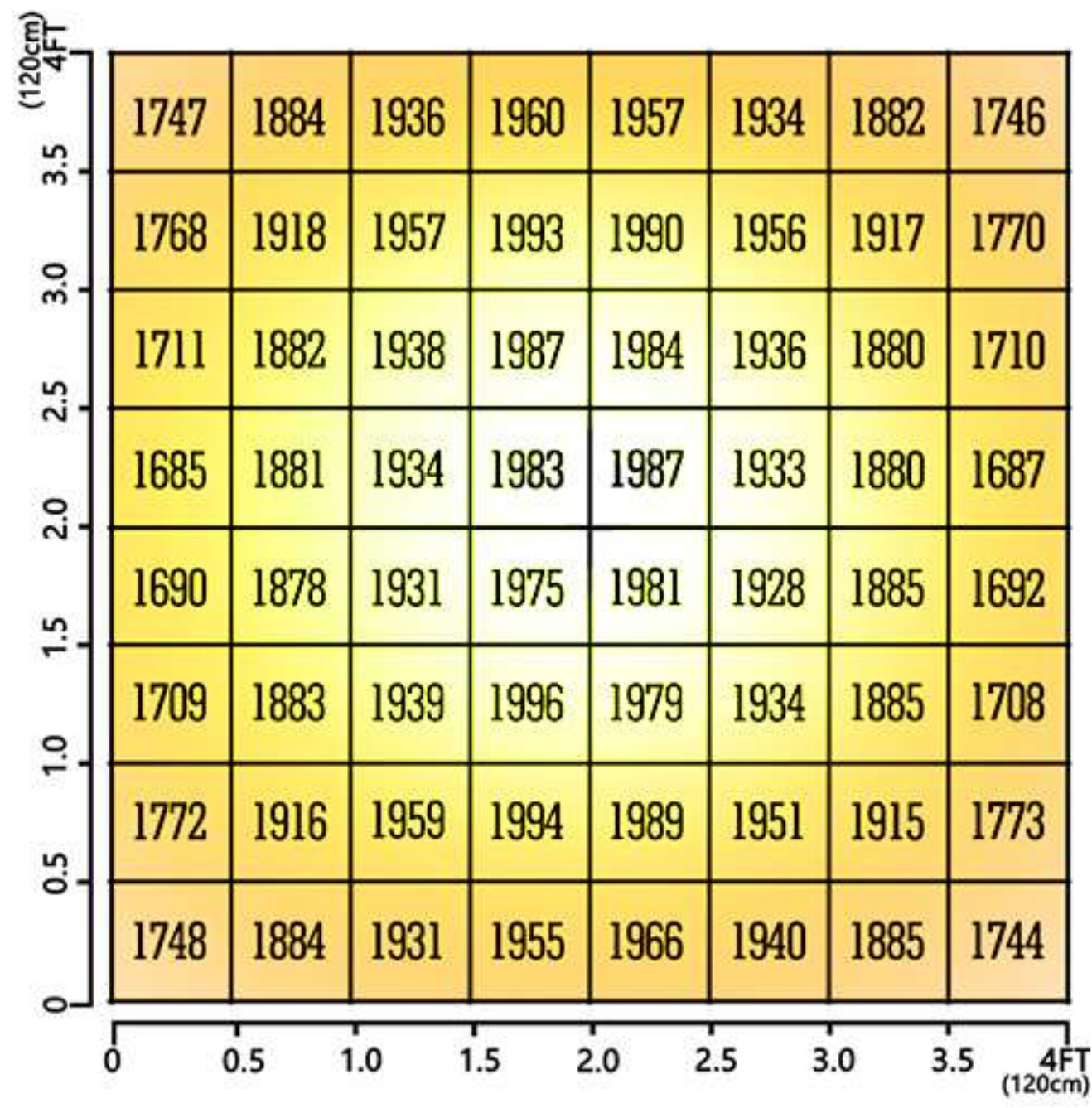



● Certification



RoHS

Features:

- 1) 2.9 umol/J High Efficiency.
- 2) Uniform PPFd: Average par value up to 1800. Uniform photon distribution makes high yields on edge area.
- 3) Optimized Full Spectrum: Fits for all stages. More red light for flower stage, increasing the cannabis yields by 20%-50%.
- 4) Using under CO2 system.
- 5) Daisy Chain: Support up to 50 lights.

● FUNCTION

- ▶ Perfect for commercial growing
- ▶ Main Light Dimming Control
- ▶ Support up to 30 lights





# SE 7000/5000/3000



## ● FULL SPECTRUM

SE 5000

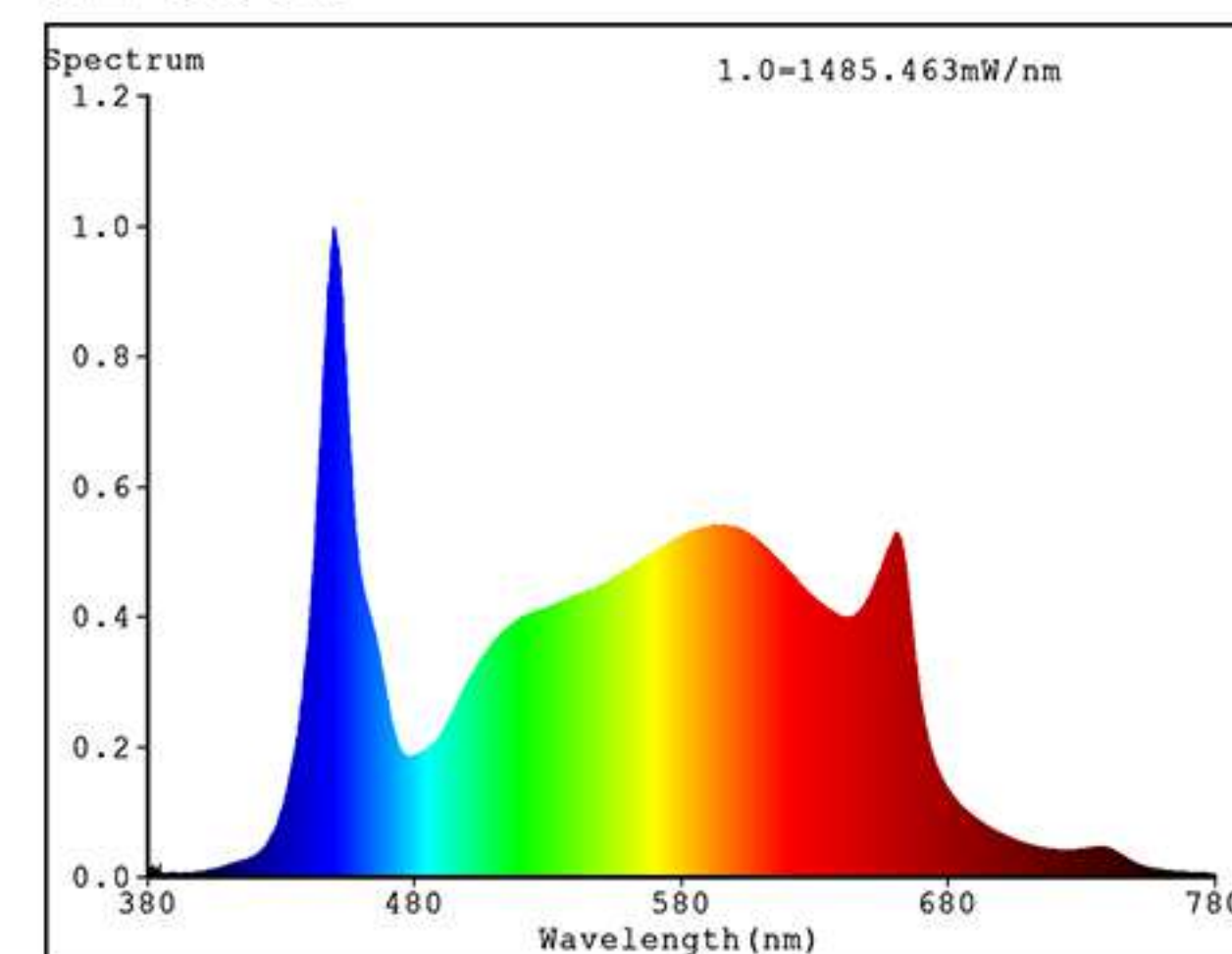

SE 7000

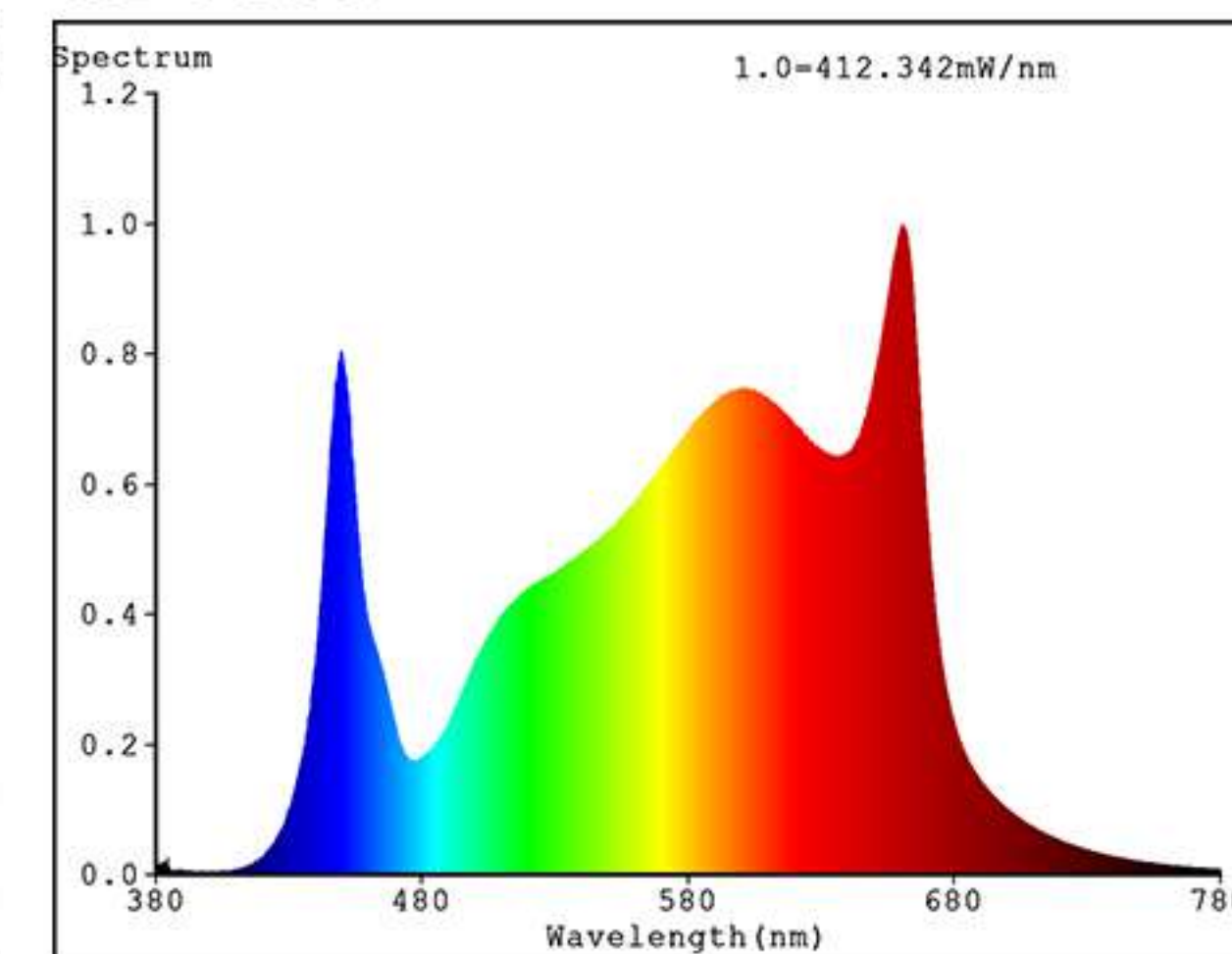

## ● SPECIFICATIONS

Model	Power Draw	Par Value	Amps	LED	Footprint	Energy Efficacy
SE7000	650W±5% @AC100-277V	1780.45 umol/S	5.382A@AC120V 2.661A@AC240V 2.312A@AC277V	LM301B 2688pcs	Commercial: 4x4 FT Personal Coverage: 5x5 FT	2.8umol/J
SE5000	480W±5% @AC100-277V	1317.4 umol/S	3.987A@AC120V 2.0009A@AC240V 1.752A@AC277V	LM301B 1680pcs	Commercial: 3x3 FT Personal Coverage: 4x4 FT	2.75umol/J
SE3000	300W±5% @AC100-277V	822.82 umol/S	2.471A@AC220V 1.230A@AC220V 1.077A@AC220V	LM301B 896pcs	Commercial: 2x2 FT Personal Coverage: 3x3 FT	2.75umol/J

## ● PPF(12')

SE 5000

320	546	676	730	722	681	556	330
425	813	1029	1188	1171	1025	813	420
516	905	1215	1335	1330	1211	902	516
488	827	1105	1199	1192	1100	837	478
468	825	1109	1195	1200	1106	830	466
512	902	1210	1325	1338	1216	905	515
435	810	1030	1180	1173	1029	808	430
330	565	680	735	722	685	560	326

SE 7000

928	1190	1100	1130	1150	1179	1165	922
983	1170	1153	1186	1200	1160	1180	979
846	1047	1023	1073	1090	1077	1060	845
850	1006	1030	1040	1047	1020	1010	852
856	1002	1020	1039	1037	1030	1008	851
840	1048	1012	1089	1082	1018	1058	845
980	1178	1157	1190	1198	1150	1172	985
920	1170	1100	1130	1138	1120	1170	930



## ● TOP FEATURES



**SAMSUNG**  
LM301

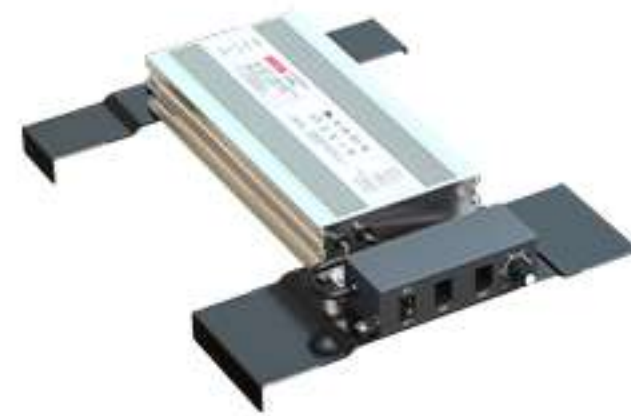

**REMOVABLE**  
Driver



**DIMMING**  
Daisy Chain

## Features:

- 1) Lights distribution more uniform, par value on each point can up to 1000.
- 2) Can make lights closer to plants, flowering hang height can at 6"-8".
- 3) Higher efficacy and higher yielding up to 3.75-4.5 lb per light.
- 4) SE7000 up to 2688pcs Samsung chips to achieve outstanding efficiency, up to 2.8 umol/j.
- 5) Lower consumption on each diodes, longer lifespan and save 50% money on electricity bill.
- 6) With dim knob and daisy chain, Plug-in light bar, easy to install.

## ● FUNCTION



Dimming Knob



Light Intensity



Multi-light connection  
dimming operation

## DIMMING DAISY CHAIN

- Up to 30 lights connected
- Multiple models daisy chain





# SF 7000/4000/2000/1000

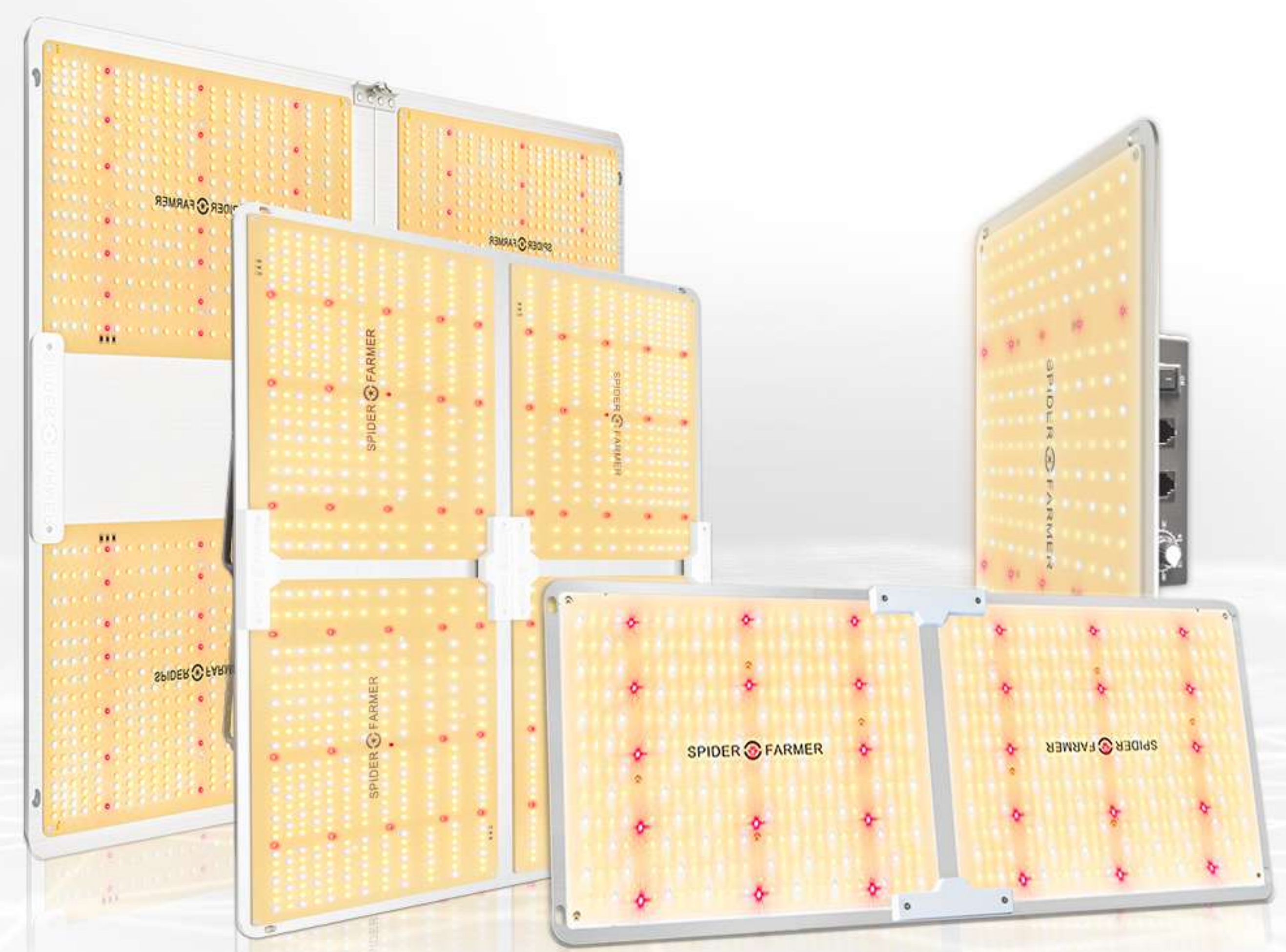

## ● SPECIFICATIONS

Model	Power Draw	Par Value	Amps	LED	Footprint	Energy Efficacy
SF7000	650W±5% @AC100-277V	1786 umol/S	5.40A@AC120V 2.65A@AC240V 2.30A@AC277V	LM301 1716 pcs	Commercial: 5x5 FT Personal: 6x6 FT	2.8umol/J
SF4000	450W±5% @AC100-277V	1156.50 umol/S	3.70A@AC120V 1.90A@AC240V 1.67A@AC277V	LM301 1212 pcs	Commercial: 4x4 FT Personal: 5x5 FT	2.7umol/J
SF2000	200W±5% @AC100-277V	514.2 umol/S	1.64A@AC120V 0.82A@AC240V 0.75A@AC277V	LM301 506 pcs	Veg: 3x4 FT Flower: 2x4 FT	2.7umol/J
SF1000	100W±5% @AC100-277V	230 umol/S	0.784A@AC120V 0.398A@AC240V 0.352A@AC277V	LM301 218 pcs	Veg: 3x3 FT Flower: 2x2 FT	2.5umol/J

## ● FULL SPECTRUM & PPFD(12")

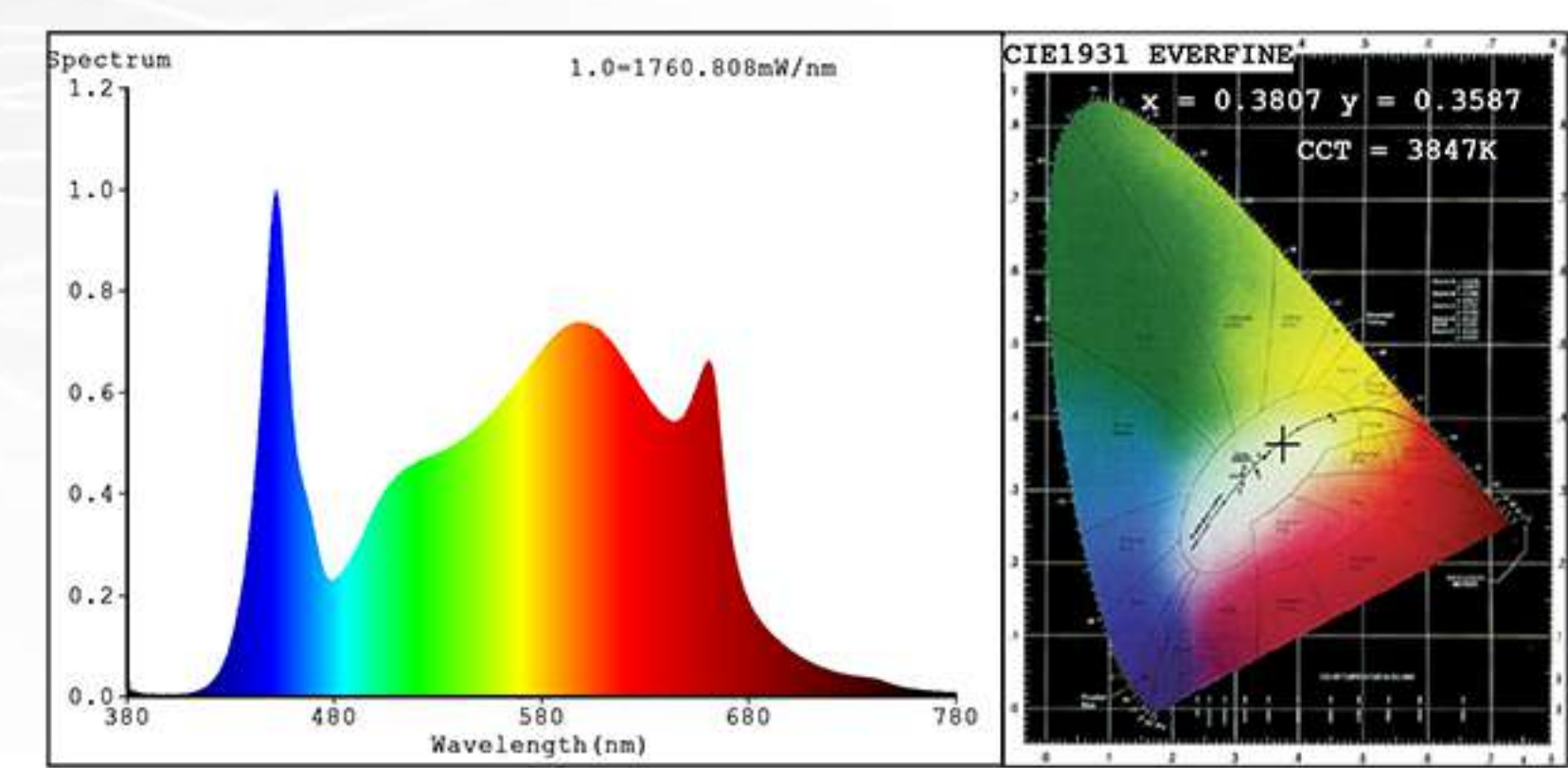

### SF 4000

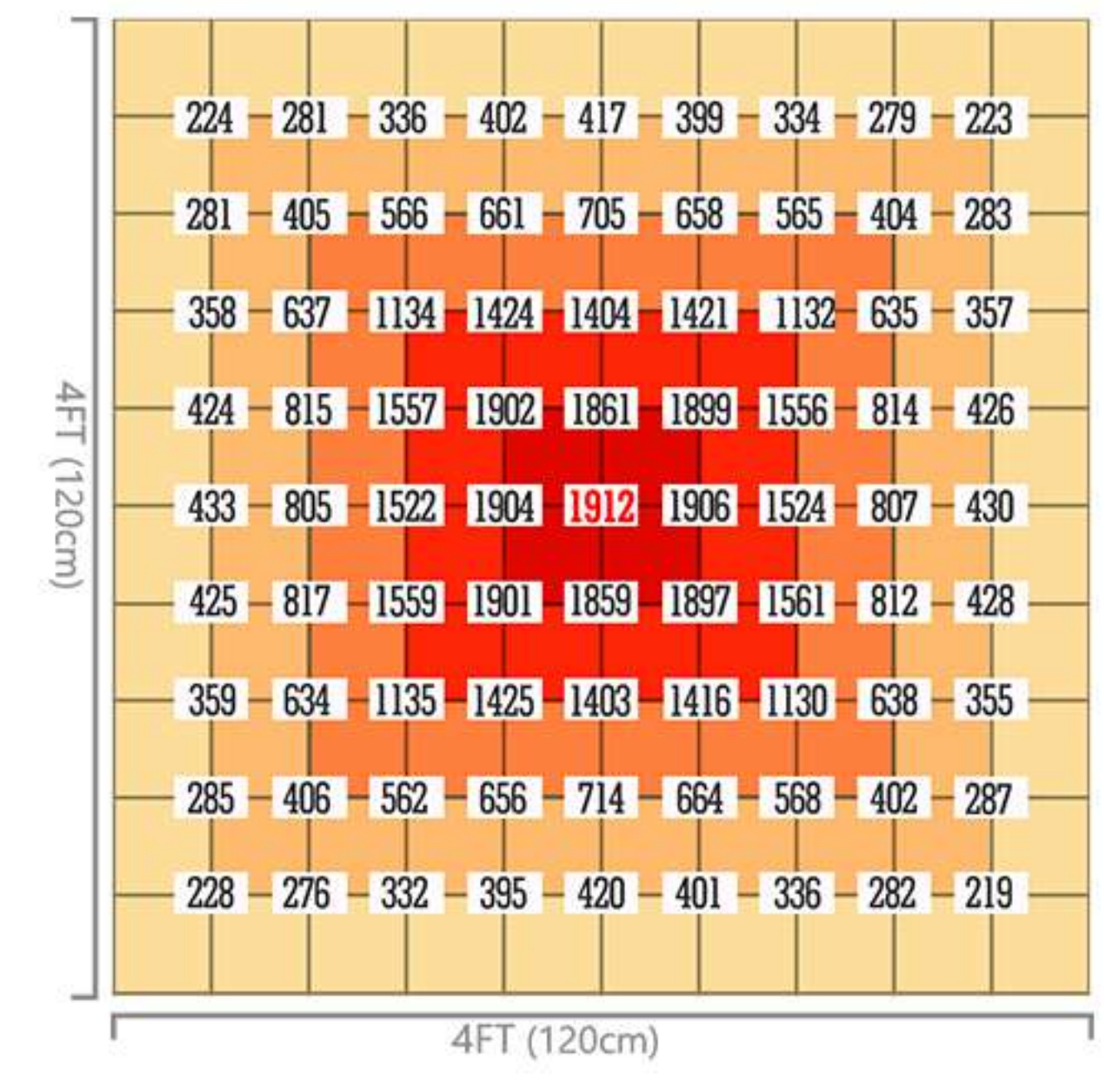



# ● TOP FEATURES



SAMSUNG LM301



Meanwell Driver  
SF1000, SF2000



SF2000, SF4000 ACQUIRED



SF1000, SF2000, SF4000 ACQUIRED

- 1) Lower Running Cost & Higher-Quality Yields
- 2) Customized Dimming Design
- 3) Ideal For All Growth Stages
- 4) Well Made & Solid Construction
- 5) Value For The Money

# ● FUNCTION



Light on-off switch



Easy control light dimming screw



Multi-light connection dimming operation

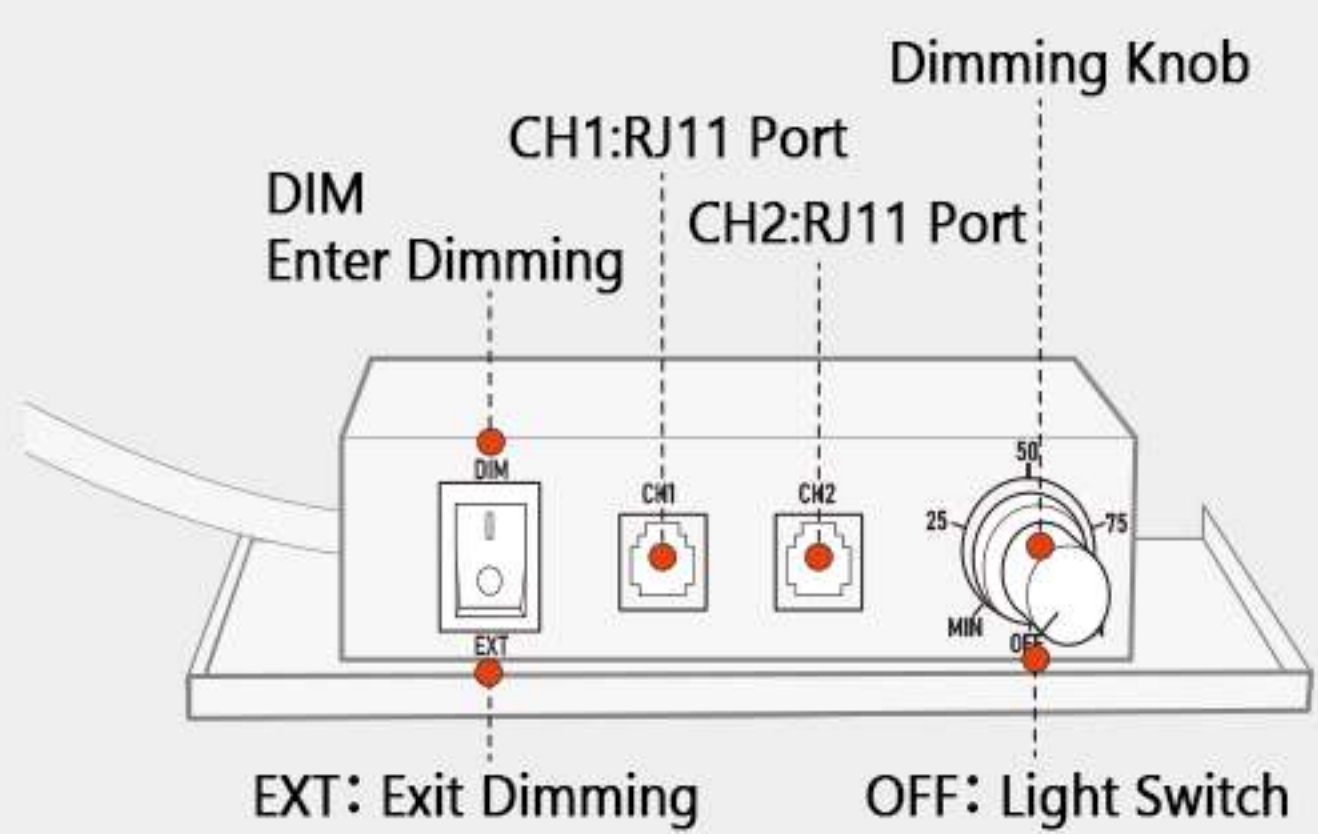

SF1000 & SF2000 & SF4000 can be connected to each other for dimming





# SF 600/300

## ● SPECIFICATIONS

Model	Power Draw	Amps	Frequency	Footprint	Par value	LED	Light Size
SF600	73.79W±5%@AC120V 74.75W±5%@AC240V	0.6235A@AC120V 0.6310A@AC240V	50-60HZ	4x2 FT	166.81 umol/S	384pcs	1000*150*35.4MM
SF300	32.77W±5%@AC120V 33.47W±5%@AC240V	0.4823A@AC120V 0.2953A@AC240V	50-60HZ	2.5x2 FT	74.92 umol/S	192pcs	600*150*35.4MM

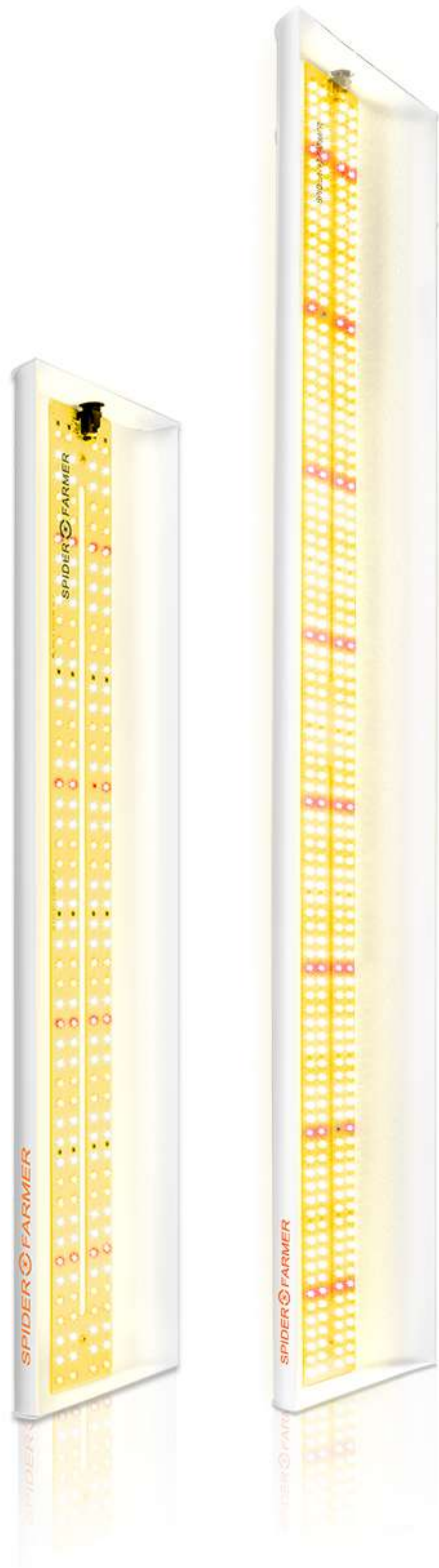



# TENT



## ● SPECIFICATIONS

SIZE	RECOMMENDED LIGHT	WEIGHT
150x150x200CM(5'X5'X6.6')	SF7000,SF4000,SE7000	14.2 KG
140x70x200CM(4.5'X2'X6.6')	SF2000,SF600	10.5 KG
120x120x200CM(4'X4'X6.6')	SF4000,SE5000,SE700	12.5 KG
90x90x190CM(3'X3'X4.6')	SF2000,SE3000,SE5000	9 KG
70x70x160CM(2.3'X2.3'X5')	SF1000,SE3000,SF300	6.8 KG

## ● FUNCTION



Cooling air tubes



Air extrzction opening



Anti-aging joints

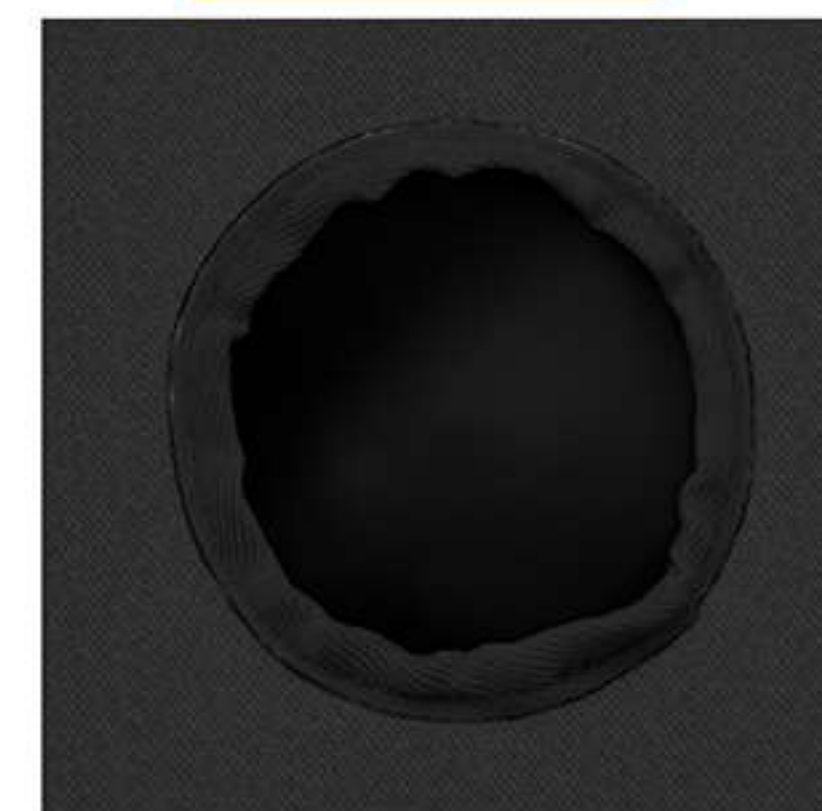

Power cord ports

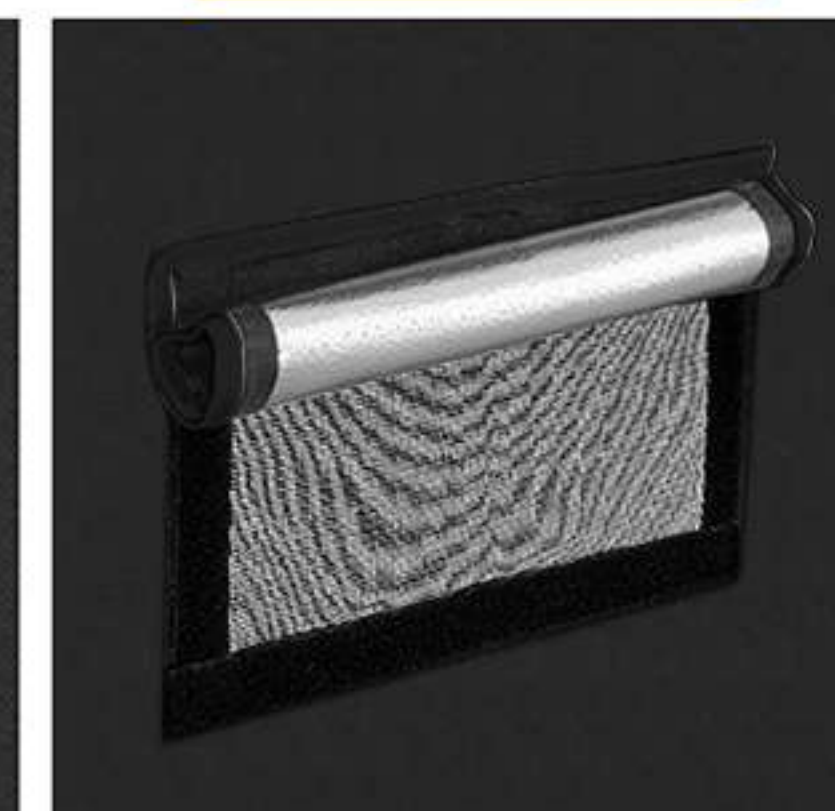

Ventilation windows

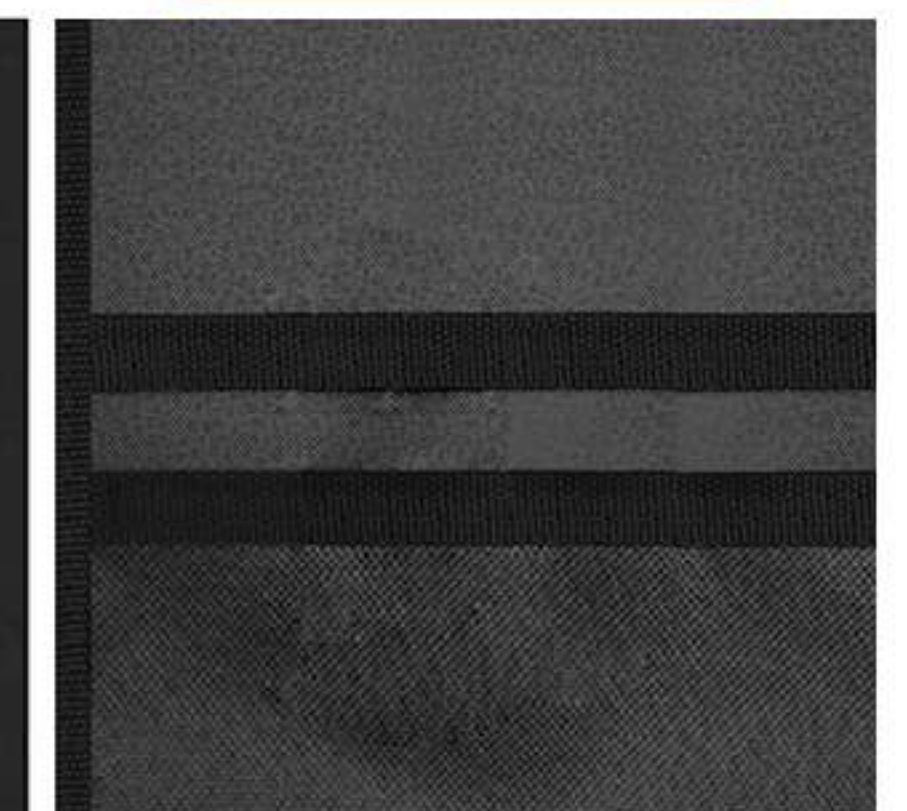

Ventilation windows



# GROW KITS

## ● SF1000 FULL GROW KITS



## ● SF2000 FULL GROW KITS



- 1 × SF-1000 Full Spectrum LED Grow Light
- 1 × 27" X 27" X 62" Grow Tent
- 1 × 4" Inline Duct Fan
- 1 × 4" Carbon Filter
- 1 × Flex Air Aluminum Ducting
- 2 × Ducting Clips
- 1 × Thermometer and Hygrometer
- 1 × Timer
- 4 × 5 Gallon Grow Bags
- 2 × Adjustable Rope Clip Hanger

- 1 × SF2000 Full Spectrum LED Grow Light
- 1 × 48" X 24" X 72" Grow Tent
- 1 × 4" Inline Duct Fan
- 1 × 4" Carbon Filter
- 1 × Flex Air Aluminum Ducting
- 1 × Thermometer and Hygrometer
- 1 × Timer
- 4 × 5 Gallon Grow Bags
- 2 × Adjustable Rope Clip Hanger

## Spider Farmer 4/6 Inch Intelligent Inline Fan Carbon Filter Combo Ventilation



- 4/6 Inch Fan With Speed Setter
- YOYO
- 10M Flue Pipe
- 4/6 Inch Carbon Filter
- Timer
- Thermo-Hygrometer

## ● SPECIFICATIONS

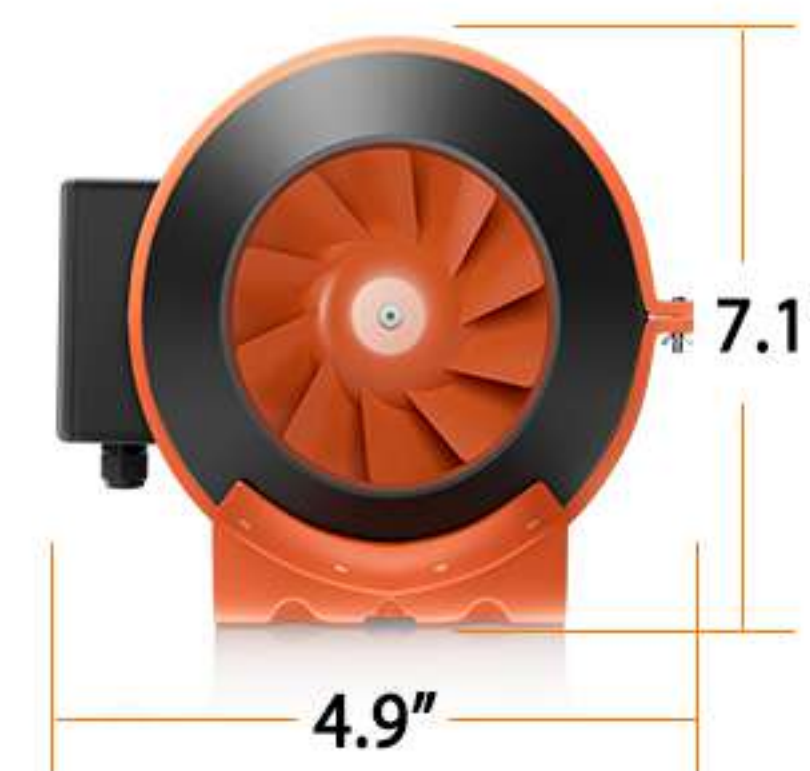

- Model:GDF150-p
- Air Volume:660m<sup>3</sup>/h
- Duct size: 6 INCH
- Power:70Watt
- Capacitance:5uF
- Airflow:395CFM
- Fan speed:2400RPM
- Current:0.58A
- Volt/Hertz: 120V/60HZ
- Noise:<37dB



# ACCESSORIES



Anti-Wrinkle

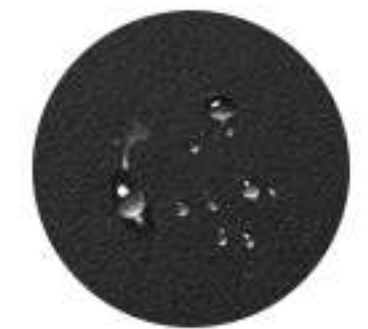

Easy Cleaning



Anti-Scratch

## • SPECIFICATIONS

Size	Power	Product Size	Frequency	Voltage
10"X20.75"	20 Watts	10x20.75inch	60HZ	110-130 VAC
48"X20.75"	105 Watts	48x20.75inch		

## • Grow bags

5-pack 11 gallon



5-pack 5 gallon

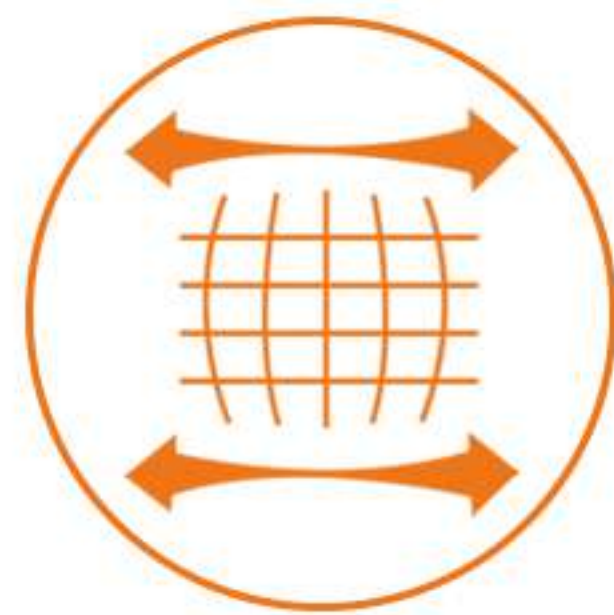

Durable



Breathable



Environment Friendly



# FAN KITS

- 4/6 inch knob fan kits



- 4/6 inch speed controller fan with external knob
- 4/6 inches carbon filter
- 4/6 inch flue pipe 10m long
- 3\*Adjustable clamps

- 4/6 inch intelligent fan kits



- 205/350 CFM Inline Duct Fan with Temperature Humidity Controller
- Carbon Filter
- 32 Feet Ducting Combo Set Ventilation System
- 3\*Adjustable clamps



# SPIDER FARMER CONTROLLER



- One channel dimming, eight sets of timing, touch screen control, real-time monitoring of temperature and humidity data.
- Support PWM/0-10V dimming power supply, and load up to 50 single power and 25 dual power dimming lamps.
- Independent interface for temperature and humidity. Insert temperature and humidity sensor probe when using this function.
- output signal to repeater amplifiers. Be able to connect 20 repeater amplifiers at the same time, and one can be connected to up to 50 single dimming power supply lamps.

**(This machine requires additional purchase)**

## ● Accessories list

### Host

Unified control of power supply with PWM/1-10V functional interface



### Humidity Sensor

Used to collect environmental temperature/humidity data



### Power adapter

Use to support the power of controller



### Dimming signal line

Using grey line to connect other lamps



Using black line to connect Spider Farmer lamps





# REGULAR WARRANTY SERVICE

---

The light can be returned or replaced within 30 days after delivery, in the precondition of non-artificial damage.

## ● LED Grow Lights

Within 30 days: The light can be returned or replaced after delivery, in the precondition of non-artificial damage quality issues.

30 days -3 months: Accessories, repairs and services are provided free of charge. No return or replacement without quality problems.

3 months - 1year: Accessories, repairs and services are provided free of charge.

1 year – 5 years: Free Accessories. The buyer needs to bear the maintenance fee and two shipping costs.

\*Lights shipped from China:Free Accessories.The buyer needs to bear the shipping costs of the accessories.

## ● Inline Fan

2 years warranty: Under normal use, provide free reparation service within warranty period.

[Operating conditions: ambient temperature around 30°C; Relative humidity 15-65%]

## ● Controller And MatKits

2 years warranty: Under normal use, provide free reparation service within warranty period.

## ● Grow Tent And Grow bags

Please check if the package is intact within 48 hours of receiving the product. There is no return service, including tent and mat bags. If you have any questions, please send related videos or photos of the defective product and photos of all labels on the package to email [service@spider-farmer.com](mailto:service@spider-farmer.com) and we will help you solve the problem as soon as possible.

---

### OFFER SOLUTIONS WITHIN 24 BUSINESS HOURS

---

Warehouse: US/CA/AU/UK/EU/RU

Repairing Center: US/CA/AU/UK/EU

Email: [Info@spider-farmer.com](mailto:Info@spider-farmer.com)

TEL:+1 (840) 977-6768

Wechat: spiderfarmerled