

Nutrient, pH & ORP Dosing System

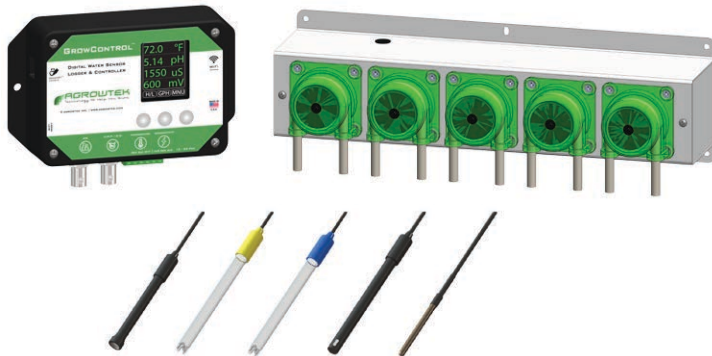

MDX Mini Doser

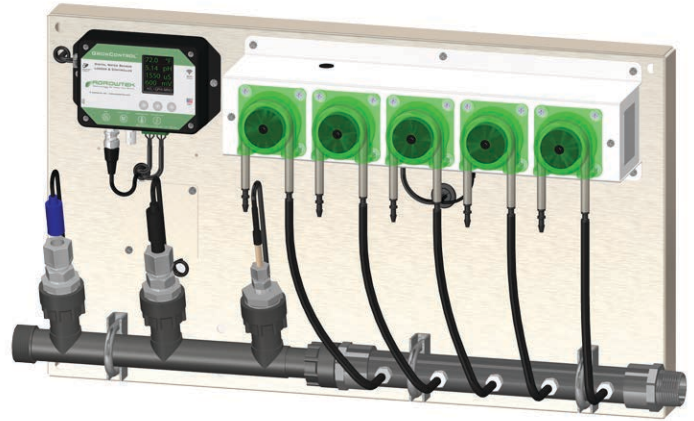

MDXP Panel Mounted Doser

Contents

Overview	2	Units	17
Quick-Start Guide	3	Logging Interval	18
Dimensions	4	COMM Mode	19
Installation Instructions	5	Device Address	19
Mounting the Transmitter	5	Manufacturing Info	19
DIN Rail Mounting Kit	5	Display Back Light Timer	20
Mounting the Dosing Pump	6	Controller Operation, Pumps	21
Connecting Pump Tubing	6	Dosing Pump Control Menu	21
pH & ORP Probe Preparation	7	Priming	21
Operation Instructions	8	Run/Stop	22
Definitions	8	Recipe Menu	22
Dosing Cycles	9	Pump Mode	23
Controller Operation, Sensors	10	Dose Size	24
High / Low History	10	Delay Time	24
Graphing	10	EC Lock-Out	25
Main Menu	11	pH Lock-Out	25
Alarms Menu	11	Target Value	26
Alarms Configuration	11	Deadband	27
Alarm Buzzer	12	Connection to USB AgrowLINK	28
Calibration Menu	12	Firmware Update	28
Temperature Calibration	12	Load a Configuration File	29
pH Calibration	13	Maintenance	30
Conductivity Calibration	14	Probe Cleaning	30
O.R.P. Calibration	14	pH Probe Reconditioning	30
Clear Calibration	15	Technical Information	31
Advanced Calibration	16	Specifications	31
Analog Output Calibration	16	Storage and Disposal	31
Setup Menu	17	Warranty	31
Time / Date	17		

Overview

The MDX dosing system is designed to automatically dose nutrients, pH and ORP buffers into recirculating systems and stock tanks to maintain target levels. The MDX system operates independently of other systems and doses on demand automatically according to target set-points and sensor readings. Each pump can be configured independently to any sensor with unique dose ratios/amounts.

MDX systems require the sensors to be continuously in contact with the water in order to properly manage the dosing pumps. Probe can be located in the reservoir tank, or may be installed inline with a continuously recirculating water flow.

MDX systems are available as pre-fabricated **Dosing Panels** or as basic **Dosing System Kits**.

Dosing Panel



Dosing System Kit



Typical Fertigation Layouts

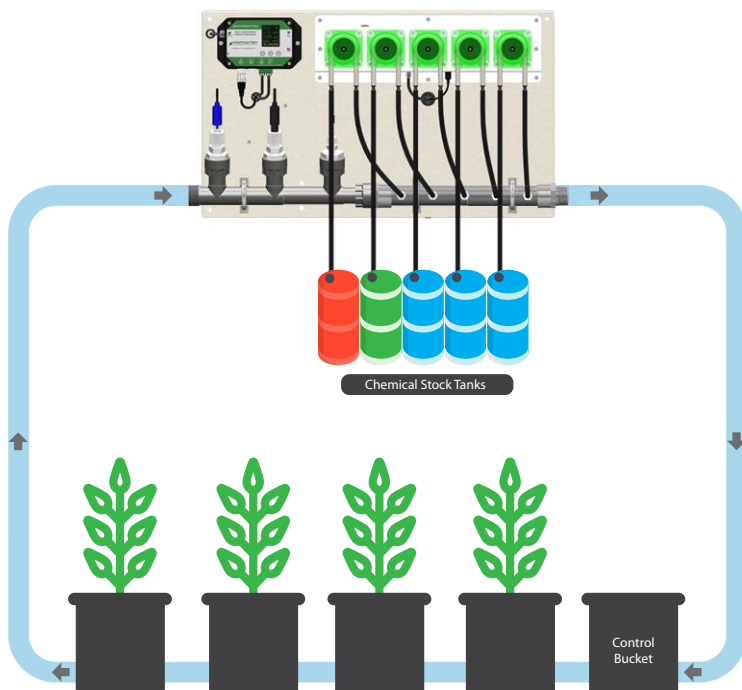

Bucket Systems

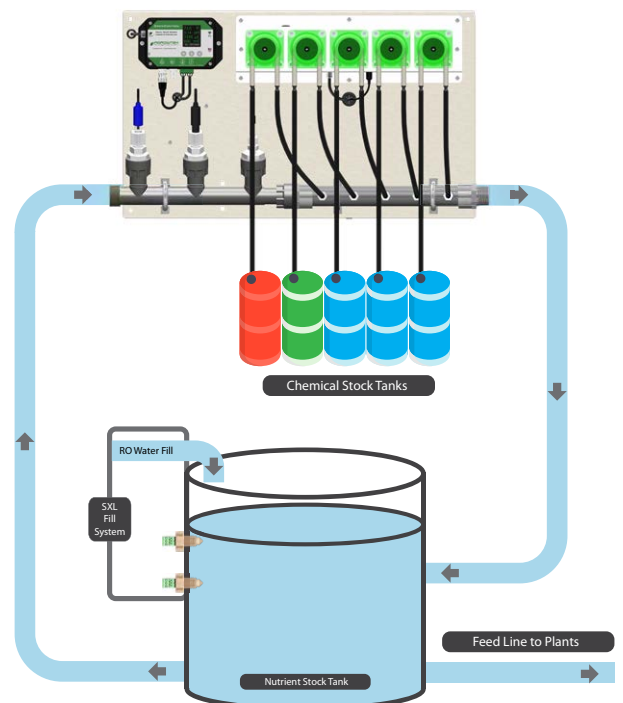

Nutrient Stock Tanks

Quick-Start Guide

1. Connect Sensor Probes

pH and ORP sensors are equipped with “BNC” style connectors; push on and then turn to lock in place.

Temperature and EC probes have a screw terminal block. Make the connections according to the label on the transmitter. The terminal block may be removed for easier wire installation or for service.

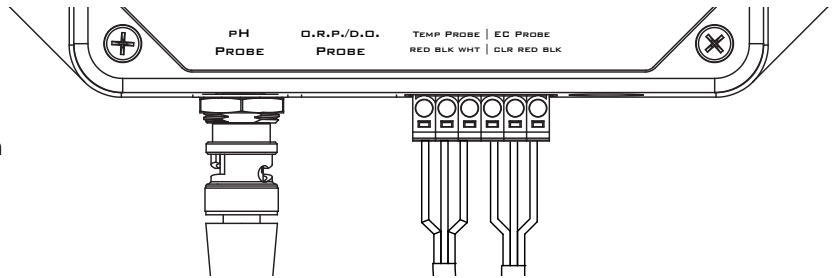

2. Connect Dosing Pump

A direct-link connection between a SXH sensor and ADI pump requires Agrowtek’s cross-over adapter.

⚠ IMPORTANT! ONLY use cross-over adapters provided by Agrowtek.
Incorrect cross-over adapters or cables can cause damage to the equipment.

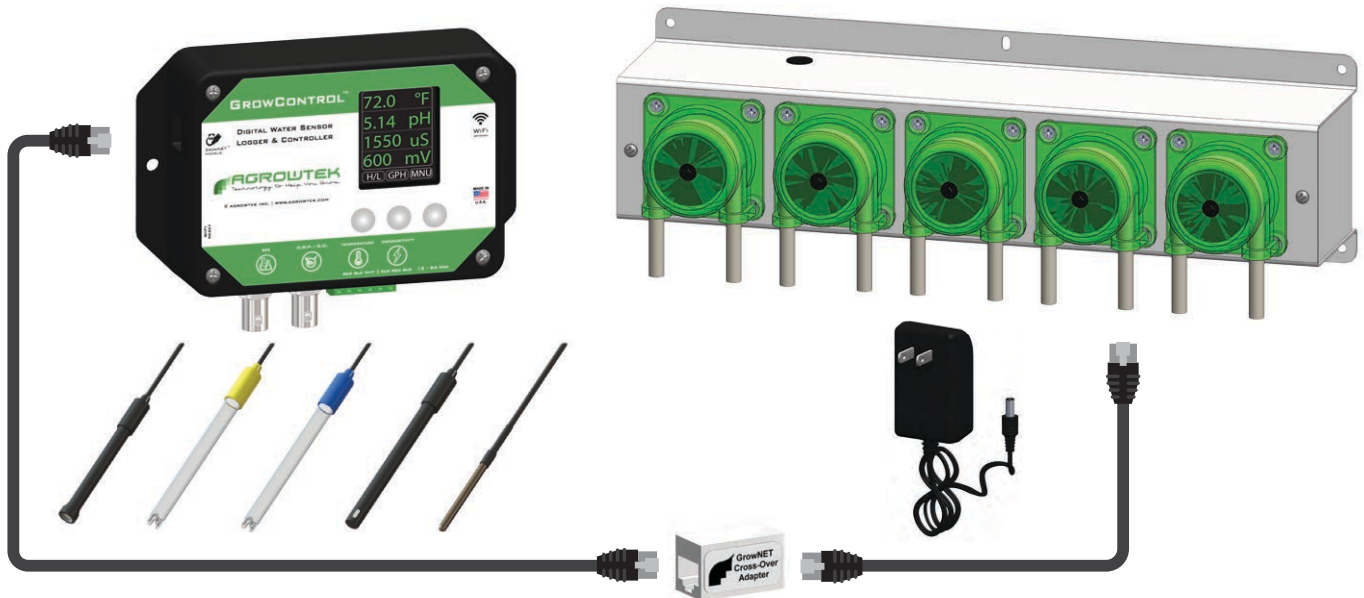

3. Connect Tubing & Configure Pumps

Normal pump rotation is CW. The left tube is inlet (suction) and the right tube is outlet (pressure.)

Connect tubing with barbed fittings as shown. Tubing lengths may be as long as 50ft. Check for proper flow with the prime function.

Use the LCD menus to configure each pump and the the system parameters and then put the pumps into RUN mode to begin auto dosing.

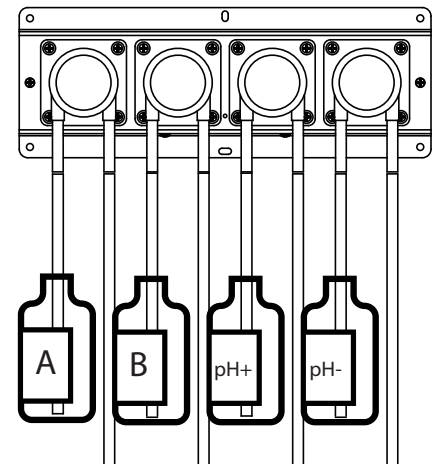

Dimensions

Mounting Holes: dia. 0.201"

n = number of pump heads

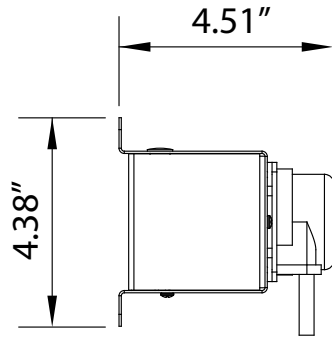
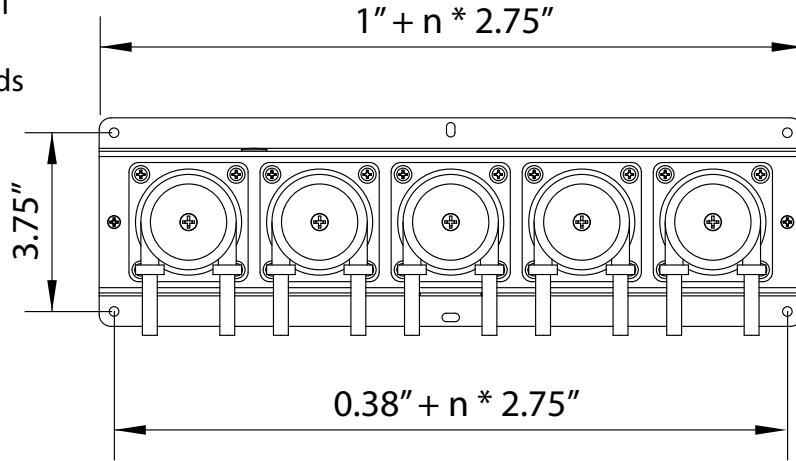

Installation Instructions

Panel mounted systems bolt to wall surfaces using the four mounting holes located in the corners of the panel. Connect plumbing with 1" NPT PVC fittings.

Install with the connections facing down to reduce the risk of water permeating the enclosure.

Avoid locations with dripping water or heavy splash risk; the transmitter is best kept dry for longest life and highest accuracy.

A probe manifold with recirculating pump (3-30gpm) is recommended for best sensor accuracy.

IMPORTANT NOTE: For flow rates above 5 gpm, ensure probe tips are raised out of the flow path to prevent turbulence altering the sensor readings.

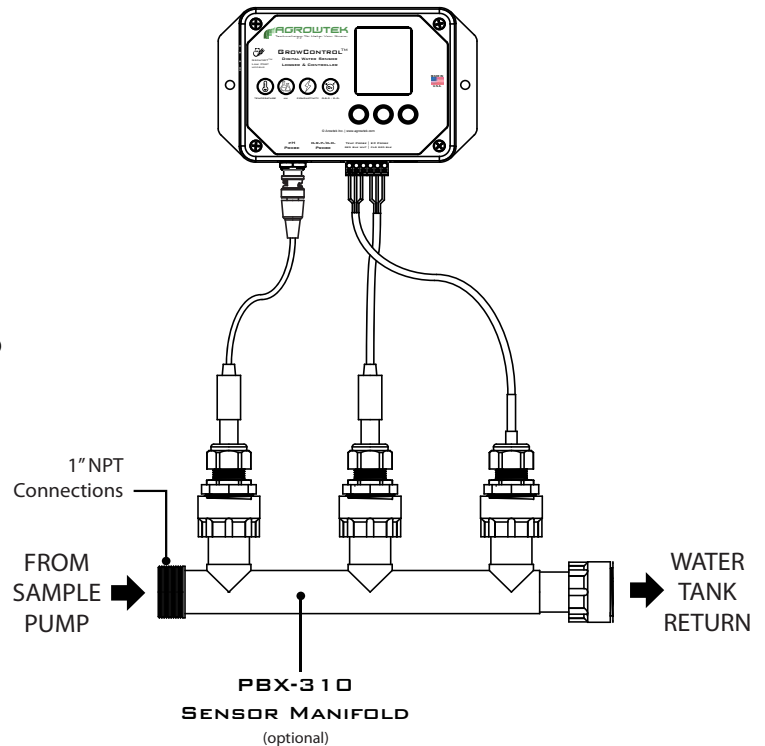
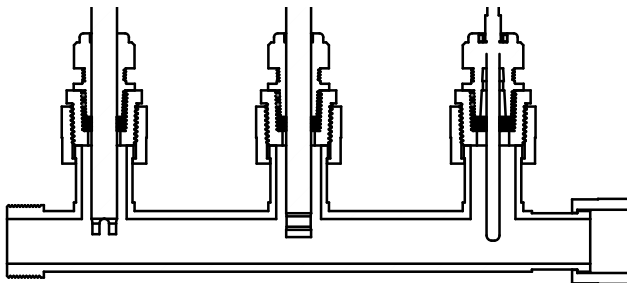

Mounting the Transmitter

Wall mounting tabs are provided for installing against a vertical wall surface.

1. Measure out the hole locations per the dimensions, or mark the holes using the transmitter as a template.
2. Drill holes and install anchors (if required, not included.) Keep the transmitter away from dust during work.
3. Install the transmitter to the wall surface using appropriate screws.

DIN Rail Mounting Kit

A DIN rail mounting kit installs onto the mounting flanges with the provided hardware for mounting the device on a standard DIN rail.

1. Screw the DIN rail brackets onto the flanges using the provided screws.
2. Snap the transmitter into place on a DIN rail.
3. Use the latches on the DIN brackets to release the transmitter from the DIN rail.



Mounting the Dosing Pump

Mount the pump on a vertical wall surface using the holes in the mounting flanges. The center flange hole may be used to hang and level the pump, however, the corner screw holes should be used for final mounting. Use caution to avoid over-tightening the screws and bending the flanges.

A 120Vac wall receptacle is required within 6ft of the pump for the power adapter.

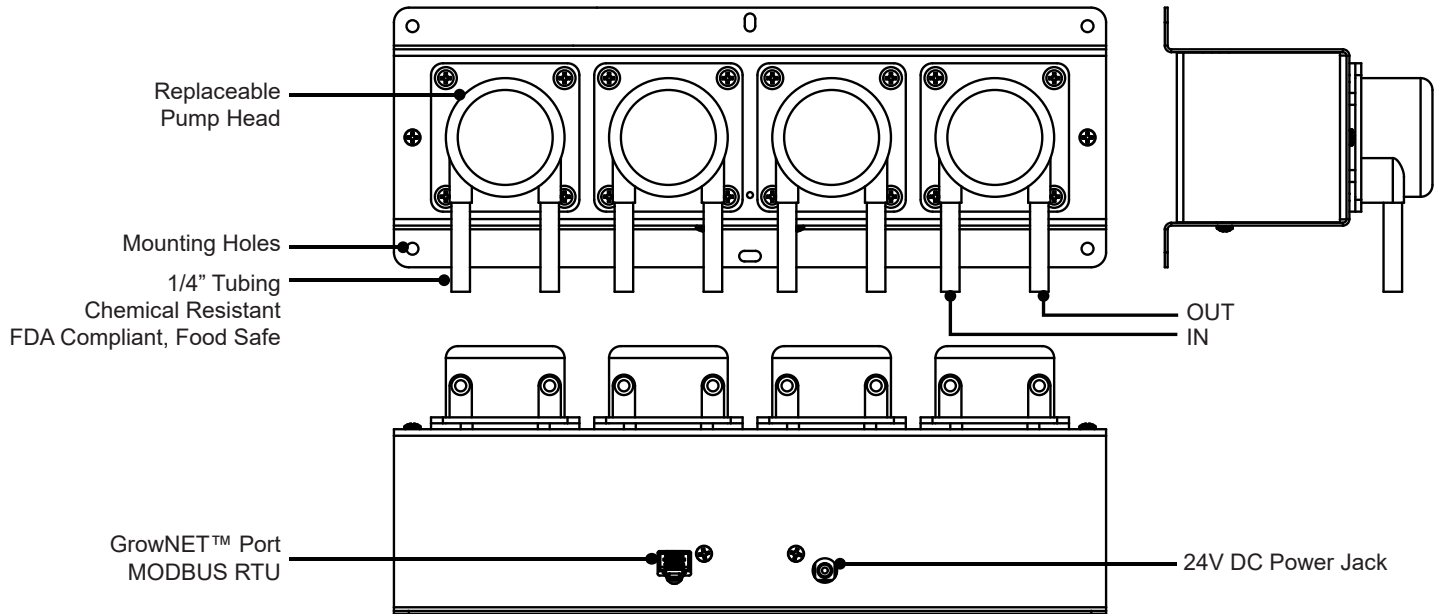

⚠ Do NOT connect the GrowNET port to Ethernet networks.

Connecting Pump Tubing

Each pump has an inlet (suction) and outlet (pressure) tube. Using included barbed tubing connectors, install an inlet tube for each pump into the respective concentrate container, then install an outlet tube to the mixing reservoir or injection manifold.

Shown with optional PBX-100 series injection manifold designed for easy installation with a re-circulating pump for continuous recycling.

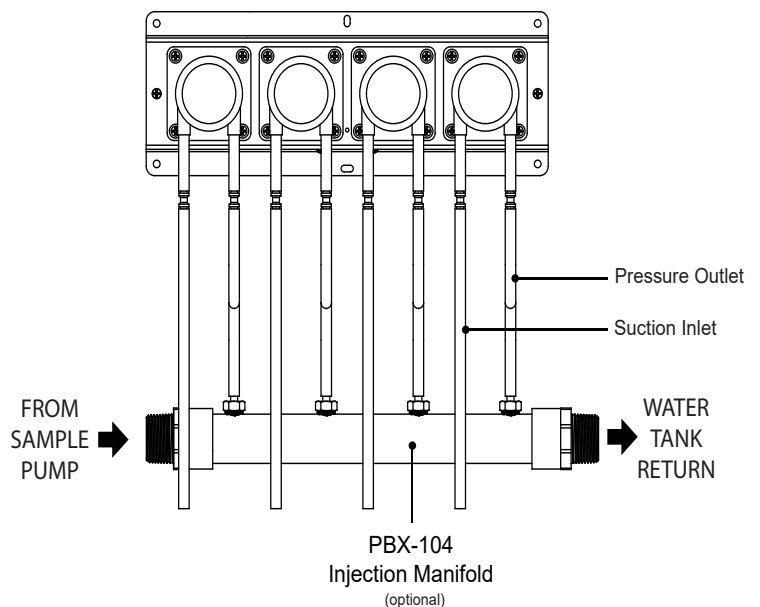

pH & ORP Probe Preparation

Probe Shipping & Storage

pH & ORP probes are shipped in a plastic bottle containing a solution of pH 4 buffer and potassium chloride. The electrode should remain in the bottle until it is used.

If the electrode is used infrequently, the bottle and its solution should be saved and the electrode stored in it. If the solution in the soaker bottle is missing, fill the bottle with pH 4 buffer.

Take out electrode by loosening plastic top on bottle counter-clockwise and pulling electrode out. Slide cap and O-ring off electrode and save.

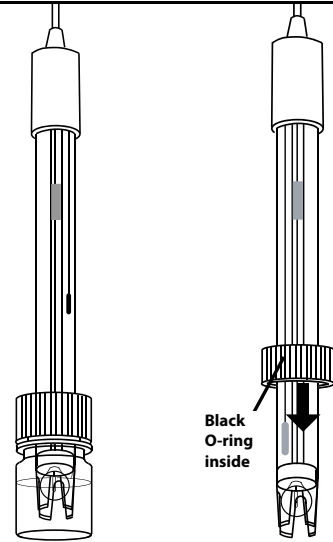

Air Bubble

During shipment the air bubble in the electrode's stem may move into the bulb area.

If bubbles are seen in the bulb area, hold the electrode by its top cap and shake while pointed downward.

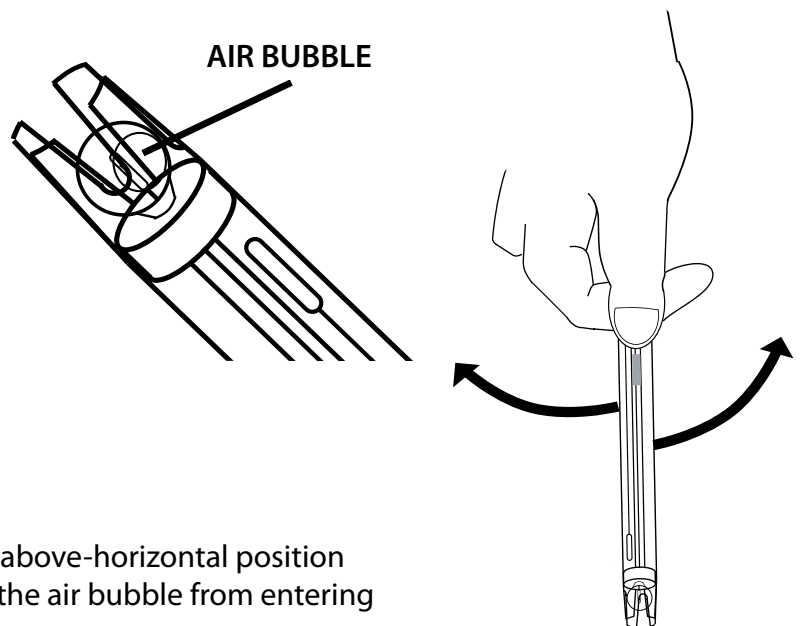

⚠ Installation/Operation Angle

pH & ORP sensor probes must be installed in an above-horizontal position with the probe tip facing downward to prevent the air bubble from entering the the bulb area.

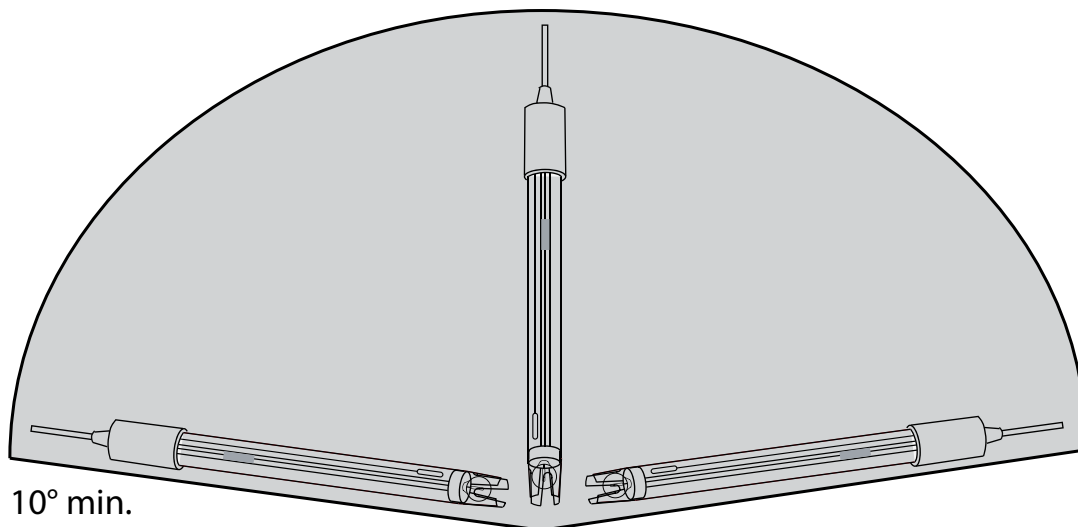

Operation Instructions

The SXH/M hydro sensor continuously monitors the sensor probes and compares the readings to “target” set points for pH, conductivity (EC) and ORP (optional.) If the readings are outside of the allowed range, the pumps will sequentially dose according to the configured recipe, repeating until the targets are achieved. Each pump has a programmable delay time to separate parts and/or add a delay between the cycles.

Definitions

Target

A “target” is a set-point that the system is looking to achieve such as maintaining 1000uS, 6.00pH or 400mV ORP. The targets are programmable for each sensor.

Dead Band

“Dead band” is the amount of drift allowed from the target before starting dosing cycles back to the target. For example: to allow a drift of 100uS (50ppm) from the nutrient concentration target, set the EC deadband value to “100uS” (50ppm,) or to allow a drift of 0.20 pH above or below the target, enter a pH deadband of “0.20.”

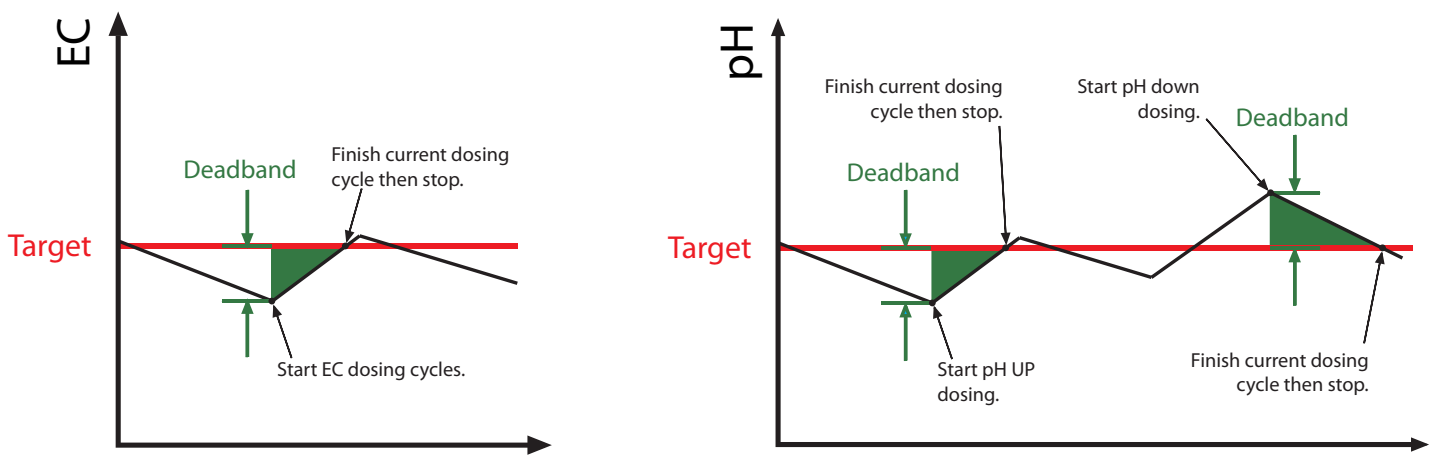

Recipe

Each pump is assigned a “type” (EC/pH/ORP,) a “mode” (up or down dosing,) a dose size (mL,) and a after-dose delay time (seconds.) Pumps can be configured in any order, but the system will still follow the standard dosing cycle flow chart as shown on the following page.

EC LOCK-OUT (for pH pumps)

EC LOCK is a menu option that appears on pumps assigned to pH control. EC LOCK prevents pH dosing while EC targets are not satisfied and nutrient dosing is on-going.

pH LOCK-OUT (for ORP pumps)

pH LOCK is a menu option that appears on pumps assigned to ORP control. pH LOCK prevents ORP dosing while pH targets are not satisfied and pH dosing is on-going.

Delay

Every pump has a configurable “delay” time setting which occurs after the pump doses and before continuing to the next pump in the sequence. See dosing cycle flow chart on the following page for more details.

Dosing Cycles

EC Dosing

The system begins by checking the EC against the target set point. If the sensor reading is outside of the target range, the pump will begin a nutrient dosing cycle. The cycle starts by checking the first (left most) pump to see if it is assigned to nutrient control (EC mode.) If it is, the pump's recipe volume is dosed followed by a pause for the pump delay time if one is set. The system then progresses to the next pump and continues to dose each remaining "EC pump" before proceeding to check the pH.

pH & ORP Dosing

The system then checks the pH value to see if it is with the target range. If the pH requires adjustment, each pump is checked (starting with the first) if it is assigned to pH (up or down) and if so, the recipe dose is administered. Once all the pumps are checked for pH dosing, if equipped, ORP follows in the same fashion. pH or ORP dosing may be paused if the EC or pH locks are set respectively.

EC LOCK option prevents pH dosing from starting while EC is not in the target range.

pH LOCK option prevents ORP from dosing while pH is not in the target range.

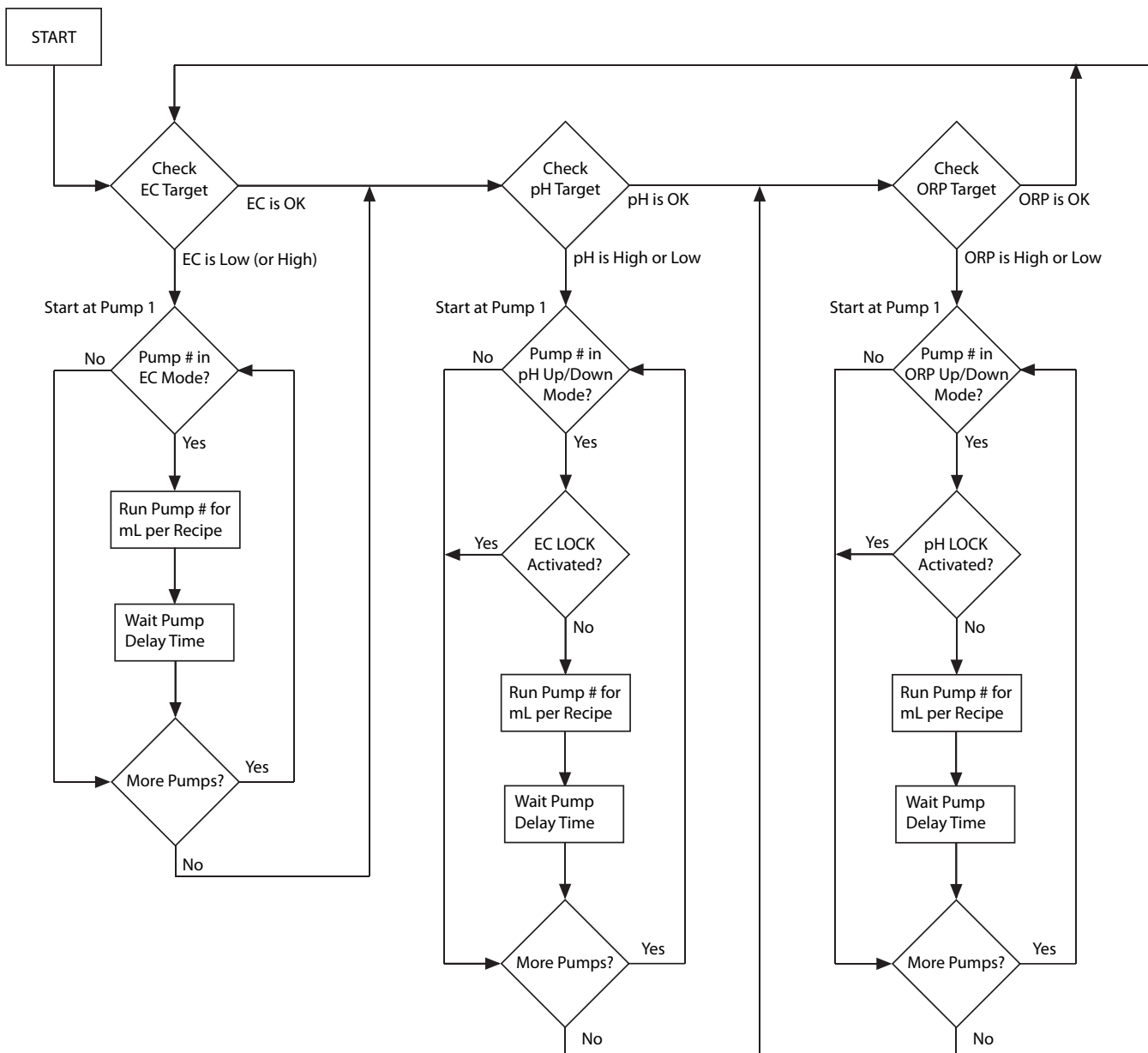

Controller Operation, Sensors

3-button/LCD display interface allows easy monitoring of sensor values.

Simple menu driven setup for configuring pump recipes, system settings, sensor calibration and more.

The main screen displays the real-time sensor readings from the attached sensors.

Each button is labeled at the bottom of the display to describe its function on the current screen or menu.

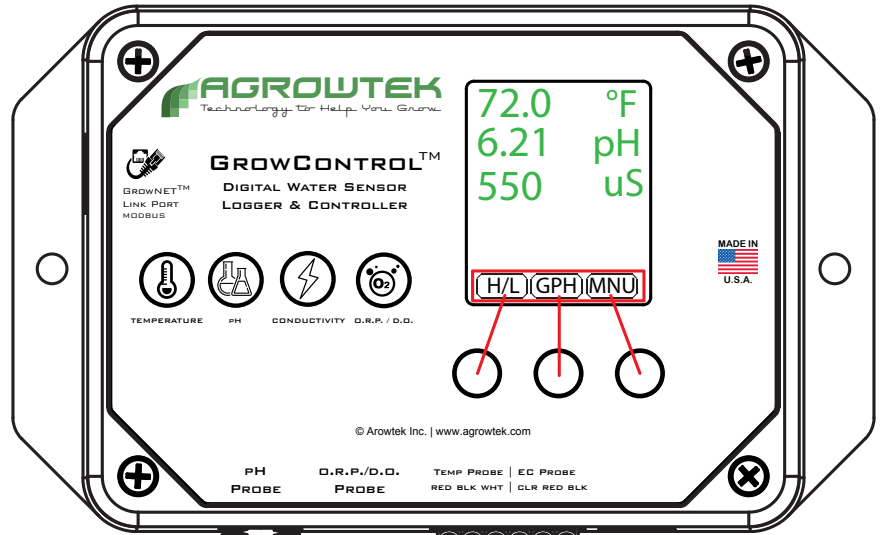

High / Low History

H/L

Simple minimum and maximum recorded values are stored until the user resets the values to the current readings. To view the minimum and maximum values since the last reset, press the button labeled H/L.

To clear the min/max history, press the RST button to reset. The min and max values will all be set to the current readings and will update with higher or lower readings as they occur.

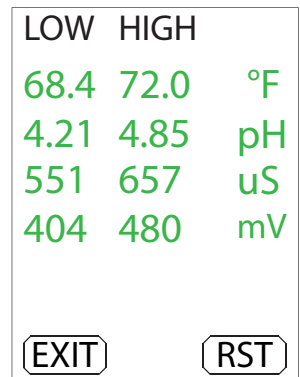

Graphing

GPH

The display can graph the most recent 120 data points from the sensor's internal data point memory. With the default logging interval of 60 seconds, the graph displays the last two hours of data.

The sensor value is plotted in green. Temperature, if overlaid on the plot, is red. Alarm levels as set by the user are plotted in yellow. Pressing the RFH button refreshes the data and replots the graph.

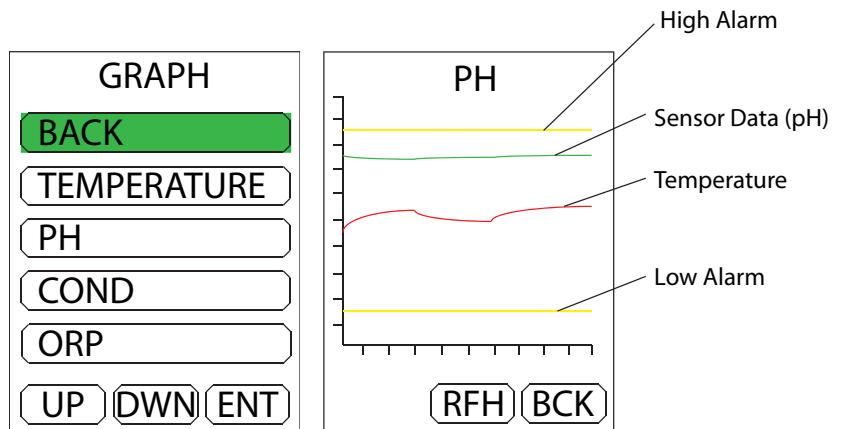

Main Menu

MNU

The main menu is how the alarms are set, sensors are calibrated and general settings such as time, date and units are configured.

If a dosing pump is directly connected to the SXHM GrowNET port, the pump settings are also accessed by the main menu.

Use the UP or DWN buttons to navigate the menu.

Use the ENT button to enter a selection.

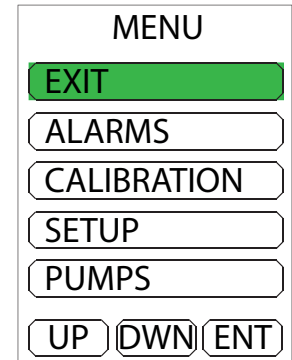

Alarms Menu

MNU ► ALARMS

High and low alarm set points may be configured for each sensor value to activate an internal buzzer or send alerts with the optional wifi module.

The out-of-range value will be displayed in red to indicate the cause for the alarm.

Additionally, alarm limits are plotted on the graphs to indicate values are within the desired range.

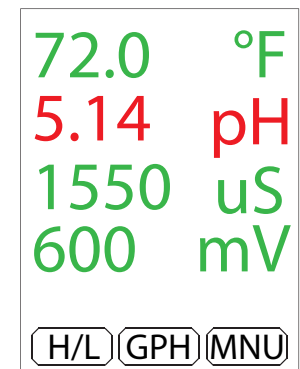

Alarms Configuration

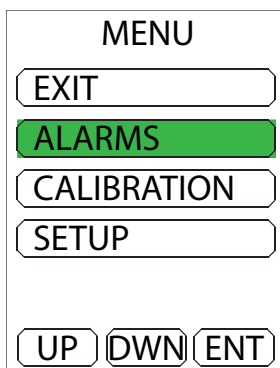

1. Select **ALARMS** from the main menu.

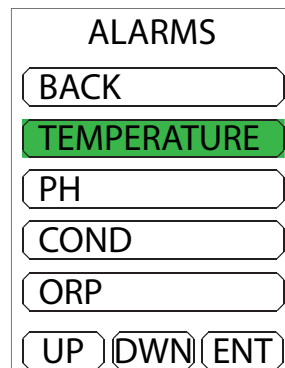

2. Select a sensor to configure set points.

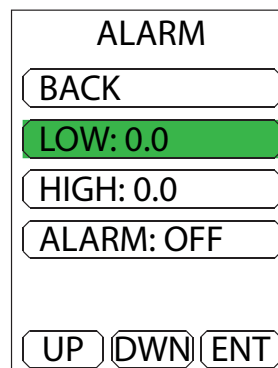

3. Select the setting to adjust.

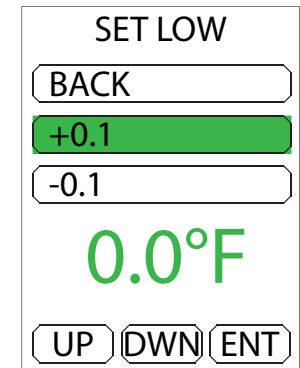

4. Adjust to the desired value. Hold UP or DWN to jog the value.

Alarm Buzzer

ALARM

BACK

LOW: 0.0

HIGH: 0.0

ALARM: OFF

UP DWN ENT

1. Select **ALARM: OFF**

SET ALARM

BACK

SET ON

SET OFF

OFF

UP DWN ENT

2. Select **SET ON** then press **BACK** to exit.

To disable the alarm buzzer, set the alarm to OFF.

Calibration Menu

MNU ► CALIBRATION

Calibration can be performed for each sensor with the LCD interface using either standard calibration wizards, or advanced manual calibration methods for non-standard calibration solutions.

The date of the last calibration for each sensor is stored in memory and displayed at the start of each calibration wizard.

MENU

EXIT

ALARMS

CALIBRATION

SETUP

UP DWN ENT

CALIBRATION

BACK

TEMPERATURE

PH

COND

CLEAR ALL

UP DWN ENT

Temperature Calibration

MNU ► CALIBRATION ► TEMPERATURE

CALIBRATION

BACK

CALIBRATE

ADVANCED

UP DWN ENT

1. Select **CALIBRATE** from the temperature calibration menu.

TEMPERATURE
LAST CALIBRATION
10/19/2017

PRESS NEXT TO
ADJUST
TEMPERATURE
READING.

EXIT NEXT

2. Press **NEXT** to continue.

OFFSET

BACK

+0.1

-0.1

72.2°F

UP DWN ENT

3. Adjust to the desired value. Hold **ENT** to jog the value by 10x.

CONFIRM?

OLD
68.1 °F

NEW
72.2 °F

YES NO

4. Confirm the new reading or press **NO** to cancel.

pH Calibration

MNU ► CALIBRATION ► PH

pH calibration is a two-point process requiring both pH 7 and pH 4.01 calibration solutions. The temperature probe must be inserted into the calibration solution at the same time as the pH probe.

CALIBRATION

BACK

CALIBRATE

ADVANCED

UP DWN ENT

1. Select **CALIBRATE** from the pH calibration menu.

PH

LAST CALIBRATION
10/19/2017

STEP 1:
PUT TEMPERATURE
AND PH PROBE IN
PH7 SOLUTION.

EXIT NEXT

2. Follow the instructions then press **NEXT** to continue.

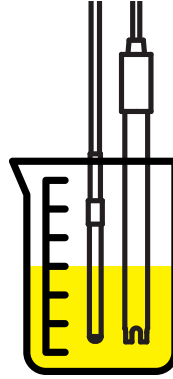

pH 7 Calibration Solution

PH

7.12 pH

WAIT FOR READING
TO STABILIZE THEN
PRESS NEXT.

EXIT NEXT

3. When the reading is stable, press **NEXT** to calibrate pH 7.

PH

7.00 pH

STEP 2:
PUT TEMPERATURE
AND PH PROBE IN
PH4.01 SOLUTION.

EXIT NEXT

4. Clean the probes with DI/RO and change calibration solution.

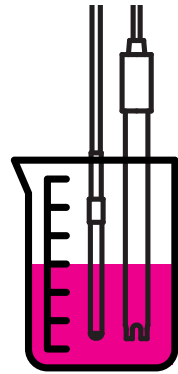

pH 4.01 Calibration Solution

PH

4.14 pH

WAIT FOR READING
TO STABILIZE THEN
PRESS DONE.

EXIT DNE

5. When the reading is stable, press **DONE** to calibrate pH 4.01 and finish calibration.

Conductivity Calibration

(MNU) ► (CALIBRATION) ► (COND)

Conductivity calibration is a single point process requiring 1413 uS calibration solution. The temperature probe must be inserted into the calibration solution at the same time as the conductivity probe.

CALIBRATION
(BACK)
(CALIBRATE)
(ADVANCED)

(UP) (DWN) (ENT)

1. Select **CALIBRATE** from the conductivity calibration menu.

CONDUCTIVITY
LAST CALIBRATION
10/19/2017
PUT TEMPERATURE
AND EC PROBE IN
1413uS SOLUTION.

(EXIT) (NEXT)

2. Follow the instructions then press **NEXT** to continue.

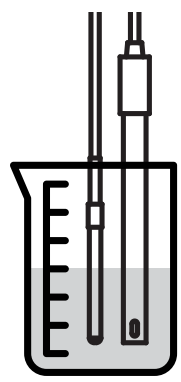

CONDUCTIVITY
1440 uS
WAIT FOR READING
TO STABILIZE THEN
PRESS DONE.

(EXIT) (DNE)

3. When the reading is stable, press **DONE** to complete the calibration.

O.R.P. Calibration

(MNU) ► (CALIBRATION) ► (NEXT) ► (ORP)

ORP (optional) calibration is a single point process requiring 470 mV calibration solution.

CALIBRATION
(BACK)
(CALIBRATE)
(ADVANCED)

(UP) (DWN) (ENT)

1. Select **CALIBRATE** from the conductivity calibration menu.

ORP
LAST CALIBRATION
10/19/2017
PUT ORP PROBE IN
470mV SOLUTION.

(EXIT) (NEXT)

2. Follow the instructions then press **NEXT** to continue.

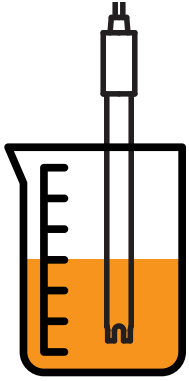

CONDUCTIVITY
1440 uS
WAIT FOR READING
TO STABILIZE THEN
PRESS DONE.

(EXIT) (DNE)

3. When the reading is stable, press **DONE** to complete the calibration.

Clear Calibration

MNU ► CALIBRATION ► NEXT

Calibration can be restored to factory defaults by selecting **CLEAR ALL**.

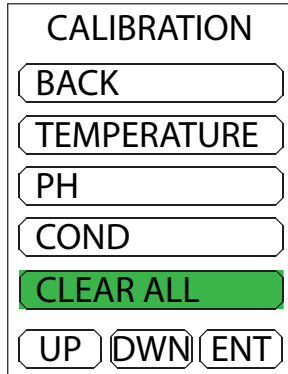

1. Select **CLEAR ALL** from the calibration menu.

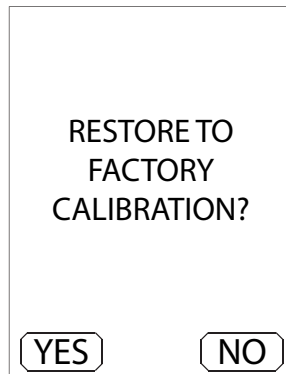

2. Press **YES** to restore factory calibration.

Advanced Calibration

Sensors values may be manually calibrated to alternate standards using the advance calibration features.

OFFSET calibration applies a linear offset adjustment to the value.
SPAN calibration applies an adjustment to the slope of the sensor value.

Note: pH and conductivity are temperature compensated (ATC) sensors. For accurate calibration, the temperature probe must be in the pH and conductivity calibration standards. Allow all readings to stabilize before performing an offset or span calibration operation.

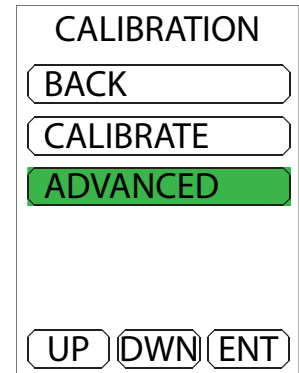

PH

CAL 7 sets the pH 7 calibration (offset.) Cal 7 automatically clears span calibration point prior performing pH 7 calibration.

SPAN calibration is performed typically at pH 4.01 or 10.0 (*Always perform pH 7 calibration first.*)

CONDUCTIVITY

SET CAL 0 calibrates a dry EC probe if required. (not recommended)

SPAN calibration is recommended at 1413uS. If using ppm standards, ensure the display is in the correct units.

DISSOLVED OXYGEN (D.O.)

OFFSET calibration is recommended in zero oxygen solution.

SPAN calibration is recommended at a known DO level or in air.

OXIDATION REDUCTION POTENTIAL (O.R.P.)

OFFSET is recommended at 270mV

SPAN is recommended at 470mV

Analog Output Calibration

4-20mA analog outputs may also be calibrated with a positive or negative offset to compensate for variation in DAC's/ADC's. The sensors' current output may be incrementally increased or decreased in steps of 0.005mA over a range of +/-2mA.

1 Offset bit = 0.005mA, Range = +/-400 bits (+/-2mA)

This calibration procedure is optional and only for use with custom PLC applications.

1. Observe the PLC's input or data readings.
2. Increase or decrease the offset value to incrementally adjust the current output until the values match.

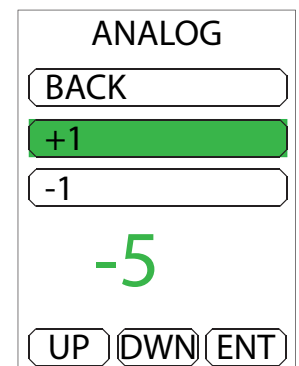

Setup Menu

(MNU) ► (SETUP)

The setup menu is where the time and date are set, the units are configured, logging interval is adjusted and advanced communications settings are available.

SETUP
BACK
TIME/DATE
UNITS
LOG INTERVAL
NEXT
UP DWN ENT

SETUP
BACK
COMM
DEVICE ADD
MFG INFO
BACKLIGHT
UP DWN ENT

Time / Date

(MNU) ► (SETUP) ► (TIME/DATE)

Sensors include a precision real-time clock with battery back-up for time-stamping the data log information with the time and date. The last calibration for each sensor is also time stamped.

SETUP
BACK
TIME/DATE
UNITS
LOG INTERVAL
NEXT
UP DWN ENT

1. Select **TIME/DATE** from the setup menu.

TIME/DATE
BACK
TIME
DATE
UP DWN ENT

2. Select **TIME** or **DATE** to adjust.

TIME
13:37:51
NXT + EXT

3. Use **NXT** to select the value to adjust. Use **+** to increment the value.

DATE
10/20
2017
NXT + EXT

4. Use **EXT** to exit the menu.

Units

(MNU) ► (SETUP) ► (UNITS)

Temperature and Conductivity may be displayed in alternate units.

Select a sensor value to change the default display and working units.

SETUP
BACK
TIME/DATE
UNITS
LOG INTERVAL
NEXT
UP DWN ENT

UNIT SELECT
BACK
TEMPERATURE
EC
UP DWN ENT

Configure temperature units:

Temperature may be displayed in °F or °C.

Note: Check alarm settings when converting temperature units.

UNIT SELECT

BACK

TEMPERATURE

EC

UP DWN ENT

1. Select **TEMPERATURE** from the units menu.

UNIT SELECT

BACK

°C

°F

68.0°F

UP DWN ENT

2. Select the desired units and press **ENT**.

Configure conductivity units:

Conductivity may be displayed in default units of microSiemens (uS) or total dissolved solids in parts per million (ppm.)

The TDS conversion factor used by this meter is 500.

$$\text{TDSppm} = \text{uS} \times 0.5$$

UNIT SELECT

BACK

TEMPERATURE

EC

UP DWN ENT

1. Select **EC** from the units menu.

UNIT SELECT

BACK

US

TDS

654 ppm

UP DWN ENT

2. Select the desired units and press **ENT**.

Logging Interval

MNU ► **SETUP** ► **LOG INTERVAL**

Adjust the interval for recording data points in the on-board memort. Acceptable values are from 1 - 65535 seconds.

21,600 data points can be stored for each sensor value. The most recent 120 data points are shown on the graphical history.

The entire data history may be downloaded from the sensor to a .csv file with the LX1 USB AgrowLINK and free software.

Note: 60 second intervals = 15 days of data storage.

SETUP

BACK

TIME/DATE

UNITS

LOG INTERVAL

NEXT

UP DWN ENT

1. Select **LOG INTERVAL** from the setup menu.

LOGGIN INTERVAL

BACK

+1

-1

60 SEC

UP DWN ENT

2. Adjust the value then select **BACK**.

COMM Mode

(MNU) ► (SETUP) ► (NEXT) ► (COMM)

COMM mode specifies whether the sensor is a normal passive device or “mini-master” device.

NORMAL Use with GrowControl master controller systems or stand-alone and data logging applications.

MINI-MASTER Use with MDX mini-dosing system. (GrowNET cross-over adapter required.)

SETUP

(BACK)

(COMM)

(DEVICE ADD)

(MFG INFO)

(UP) (DWN) (ENT)

COM MODE

(NORMAL)

(MINI MASTER)

(UP) (DWN) (ENT)

Device Address

(MNU) ► (SETUP) ► (NEXT) ► (DEVICE ADD)

Sensors are digitally addressable from 1-249 and will be assigned an address automatically by Agrowtek’s control systems, or can be configured manually for MODBUS applications via the menu.

NOTE: All of Agrowtek’s devices use address 254 as a broadcast address.

SETUP

(BACK)

(COMM)

(DEVICE ADD)

(MFG INFO)

(BACKLIGHT)

(UP) (DWN) (ENT)

DEVICE ADDRESS

(BACK)

(+1)

(-1)

0 Addr

(UP) (DWN) (ENT)

1. Select **DEVICE ADD** from the setup menu.

2. Adjust the value then select **BACK**.



NOTE: Address must be set to 0 for Dosing Pump control.

The “PUMPS” menu item will not appear unless the device address is set to 0.

Manufacturing Info

(MNU) ► (SETUP) ► (NEXT) ► (MFG INFO)

Manufacturer information such as serial number, date of manufacture, hardware and firmware versions can be read from the MFG INFO page.

SETUP

(BACK)

(COMM)

(DEVICE ADD)

(MFG INFO)

(BACKLIGHT)

(UP) (DWN) (ENT)

SERIAL NUMBER:
17090554
DATE OF MFG:
09/15/17
HW VERSION:
C
FW VERSION:
02.03.84
(EXIT)

Display Back Light Timer

MNU ► SETUP ► NEXT ► BACKLIGHT

The display back light can be programmed to turn off after a specified time of inactivity from the last time a button is pressed.

The delay can be set from 1-255 minutes, or set to 0 to disable the back light timer and keep the display on continuously.

SETUP

BACK

COMM

DEVICE ADD

MFG INFO

BACKLIGHT

UP DWN ENT

BACKLIGHT

BACK

+1

-1

60 Min

UP DWN ENT

Controller Operation, Pumps

MDX dosing systems have a "PUMPS" menu for configuring the control settings for peristaltic pumps.

Dosing Pump Control Menu

(MNU) ► (PUMPS)

The PUMPS menu is displayed when the hydro sensor is connected to a dosing pump and contains all of the configuration, target and recipe settings pages for controlling the pumps.

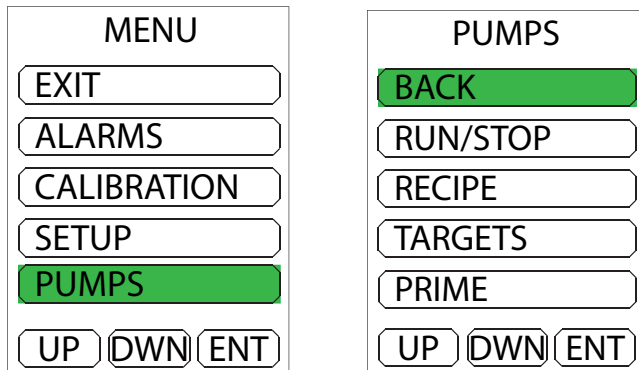

 The "Pumps" menu item will not appear unless the communication mode is set to "MINI-MASTER" and the device address is set to "0" (see COMM MODE and DEVICE ADDRESS.)

Priming

(MNU) ► (PUMPS) ► (PRIME)

Pumps may be manually operated to prime the lines or for other maintenance reasons. From the Prime menu, select a pump to prime. Pumps may be operated in the forward or reverse direction.

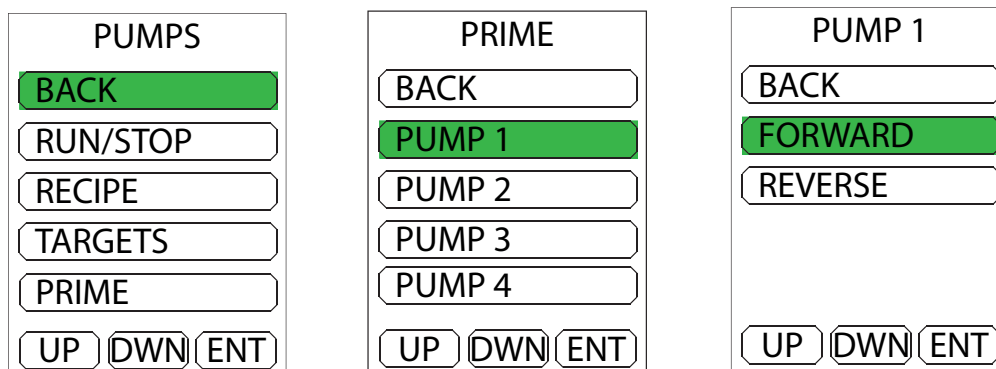

1. Select **NEXT** from the PUMPS menu.

2. Choose a pump to operate.

3. Select a direction and **HOLD** the **ENT** button. Release the button to stop.

Run/Stop

(MNU) ► PUMPS ► RUN/STOP

The dosing pumps must be placed into RUN mode for autonomous dosing to take place. The dosing pumps may be immediately disabled to stop a dosing operation due to an error, nutrient outage, or maintenance requirement. To stop all dosing pumps and prevent autonomous operation, place the pump into STOP mode.

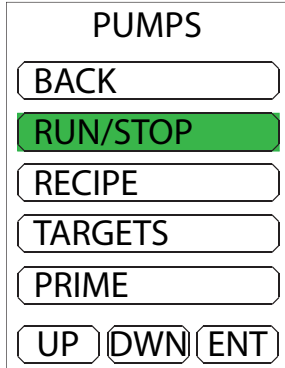

The RUN/STOP menu enables or disables the pumps

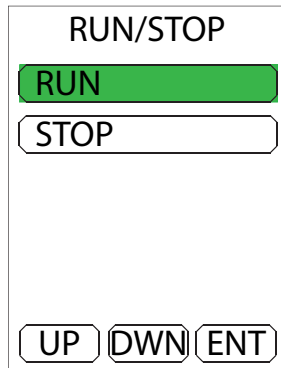

Select **RUN** to allow the pumps to operate based on your settings.

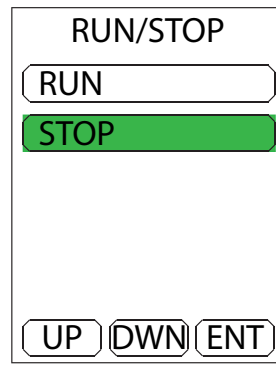

Select **STOP** to disable the pumps from running automatically and to abort any current operation.

Recipe Menu

(MNU) ► PUMPS ► RECIPE

Each pump is configured with a “recipe” containing the pump mode (EC or pH) and dose volume (mL.)

MDX systems are available with 1, 2 or 4 dosing pump heads and each may be configured for EC or pH control in any order or combination.

NOTE: Dosing will occur from the lowest to the highest numbered pump when more than one pump is in the same mode (EC, pH-UP or PH-DOWN.)

Select a pump number to configure the recipe settings as described below.

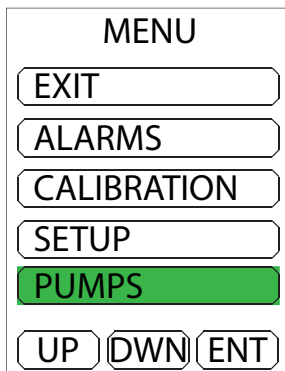

1. Select **PUMPS** to configure the pumps.

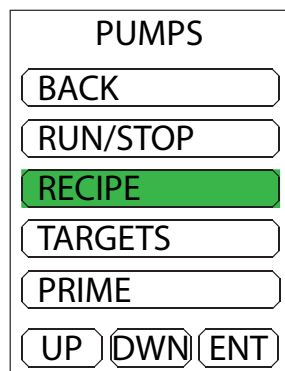

2. Select **RECIPE** to configure the pump parts.

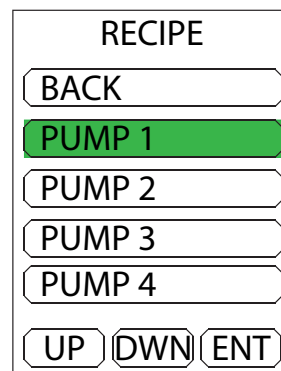

3. Select a pump to configure its mode and dose size.

Pump Mode

MNU ► PUMPS ► RECIPE ► PUMP 1

Pumps may be configured for EC/ppm (nutrients,) pH or ORP dosing control. Pumps may be set to dose in the up or down direction as required. Pump modes are configured under the “recipe” menu.

If the pump is not in use, select OFF mode to disable it from autonomous control.

RECIPE

BACK

PUMP 1

PUMP 2

PUMP 3

PUMP 4

UP DWN ENT

1. Select a pump.

PUMP 1

BACK

PUMP MODE

DOSE SIZE

DELAY

UP DWN ENT

2. Select **PUMP MODE**.

PUMP MODE

BACK

TYPE

MODE

UP DWN ENT

3. Select **TYPE** to choose the sensor type.

PUMP TYPE

OFF

EC

PH

ORP

UP DWN ENT

4. Set the pump to the desired sensor type.

PUMP MODE

BACK

TYPE

MODE

UP DWN ENT

3. Select **MODE** to choose the dose mode.

PUMP MODE

DOSE UP

DOSE DOWN

UP DWN ENT

4. Select **UP** or **DOWN** dosing mode.

Dose Size

MNU ► PUMPS ► RECIPE ► PUMP 1

Each pump can be assigned a unique dose volume in mL to be injected in sequence. It is recommended to set the volumes to a one gallon quantity so that the pumps inject chemicals for 1 gallon of water at a time. Typical feeding charts suggest mL/gal; set each pump to this mL value.

Some experimentation with dose sizes may be required to determine the best settings for your process. Select a dose size that will not cause over-dosing of the reservoir if one extra cycle is performed.

PUMPS

BACK

RUN/STOP

RECIPE

TARGETS

PRIME

UP DWN ENT

1. Select **RECIPE** to configure the dose.

RECIPE

BACK

PUMP 1

PUMP 2

PUMP 3

PUMP 4

UP DWN ENT

2. Select a pump.

PUMP 1

BACK

PUMP MODE

DOSE SIZE

DELAY

UP DWN ENT

3. Select **DOSE SIZE**.

DOSE SIZE

BACK

+1

-1

100 mL

UP DWN ENT

4. Set the pump to the desired mode.

Delay Time

MNU ► PUMPS ► RECIPE ► PUMP 1

Each pump may have a delay time set after it to separate parts and to pause between cycles to allow a sensor reading to take place. It is recommended to set at least 5 minutes after the last pump of each sensor type to allow mixing time of the previous dose. Adjust the delays according to your system size and water usage.

PUMPS

BACK

RUN/STOP

RECIPE

TARGETS

PRIME

UP DWN ENT

1. Select **RECIPE** from the **PUMPS** menu.

RECIPE

BACK

PUMP 1

PUMP 2

PUMP 3

PUMP 4

UP DWN ENT

2. Select a pump.

PUMP 1

BACK

PUMP MODE

DOSE SIZE

DELAY

UP DWN ENT

3. Select **DELAY**.

DELAY

BACK

+1

-1

90 SEC

UP DWN ENT

4. Set the delay time after the pump doses.

EC Lock-Out

MNU ► PUMPS ► RECIPE ► PUMP 1

If PUMP TYPE is set to PH, the EC LOCK option will appear in the recipe menu for that pump. If the lock is set to "ON" the system will lock-out this pump until EC dosing has completed.

Set the EC LOCK to ON to only allow the pH pump to operate after EC dosing has reached the target.
Set the EC LOCK to OFF to allow a pH dosing cycle after each EC dosing cycle (as required.)

MENU		
EXIT		
ALARMS		
CALIBRATION		
SETUP		
PUMPS		
UP	DWN	ENT

1. Select **PUMPS** to configure the pumps.

RECIPE		
BACK		
PUMP 1		
PUMP 2		
PUMP 3		
PUMP 4		
UP	DWN	ENT

2. Select a pump.

PUMP 1		
BACK		
PUMP MODE		
DOSE SIZE		
DELAY		
EC LOCK		
UP	DWN	ENT

3. Select **EC LOCK**.

EC LOCK		
BACK		
LOCK		
UNLOCK		
ON		
UP	DWN	ENT

4. Set the pump to the desired mode.

pH Lock-Out

MNU ► PUMPS ► RECIPE ► PUMP 1

If PUMP TYPE is set to ORP, the PH LOCK option will appear in the recipe menu for that pump. If the lock is set to "ON" the system will lock-out this pump until pH dosing has completed.

Set the EC LOCK to ON to only allow the ORP pump to operate after pH dosing has reached the target.
Set the EC LOCK to OFF to allow a ORP dosing cycle after each pH dosing cycle (as required.)

MENU		
EXIT		
ALARMS		
CALIBRATION		
SETUP		
PUMPS		
UP	DWN	ENT

1. Select **PUMPS** to configure the pumps.

RECIPE		
BACK		
PUMP 1		
PUMP 2		
PUMP 3		
PUMP 4		
UP	DWN	ENT

2. Select a pump.

PUMP 1		
BACK		
PUMP MODE		
DOSE SIZE		
DELAY		
PH LOCK		
UP	DWN	ENT

3. Select **EC LOCK**.

EC LOCK		
BACK		
LOCK		
UNLOCK		
ON		
UP	DWN	ENT

4. Set the pump to the desired mode.

Target Value

MNU ► PUMPS ► TARGETS ► PUMP 1

The target pH, ORP or EC set point is what the system will attempt to maintain by following the dosing “re- ceipe” settings. Set the desired ideal target values for EC and pH.

1. Select **TARGETS** in the **PUMPS** menu.

2. Select a sensor to setup the target value.

3. Select **TARGET**.

4. Set the target value for the sensor.

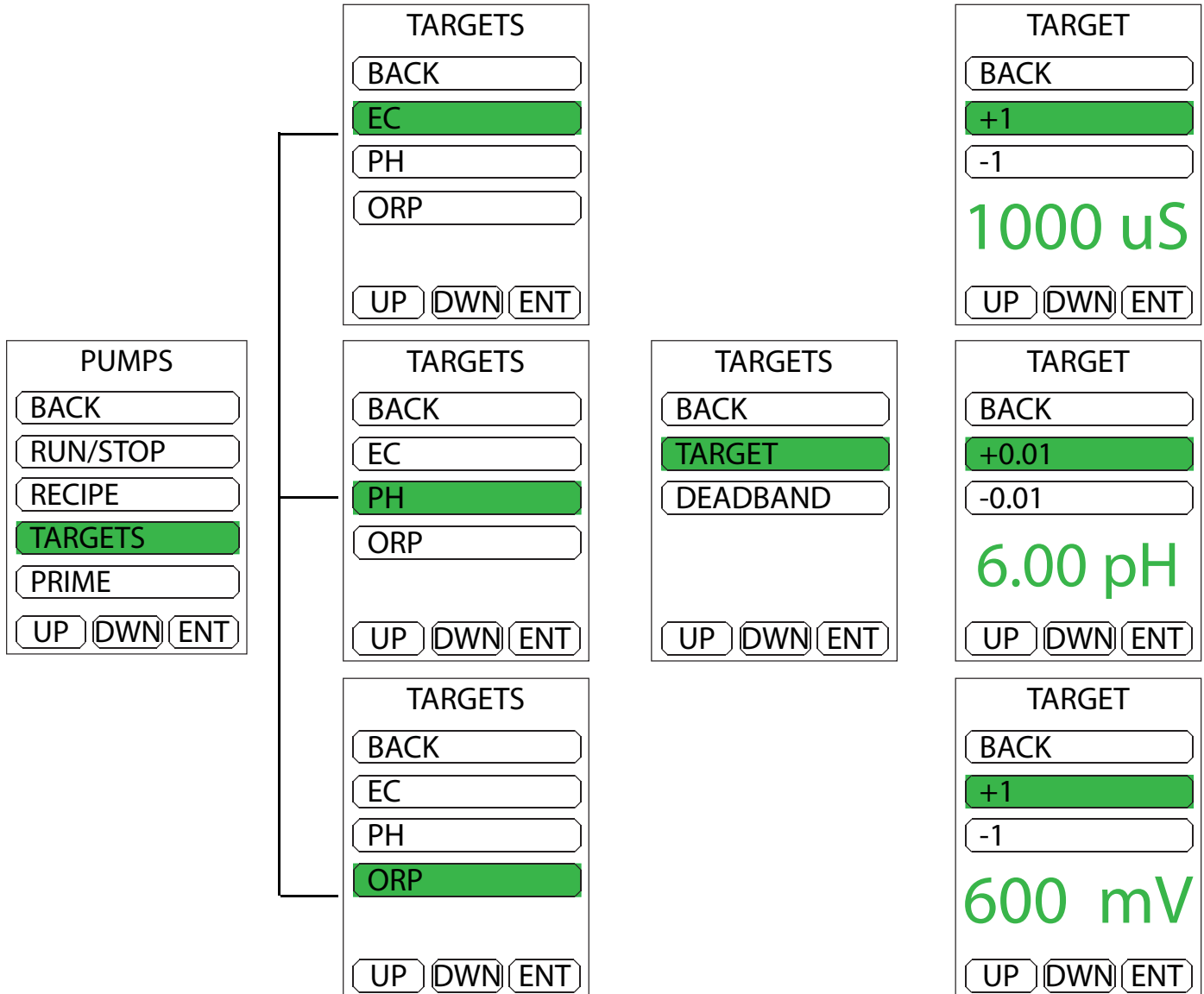

Deadband

MNU ► PUMPS ► TARGETS ► PUMP 1

Deadband is the amount of change or drift from the target before the system takes action. Set the deadband for EC and pH with the amount of drift that is allowed by your process requirements.

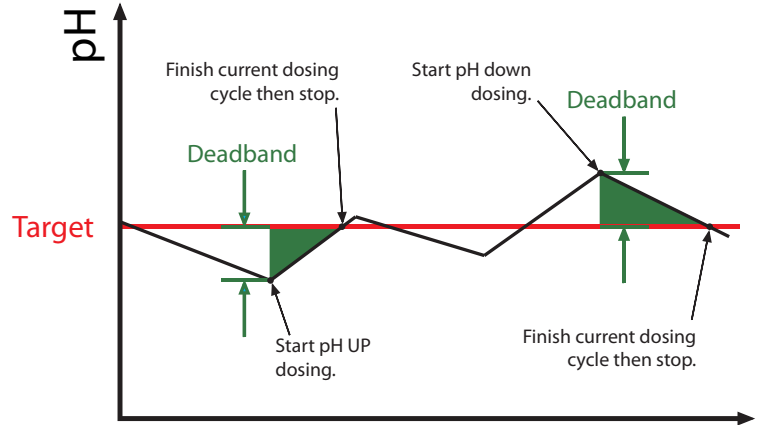
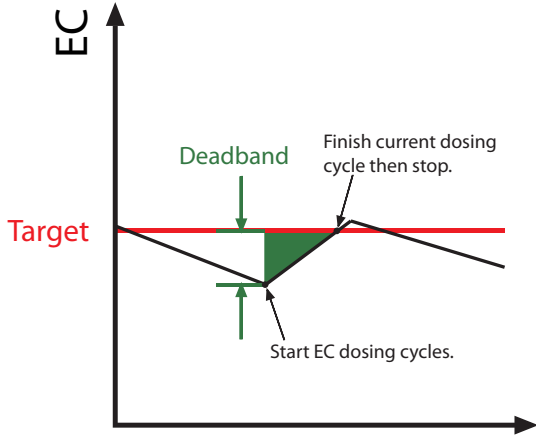

1. Select a sensor to set the deadband value.

2. Select DEADBAND

3. Set the deadband value for the sensor.

TARGETS

BACK

EC

PH

ORP

UP DWN ENT

TARGETS

BACK

TARGET

DEADBAND

UP DWN ENT

DEADBAND

BACK

+1

-1

100 uS

UP DWN ENT

TARGETS

BACK

EC

PH

ORP

UP DWN ENT

TARGETS

BACK

TARGET

DEADBAND

UP DWN ENT

DEADBAND

BACK

+0.01

-0.01

0.50 pH

UP DWN ENT

Connection to USB AgrowLINK

LX1 USB AgrowLINK connects Agrowtek's devices to a computer's USB port for:

- Firmware Updates
- Calibration
- Configuration
- Data Logging Download
- More

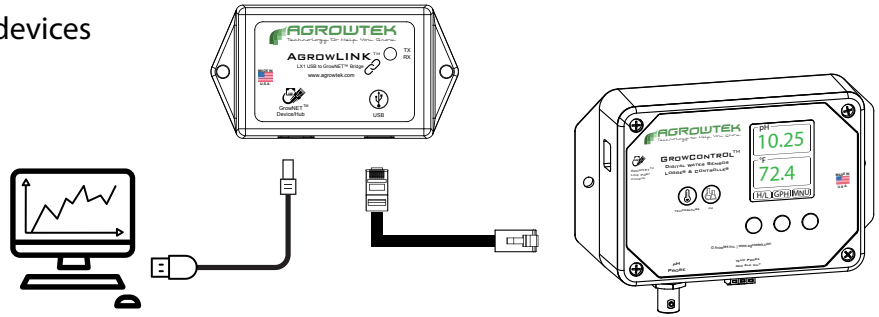

Firmware Update

Firmware updates are fast and easy on Agrowtek devices. Firmware files have a ".bin" extension.

Download and install the [AgrowLINK Utility](#).

1. Click: "File..." button and select the .bin firmware file.

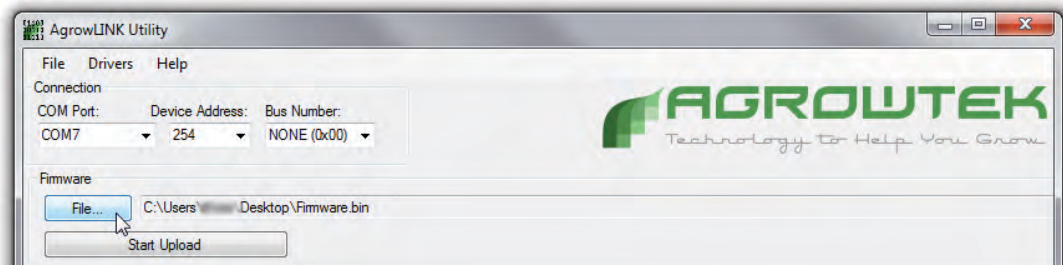

2. Ensure the device is powered on and connected to the LX1 USB Link.

3. Click the "Start Update" button.

IMPORTANT NOTE:

Firmware update capabilities are disabled 30 seconds after a device is powered on!
If the utility fails to "synchronize" with the device; un-plug the device powering it off, then plug it back in.

4. The firmware will begin downloading onto the device.

5. When complete, the message "Now launching the brand new code" will be displayed.

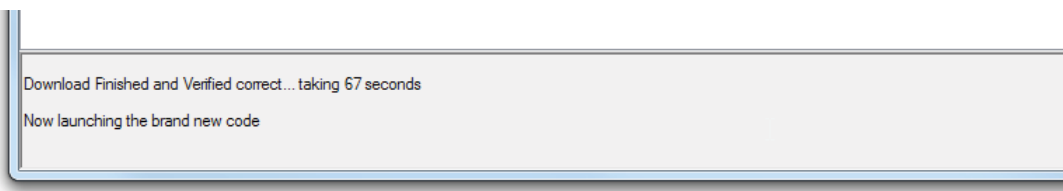

When the program displays "Now launching the brand new code" the update is complete.

Allow 10 seconds for the device to reboot, then perform tests according to the device type to verify the device is working properly after the update.

Load a Configuration File

The **AgrowLINK Utility** can quickly load customized configuration settings files through the USB AgrowLINK. The files are plain text and can be edited using notepad or any similar text editor. Sample configuration files are provided with the AgrowLINK utility can can be copied and edited.

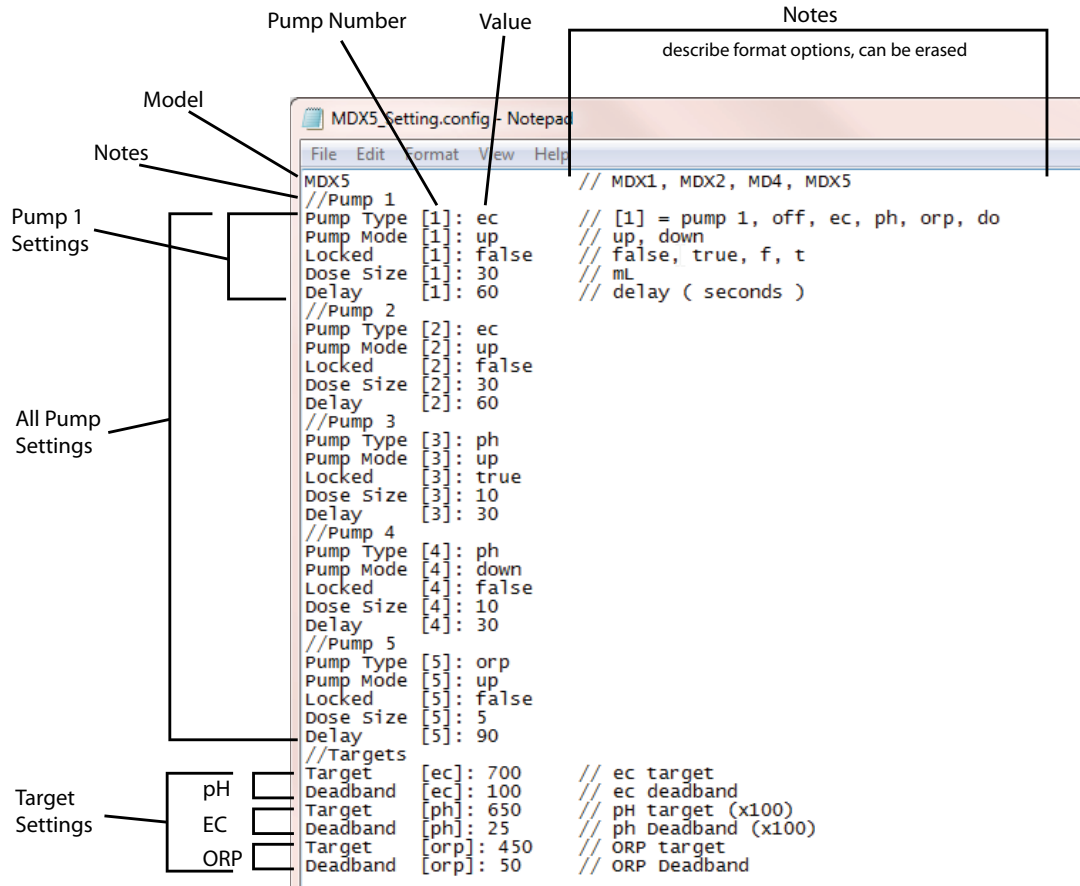

To upload the file to the controller, connect the SXH controller to the USB AgrowLINK (disconnect the pump.)

Change the COMM mode to "NORMAL" (Menu > Setup > Next > Comm) then upload the file.

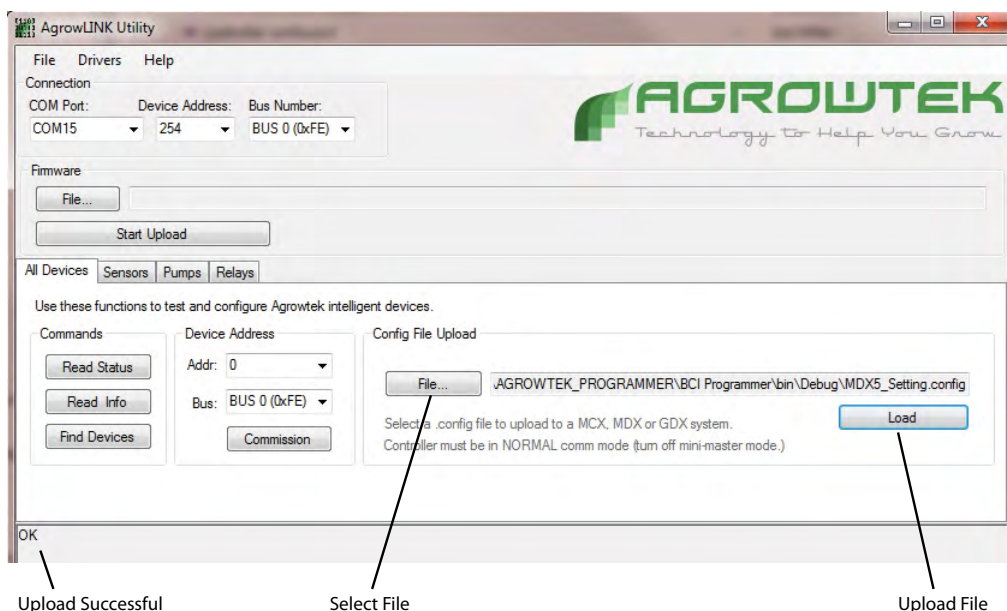

Return the controller COMM mode to "MINI MASTER" and re-connect the pump.

Maintenance

Exterior Cleaning

Exterior may be wiped with a damp cloth with mild dish detergent, then wiped dry.

Pumps

Pump heads are replaceable when the tubing wears out from extended use. Pump heads typically last 12-24 months depending on the volumes being dispensed. Replacement is a simple process of rotating the pump head counter-clockwise 1/8 turn and sliding the head off of the motor shaft. Replace in reverse order.

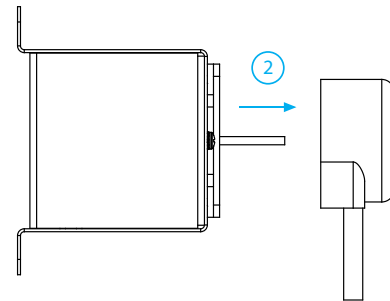
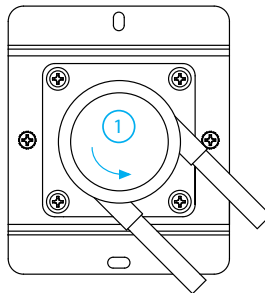

Probe Cleaning

Coating of the pH or ORP bulbs can lead to erroneous readings including shortened span (slope). Coatings and blockages in the EC sensor can cause incorrect readings. The type of coating will determine the cleaning technique.

Soft coatings can be removed by vigorous stirring or by the use of a squirt bottle.

Organic chemical or hard coatings should be chemically removed. 5-10% hydrochloric acid (HCl) soak for a few minutes and often removes many coatings.

If cleaning does not restore pH sensor performance, reconditioning may be tried.

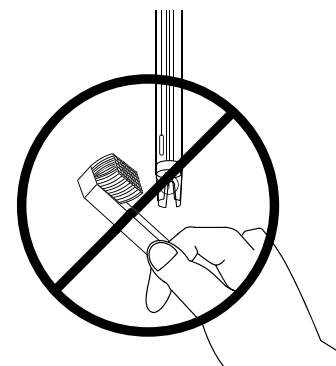

Do not use a brush or abrasive on pH or EC probes.

pH Probe Reconditioning

When reconditioning is required due to electrode aging the following chemical treatments can be tried. They are presented in the order of the severity of attack on the pH glass and may not improve (and in some cases actually further deteriorate) electrode performance.

⚠ DANGER: Use proper precautions when handling these hazardous chemicals. Ammonium bifluoride and HF (hydrofluoric acid) are extremely hazardous and should only be used by qualified personnel.

Reconditioning Method 1

Immerse the electrode tip in 0.1 N HCl for 15 seconds, rinse in tap water and then immerse tip in 0.1 M NaOH for 15 seconds and rinse in tap water. Repeat this sequence three times and then recheck the electrode's performance. If performance has not been restored, try method two.

Reconditioning Method 2

Immerse the tip in a 20% solution of NH₄F-HF (ammonium bifluoride) for two to three minutes, rinse in tap water and recheck performance. If performance has not been restored, try method three.

Reconditioning Method 3

Immerse electrode tip in 5% HF for 10-15 seconds, rinse well in tap water, quickly rinse in 5N HCl, rinse well in tap water and recheck performance. If performance has not been restored, it is time to get a new probe.

Technical Information

Specifications

Sensor

Power	12-24Vdc, ~2W (5W w/LCD)
Max Cable Distance	1000ft
Optional Interface	LCD w/3 Buttons
Temperature Range	-20 - 60°C
Temperature Accuracy	±2°C, 0.01° resolution
pH Range	0-14pH
pH Accuracy	±0.02pH, 0.01pH resolution
Conductivity Range	0 - 5000 uS (0-2500ppm)
Conductivity Accuracy	±20uS, 2uS resolution
ORP (DO) Range	-1000 - +1000mV (0-20mg/L)
ORP (DO) Accuracy	±10mV, 1mV resolution (±0.1mg/L, 0.1 resolution)
4-20mA Output Resolution	12 bit , 0.005mA

Pump

Power	12Vdc, 1Amp
Pump Heads	Single/Dual/Quad
Flow Rate	Variable, 15-50mL/min
Tubing Material	FDA Approved Norprene
Tubing Size	1/4" O.D. x 3/16" I.D.
Max Outlet Pressure	20psi
Minimum Dose Size	1mL

Storage and Disposal

Storage

Store equipment in a clean, dry environment with ambient temperature between 10-50°C.

Disposal

This industrial control equipment may contain traces of lead or other metals and environmental contaminants and must not be discarded as unsorted municipal waste, but must be collected separately for the purpose of treatment, recovery and environmentally sound disposal. Wash hands after handling internal components or PCB's.

Warranty

Agrowtek Inc. warrants that all manufactured products are, to the best of its knowledge, free of defective material and workmanship and warrants this product for 1 year from the date of purchase. This warranty is extended to the original purchaser from the date of receipt. This warranty does not cover damages from abuse, accidental breakage, or units that have been modified, altered, or installed in a manner other than that which is specified in the installation instructions. Agrowtek Inc. must be contacted prior to return shipment for a return authorization. No returns will be accepted without a return authorization. This warranty is applicable only to products that have been properly stored, installed, and maintained per the installation and operation manual and used for their intended purpose. This limited warranty does not cover products installed in or operated under unusual conditions or environments including, but not limited to, high humidity or high temperature conditions. The products which have been claimed and comply with the aforementioned restrictions shall be replaced or repaired at the sole discretion of the Agrowtek Inc. at no charge. This warranty is provided in lieu of all other warranty provisions, express or implied. It is including but not limited to any implied warranty of fitness or merchantability for a particular purpose and is limited to the Warranty Period. In no event or circumstance shall Agrowtek Inc. be liable to any third party or the claimant for damages in excess of the price paid for the product, or for any loss of use, inconvenience, commercial loss, loss of time, lost profits or savings or any other incidental, consequential or special damages arising out of the use of, or inability to use, the product. This disclaimer is made to the fullest extent allowed by law or regulation and is specifically made to specify that the liability of Agrowtek Inc. under this limited warranty, or any claimed extension thereof, shall be to replace or repair the Product or refund the price paid for the Product.