

INSTRUCTION MANUAL

HASH

CONTROLLER APP



**HASH
APP**
Basics

Attaching/controlling a
**LIGHTING-HASH
CONTROLLER**

Attaching/Controlling "non-wireless"
equipment using **RELAY POWER CORD**

Attaching an
**ENVIRONMENT
SENSOR**

Using the **DESKTOP**
and **DEVICES** tabs

Setting up **RULES** to automate your garden

Using the **JOURNAL** to
track development.

Spec
sheets

HASH 
CONTROLLER APP

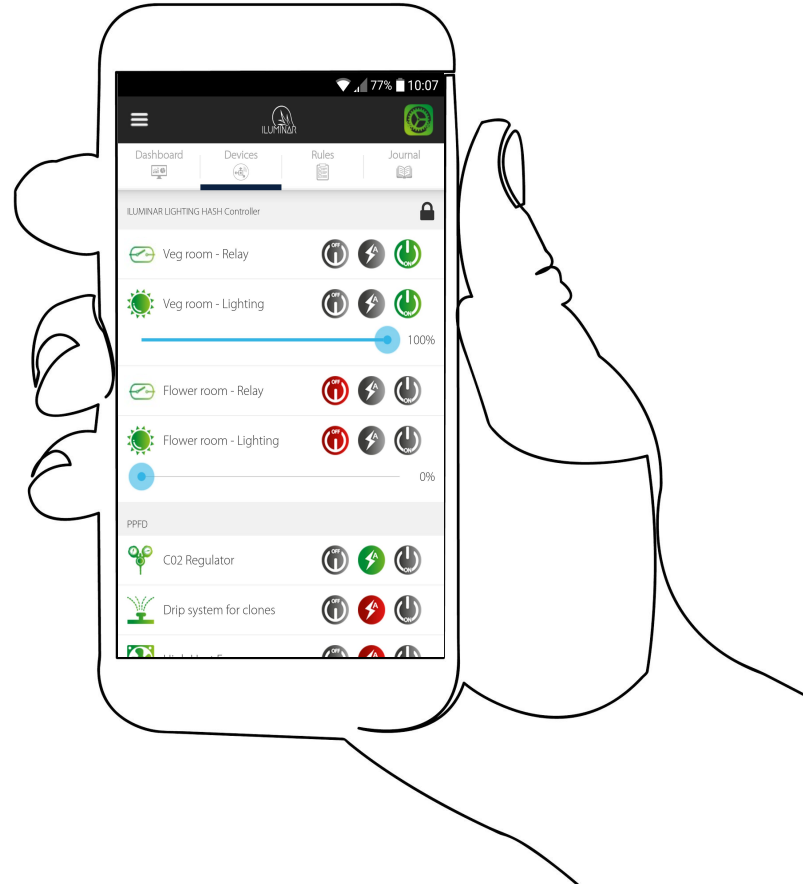



HASH

ECOSYSTEM



The HASH Ecosystem app

- Wirelessly monitor & control the entire HASH ECOSYSTEM from your smart device.
- Control UNLIMITED LIGHTING HASH Controllers from a single app.

LIGHTING-HASH CONTROLLER (LHC)

- 2 Channel Control Available (up to 500 fixtures per channel) & 2 x 0-48V Relays.
- Rugged Design allows for years of use without calibration.
- Add up to SIX wireless modules (Sensors or RELAY POWER Cords) in seconds.
- Control HPS, MH, CMH, T5 and LED fixtures all one channel*
- Connect to ARGUS or PRIVA in Seconds
- Light controller dimming options: 0-10V, 1-10V, 5-10V, 0-11.5V.



ENVIRONMENT SENSOR (ES)

- Link to an unlimited amount of Environmental Sensors.
- Monitor and Control VPD, PAR, TEMP, Humidity, Co2.
- Sensors can be used to trigger corrective actions automatically.
- Analyze & view real-time data logging information right on your smart device.



RELAY POWER CORD (RPC)

- Wirelessly turn a device on or off with the ILUMINAR HASH Controller.
- Use the ILUMINAR mobile app to create rule triggers, schedules, timers, remote control, and access data analytics.

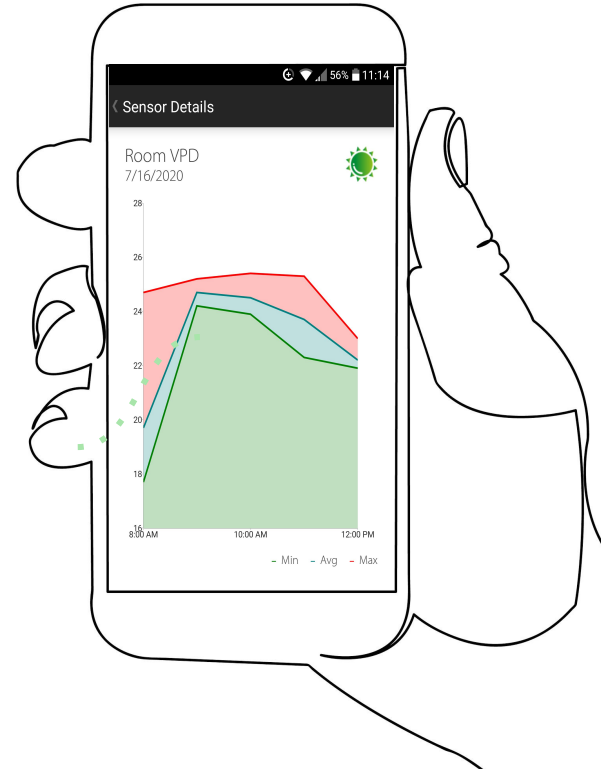



HASH

CONTROLLER APP



Horticulture Automated Systems Hub

The full HASH enabled range of garden control products consists of:

The **LIGHTING-HASH CONTROLLER** (LHC) unit, the **HASH ENVIRONMENT SENSOR** (ES) and the **HASH RELAY POWER CORD** (RPC) which are all wirelessly controlled through the HASH app which is available on the Apple and Android stores or via the [ILUMINAR website](#).

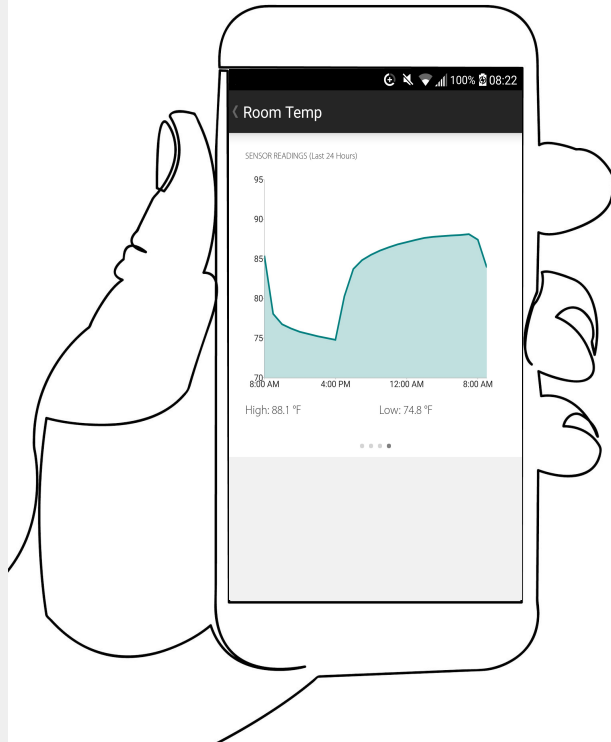

Installing the app

Install the app from the Apple iOS or Android stores and start it up on your device.



HASH

ECOSYSTEM



Create a HASH account

Once the app is installed on your device, you must create a user account in order to activate the **HASH Ecosystem**. Simply select **“create account”** and fill in the details following the on-screen instructions to assign a password and confirm your email account.

Complete details . . .

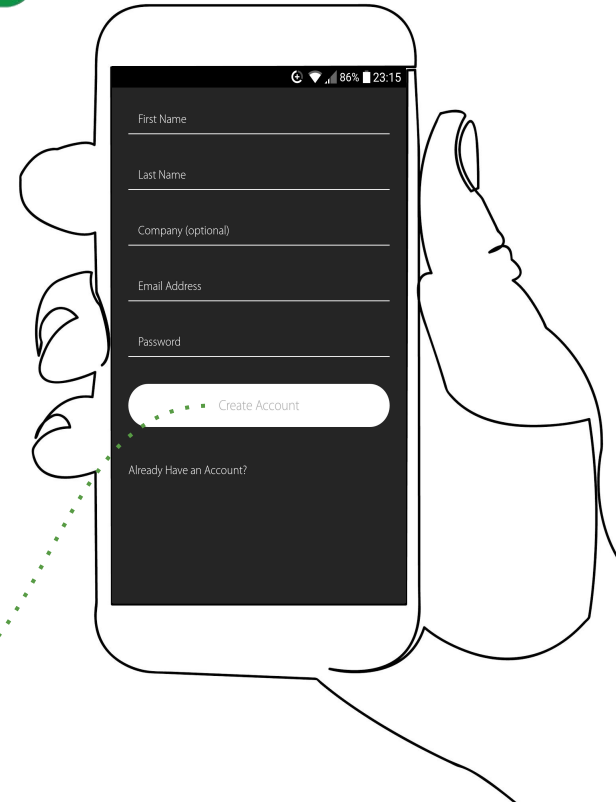
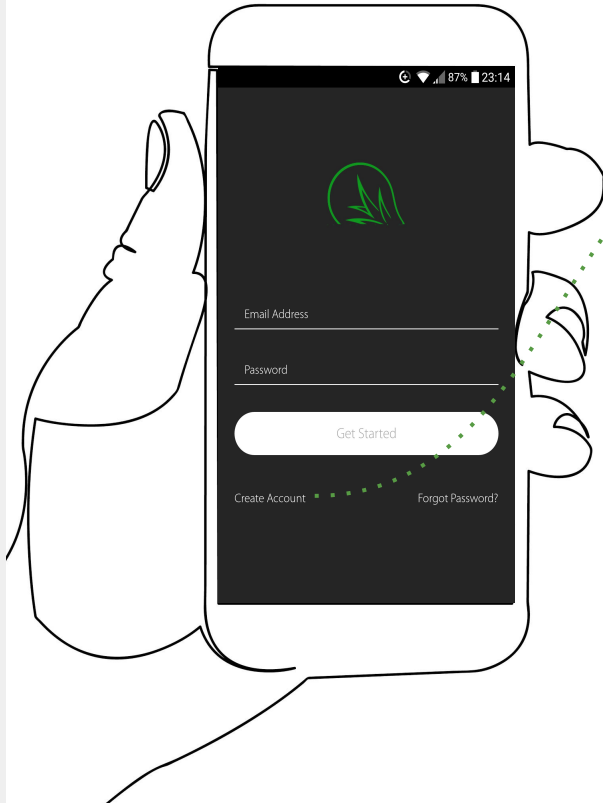



HASH

CONTROLLER APP



Accessing the app

Log in to your **HASH Account** by entering your email and password in the provided boxes, this will lead you to the **MAIN SCREEN**.

The **HASH app** has been designed to remain active at all times, but should you wish to **LOG-OUT** of the app, you can do so via the **SETTINGS** menu from the **MAIN SCREEN**.

Settings Menu

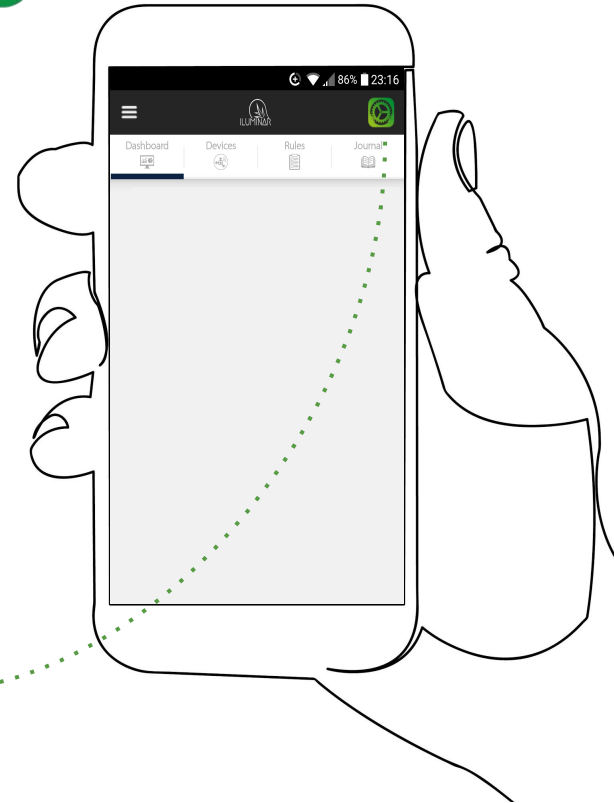
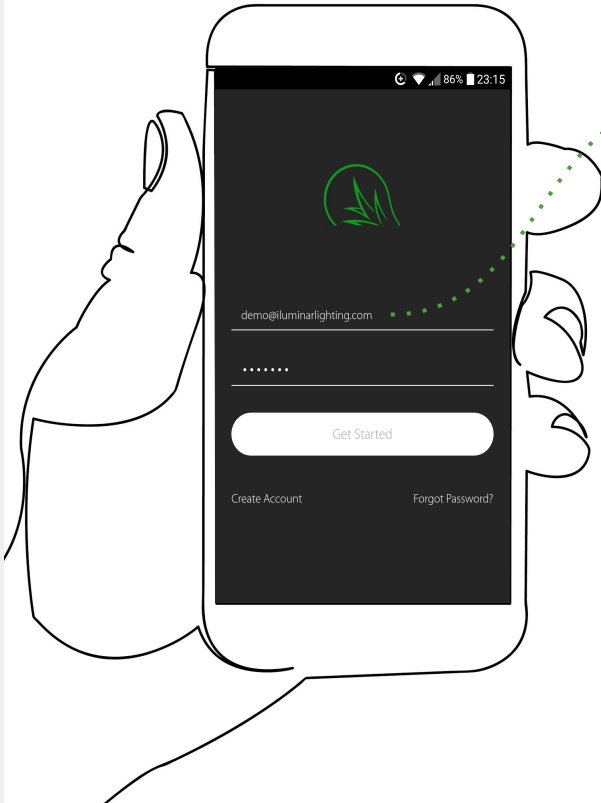

HASH

CONTROLLER APP



NAVIGATION

The main screen has six selectable options; top left is the **CONTROLLER MENU**, top right is the **SETTINGS MENU** and underneath them are the **DASHBOARD**, **DEVICES**, **RULES** and **JOURNAL** tabs.

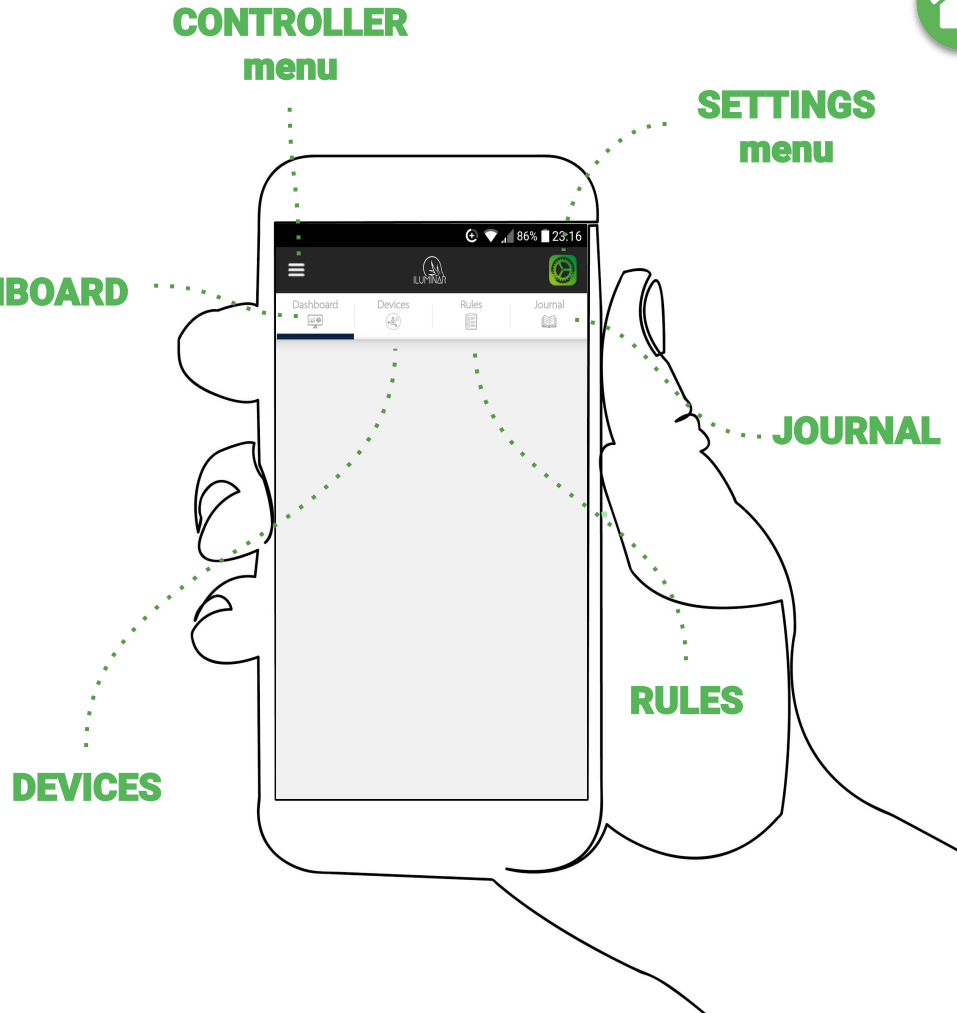

HASH

ECOSYSTEM

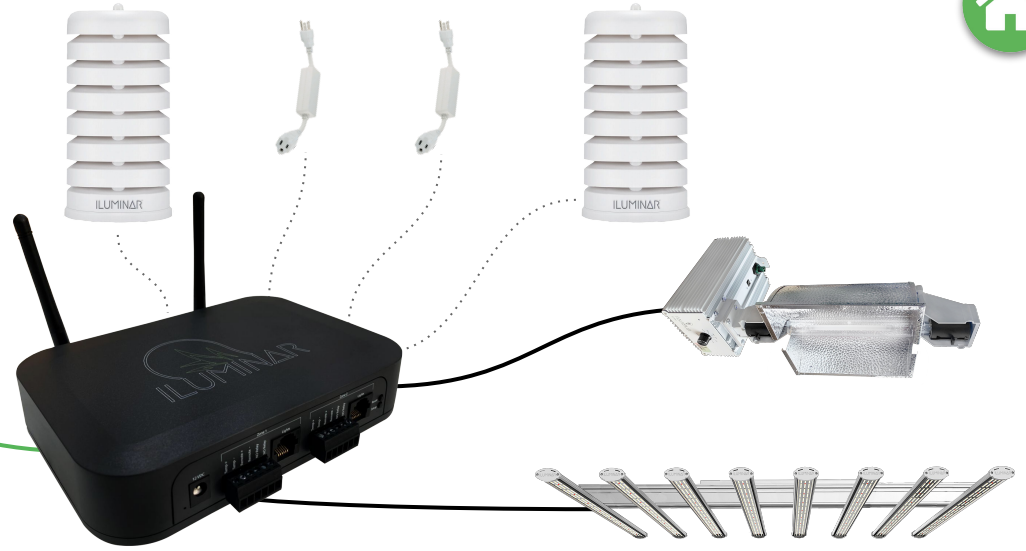

HUMIDITY · HVAC · VPD · PAR · CO₂ · LIGHTING · TEMP

Add a **LIGHTING-HASH CONTROLLER**

The first step to automating your garden is to connect your **LIGHTING-HASH CONTROLLER** unit(s).

The **HASH Ecosystem** allows for **unlimited controllers** to be attached and managed by the same app.

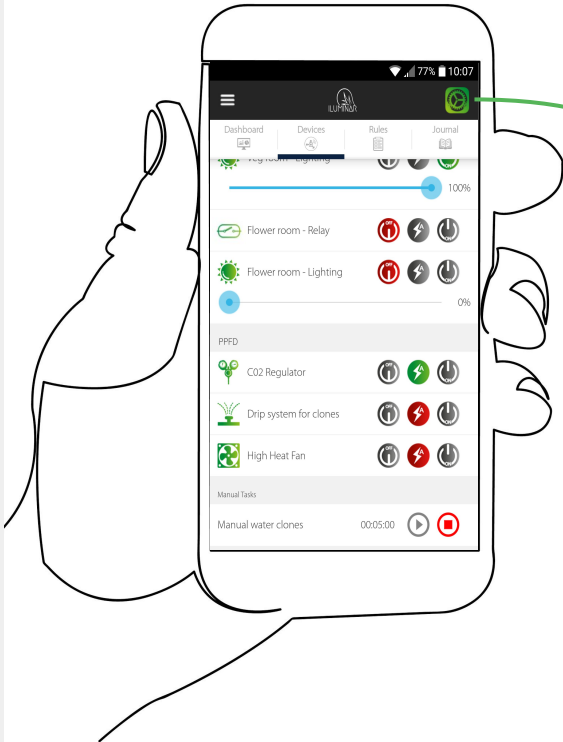

HASH

CONTROLLER APP



Connecting: LIGHTING-HASH CONTROLLERS (LHC)

Unbox and set-up the controller in its location as per **LHC instructions**, connecting it to the internet and remembering to pay attention to the notes on **RF interference***. Once the unit is set up with the power switched on, it's ready to be connected to the **HASH app**.

*Metal structures can block wireless RF communication signals. If using the RELAY POWER CORD, HASH LIGHTING CONTROLLER or ENVIRONMENT SENSOR inside a metal structure, make sure the HASH CONTROLLER is also inside the same metal structure. The RF range can reach up to 1100 meters if a direct line-of-sight between the RELAY POWER CORD and the HASH CONTROLLER is established. In a dense industrial greenhouse environment full of equipment, shelving, plants, etc. with no line-of-sight, the RF range is typically closer to 50-100 meters.

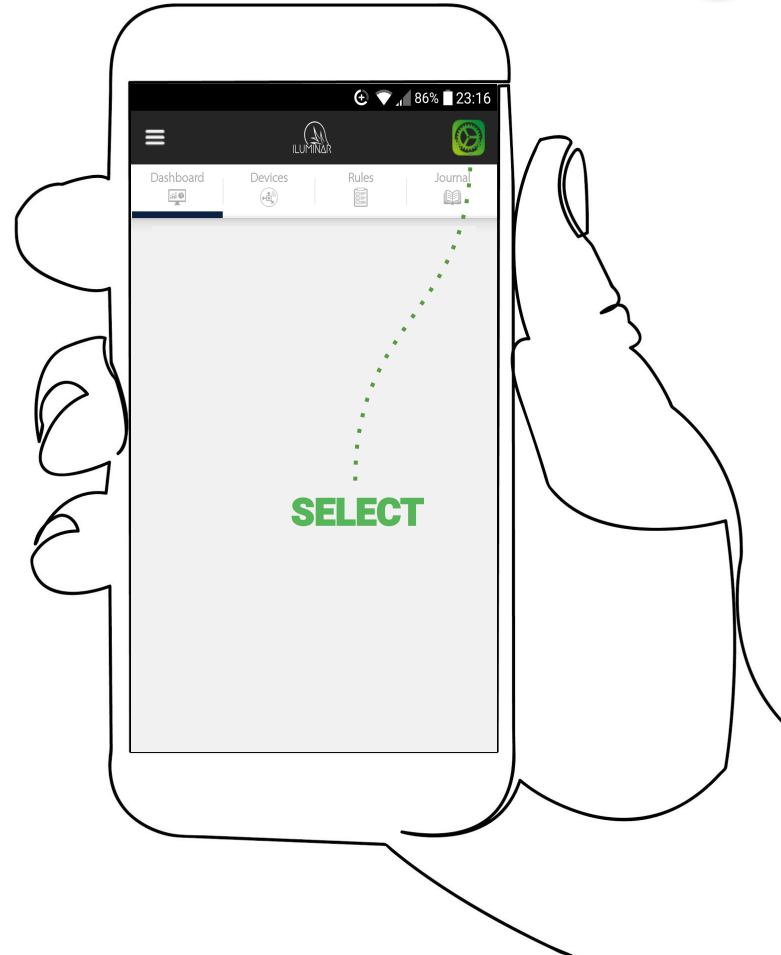



Connecting CONTROLLER(s)

Look for the **Blue button** on the side of the controller and **press it for 1 second** activating the bluetooth connectivity. On the **HASH app**, select the **SETTINGS** menu at the top right, then select **CONNECT TO CONTROLLER**.

The **HASH app** should discover the **LIGHTING-HASH CONTROLLER** if it's within **communications distance*** inside a few seconds. **If you can't connect, retry the previous steps**, but if that fails, you may need to **rethink the unit's location** due to distance or signal interference.

To add multiple units simply repeat the connection process for each as per the above instructions.

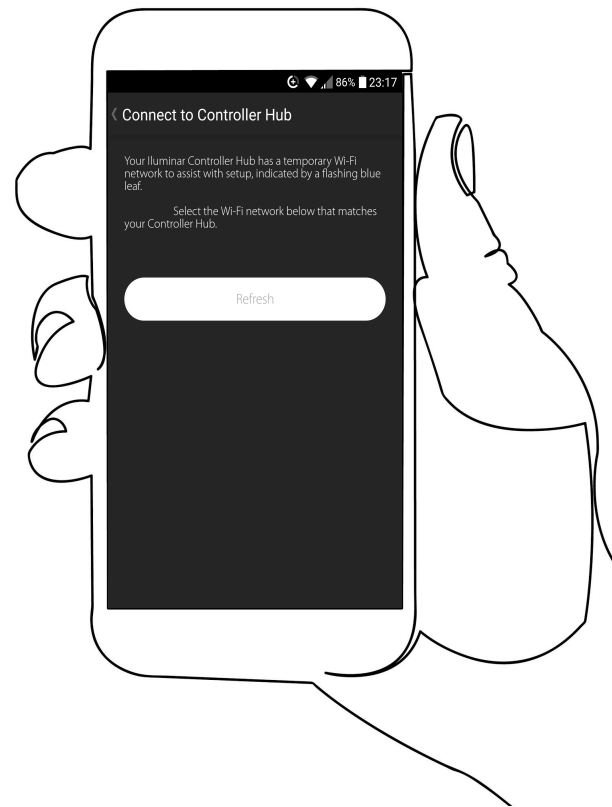
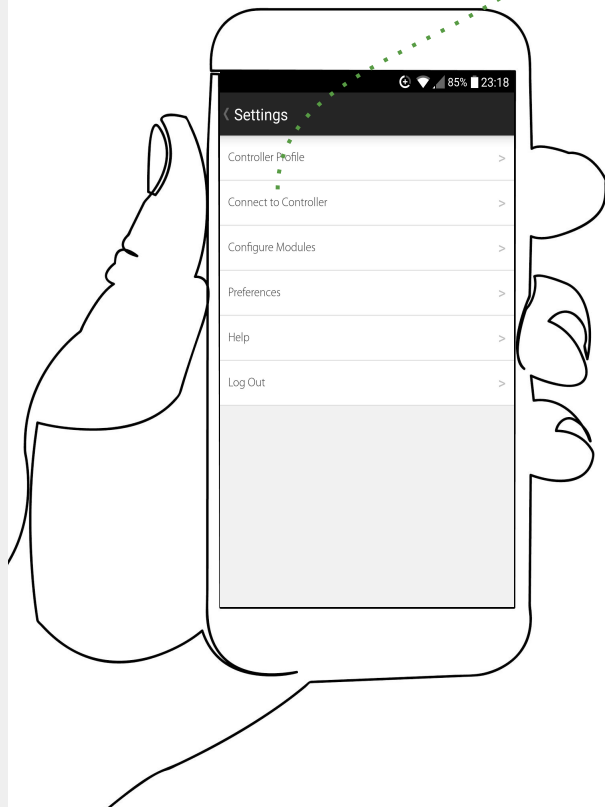



HASH

CONTROLLER APP



Switching between multiple LIGHTING-HASH CONTROLLERS (LTC)



After connecting one or more unit/s, each should now be visible on the **CONTROLLER MENU** at the top left of the **MAIN SCREEN**.

On the **CONTROLLER MENU** you can now toggle between the attached **HASH CONTROLLER** units visible on the menu, to view the status or use one of them simply select it from the list and the **MAIN SCREEN** will switch to that units data stream.



Configuring: LIGHTING-HASH CONTROLLERS (LHC)

Once the **MAIN SCREEN, DASHBOARD** tab is showing data from the desired **LIGHTING-HASH CONTROLLER** you can now **update the unit's profile, modify its name, basic settings** and attach equipment **MODULES** for it to control. Select the **SETTINGS MENU** from the **MAIN SCREEN** and then select **CONTROLLER PROFILE** to open **MODULE DETAILS**.

From the MODULE DETAILS screen you can:

- Change the **CONTROLLER NAME**
- Control the **COUNTRY** the garden is in by selecting it from the list (vital for data calibration)
- Control the **TIME ZONE** the unit is in (vital for **SCHEDULING/RULES**)
- Set a controller **SHUTDOWN TEMPERATURE**
- Toggle the **ANALOG INPUT OVERRIDE** on or off

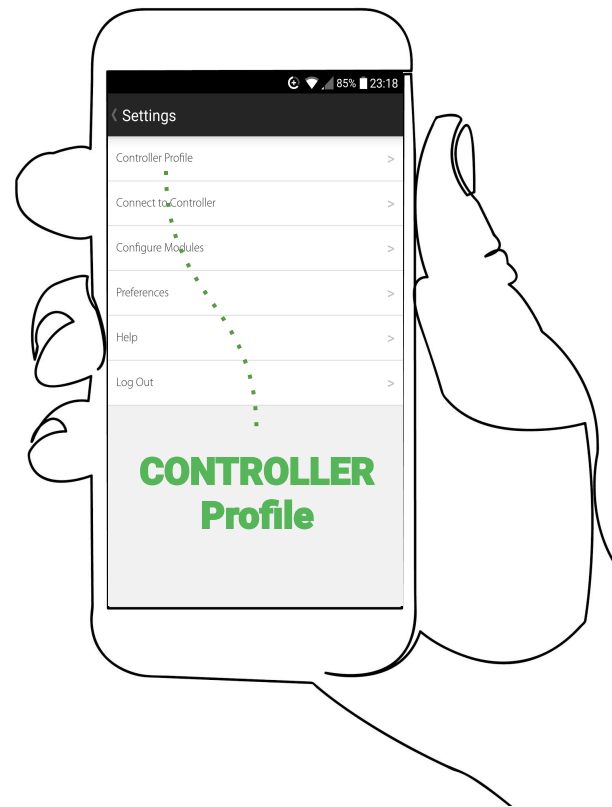
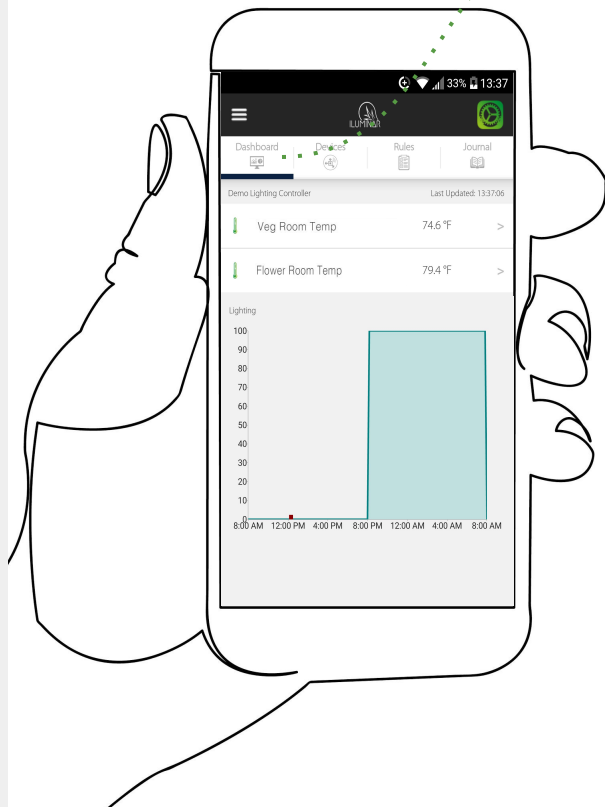



Configuring: LIGHTING-HASH CONTROLLERS (LHC)

Each LIGHTING-HASH CONTROLLER has TWO DEDICATED 0-48V RELAY SWITCHES (one per ZONE) that enable powered equipment to be hard wired into the LIGHTING-HASH CONTROLLER and controlled remotely controlled via the HASH App & ECOSYSTEM.

Dedicated RELAY CIRCUITS

Dimming controls for ANY type of light source: LED, HPS, CMH, FL.

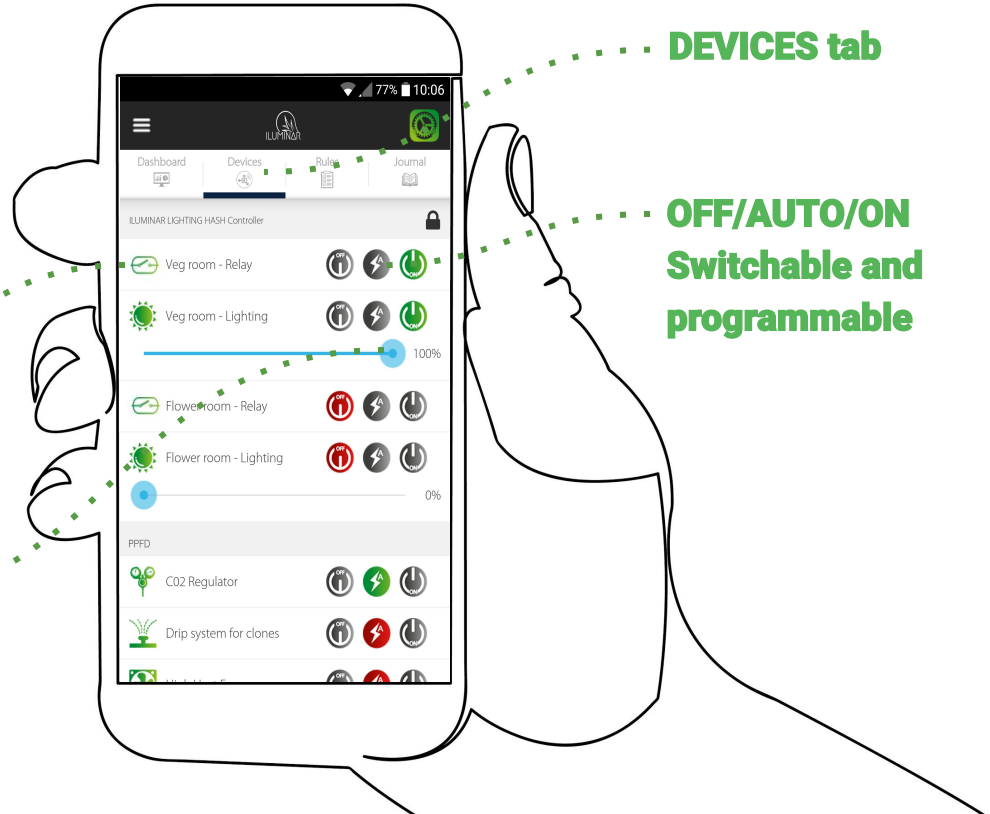



Configuring: LIGHTING-HASH CONTROLLERS (LHC)

The LIGHTING HASH CONTROLLER can run and dim LED/HPS/CMH/FL.

1) Navigate to LHC MODULE DETAILS

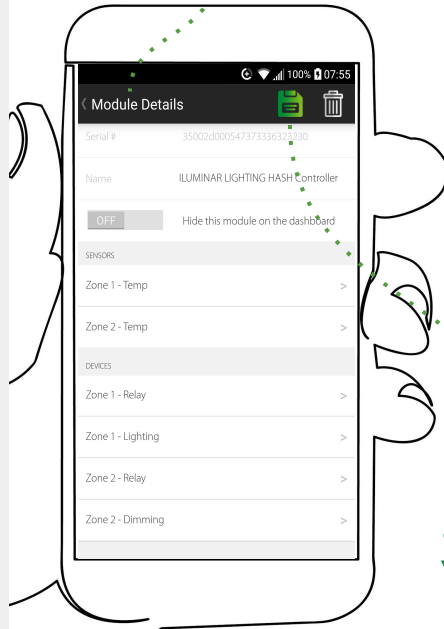

2) Select Technology (of lighting)

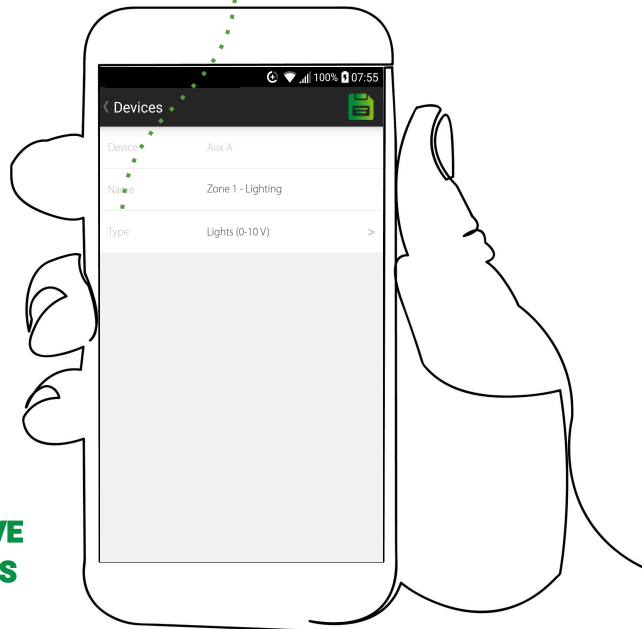

3) Select corresponding Dim Protocol

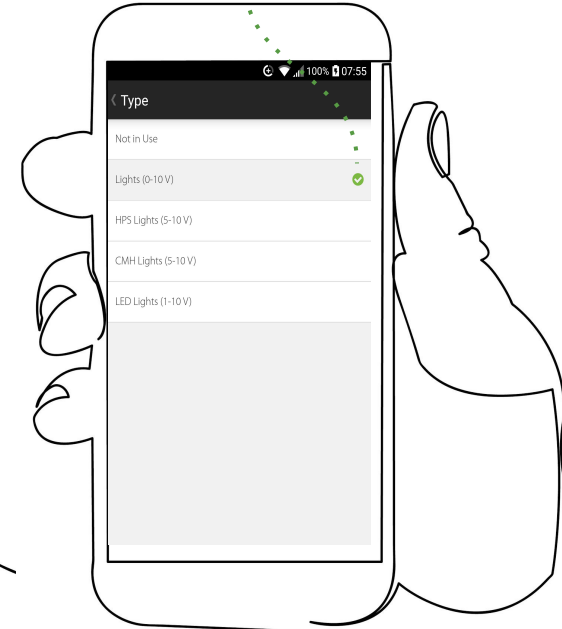

4) ALWAYS SAVE YOUR SETTINGS



Adding other equipment **MODULES (RPC/ES)**

MODULES control the equipment in your garden. To attach a piece of equipment/**MODULE**, from the **MAIN SCREEN**, select the **SETTINGS MENU**, from there select **CONFIGURE MODULE**. Any **MODULES** already connected to the system will be listed on the following **MODULES** screen.

To add a new **MODULE** click the **+** symbol at the top right corner and the app will search for the new equipment. If any compatible equipment is found the **REGISTER MODULES MENU** will open. If not try moving closer and refresh the page with a swipe down.

Select the + to add MODULES

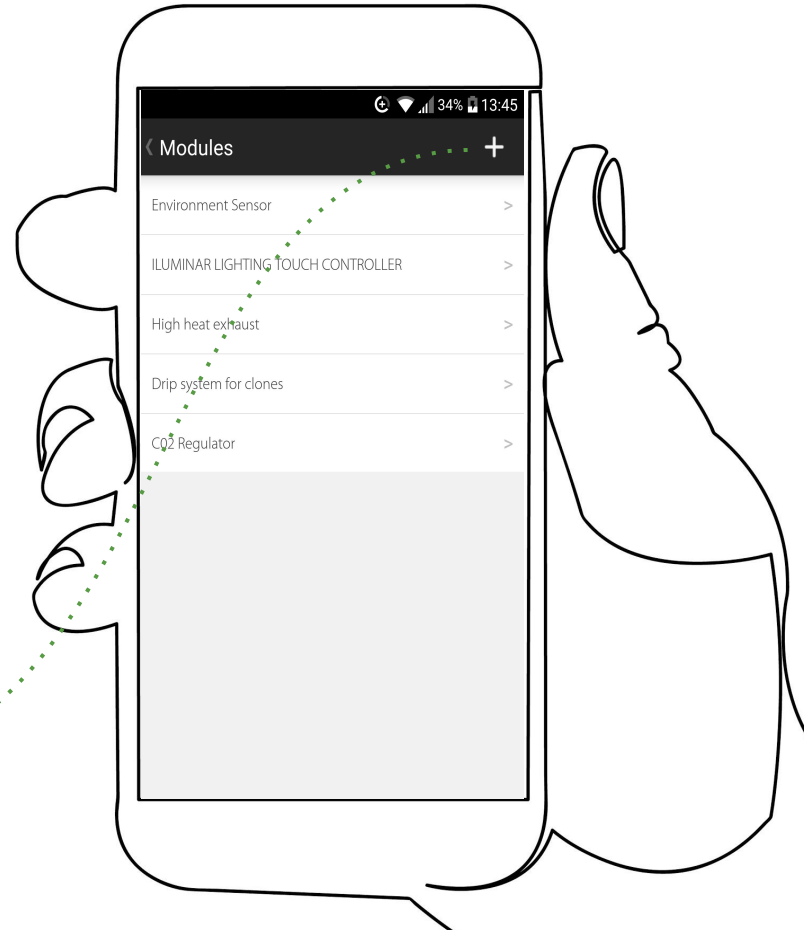



MANUAL CONNECTION

If the **HASH app** cannot find the equipment **MODULE** you're trying to attach, **follow this procedure.**

1) Select 4 SQUARES symbol

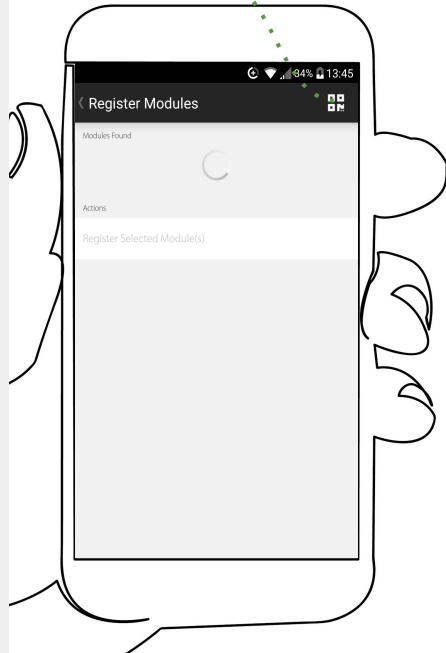

2) Scan the QR CODE on MODULE

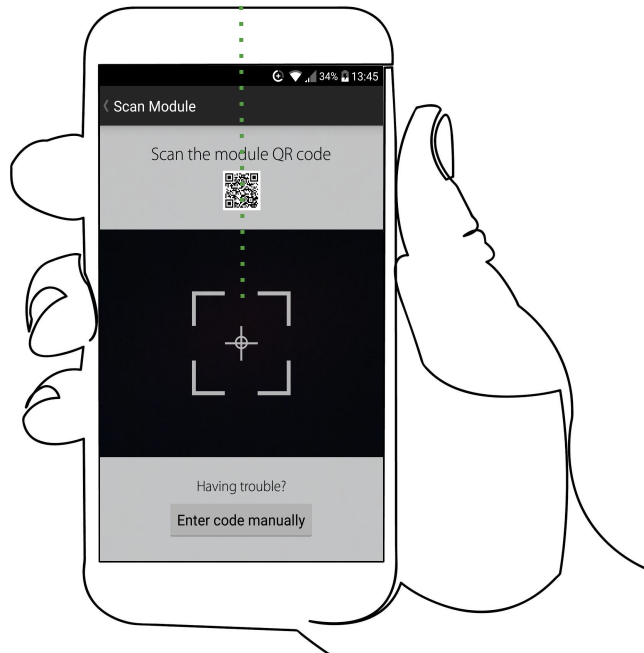

3) If QR not working type In the code

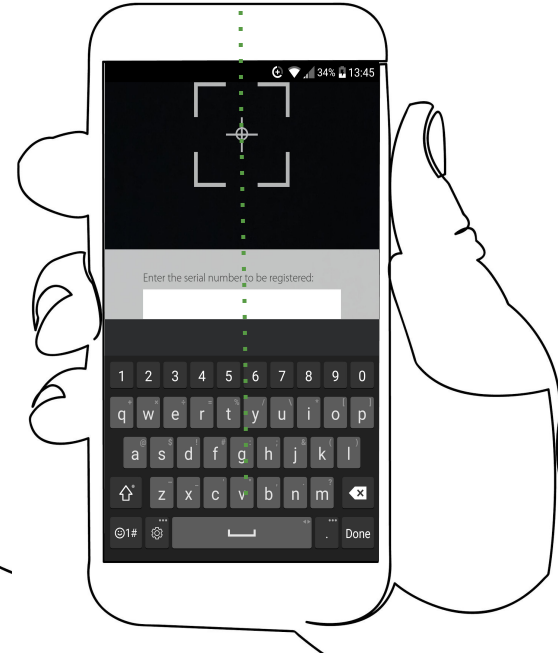



Registering: MODULES

Select the piece/s of equipment from the list by highlighting it/them with a **green check** and select **REGISTER SELECTED MODULE(S)**. Once the registration is complete (which may take a few moments depending on connection speed) the equipment will appear in the **MODULE DETAILS** screen, so you can name and classify it.

Create; MODULE NAME

Modify; Equipment TYPE

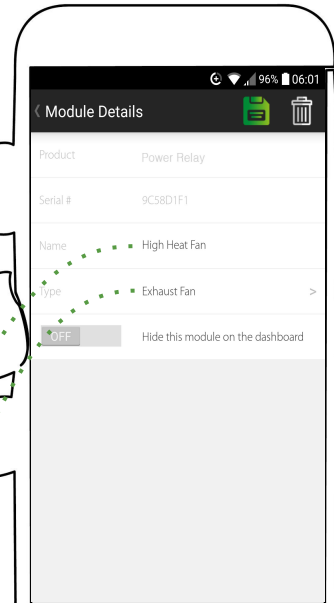
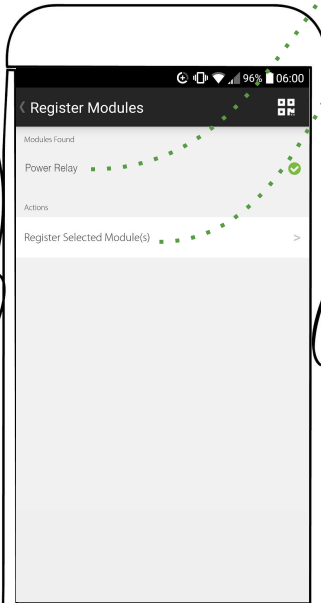



HASH

Environmental
SENSOR

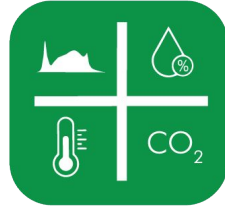

TEMP • HUMIDITY • VPD • PAR • CO₂

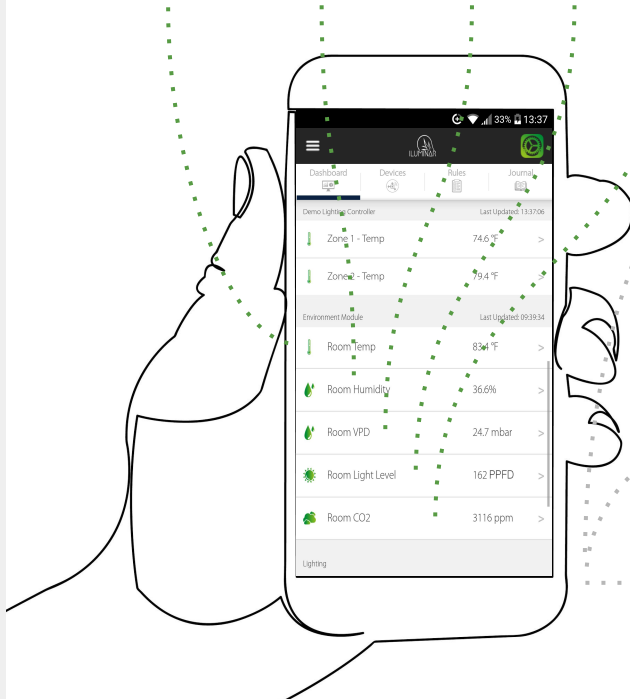

Environment	Devices	Tables	Journal
Demo Lighting Controller Last Updated: 13:37:06			
Zone 1 - Temp	74.6 °F	>	
Zone 2 - Temp	79.4 °F	>	
Environment Module Last Updated: 09:39:34			
Room Temp	83.4 °F	>	
Room Humidity	36.6%	>	
Room VPD	24.7 mbar	>	
Room Light Level	162 PPFD	>	
Room CO2	3116 ppm	>	
Lighting			



The ENVIRONMENT SENSOR (ES)

Add multiple ENVIRONMENT SENSORS

After connecting one or more unit/s, each should now be visible on the **CONTROLLER MENU** at the top left of the **MAIN SCREEN**. On the **CONTROLLER MENU** you can now toggle between the attached **HASH CONTROLLER** units visible on the menu, to view the status or use one of them simply select it from the list and the **MAIN SCREEN** will switch to that units data stream.





Configuring: ENVIRONMENT SENSOR (s)

Like all **MODULES**, **ENVIRONMENTAL SENSORS** can be customized with name changes and should more than one **SENSOR** be present on a **LIGHTING-HASH CONTROLLER** you can **AGGREGATE** (average) the reading across them.

Sensors can be calibrated easily whenever necessary on the ES' **MODULE DETAILS** Screen

**ALWAYS SAVE
YOUR CHANGES**

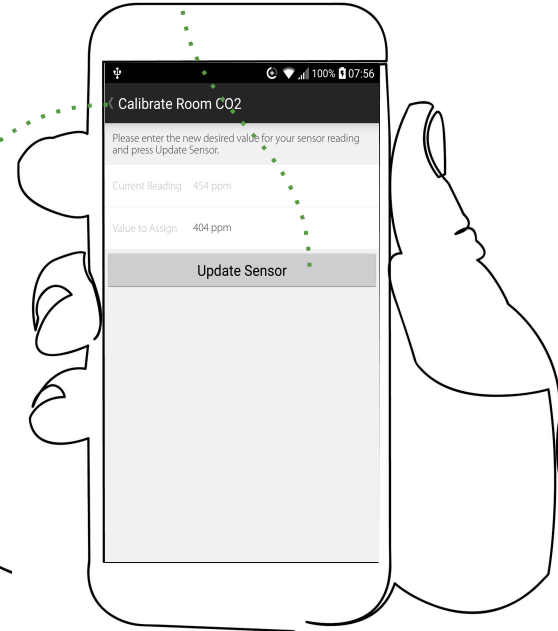
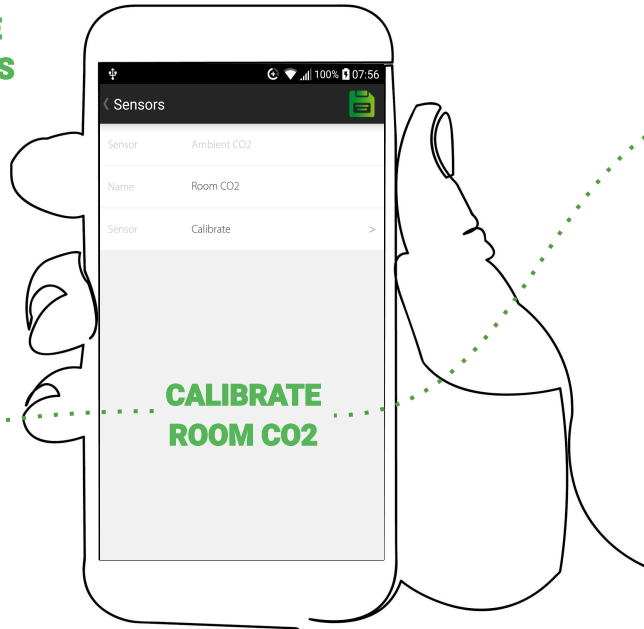
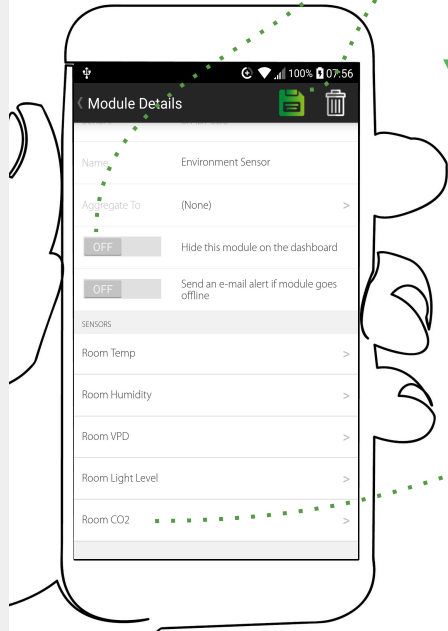



HASH

RELAY POWER
CORD



The RELAY POWER CORD (RPC)

Control almost anything with

Wireless RELAY POWER CORDS are basically wireless switches that can integrate all sorts of non-web connected equipment into the HASH Ecosystem. Available in 120/240V. 10 AMP MAX - 7 Amp Constant

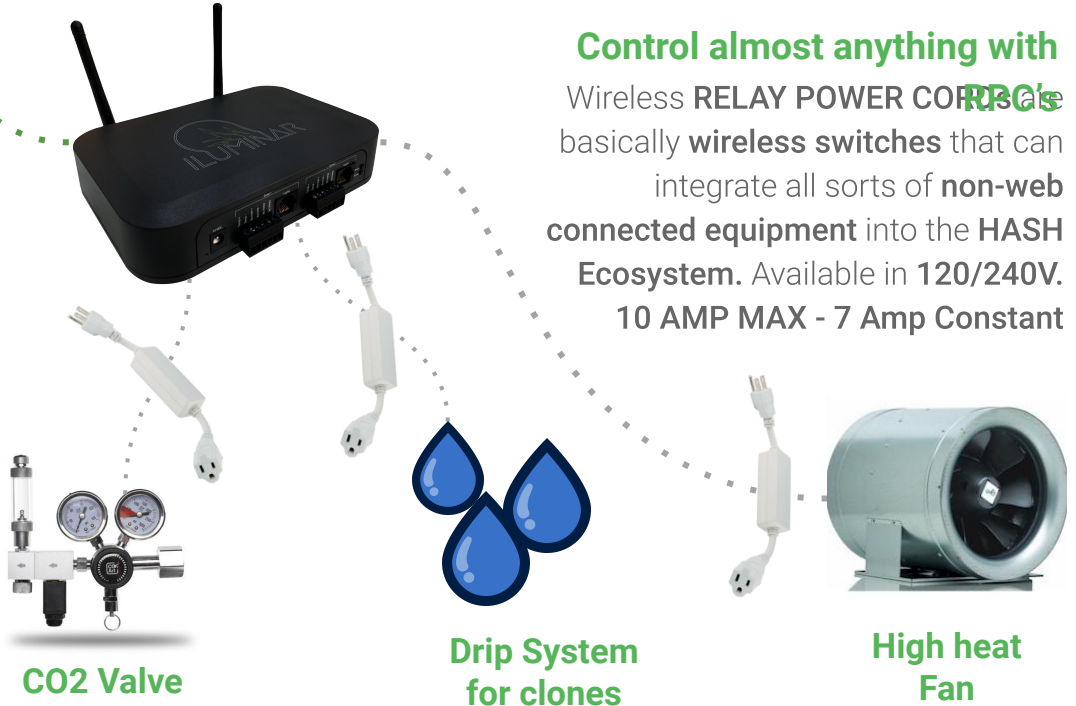
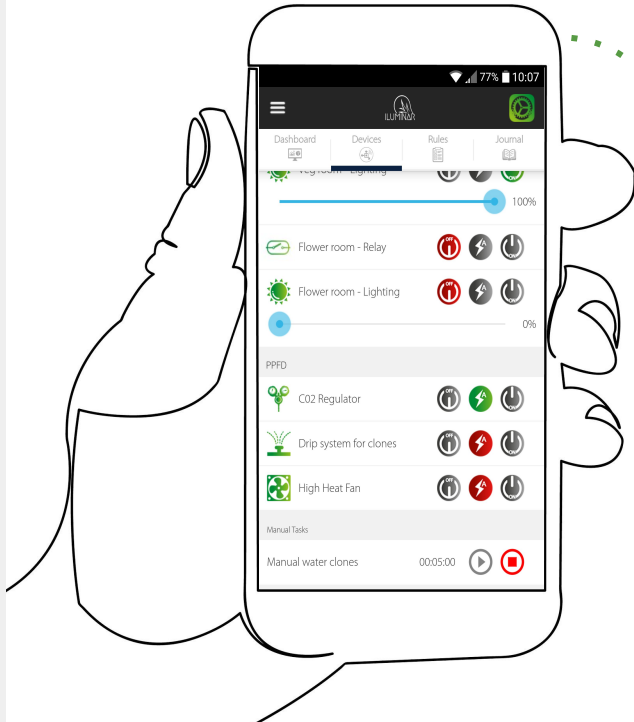

CO2 Valve

Drip System
for clones

High heat
Fan



The RELAY POWER CORD (RPC)



Drip Emitters

Air Conditioning

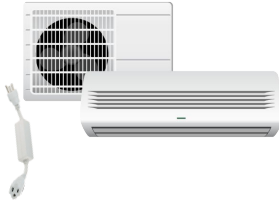

Hydroponics systems

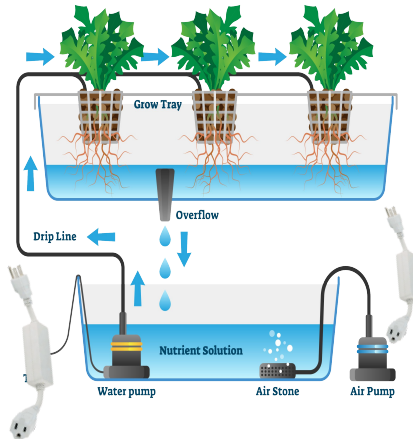

UV Supplemental lighting

CO2 Valve



Heating



Humidifier



Dehumidifier



High Temp Fan



The list of adaptable equipment is endless

Maximum of 6 wireless devices per LHC
Available in 120/240V - 10 AMP MAX - 7 Amp Constant



Configuring: The RELAY POWER CORD (RPC)

RELAY POWER CORDS like other MODULES can have customizable names and other factors depending on TYPE of equipment being enabled but all can be remotely switched, set to timers and/or set to any scheduling rules like the other modules.

RELAY POWER CORD
Drip emitter system

RELAY POWER CORD
CO2 Regulator

RELAY POWER CORD
High Heat Fan

1) Rename module
from default

2) Select equipment
Type from the list

3) Now you can
automate your garden!

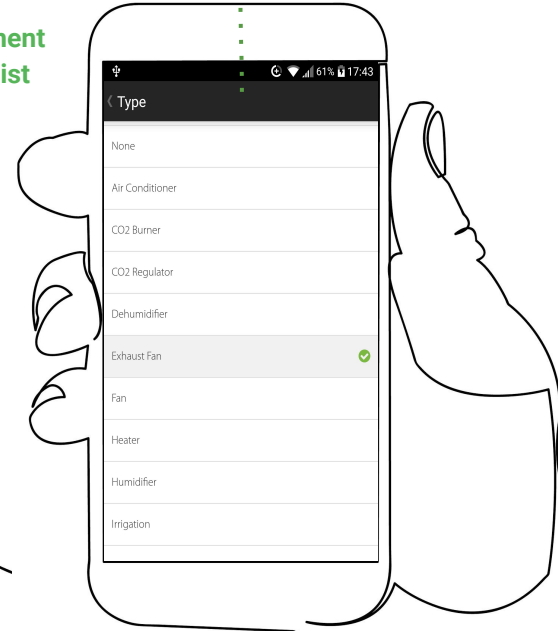
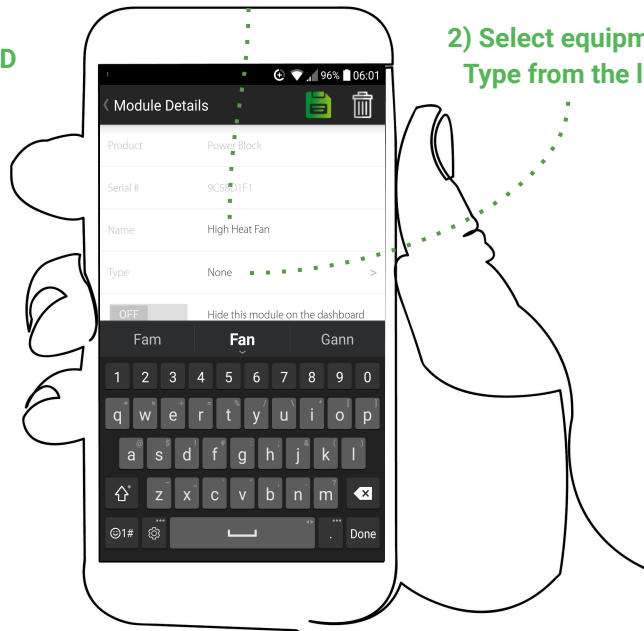
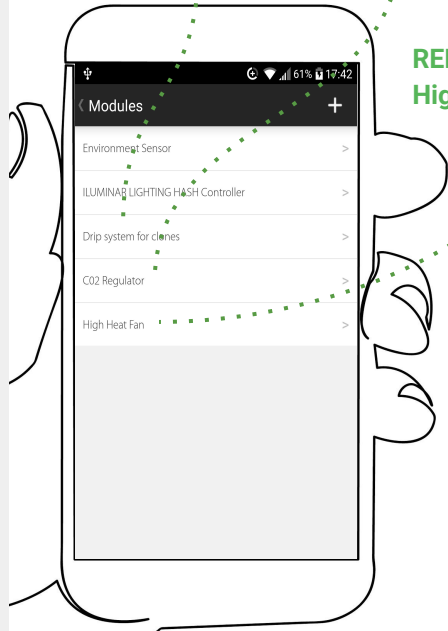



DASHBOARD

The two main operational screens are the **DASHBOARD** and **DEVICES** tabs from the **MAIN SCREEN**. The **DASHBOARD** displays real time and historical data whereas the **DEVICES** tab accesses a range of **simple controls** that enable users unprecedented levels of monitoring, control and automation.

ALL ATTACHED DEVICES CAN BE CYCLED ON/AUTO/OFF

LHC Powered Lamps Dimmable

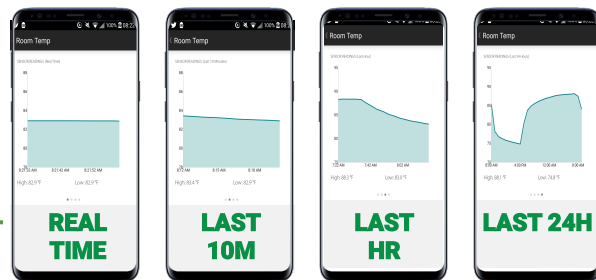

ALL DATA POINTS SWIPEABLE:

DEVICES

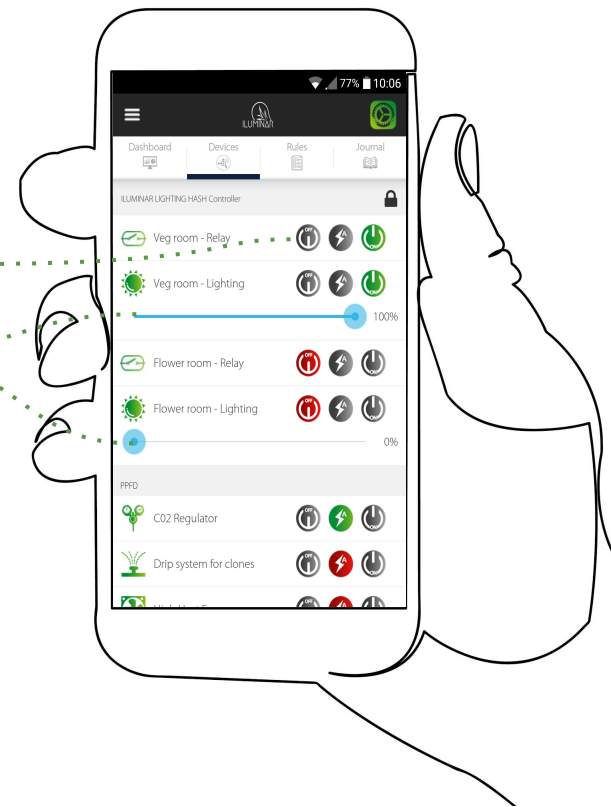



RULES, TRIGGERS, THRESHOLDS & TIMERS

Rules are instruction sets using sensors as **TRIGGERS & THRESHOLDS** allowing a complete **SCHEDULE** of automated activities to be programmed into the **HASH Ecosystem**.

TRIGGERS are switches that are tripped by a behavior, for **EXAMPLE: A heater triggered to run whenever the lamps are switched off** in order to stabilise the temperature during winter.

THRESHOLDS use **ENVIRONMENT SENSOR** data to perform an activity such as: **A CO2 regulator releasing gas determined by the reading from the sensor falling below a threshold of 1200 parts per million (PPM)**.

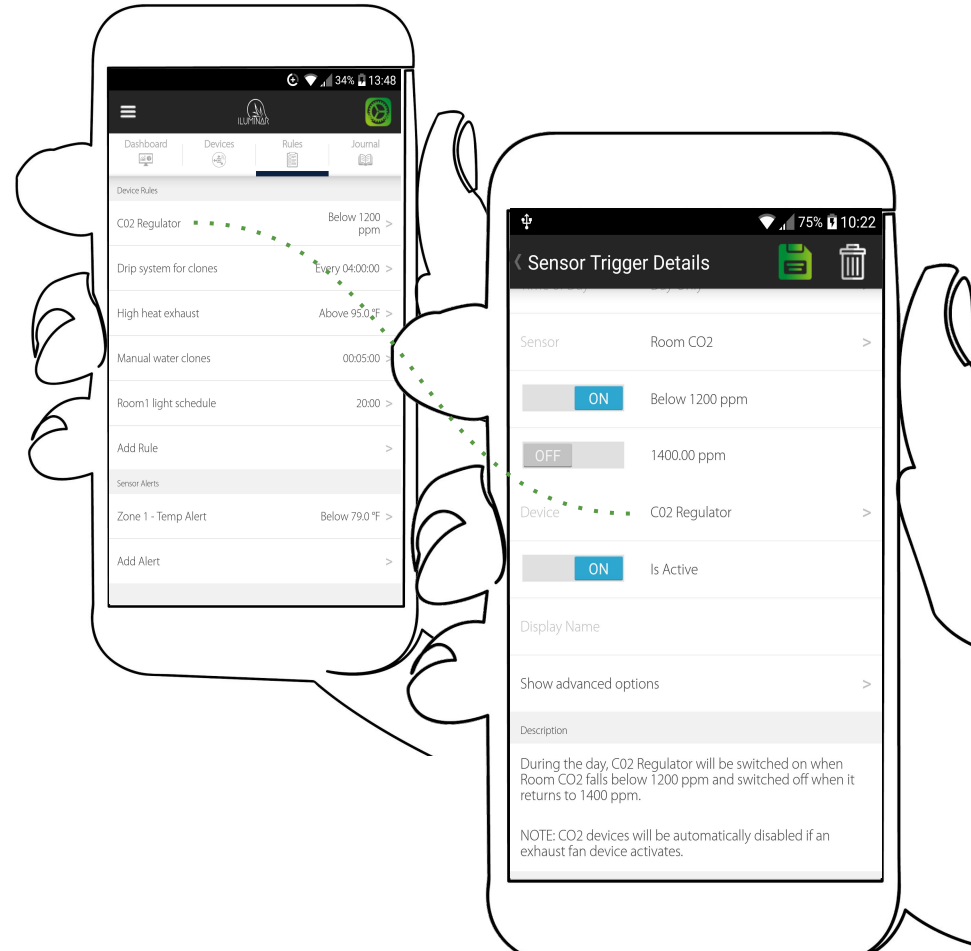



Creating rules: SENSOR TRIGGERS

TO CREATE A SENSOR TRIGGER go to the **RULES** tab on the **MAIN SCREEN** and select **ADD RULE** and then **SENSOR TRIGGERS**.

SELECT TIME OF DAY (ALL DAY/DAY ONLY/NIGHT ONLY/CUSTOM)

SELECT SENSOR TRIGGER

SELECT DESIRED THRESHOLD (OPTIONS DEPENDANT ON SENSOR) ie BELOW or ABOVE

WHAT DEVICE DO YOU WANT TO OPERATE?

GIVE IT A NAME

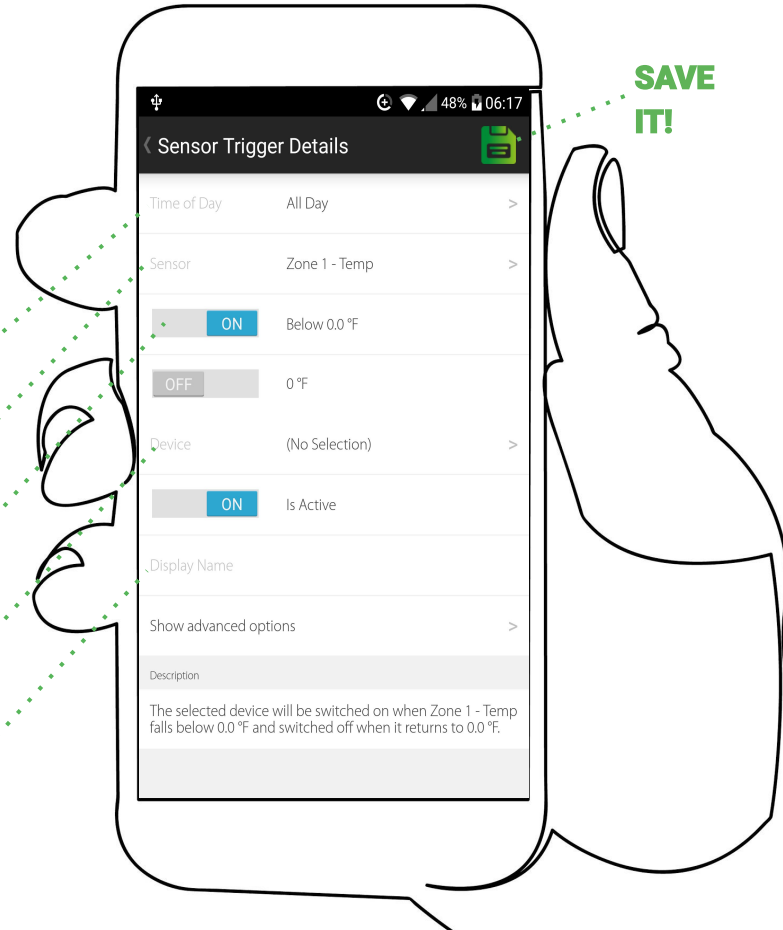

SAVE IT!

Sensor Trigger Details

Time of Day: All Day >

Sensor: Zone 1 - Temp >

ON Below 0.0 °F

OFF 0 °F

Device: (No Selection) >

ON Is Active

Display Name

Show advanced options >

Description

The selected device will be switched on when Zone 1 - Temp falls below 0.0 °F and switched off when it returns to 0.0 °F.



Creating rules: TIMERS

TO CREATE A TIMER TRIGGER go to the **RULES** tab on the **MAIN SCREEN** and select **ADD RULE** and then **SENSOR TRIGGERS**.

WHAT DEVICE DO YOU WANT TO OPERATE

**SELECT TIME OF DAY (ALL DAY/DAY ONLY/
NIGHT ONLY/CUSTOM)**

FREQUENCY OF OPERATION

DURATION OF OPERATION

GIVE IT A NAME

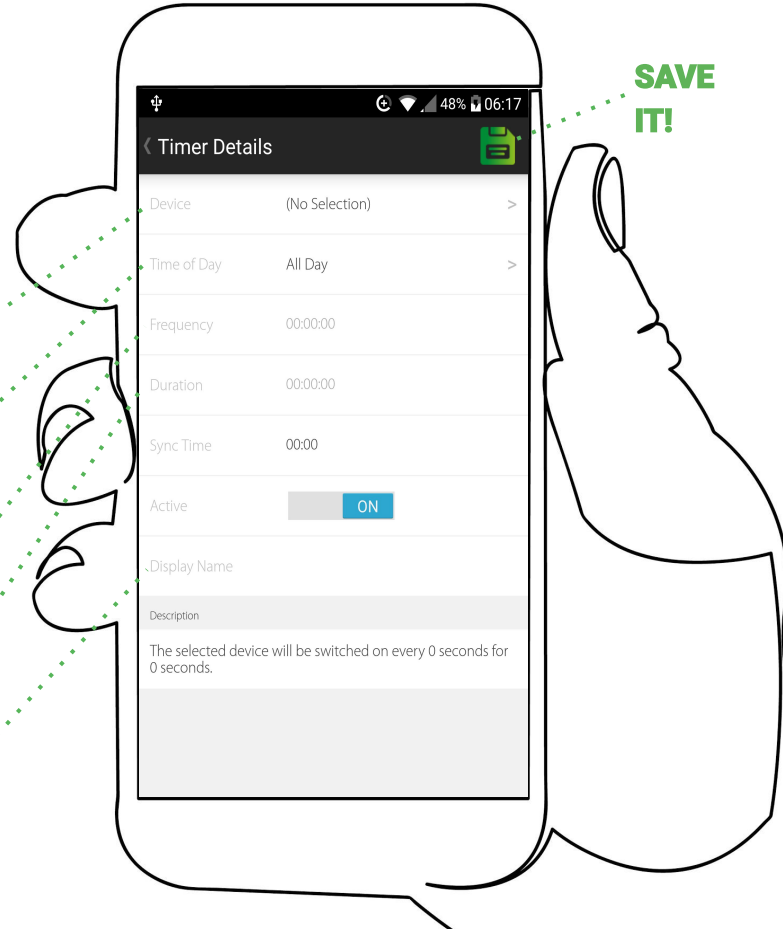

**SAVE
IT!**



Creating rules: SCHEDULES

TO CREATE A SCHEDULE TRIGGER go to the **RULES** tab on the **MAIN SCREEN** and select **ADD RULE** and then **SCHEDULE**.

WHAT DEVICE DO YOU WANT TO OPERATE

WHAT DAY(S) OF THE WEEK?

START TIME

END TIME

GIVE IT A NAME

**SAVE
IT!**

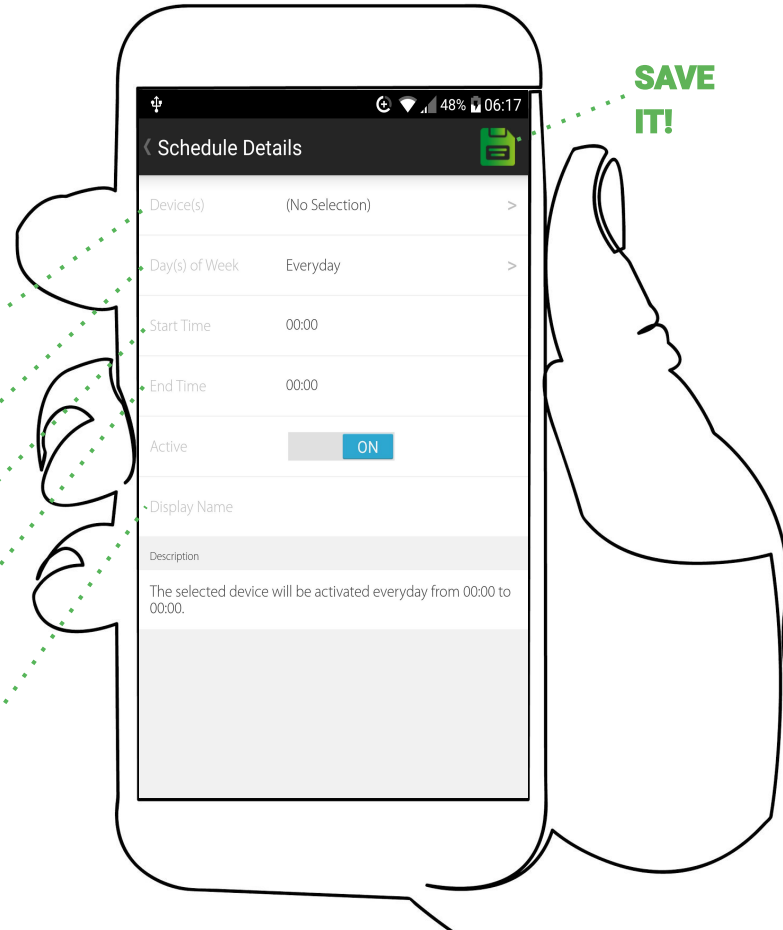

< Schedule Details 

Device(s) (No Selection) >

Day(s) of Week Everyday >

Start Time 00:00

End Time 00:00

Active ON

Display Name

Description

The selected device will be activated everyday from 00:00 to 00:00.



Creating rules: MANUAL TASKS

TO CREATE A MANUAL TASK go to the **RULES** tab on the **MAIN SCREEN** and select **ADD RULE** and then **MANUAL TASK**.

WHAT DEVICE DO YOU WANT TO OPERATE

LENGTH OF DURATION?

ON/OFF

GIVE IT A NAME

**SAVE
IT!**

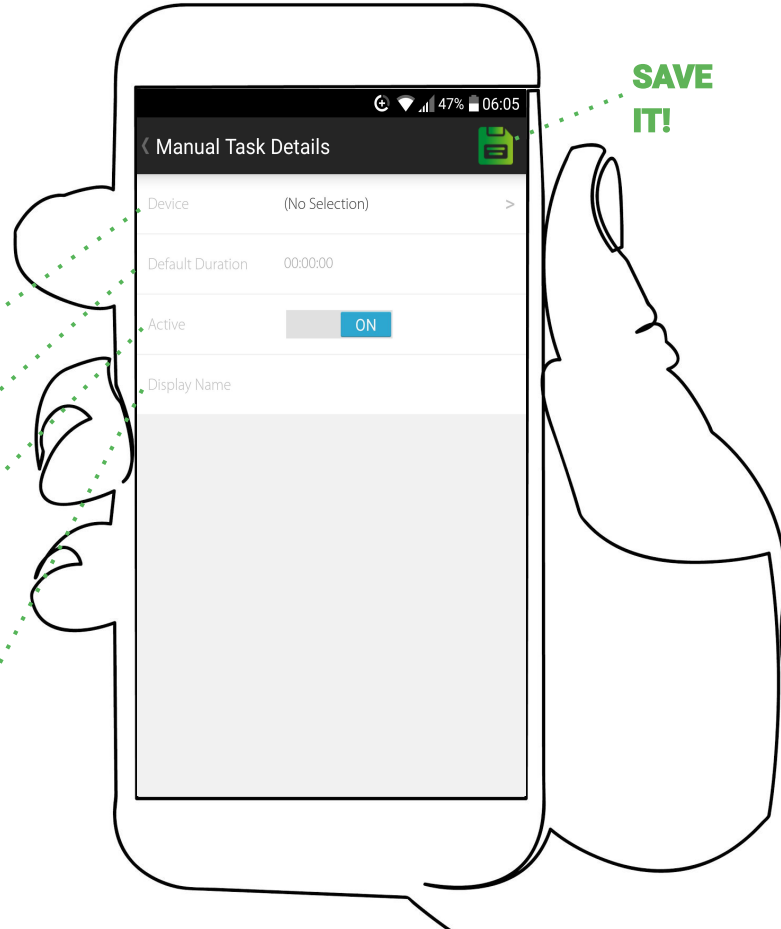

Manual Task Details

Device (No Selection) >

Default Duration 00:00:00

Active ON

Display Name



JOURNAL

The **HASH App's JOURNAL** function is key to your success. It records everything the **ENVIRONMENT SENSORS** pick up and allows you to analyse any one of the parameters over a day, or any custom time period using the calendar to select dates.

The **JOURNAL** also allows users to keep **NOTES** and **PHOTO** updates of the garden to use for later cycles.

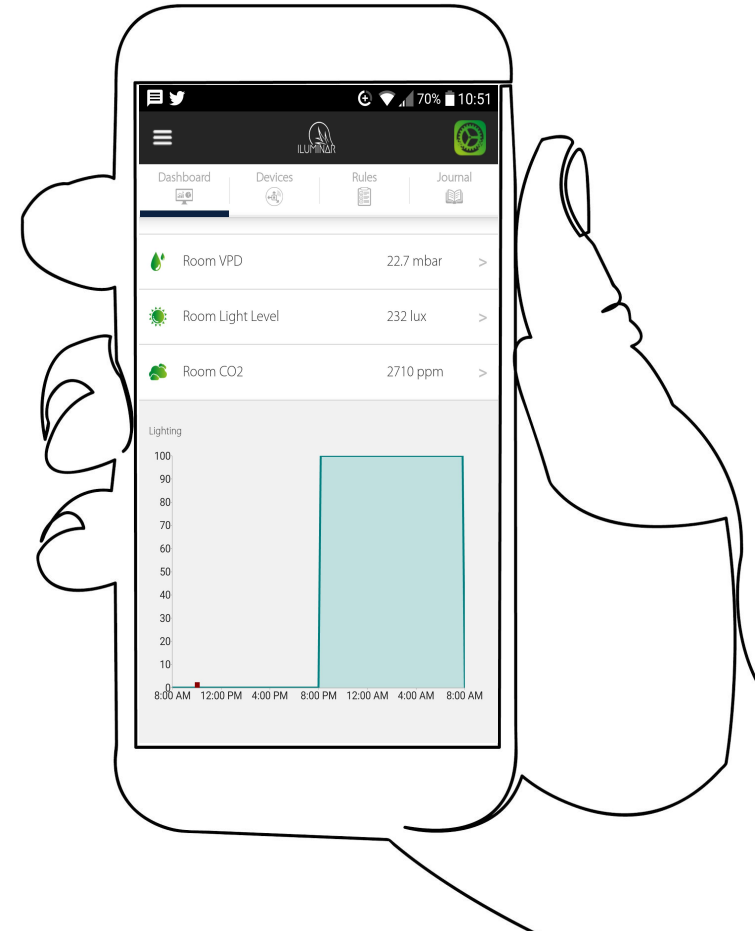



**CALENDAR TO SET
DATE RANGE**

PHOTO JOURNAL

NOTES

**REAL TIME SENSOR
DATA JOURNAL**

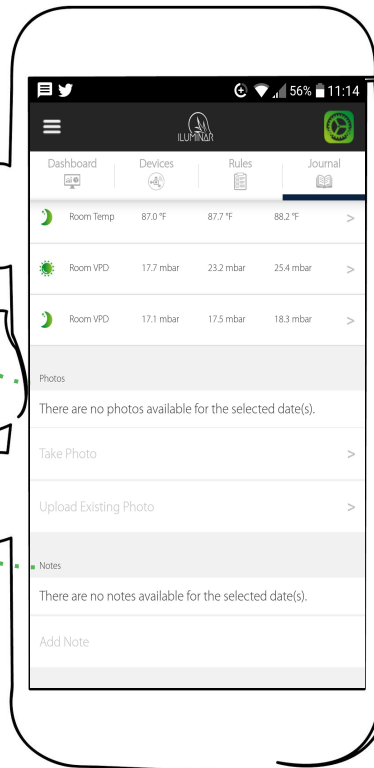
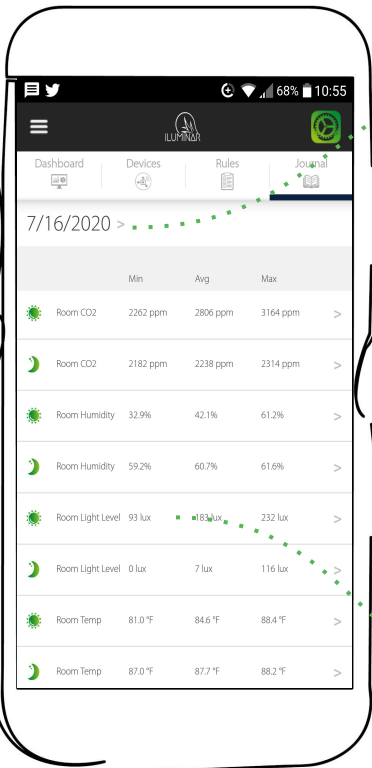



HASH CONTROLLER



TECHNICAL SPECS

Compatible with	LED, HPS, CMH, MH & T5*
# of Zones / Rooms	2-4 Rooms (unlimited with additional slave HASH Controllers)
# of Sensors	UNLIMITED
# of Light Fixtures	UNLIMITED
Operating Temperature	140° F / 50° C
Power External Dim Inputs	12V DC, 1.0 Amp minimum
Temperature Inputs	0 to 10V DC
Dim LED Output	PT1000 probe. No Polarity
Relays	0 to 10V DC. Current / Sourcing Max 300 mA per zone
Connectivity	<48V (AC or DC) 10 Amp fuse protected
CMH / HPS Dim Output	Wifi IEEE 802 11b/g/n0 to 11.5V DC. Current
Browser Compatible	Safari, Chrome, Firefox, or Internet Explorer 9
ILUMINAR APP	OS 8 or later, or Android 4 or later

Dimensions

35mm / 1.4"

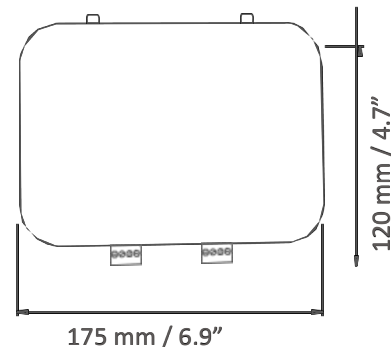

Control light intensity from 0-100% for hundreds of light fixtures per zone. Onboard relays give the ability to control external contactors for cutting power to light fixtures.

Using the HASH app, you can create rule triggers, schedules, timers, remote control, and access data analytics.

The Iluminar LIGHTING-HASH Controller can accept remote firmware updates for a continuously improving system.

Your configured system will continue to run even if you lose network or internet connectivity.

Onboard battery backup allows the system to maintain time synchronization during power and internet glitches.

Reliable & robust onboard power that consists of input power filtering/protection against voltage spikes, EMI/EMF/building power glitches.



HASH

Environmental
SENSOR

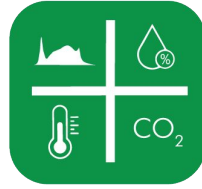

HUMIDITY • HVAC • VPD • PAR • CO2 • LIGHTING • TEMPERATURE

TECHNICAL SPECS

Input Power	9-25V DC, 0.5 Amp minimum
Wireless Communication	2.4 GHz Local RF
Temperature °C	-40 to 85 °C (Accuracy ± 0.5 °C near 25 °C)
Temperature °F	-40 to 185 °F (Accuracy ± 0.9 °F near 77 °F)
Humidity	0 to 99.5% RH (Non Condensing) (Accuracy ± 3%)
Pressure/Altitude	300-1100 hPA (Accuracy ± 1 hPA)
CO2	0 to 5000 ppm (Accuracy ± 2%)
Light	0 to 163,680 lux (Accuracy ± 80 lux)

HARDWARE

Hardware	ARM Cortex M3 Microcontroller
Flash Memory	1MB RAM
RAM	128 K
SD Card	8 GB
Battery Backup	Yes

DIMENSIONS

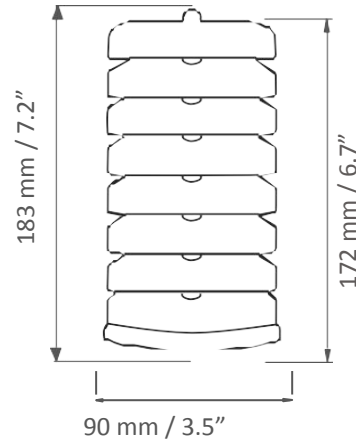

Wifi connected Environmental Sensor connects directly to the ILUMINAR LIGHTING-HASH Controller to deliver real-time data logging directly to a smartphone or device, no PC is required - Control and view various points of data from an unlimited number of devices with additional RELAY POWER Cords - Expand to multiple facilities, rooms and zones with additional Environmental Sensors - Connect to ILUMINAR LIGHTING-HASH Controller for high accuracy monitoring and full control of connected devices - Monitor temperature, humidity, pressure/altitude, CO2, Vapor Pressure Deficit (VPD) and light levels - Utilizes highly accurate and reliable sensors (Bosch BME280 sensor, SH-DS industrial/greenhouse grade CO2 sensor, Phototransistor light sensor) - Includes options for wall mounting or hanging.



Wirelessly turn a device on and off with a ILUMINAR LIGHTING-HASH controller.

Using the ILUMINAR mobile app or online dashboard, you can create rule triggers, schedules, timers, remote control, and access data analytics.

TECHNICAL SPECS

Power Input/Output	120VAC, 60Hz
Relay	10A Max
	Resistive Load (10A Max)
	Inductive Load (2.5A Max)
Wireless Communication	2.4 GHz Local RF
Plug Type	Male NEMA 5-15
Weight of Product	0.05 kg / 0.1lbs

Notes & Best Practices

Metal structures block wireless RF communication signals. If using the power link cable inside a metal structure, make sure the ILUMINAR LIGHTING-HASH controller is also inside the same metal structure. The RF range can reach up to 1100 meters if direct line of sight between the power link cable and the ILUMINAR LIGHTING-HASH controller is established. In a dense industrial/greenhouse environment full of equipment, shelving, plants, etc. with no line of sight, the RF range is typically closer to 50 to 100 meters.

Make sure to consider the maximum current draw of the device that is plugged into the power link cable. Devices such as compressors, motors, solenoids, transformers, contactor coils, etc. are examples of inductive loads. When an inductive load is turned on, it will have a short in duration, but significantly high current draw spike. These spikes can draw 4 times as much current, and in some cases over 10 times as much current. If this high current draw spike exceeds the 10 amp rating, the power link cable can be damaged. Devices such as incandescent lamps, electric heaters, hot plates, etc. are examples of resistive loads and typically have no current spike when switched on.



HASH

CONTROLLER APP



INSTRUCTION MANUAL

