

GROWONIX

TUNED FOR GROWING



BP-6010 BP-6010-CH ESOK OWNERS MANUAL

WWW.GROWONIX.COM



GROWONIX
TUNED FOR GROWING



Built in the U.S.A.

INTRODUCTION

OUR MISSION

Durability, Reliability, Efficiency, Purity, and Conservation form the foundation on which we design and build all of our products. Consistent and superior quality sets us apart from other manufacturers and increases our value to you - our customer. Whether you are a hydroponics hobbyist, serious enthusiast, or large-scale gardener, GrowoniX is committed to bringing you the best solution for water purification systems.

WHAT IS REVERSE OSMOSIS?

Reverse osmosis (RO) is a filtration method that removes many types of large molecules and ions from solutions by applying pressure to the solution when it is on one side of a selective membrane. This filtering process ensures that the solute (waste water) is contained within the pressurized chamber while the pure solvent (RO water) is allowed to pass freely through the membrane.

TUNED FOR GROWING - IN TUNE WITH OUR CUSTOMERS

Traditional RO systems have waste ratios of approximately 4:1, which means there are 4 gallons of waste water produced for every 1 gallon of purified water. GrowoniX line of water filters achieve waste ratios of 2:1 with all 200-400 GPD systems, and an astounding 1:1 ratio with the 600-1000 GPD systems.

GrowoniX has created a complete product line that will address the needs of hydroponic operations of all sizes. Our filters will significantly reduce your water use while dramatically increasing your yields.

THE TRADITIONAL WAY

takes 4 gallons of waste water to produce 1 gallon of pure water

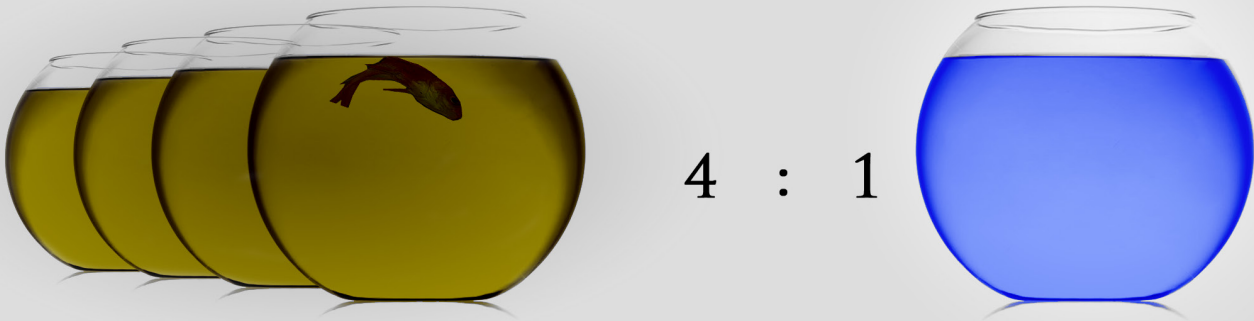

THE GROWONIX WAY



FEATURES

- ✔ DOUBLES PURE WATER PRODUCTION FOR ALL 600-1000 GPD SYSTEMS-MAX 2000 GPD.
- ✔ ONLY NEEDS 30PSI OF INCOMING WATER PRESSURE TO PRODUCE THE FULL FLOW RATE.
- ✔ LOW-PRESSURE CUTOFF TO SAFEGUARD AGAINST A LOSS OF INCOMING WATER PRESSURE.
- ✔ STAINLESS STEEL LIQUID-FILLED 300PSI PRESSURE GAUGE.
- ✔ CONTINUOUS DUTY CYCLE
- ✔ ADJUSTABLE OUTPUT PRESSURE
- ✔ CONTROLLABLE MANUALLY OR WITH ESOK (ELECTRIC SHUTOFF KIT)
- ✔ PATENTED ELECTROGALVANIZED BRACKET ON BP-6010-CH



 No Assembly Required

WHY USE A GROWONIX BP-6010 PUMP?

Membranes love pressure! In general, more pressure allows for better membrane rejection, longer life, and increased flow rate. GrowoniX BP-6010 Series Booster Pumps allow for the full potential performance of an RO system to be achieved—with only 35 PSI of incoming water pressure. The perfect solution for those with low feed water pressures, and those who want to receive the maximum performance from their GrowoniX water filter.

Part #	In / Out	Voltage	Amps	Flow Rate	High Pressure Cutoff	Duty Cycle	FITS
BP-6010-CH	1/2" / 3/8" OD tube	240 VAC	5.6	2.6 GPM	No	Constant	EX600, EX1000, GX600, GX1000
BP-6010	1/2" / 3/8" OD tube	120 VAC	5.6	2.6 GPM	No	Constant	EX600, EX1000, GX600, GX1000

BASIC INFORMATION

**READ ENTIRE MANUAL THOROUGHLY
BEFORE INSTALLING THIS HIGH PRESSURE-BOOSTING PUMP.**

ABOUT

- The BP-6010 series of Booster Pumps are designed for use with all GrowoniX EX1000 & GX1000 water filters.
- The pump is designed to boost low water pressure conditions to optimal pressure.
- Do not exceed 150 psi output pressure.

CAUTIONS

- The pump is equipped with an adjustable bypass valve which controls the maximum operating pressure. In addition, never subject the pump to pressures above 150 PSI.
- Never operate the pump in a harsh environment or hazardous atmosphere, since motor brush and switch may cause electrical arcing.
- Pumphead materials are designed for use with water only. Do not use with petroleum products.
- Always consider electrical shock hazard when working with and handling electrical equipment. If uncertain, consult an Electrician. Electrical wiring should only be done by a qualified Electrician per Local and State Electrical Codes.

MOUNTING

- The pump should be mounted in a dry place and away from any source of heat. If an enclosure is used, special provisions for cooling the motor may be necessary. Consult the Factory.
- Do not subject the pump to extreme high or low (freezing) temperatures while in operation. (Operating ambient temperature range is 32°F to 115°F).
- The pump may be mounted in the vertical or horizontal position.

GROWONIX WATER FILTERS USE QUICK CONNECT FITTINGS THAT ALLOW FOR EASY MAINTENANCE.

MAKE A CLEAN TUBE CUT

Cut the tube squarely and if using plastic tubing, ensure that the cut has not made the tube out of round.

Also ensure that the tube has a smooth outside diameter without any burrs or score marks prior to inserting it into the fitting.

INSERT TUBE INTO FITTING

Push the tubing through the collet and dual o-rings until it bottoms out against the tube stop.

The collet holds the tube in place and the dual o-rings provide a leak resistant seal.

TEST AND INSPECT

Push and pull the tubing toward and away from the fitting to ensure that it has been installed properly.

Test and inspect the installation for any leaks.

TUBE REMOVAL

Relieve pressure from the tubing and fitting. Push uniformly around the collet flange against the fitting body while pulling the tubing away from the fitting to release it.

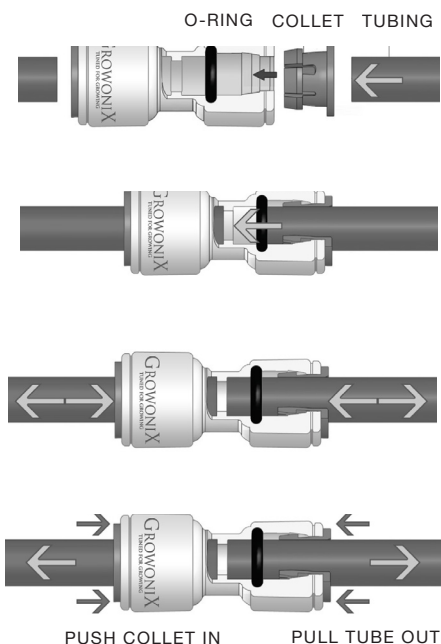

PLUMBING AND ELECTRICAL

PLUMBING

- The input to the BP-6010 pump is 1/2 OD" tubing size.
 - The output is 3/8" OD tubing. the ESOK is 3/4" or 1".
-

CAUTIONS

- Do not use garden hose fittings or attachments when using a BP-6010 series pump, especially when using an ESOK (electric shutoff kit). It is only recommended to plumb the RO system with appropriate SCH40/80 PVC, copper, or CTS pipe suitable to pass local plumbing inspections in your area.
 - Any restrictions or blockage in the drain line of the RO system can cause back pressure, which will increase the system's operating pressure. This can result in damage to the system's membranes and components and a potentially DANGEROUS OVERPRESSURIZATION CONDITION.
-

ELECTRICAL

- The motor is a carbonator motor. It is available in 110/220 and 50/60 hertz 1 phase 5.6A. Please ensure that the electrical circuit supplying the system is compatible with the requirements of the BP-6010 pump. Each BP-6010 pump is equipped with an 8" electrical cord.
-

NOTE

WE RECOMMEND THAT A LICENSED ELECTRICIAN WIRE YOUR SYSTEM IN ACCORDANCE WITH LOCAL AND NATIONAL ELECTRICAL CODES (NEC).

WARNING

TO REDUCE THE RISK OF ELECTRICAL SHOCK, THE INCOMING POWER SUPPLY MUST INCLUDE A PROTECTIVE EARTH GROUND.

BP-6010 INFORMATION

*** THE PUMP MUST NEVER BE RUN DRY. OPERATING THE PUMP WITHOUT SUFFICIENT FEED WATER WILL DAMAGE THE PUMP. ***

ALWAYS FEED THE PUMP FILTERED WATER. THE PUMP IS SUSCEPTIBLE TO DAMAGE FROM SEDIMENT AND DEBRIS.

IF ANY DAMAGE OCCURS TO YOUR SYSTEM'S PUMP, A RE-BUILD KIT MAY BE AVAILABLE. CONTACT YOUR LOCAL DEALER OR DISTRIBUTOR AND INFORM THEM OF YOUR SYSTEM'S MODEL AND PUMP SIZE.

- The pump is a low-lead brass rotary vane pump.
- This pump is also available in stainless steel.
- Follow these guidelines to ensure proper operation of the pump:

PRESSURE SWITCH HAS ONLY TWO ADJUSTMENT TERMINALS

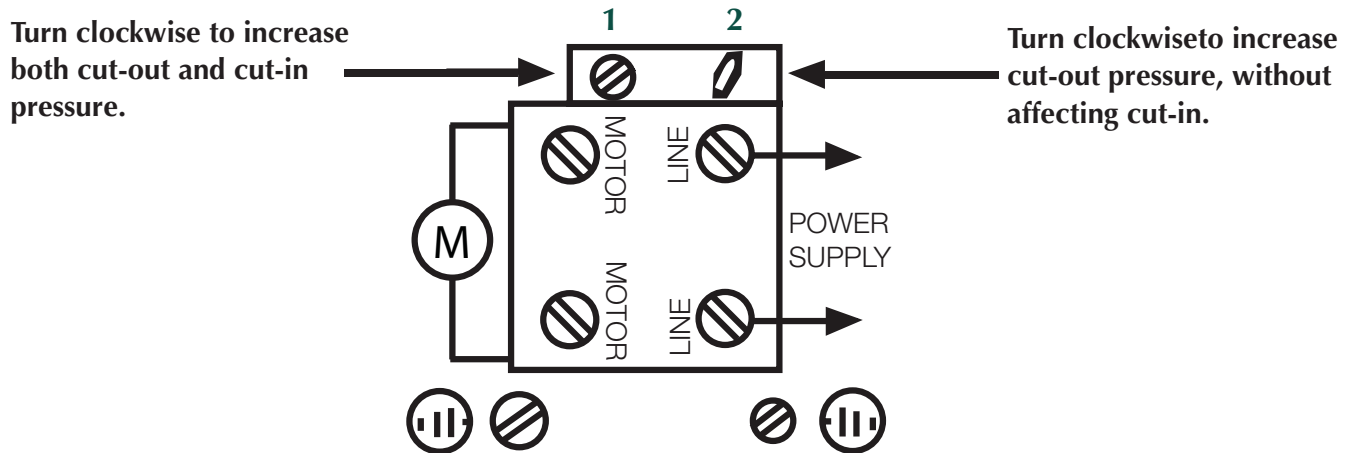

WATER PUMP PRESSURE SWITCH

The low pressure switch shuts off the system when the feed water pressure drops too low for the system to function properly. This prevents damage to the pump. The system restarts automatically when the pressure is restored. If you notice the pressure fluctuating, and the system cycling off and on repeatedly, turn the system off and ensure that proper feed flow and pressure are available to the system.

WATER PUMP PRESSURE SWITCH ADJUSTMENT

The water pump pressure switch is adjusted at the factory to cut out when incoming pressure falls below 10 psi, and cut in when incoming pressure reaches 25 psi.

PRESSURE SWITCH SHOULD NOT NEED ADJUSTMENT.

If for some reason pressure switch should fall out of adjustment, follow the diagram above. Factory settings are:

Terminal 1 adjusted fully counterclockwise.

Terminal 2 adjusted fully counterclockwise.

COMPONENT DIAGRAM

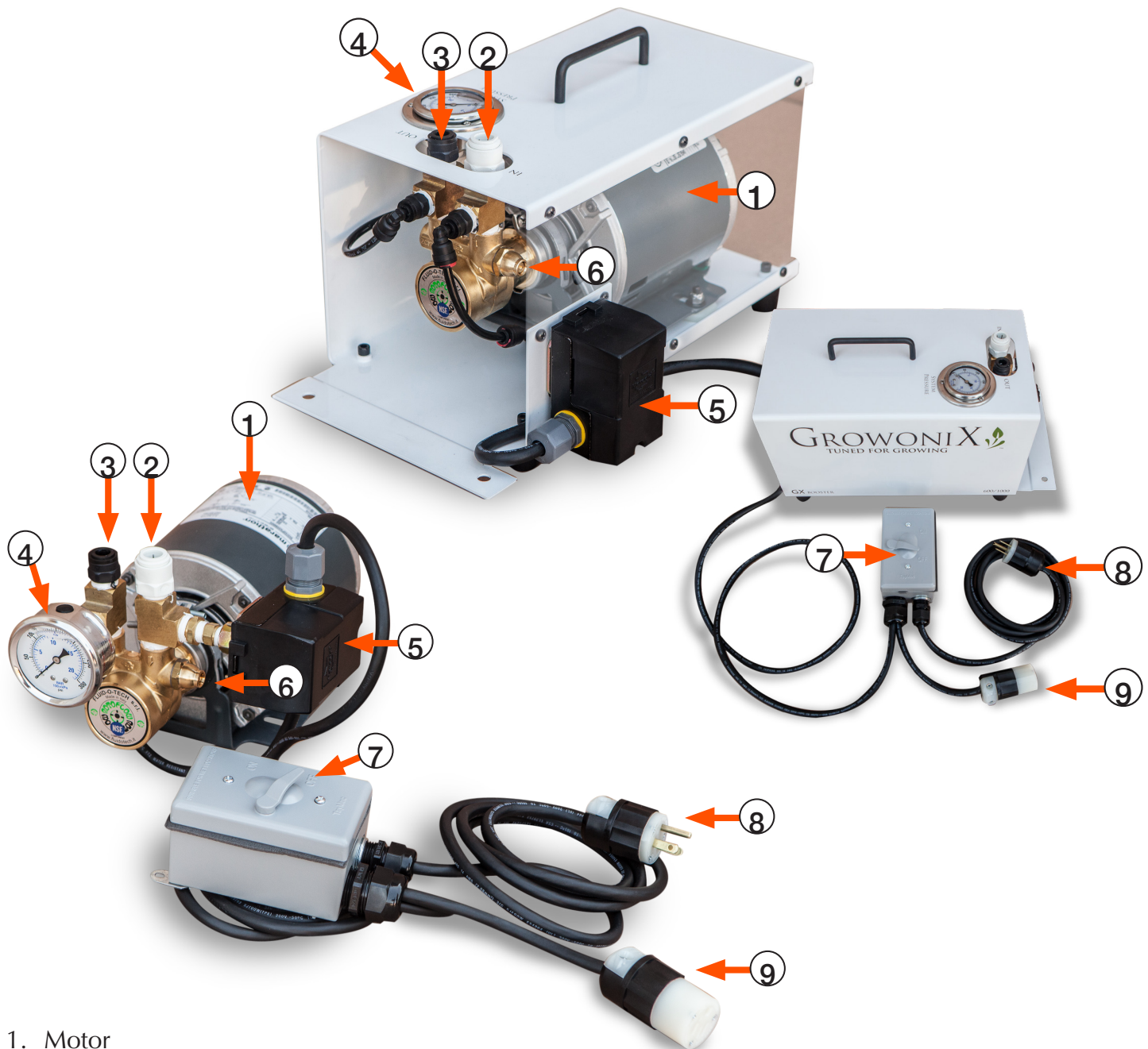

1. Motor
2. 1/2" Pump Input (connection to pre filter housing output)
3. 3/8" Pump Output (connection to membrane input)
4. Output Pressure Gauge
5. Low Pressure Switch
6. Pump Pressure Bypass Adjustment
7. Pump Power On/Off Switch
8. AC Cord
9. Piggyback Cord for ESOK (Solenoid Valve Shutoff Kit)

**READ ENTIRE MANUAL THOROUGHLY
BEFORE INSTALLING THIS HIGH PRESSURE-BOOSTING PUMP.**

SETUP INSTRUCTIONS FOR BP-6010

IMPORTANT TIPS:

 **TURN OFF INCOMING WATER SUPPLY AND DRAIN SYSTEM PRESSURE BEFORE INSTALLING A BP-6010 PUMP**

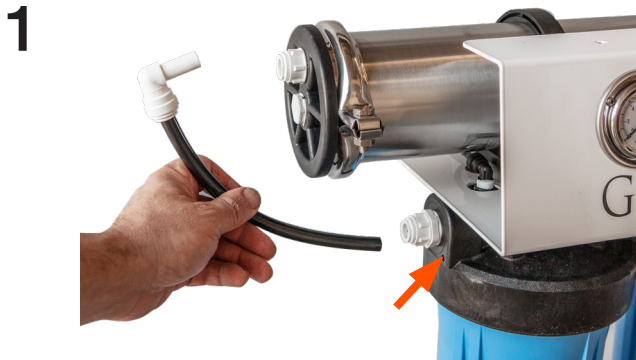

Slide the 1/2" locking clip off of the carbon filter output fitting, and remove the short length of 1/2" tubing feeding the membrane input.



Insert the supplied 1/2" tubing into the carbon filter output. Install the 1/2" locking clip.

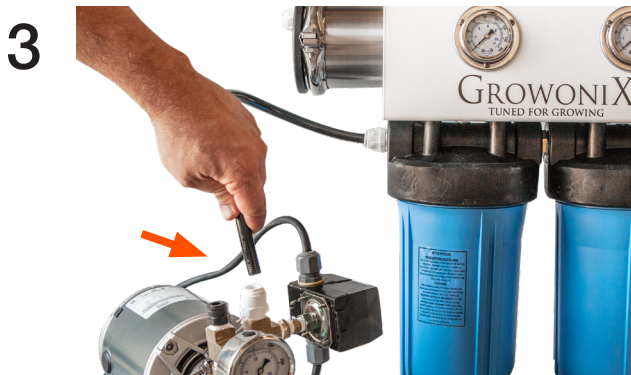

Cut the tubing to the appropriate length (ensure no kinks or flow restrictions), and insert into the 1/2" pump input. Install the 1/2" locking clip.



Insert the supplied 3/8" tubing into the pump high pressure output. Install the 3/8" locking clip.

5

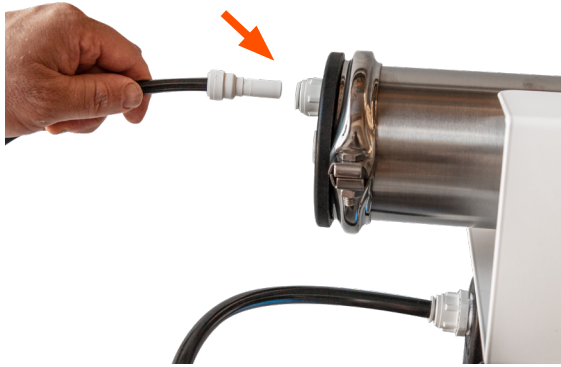

Cut the 3/8" tubing to the appropriate length (ensure no kinks or flow restrictions), and install the 1/2" x 3/8" stem reducer onto the 3/8" tubing. Insert the stem reducer into the 1/2" membrane input fitting.

6

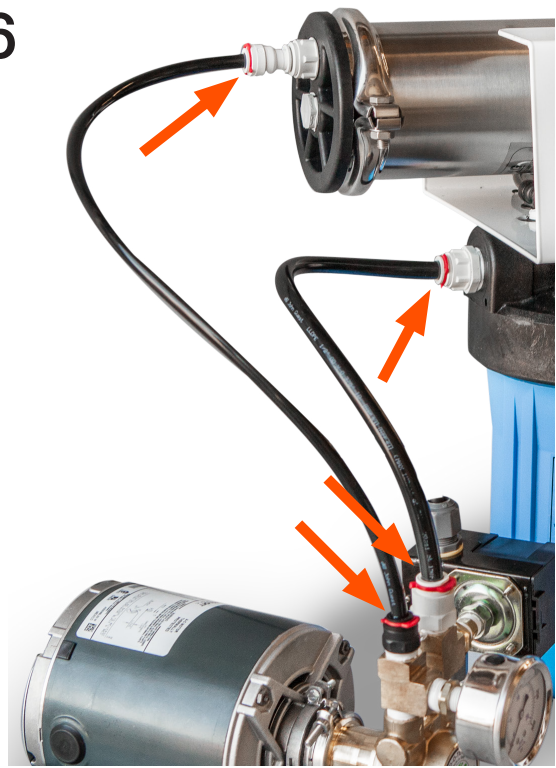

Complete assembly as shown, with red locking clips in the correct places.



SETUP INSTRUCTIONS FOR BP-6010-CH

TURN OFF INCOMING WATER SUPPLY AND DRAIN SYSTEM PRESSURE BEFORE INSTALLING A BP-6010 PUMP



1 Install the caster onto the chassis bottom.



2 Attach BP-6010-CH chassis to GX600/1000 housing using the existing caster hardware.

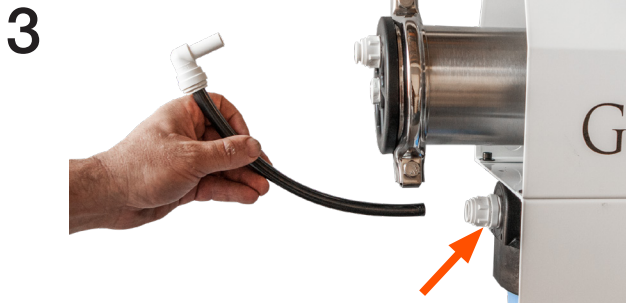

3 Slide the 1/2" locking clip off of the carbon filter output fitting, and remove the short length of 1/2" tubing feeding the membrane input.



4 Insert the supplied 1/2" tubing into the carbon filter output. Install the 1/2" locking clip.



5 Cut tubing to the appropriate length (ensure no kinks or flow restrictions), and insert into the 1/2" pump input. Install the 1/2" locking clip.



6 Insert the supplied 3/8" tubing into pump high pressure output. Install the 3/8" locking clip.

7



Cut the 3/8" tubing to the appropriate length (ensure no kinks or flow restrictions), and install the 1/2" x 3/8" stem reducer onto the 3/8" tubing. Insert the stem reducer into the 1/2" membrane input fitting.

8

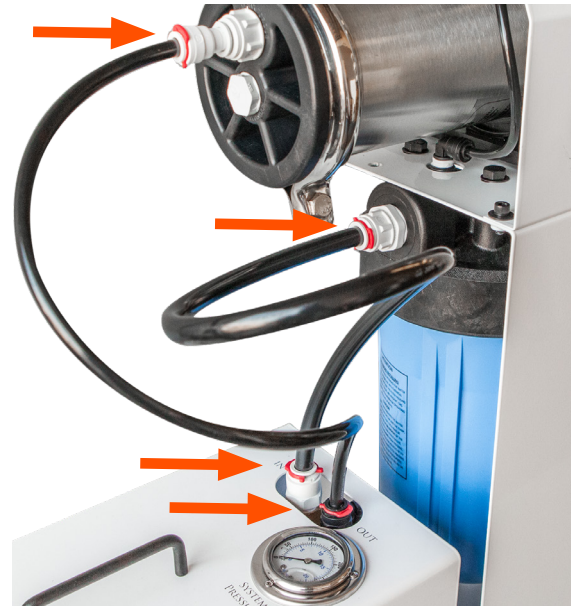

Complete assembly as shown, with red locking clips in the correct places.



PUMP OUTPUT PRESSURE ADJUSTMENT

BP-6010 PUMP



BP-6010-CH PUMP



The bypass valve, located on the input side of the pump can be used to regulate pump output pressure. It is adjustable with a flat head screwdriver.

WHILE REFERENCING THE PUMP PRESSURE GAUGE:

1. Turn the screw clockwise to INCREASE system pressure.
2. Turn the screw counterclockwise to DECREASE system pressure.

MINIMUM SYSTEM PRESSURE IS 40PSI.
MAXIMUM SYSTEM PRESSURE IS 150 PSI.

- Running the system at higher pressure will result in failure of fittings, overheating of the pump motor, and possible injury.
- As membranes foul, system pressure increases. Make sure you leave some headroom so that a pressure increase due to fouling DOES NOT EXCEED 150 PSI.

ELECTRIC SHUT OFF KIT COMPONENT DIAGRAM



1. SOLENOID VALVE
2. FLOAT BALL SWITCH
3. FLOAT BALL PIGGYBACK CORD
4. SOLENOID VALVE MANUAL OVERRIDE SWITCH
5. SOLENOID VALVE (DIRECTION OF FLOW)

SOLENOID MANUAL OVERRIDE SWITCH

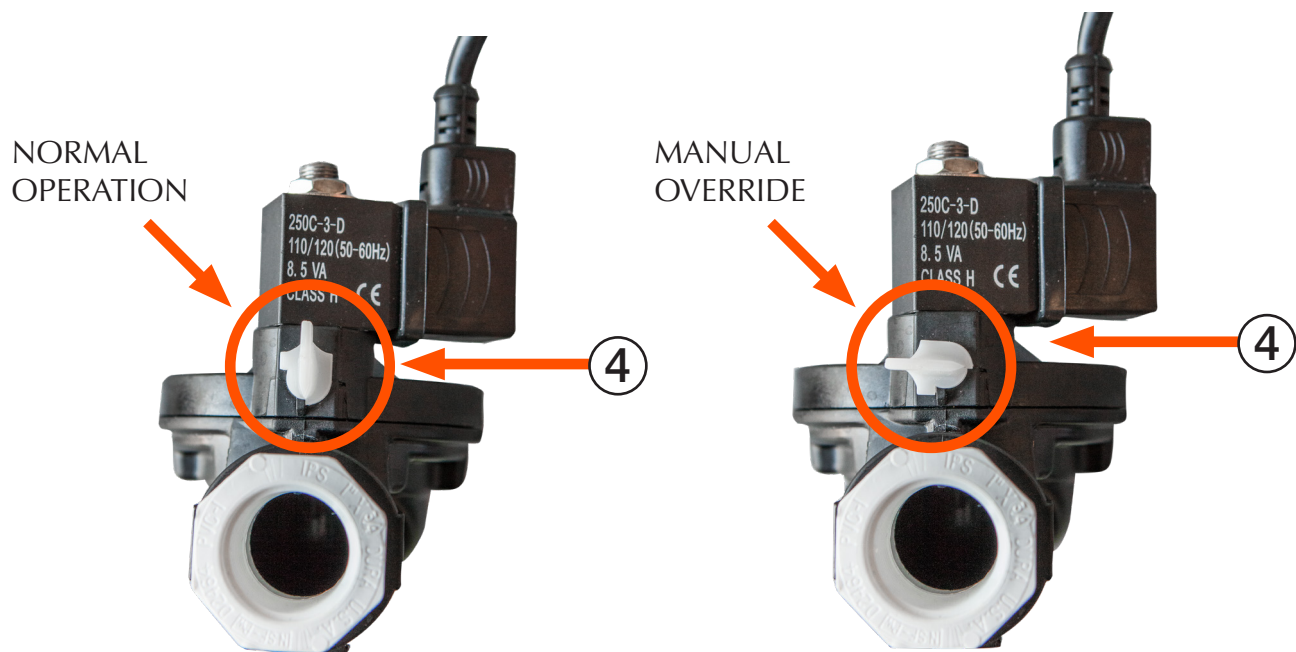

(ESOK) ELECTRIC SHUT OFF KIT CONNECTION



DISCONNECT PUMP AND ALL COMPONENTS FROM ELECTRICAL SUPPLY, AND TURN OFF FEED WATER SUPPLY BEFORE CONNECTING THE ESOK.

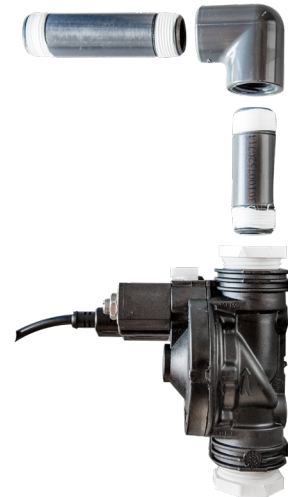

INSTALLING THE SOLENOID VALVE

1. Remove the garden hose fitting from the water filter input and attach the supplied SCH80 PVC as shown above.
2. Install the solenoid valve on the input of the EX/GX1000, making sure valve is installed in the correct direction of flow. (see arrow stamped on valve housing and reference pg. 13).
3. Make sure the override switch is in the “Normal Operation” position (see: page 13).
4. Turn on feed water supply and check for leaks in the solenoid valve water connections.

INSTALLING THE FLOAT BALL SWITCH

Normally closed float switches are closed while hanging “down”, and will open on a rising liquid level—typically used for “tank filling” applications.

1. Determine the desired cord tether length . See Figure 2.
2. Attach the Pipe Clamp at the desired location. See Figure 1.
3. Adjust the tether length to achieve the desired pumping range. Use Figure 2 as a guide and test the system by filling tank and cycling the system to achieve the actual desired pumping range. Tighten the clamp

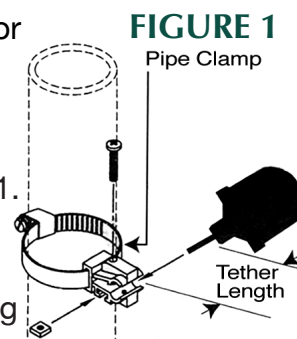

FIGURE 1

FIGURE 2

Tether Length	Pumping Range
4"	8"
5"	9"
6"	10"
7"	11"
8"	12"
9"	13"
10"	14"
11"	15"
12"	16"
13"	17"
14"	18"
15"	19"
16"	20"
17"	21"
18"	22"

WARNING:

Read instructions thoroughly. Check local codes and install to meet requirements.

Turn off all power when installing or adjusting unit.

Failure to turn off all power could result in serious injury or death!

End user to provide overcurrent protection rated at 120VAC minimum, 15 Amps maximum.

(ESOK) WIRING DIAGRAM

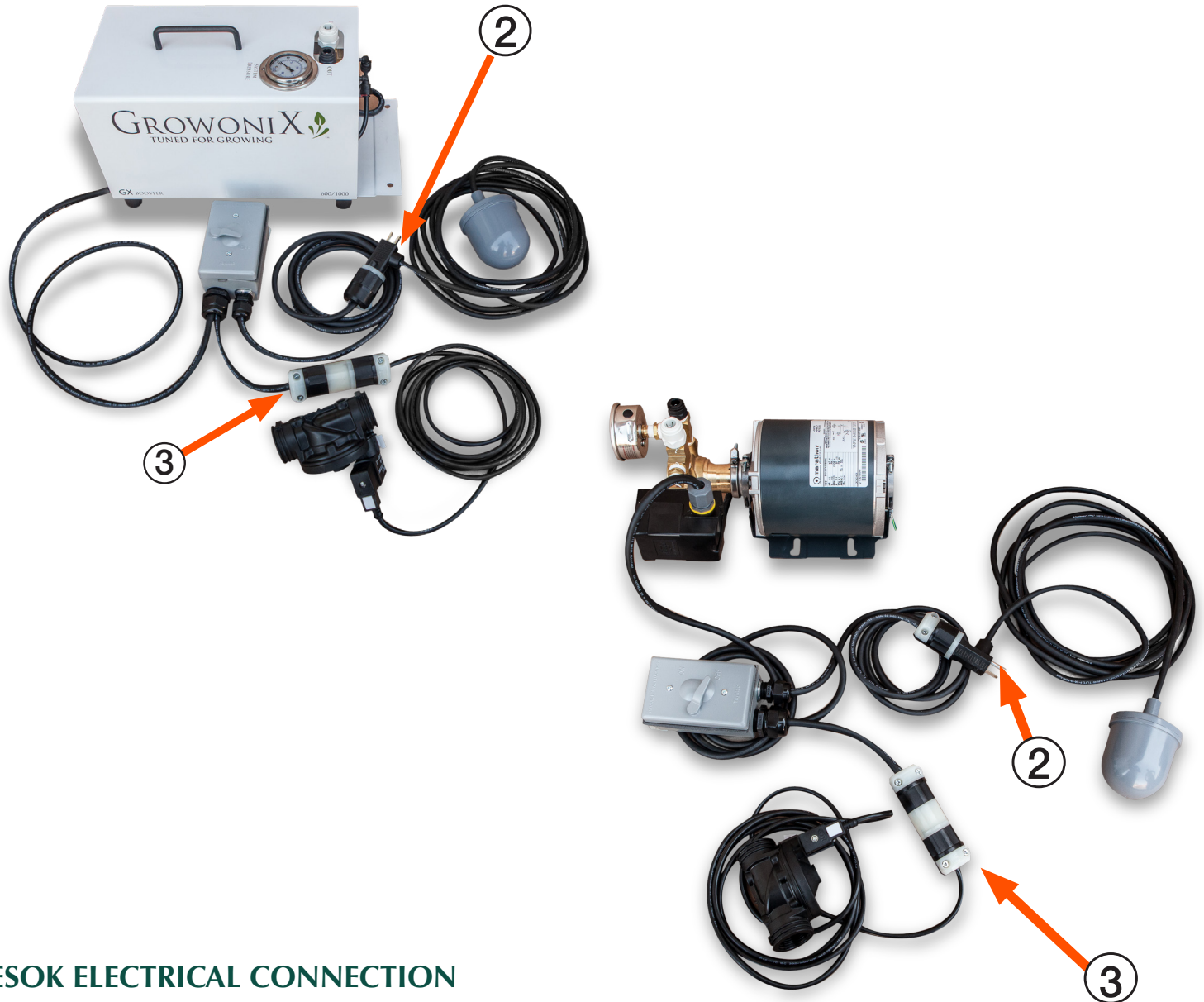

ESOK ELECTRICAL CONNECTION

1. Attach the float ball piggyback cord to the male plug end from the pump control box.(2)
The float switch will now govern whether current will flow to the pump control box or not.
2. Plug the solenoid valve into the female plug end extending from the pump control box (3).

- Float ball facing “UP” = current does not flow (pump off).
- Float ball facing “DOWN” = current flows (pump on).
- When pump control switch is “ON” **and** float ball is facing “DOWN” = current will flow to the solenoid valve and the valve will open.
- When pump control switch is “OFF” **or** the float ball is facing “UP” = no current will flow to the solenoid valve, and the pump will not run.

GROWONIX SYSTEM WARRANTY

For a period of one year from the date of original purchase, we will replace or repair any part of the GrowoniX product that we find to be defective in operation due to faulty materials or workmanship with the exception of the replaceable filters and membranes.

GENERAL CONDITIONS

Damage to any part of this product because of misuse; misapplication; negligence; alteration; accident; installation; or operation contrary to our instructions, incompatibility with accessories not installed by GrowoniX, or damage caused by freezing, flood, fire, or Act of God, is not covered by this warranty. In all such cases, regular charges will apply. This limited warranty does not include service to diagnose a claimed malfunction in this unit. This warranty is void if the claimer is not the original purchaser of the unit or if the unit is not operated under normal municipal water or well water conditions.

GrowoniX assumes no liability in connection with this product. GrowoniX assumes no liability for any damages incurred through the use of this product. It is the responsibility of the end user to gauge the safe use of this product in the environment where it is applied. We do not authorize any person or representative to assume for us any other obligations on the sale of this reverse osmosis system. The information given out in the manual we believe to be true, but are offered to you in good faith without guarantee because each application of this product is different and beyond our control.

GROWONIX RETURN POLICY

MERCHANDISE RETURN DETAILS AND PROCEDURE:

If any merchandise was defective —we will refund the full purchase price upon receiving and reviewing the merchandise returned in undamaged condition.

RMA NUMBER:

You must first obtain a Return Merchandise Authorization (RMA) number from GrowoniX.com. Any products sent to GrowoniX without an RMA number will not receive a refund and may be returned to the sender at their expense.

All refund amounts will be based on the manufacturer's warranty and GrowoniX return policy. Refunds will be issued back using the payment method you used when you placed your order. Refunds take up to 3-5 business days to process once we receive the return.

PACKAGING:

Please kindly re-pack the product in its original box, or a box of equivalent strength. The unit should be packed in the same manner as it came to prevent damage in shipping. Please return everything that was in the original box, including any free items if applicable. Be sure to drain out all water from wet systems and parts and wrap them in plastic bags before packing.

RETURN TO:

We will provide you with an GrowoniX warehouse address for return merchandise when we issue the RMA number.