

---

INSTRUCTION MANUAL

---

**ACTIVE AIR<sup>®</sup>**

---

PORTABLE AIR CONDITIONER

---



ACAN1402













**HYDR FARM<sup>®</sup>**

# INSTRUCTION MANUAL

Thank you for purchasing the Active Air Portable Air Conditioner (ACAN1402). This unit features cooling, dehumidifying, fan, and auto mode operation.

## WHAT'S IN THE BOX

After unpacking the box, please confirm that all of the following parts and accessories are included.

	2 - Unit Adaptor		2 - Foam Seal A (Adhesive)
	2 - Exhaust Hose		2 - foam Seal B (Adhesive)
	2 - Window Slider Adaptor		1 - Foam Seal C (Non-adhesive)
	1 - Bolt		1 - Security Bracket and 2 screws
	1 - Window Slider A		1 - Drain Hose
	1 - Window Slider B		1 - Remote Controller and Battery

## Overview of Air Conditioner Unit

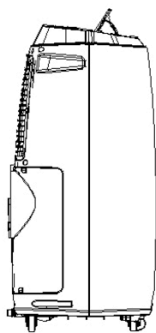

Side view



Front view

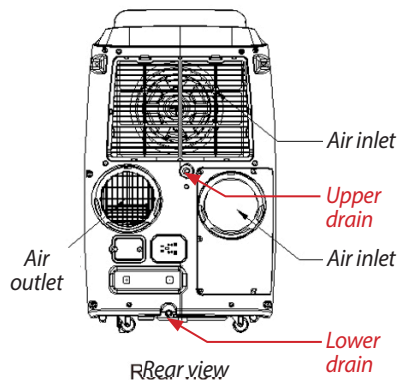

Rear view

# INSTRUCTION MANUAL

## Control Panel and Remote Control

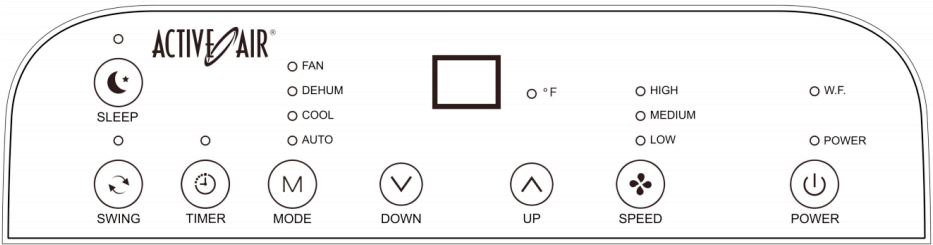

- The **POWER** button turns the power on or off to the portable air conditioner.
- The **SPEED** button determines the fan speed.
- The **TEMP+** button raises the temperature by one degree.
- The **TEMP-** button lowers the temperature by one degree.
- The **MODE** button toggles the air conditioner between fan, dehumidify, cooling, and auto modes.
- The **SLEEP** button controls night time operation.
- The **TIMER** button operates the air conditioner's timer.
- The **SWING** button toggles louver movements between ON and OFF.



# INSTRUCTION MANUAL

## SAFETY

Before installing and using the portable air conditioner, please review this manual, including the following safety recommendations.

 **\*IMPORTANT:** *If any parts are damaged, turn off the Power switch and disconnect the power supply immediately. Contact an authorized service technician for repair or maintenance of this unit. If the supply cord is damaged, it must be replaced by the manufacturer, its service agent or similarly qualified persons in order to avoid a hazard.*

1. Plug the unit into properly grounded power outlets only.
2. Do not use an adapter plug, surge protector, power splitter, or extension cord with the unit.
3. Install the unit in accordance with national wiring regulations.
4. Do not place the unit in any position besides vertical/upright, even temporarily or for storage.
5. Maintain at least 12 inches of clearance around the unit. Do not cover or block air flow through the inlet or outer grilles, as doing so may result in internal damage to the unit.
6. Do not vent the unit into an attic or crawlspace, as the exhausted humidity is very likely to cause mold problems.
7. Wait three minutes before restarting cooling mode if the unit is turned off or power is lost.
8. Never place or use flammable vapors or liquids near the unit, or where exposure to fire is possible.
9. Do not pour or spray water directly on the unit or into the grilles, or use in an area where water is likely to splash, such as a bath, shower, or swimming pool.
10. Do not operate or stop the unit by inserting or pulling out the power plug; this may cause electric shock or fire due to heat generation.

11. Do not pull, deform, or modify the power supply cord, or immerse it in water. Pulling or misuse of the power supply cord can cause electrical shock and/or damage the unit.
12. Never insert anything into the air outlet.
13. Always disconnect power supply before cleaning the air conditioner.
14. Before moving the air conditioner, always turn it off, disconnect the power supply, and move it slowly.
15. Unplug the unit if strange sounds, smell, or smoke come from it.
16. Do not allow children to access the unit.
17. Recycling: This mark indicates that this product should not be disposed with other household wastes throughout the EU. To prevent possible harm to the environment or human health from uncontrolled waste disposal, recycle it responsibly to promote the sustainable reuse of material resources. To return your used device, please use the return and collection systems or contact the retailer where the product was purchased. They can take this product for environmental safe recycling.



 **\*IMPORTANT:** *Any person who is involved with working on or breaking into a refrigerant circuit should hold a current valid certificate from an industry-accredited assessment authority, which authorizes their competence to handle refrigerants safely in accordance with an industry recognized assessment specification. Maintenance and repairs shall be performed only as recommended by the equipment manufacturer. Maintenance and repair requiring the assistance of other skilled personnel shall be carried out under the supervision of a person competent in the use of flammable refrigerants.*

## INSTALLING THE AIR CONDITIONER

Before you begin, determine where to install the air conditioner. If you are using the included window kit, the location must be near a window. Otherwise, we recommend three to four feet of separation between the intake and exhaust holes. The location must also have a power outlet (we recommend running the unit on a dedicated 15A circuit if possible). Be sure to maintain at least 12 inches (30 cm) of clearance around the unit at all times as shown in Figure 1.

**NOTE:** Do not attempt to operate this unit without properly ventilating it, as this will not work to cool the room and will void the warranty. The exhaust and intake ducts must be routed outside the room to the exterior of the structure.

### Window Slider Kit Installation

The window slider kit can be installed in a window that opens horizontally or vertically; the installation process is the same for both. Before installing the window slider kit, make sure your window meets the minimum and maximum size requirements shown Figure 2.

1. Clear and clean the windowsill where you will install the air conditioner.
2. Open window and attach window kit to window.
3. Expand the exhaust hose to its full length.
4. Take out the unit adaptor from box, spin in the hose end into unit adaptor.
5. Snap in the hose end with unit adaptor into the groove of air outlet on the back of the machine.
6. Insert the hose end with window adaptor into the hole of the window kit.
7. Repeat Step 4–7 for the second exhaust hose.
8. Close the window so it that it holds the window unit kit firmly in place.
9. Insert the power cord into a grounded AC 120V/60 Hz receptacle.
10. Press the ON/OFF button to turn on the air conditioner.

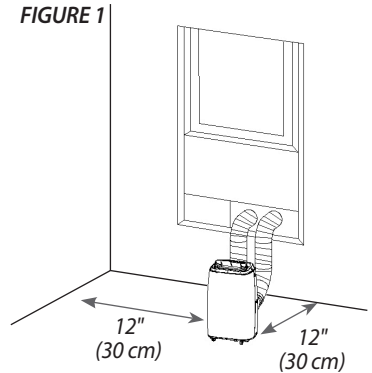

**FIGURE 2**

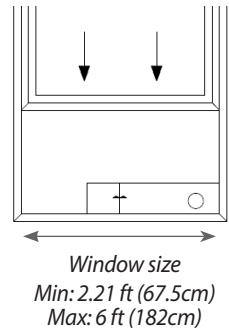

**FIGURE 3**

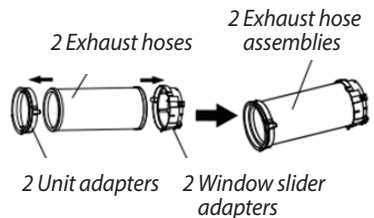

# INSTRUCTION MANUAL

## USING THE AIR CONDITIONER

**⚠️ \*CAUTION:** Always wait at least three minutes before switching from cooling to dehumidifying.

### Important: Operation temperature range

	MAXIMUM COOLING	MINIMUM COOLING
DB/WB	95°/75°F	64°/5°F

### AUTO Mode

In Auto mode, the air conditioner automatically selects the mode (Cooling, Dehumidifying, or Fan) in response to room temperature. It cools above 79°F and dehumidifies under 70°F. For horticultural applications, Cooling mode should be used instead.

Press **DOWN** and **UP** at the same time and hold for 3 seconds to change the parameters from Fahrenheit to Celsius or vice versa. While the unit is set in Celsius, the LED light besides will be off.

ROOM TEMPERATURE(Tr)	Tr<73°F	73F≤Tr < 70°F	Tr ≥ 79°F
MODE	FAN	DEHUMIDIFY	COOLING
Set Temperature	70°F	73°F	77°F

### Cooling

1. Press the **MODE** button until the “Cool” icon – which looks like a snowflake – appears.
2. Press the **TEMP+** or **TEMP-** button until the desired room temperature appears.
3. Press the **SPEED** button to select wind speed (Low, Medium, or High).



### Dehumidifying

Press the **MODE** button until the “Dehumidify Indicator Lamp” icon – which looks like a water droplet – lights up. The temperature will drop 2° F lower than the room temperature. This temperature change is not adjustable.

### Fan

1. Press the **MODE** button until the “Fan” icon appears.
2. Press the **SPEED** button to select wind speed (Low, Medium, or High).

# INSTRUCTION MANUAL

## Turning the Timer ON/OFF

1. Power on the air conditioner to turn off the timer and power off the air conditioner to turn on the timer. Press the **TIMER** button.
2. Press the **TEMP+** or **TEMP-** button to set the desired on-time. The preset off time is displayed on the control panel.

## Setting the Timer

This feature is designed to turn the unit on or off after a designated amount of time passes, *one time only*. It does not cycle daily, and needs to be set manually every time.

### Setting the ON time:

1. With the unit turned OFF: Press the **TIMER** button. The panel blinks at 01.
2. Press the **TEMP+** or **TEMP-** button for the desired length of time in hours. (Examples: Setting the time to 02 will turn on the unit after 2 hours. Setting the time to 15 will set the unit to turn on after 15 hours.)
3. Press the **TIMER** button again to activate the setting.



### Setting the OFF time:

1. With the unit turned ON: Press the **TIMER** button. The panel blinks at 01.
2. Press the **TEMP+** or **TEMP-** button for the desired length of time in hours. (Examples: Setting the time to 02 will turn off the unit after 2 hours. Setting the time to 15 will set the unit to turn off after 15 hours.)
3. Press the **TIMER** button again to activate the setting.

*Optional: Press the **TIMER** button again to revert the panel to the temperature display. Your time will remain set.*

**Note:** This timer function would rarely be used in a grow room situation, and is much more useful when the air conditioner is used for common household cooling use.

## SWING (Air Flow)

1. With the unit turned ON: press the **SWING** button and the louver will begin to swing continuously left and right.
2. To stop the louver from swinging, press the **SWING** button again when the louver is in the desired position. The louver will remain in that position.

---

# INSTRUCTION MANUAL

---

## SLEEP Control Function

While in cooling mode, press the **SLEEP** button to set the temperature. Temperature increases 1°C/2°F after one hour (to a maximum increase of 2°C/4°F after 2 hours). Press the **SLEEP** button again to cancel the setting.

## Draining the Inner Water Tank

### Intermittent Drainage

The inner water tank in the air conditioner has a safety switch that controls the water level. When the water level reaches an anticipated height, the "Water Full" indicator lamp lights up. Connect a hose to the drainage outlet located on the backside of the bottom of the unit. Make sure the hose is lower than the unit—you may need to elevate the unit if using a catch pan or reservoir.

### Continuous Drainage

This air conditioner is built to facilitate continuous drainage. When you plan to leave the air conditioner unused for one week or more, remove the rubber plug from the drainage hole at the bottom of the unit. Connect the drainage hose, making sure the hose is lower than the unit.

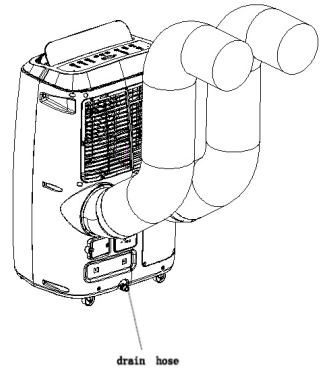

There are two drains, one upper and one lower. The upper drain simply makes it easier and more convenient to attach your drain hose. There are 2 water trays built inside the machine, one is located at the upper drain, the other is at bottom drain. Once the top tray is full, water will flow to the bottom tray when using the bottom drain connection. Only one drain connection is needed to operate the unit in continuous drain mode.

---

## CLEANING THE AIR CONDITIONER

- Before cleaning, be sure to disconnect the unit from any electric supply outlet.
- Clean outer surfaces with a neutral detergent and wet cloth, then wipe with a dry cloth.
- Do not use gasoline or other chemicals to clean the unit.
- Do not immerse the unit in water or spray or pour water directly on it.
- If the air conditioner is damaged, please contact the dealer or repair shop.
- Clean the air filter every two weeks, or whenever it becomes clogged with dust or dirt.
  1. Remove the unit adapter on the back of the unit.
  2. Open the air inlet grille and remove the air filter.
  3. Wash the filter in lukewarm water and neutral detergent.
  4. Let the air filter dry.
  5. Replace the filter in the grille.



# INSTRUCTION MANUAL

## TROUBLESHOOTING

Issue	Possible Causes	Suggested Remedies
<b>Unit does not start when pressing on/off button.</b>	Water full indicator lamp blinks, and water tank is full.	Dump the water out of the water tank.
	Room temperature is lower than the setting temperature (cooling mode).	Reset the temperature.
<b>Unit does not cool the room enough.</b>	Windows or doors are open.	Make sure all the windows and doors are closed.
	There are heat sources inside the room.	Remove the heat sources if possible (other significant heat sources in the room include CO <sub>2</sub> burners, multiple ballasts, etc.).
	Exhaust air hose is not connected or is blocked.	Connect or clean the exhaust air hose.
	Inlet air is too hot.	The maximum temperature for the inlet air is 95°F.
	Temperature setting is too high.	Reset the temperature.
	Air inlet is blocked.	Clean the air inlet. Be sure that the unit's ventilation has been set up properly and that the unit is exhausting to the exterior (outdoors) and is also pulling intake air from the exterior.
	Maximum room size is exceeded.	This unit is recommended for areas up to 800 cubic feet.
<b>Unit is too noisy.</b>	The ground is not level or not flat enough.	Place the unit on a flat, level surface.
	The sound comes from the flowing of the refrigerant inside the air conditioner.	This is normal.
<b>E0 Code</b>	Room temperature sensor failed.	Replace room temperature sensor (the unit can also work without replacement).
<b>E3 Code</b>	Pipe temperature sensor failed (evaporator).	Replace pipe temperature sensor (the unit can also work without replacement).
<b>E2 Code</b>	Water tank is full.	Empty the water tank.

---

# INSTRUCTION MANUAL

---

## FAQs

### Is the unit sealed? Will it draw CO<sub>2</sub> out of my tent?

It is not completely sealed; a small amount of CO<sub>2</sub> and room air will be drawn out through the exhaust.

### Will it work with a controller/thermostat?

Yes. If it is turned on at the time when power is shut off, it will automatically turn back on when power is resupplied.

### What is deadband?

Deadband is the number of degrees during which the compressor will turn off after the set point is reached.

### Why isn't there a dehumidify and cool mode together?

AC and dehumidify are very similar actions. When in cool mode, it will dehumidify; this is the nature of air conditioning. As humid air passes over the cold condenser, moisture condenses. To more effectively dehumidify, the fan speed must be reduced (this is essentially dehumidify mode).

### What about the water that collects?

Water will collect in the reservoir inside the unit. If your unit fills up quickly and frequently, install a drain tube on the back of the unit to one of the two drain plug options, upper or lower. Either drain connection can be used to drain the unit continuously. However, much of the collected water is evaporated and exhausted.

To control humidity and temperature effectively and independently, use an air conditioner and a dehumidifier with a controller like the Autopilot APE4200 or APE4100. For higher amperage devices use Autopilot power expander APCL4X or APCL8X in conjunction with APE4200/100 to program and control your AC and dehumidifier with both day and nighttime set points.

### Can I extend the ducting?

This is not recommended, and will void warranty if done. If ducting must be longer than the 6' of ducting included, a mini split is recommended.

### My TV remote is changing settings on the AC! How do I stop this?

Use tape to cover up the IR sensor to the left of the display on front of unit. If that doesn't work, paint nail polish on the tape. Nail polish effectively blocks IR waves.

---

## SPECIFICATIONS – ACAN1402

Input voltage	115V
Input	10.8A, 1205W
Refrigerant type	R410A/ 16.9 oz
GWP	R410A:2088
Cooling capacity	14000 Btu/h
Design pressure	Hi 550 PSIG / Lo 300 PSIG
Coverage area	Up to 800 cubic feet
Weight	60.0 lbs
Dimension	17.32" L x13.19" W x28.15" H
Warranty	One year



THIS PAGE IS INTENTIONALLY LEFT BLANK.

---

# WARRANTY

---



## LIMITED WARRANTY

Hydrofarm warrants the **ACAN1402** to be free from defects in materials and workmanship. The warranty term is for one year beginning on the date of purchase. Misuse, abuse, or failure to follow instructions is not covered under this warranty. Hydrofarm will, at our discretion, repair or replace the **ACAN1402** covered under this warranty if it is returned to the original place of purchase. To request warranty service, please return the **ACAN1402**, with original sales receipt and original packaging, to your place of purchase. The purchase date is based on your original sales receipt.