

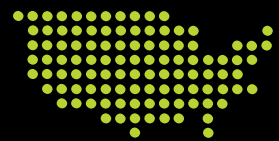

SINOWELL

2018 USA Catalog

Your one-stop shop quality indoor gardening and hydroponic manufacturer



WHY SINOWELL?



FACTORY DIRECT

Order directly from the manufacturer and get the best price



ONE-STOP SHOP

We provide an entire range of indoor gardening and hydroponic products



PROFESSIONAL

The largest indoor gardening and hydroponic manufacturer in China with over 10 years OEM + ODM experience



QUALITY

Our extremely high quality control standards are set in order to guarantee the top quality products from the manufacturer



CUSTOMIZATION

Customer product appearance, functions and packaging based on different needs of our customers



CUSTOMER SERVICE

Competitive product warranty with our USA warehouses to promise reliable, consistent and timely service

WE HAVE WAREHOUSES ON THE WEST COAST AND IN THE MIDWEST TO ENSURE FAST, RELIABLE SHIPPING AND CUSTOMER SERVICE.

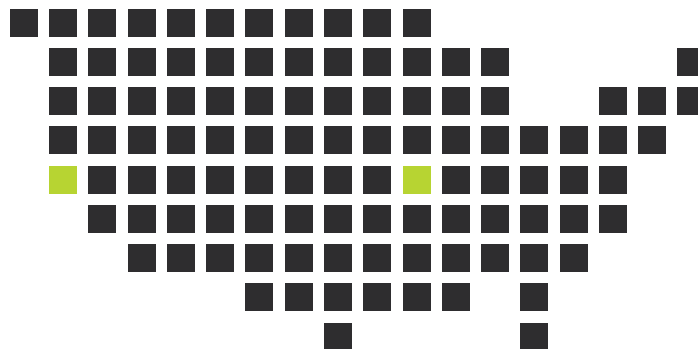

START IMPORTING DIRECTLY FROM CHINA WITH THESE 5 STEPS:



1. SELECT PRODUCTS

Review “Sinowell Price List” and fill in the “Sinowell Order Form” with the desired order quantity. It will automatically calculate the volume, weight, and amount of your order to make it fit either a 20’ or 40’ container



2. CONFIRM PI

We will make a PI (Proforma invoice) for you according to your order. The PI is a legal contract in international business. It includes product details, lead time, shipping methods, trade terms, payment terms and banking information

Product Details

Includes shipping mark, item number, description, quantity, and unit price/package

Lead Time

From 7-25 days upon the receipt of deposit, depending on stock available

Payment Terms

T/T (Telegraphic Transfer), L/C (Letter of Credit), Paypal and Western Union are all acceptable. T/T is the most commonly used method

Trade Term

Usually it's FOB Shanghai, which means the customer needs to pay for the freight from Shanghai to your destination

Banking Information

Include the banking details required to make the international payment

Shipping Methods

Sea, air, or UPS/FedEx/DHL, optional for shipping. Sea freight is the cheapest, but takes longest (14 days from Shanghai to Los Angeles). Air freight and UPS/FedEx/DHL only take 2-6 days, but are more expensive. (This is suitable for high-value goods and sample orders)



3. MAKE PAYMENT

Once the PI is confirmed, you need to transfer a 30% deposit before production, and the remaining balance before delivery. For orders less than \$5,000.00 USD, please transfer the full payment in one transaction to avoid fees from both sides.



4. ARRANGE DELIVERY

When the order is almost ready, you will need to find a shipping forwarder to arrange delivery; or we can arrange it on your behalf. If shipping with UPS/FedEx/DHL, no additional arrangements need to be made.



5. CUSTOMS CLEARANCE

Once the cargo has landed in your country, you can let your shipping forwarder present the documents including the B/L (Bill of Lading), Commercial Invoice, and Packing List to clear customs, and pay the import tariff and other charges. Once the cargo clears customs, the shipping forwarder will arrange delivery to your warehouse.

Note:

- Normally we will Telex Release the B/L, so you only need to present copies of the Commercial Invoice, Packing List, and Telex Released B/L to clear customs.
- For orders sent via UPS/FedEx/DHL, they will clear customs for you, so you don't need to present any documents.

TABLE OF CONTENTS

COVER & INTRODUCTION	1-3	FLUORESCENT LIGHTING LED & GROW LIGHT	30-34	AIR PURIFICATION	56-59
CONTENT	4	- 4Ft/ 2Ft T5 Ho Fluorescent Light Fixture	30	- Carbon Filters Carbon Bed 2 Inch	56
NEW PRODUCT & OUR FACTORY	5-7	- T5 Single Fixture 4'	31	- Carbon Filters Carbon Bed 1.5 Inch	57
DE COMPLETE SYSTEM	8-13	- T5 Single Fixture 2'		- Black Beauty Series Carbon Bed	58
- Flexstar Innovative De System	8	- T5 Ho Fluorescent Lamps		- Economical Type Carbon Filter	59
- 3-Mode Adjustable Reflector With Dimmable Ballast		- Compact Fluorescent Lamp (Blue)	32	- Inline Duct Silencer	
- Flexstar plus innovative DE system	9	- Compact Fluorescent Lamp (Red)		DUCTING / ACCESSORIES	60-62
- Flexstar Plus Stepless Adjusted Mode De Reflector		- HYPERION-720W LED Grow Light Bar	33	- Black-Inside Foil Ducting	60
- Destar-Vertistack-Vertically Integrated De Reflector With Ballast	10	- Led Grow Light Apollo Series	34	- Stainless Steel Duct Clamps	61
- Integrated De Reflector & Ballast	11	- Led Grow Light		- Reducer	62
- Wide Type (Butterfly) Integrated DE Reflector & Ballast (120V/240V/277V)	12	- Led Grow Light Bar		CLIMATE CONTROLS	63
- Pro Remote De System	13	- Full Spectrum 45W Led Grow Light		GARDENING ACCESSORIES	64-80
CMH LIGHTING FIXTURE	14-19	GROW LIGHT REFLECTORS	35-42	- Fabric Pot & Tan Fabric Pot	64
- Ceramic Metal Halide Grow Light Fixture-315W Armour Series	14	- Stackable 3XL Reflector	35	- Transplanting Grow Bag - 1 Gallon & Pro Tan Pot	65
- Ceramic Metal Halide Grow Light Fixture-630W(2X315W) Armour Series	15	- CFL Wing Reflector		- Black & White Plastic Grow Bag	66
- 315W CMH 8" Air-Cooled Fixture	16	- Wing Reflector	36	- Carbon Lined Gym Bag & Bubble Bags	67
- 630W(2X315W) CMH 8" Air-Cooled Fixture		- Gloria 6" Air Cooled-Reflector		- Plastic Saucers	68
- Ceramic Metal Halide Grow Light (CMH)-Classical	17	- Parabolic Reflector	37	- Plastic Pots	
- Double ended 630w CMH fixture	18	- Cool-Tube Air-Cooled Reflector		- Premium Black Square Pot & Square Saucer	
- CMH Explosion-Proof Lamp 630 Watt		- Air-Cooled Reflector	38	- Heavy Duty Saucer	
- Flexstar® Integrated 3-Mode Adjustable Double Ended 945W CMH Fixture-VEGA 95	19	- Double-Ended Wing Reflector		- High Dome Propagator 10" X 20"	69
GROW LIGHT LAMPS	20-25	- Double-Ended Flexible-Wing Reflector	39	- Propagation Tray & Rootbuilder	
- Double Ended HPS Lamp	21	- Compact Double Ended Reflector		- Toolless Assembly Tray Stands	70
- Double Ended MH Lamp		- Double Ended cool-tube reflector	40	- Deluxe Mist & Spray/Wire Cage	71
- 1000W HPS Double-Ended Lamp	20	- Double Ended Stackable 3xl Reflecctor		- Bamboo Stakes	
- PAR-GRO Double Ended HPS Lamp (EUROPEAN PCA)	22	- Compact double ended Reflector		- Pruner	72
- 630W Double Ended CMH Lamp		- Smart De Air-Cooled Reflector	41	- Trowel & Transplanter & Pruning Saw	73
- Philips Master CVolor CDM-T Elite 315W	23	- Double Ended Cool-Tube		- Seedling Heat Mat & Thermostat	74
- PAR-GRO CMH Lamp 315W (EUROPEAN PCA)		- Double Ended Medium	42	- Green Plastic Coated Plant Stake	75
- Super HPS Lamps	24	- Double Air-Cooled Reflector		- Flower Stakes & Grow Cap	
- Super MH Lamps	25	- Lamp & Reflector Cleaning Cloth		- Gardening accessories collection	76-80
- Dual Arc Tube Grow Lamps		- Reflector T Level(Triangle 2 Way Level W/ Magnet)		CLEANROOM ACCESSORIES	81-82
BALLASTS	26-29	LIGHTING ACCESSORIES	43-45	- Powder Free Nitrile Gloves	81
- 315W CMH Ballast	26	GROW TENT	46-47	- ID Card Holder-Vertical Style	
- Dimmable Electronic Ballasts Powerlux Line	27	- US Standard Grow Tent	46	- Plastic Shoe Cover (100/Pack)	
- 120-240V / 277V Fan-Cooled Dimmable Electronic Ballast	28	- GrowHub Series	47	- Non-Woven Fabric Shoe Cover (30/Pack)	
- 8000W 8-Light Hid Master Lighting Relay Controller(Plastic) With Trigger Cord	29	TIMER & METER & PLANT LIGHT ANALYZER	48-50	- Shoe Cover Dispenser	
- Electronic Ballast 1000W-347V		CLIMATE CONTROL PRODUCTS	51	- Clean Room Body Suit	82
- Non Fan-Cooled Dimmable Electronic Ballast		FANS / VENTILATION	52-55	AC / DEHUMIDIFY / HUMIDIFY	83
		- Duct Booster Fan	52	- Dehumidifier	83
		- Plastic Fan		- Household Humidifier	
		- In-Line Fan & Variable Fan Speed Control	53	WATER FILTRATION	84
		- Plastic Inline Tube Fan	54	PUMP & IRRIGATION	85
		- Mixed Flow Fan		WATER CHILLER	86
		- Floor Fan & Clip Fan	55	RO SYSTEM	87-88

NEW PRODUCTS

FLEXSTAR PLUS® STEPLESS ADJUSTED MODE DE REFLECTOR

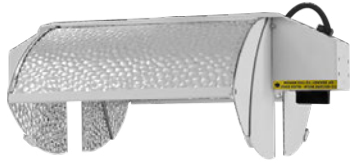

P9

DESTAR-VERTISTACK-VERTICALLY INTEGRATED DE REFLECTOR WITH BALLAST



P10

315W CMH 8" AIR-COOLED FIXTURE



P16

630W(2x315W) CMH 8" AIR-COOLED FIXTURE



P16

DOUBLE ENDED 630W CMH FIXTURE

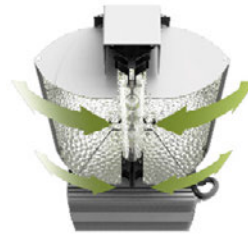

P18

630W DOUBLE ENDED CMH LAMP & CMH EXPLOSION-PROOF LAMP 630 WATT

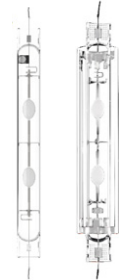

P18

FLEXSTAR® INTEGRATED 3-MODE ADJUSTABLE DE 945W CMH FIXTURE

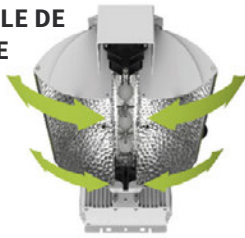

P19

DOUBLED ENDED 945W CMH FIXTURE



P19

CMH LAMP 945W -EUROPEAN PCA



P19

PAR-GRO DOUBLE ENDED HPS LAMP (EUROPEAN PCA)



P22

PAR-GRO CMH LAMP 315W (EUROPEAN PCA)



P23

315W CMH BALLAST



P26

HYPERION-720W LED GROW LIGHT BAR



P33

FLEXWING-DOUBLE ENDED ADJUST-WING REFLECTOR



P39

PYNCH 1/8" HEAVY DUTY ROPE RATCHET



P43

DUPLEX ELECTRICAL OUTLET



P45

120V INTO 240V / 240V INTO 120V ADAPTOR



P45

GROWHUB SERIES



P47

NEW PRODUCTS

16" WALL MOUNT FAN



P55

20" HIGH VELOCITY METAL OSCILLATING STAND FAN



P55

20" FLOOR FAN



P55

TRANSPLANTING GROW BAG - 1 GALLON



P64

HEAVY DUTY SAUCER



P68

TOOLLESS ASSEMBLY TRAY STANDS



P70

WIRE CAGE



P71

BAMBOO STAKES

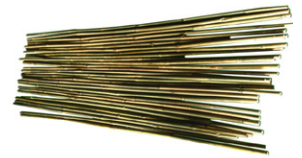

P71

BONSAI SHEARS 1.5" STRAIGHT BLADES



P72

BONSAI SHEARS 2.5" STRAIGHT BLADES



P72

PRUNING SHEAR STEEL BLADE HAND PRUNER (CURVED BLADE SCISSORS)



P72

GROW CAP



P75

4" & 6" ROCK WOOL



P75

ELECTROMAGNETIC AIR PUMP



P84

SUBMERSIBLE WATER PUMP



P84

AIR PUMP



P85

PUMPLESS RO SYSTEM WITH STANDARD/NEUTRAL CONFIGURATION



P87

HIGH REJECTION RO MEMBRANE



P87

PP SEDIMENT FILTER



P88

GAC- GRANULAR ACTIVATED CARBON FILTER



P88

OUR FACTORY



DE COMPLETE SYSTEM

FLEXSTAR® INNOVATIVE DE SYSTEM

3-MODE ADJUSTABLE REFLECTOR WITH DIMMABLE BALLAST

SINOWELL is committed to delivering the best indoor lighting solution to our customers. The Flexstar allows growers to create ideal lighting conditions across all stages of plant growth for increased vitality, health and yield. It is the first reflector on the market that can be adjusted to control the area of light spread. The Flexstar's unique design boosts the power and efficiency while increasing your grow area and yield.

- A 3-Mode adjustable function, by switching these models, beam angle and light spread area can be easily adjusted for different usage
- Patented design only offered by SINOWELL
- Vega embossed aluminum; 95% reflective
- Hammered surface design enhances the diffuse reflectance and ensures uniform light output
- 10 ft power cord for flexible positioning

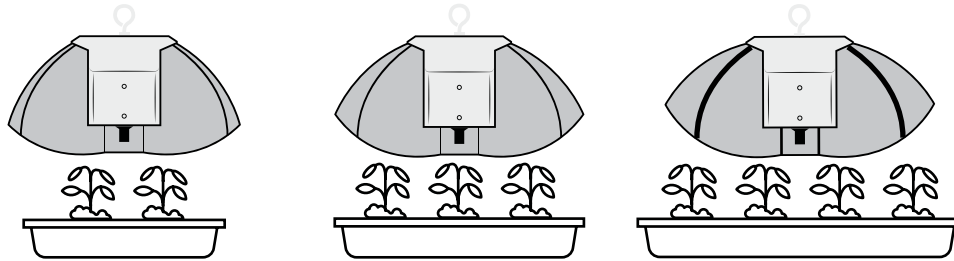
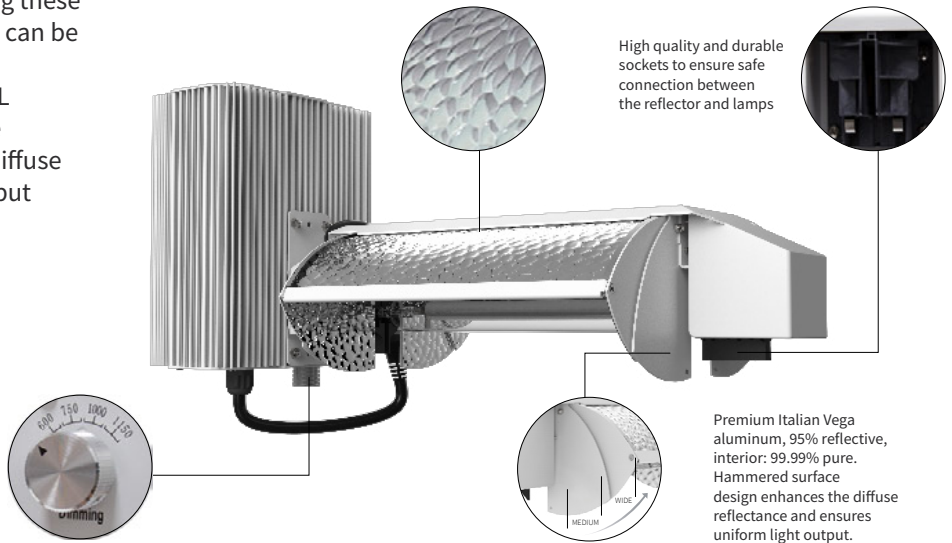

Narrow

Medium

Wide

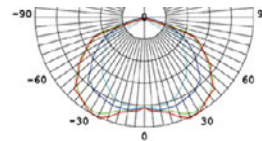
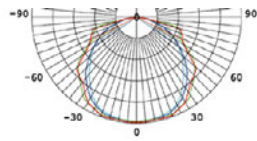
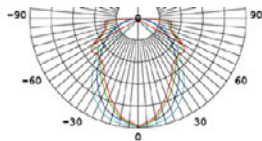

The lamp is not included in this system.



PROPRIETARY DESIGN
PATENT NUMBER
9,810,400



3-YEAR WARRANTY



DOUBLE ENDED



Flexstar - white finish

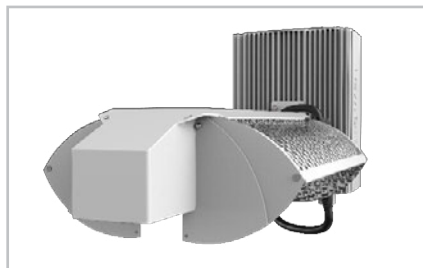

Horizontal style

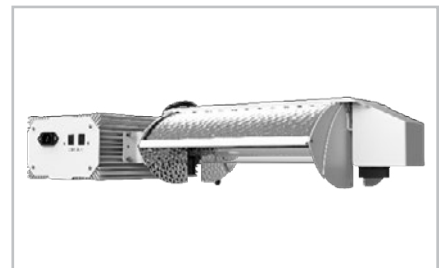

DESCRIPTION	ORDER CODE	REFLECTIVE MATERIAL	PACKAGING DIMENSIONS	CASE QTY
FLEXSTAR® 3-MODE ADJUSTABLE DE SYSTEM 1000W 120-240V	303833-120240	95% REFLECTIVE VEGA ALUMINUM	23.6"(L) x 10.6"(W) x 12.6"(H)	1
FLEXSTAR® 3-MODE ADJUSTABLE DE SYSTEM 1000W 240-277V	303833-240277	95% REFLECTIVE VEGA ALUMINUM	23.6"(L) x 10.6"(W) x 12.6"(H)	1

FLEXSTAR PLUS® INNOVATIVE DE SYSTEM

STEPLESS ADJUSTED MODE DE REFLECTOR & BALLAST

- Stepless adjustable function, by switching these models, beam angle and light spread area can be easily adjusted for different usage
- Patented design only offered by SINOWELL
- Vega embossed aluminum; 95% reflective
- Hammered surface design enhances the diffuse reflectance and ensures uniform light output



The lamp is not included in this system.



3-MODES STEPLESS ADJUSTMENT



Intertek



PATENT NUMBER
9,810,400



3-YEAR WARRANTY



DOUBLE ENDED

DESCRIPTION	ORDER CODE	REFLECTIVE MATERIAL	PACKAGING DIMENSIONS	CASE QTY
FLEXSTAR PLUS® INTEGRATED STEPLESS ADJUSTED MODE DE REFLECTOR & BALLAST 1000W 120-240V (ITALIA VEGA, 95% REFLECTIVE ALUMINUM)	303933-120240	95% REFLECTIVE VEGA ALUMINUM	26.8"(L) x 13.6"(W) x 8.7"(H)	1
FLEXSTAR PLUS® INTEGRATED STEPLESS ADJUSTED MODE DE REFLECTOR & BALLAST 1000W 240-277V (ITALIA VEGA, 95% REFLECTIVE ALUMINUM)	303933-240277	95% REFLECTIVE VEGA ALUMINUM	26.8"(L) x 13.6"(W) x 8.7"(H)	1

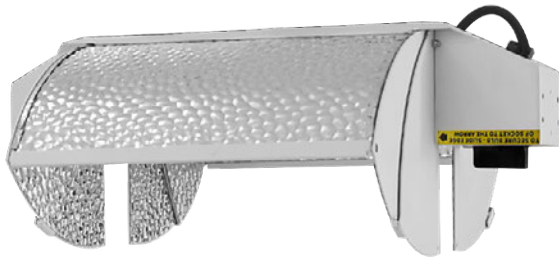

FLEXSTAR PLUS® STEPLESS ADJUSTED MODE DE REFLECTOR



- Stepless adjustable function, by switching these models, beam angle and light spread area can be easily adjusted for different usage
- Patented design only offered by SINOWELL
- Vega embossed aluminum; 95% reflective
- Hammered surface design enhances the diffuse reflectance and ensures uniform light output



Pic 1



Pic 2

The lamp is not included in this system.



Intertek



PATENT NUMBER
9,810,400



3-YEAR WARRANTY



DOUBLE ENDED

DESCRIPTION	ORDER CODE	REFLECTIVE MATERIAL	PACKAGING DIMENSIONS	CASE QTY
FLEXSTAR PLUS® STEPLESS ADJUSTED MODE DE REFLECTOR WITH 15FT POWER CORD (ITALIA VEGA, 95% REFLECTIVE ALUMINUM)	303936	95% REFLECTIVE ALUMINUM	18.9"(L) x 9.8"(W) x 8.3"(H)	1

DESTAR-VERTISTACK-VERTICALLY INTEGRATED DE REFLECTOR WITH BALLAST

NEW
PRODUCT

- New ballast arrangement expands reflected surface by 30%
 - Space-saving design for the brightest, most-efficient grow space
 - No acoustic resonance, just great coverage and penetration
 - Includes full fixture for double-ended 1000W lamps and high-efficiency horticultural reflector
 - Light maintains >95% luminosity after 5,000 hours
 - Output adjustable to 600, 750, 1000 or 1150 Watts
 - Ballast runs on 120-240 V and 240-277 V power sources
 - 10ft power cord for flexible positioning
 - 3-year warranty
- Also available in premium European (VEGA) aluminum with 95% reflectivity

The lamp is not included in this system.





Intertek



3-YEAR WARRANTY



DOUBLE ENDED

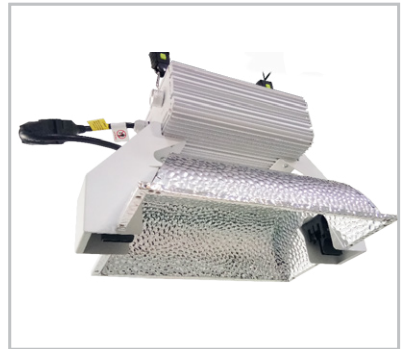

DESCRIPTION	ORDER CODE	REFLECTIVE MATERIAL	PACKAGING DIMENSIONS	CASE QTY
DESTAR-VERTISTACK VERTICALLY INTEGRATED DE REFLECTOR WITH BALLAST 120-240V	303586-120240	HIGHLY REFLECTIVE ALUMINUM	19"(L) x 12.2"(W)x13"(H)	1
DESTAR-VERTISTACK VERTICALLY INTEGRATED DE REFLECTOR WITH BALLAST 240-277V	303586-240277	HIGHLY REFLECTIVE ALUMINUM	19"(L) x 12.2"(W)x13"(H)	1

DE COMPLETE SYSTEM

INTEGRATED DE REFLECTOR & BALLAST

- Full fixture for 1000W double ended lamps, including high-efficiency horticultural reflector
- No acoustic resonance; provides 8% more grow light compared with traditional lamps
- Light maintains >95% luminosity after 5,000 hours
- Output adjustable to 600, 750, 1000 or 1150 Watts
- Ballast can run on 120-240 V and 240-277 V power sources
- Longer 10ft power cord for flexible positioning
- 3-year warranty
- Also available in premium European (VEGA) aluminum, with 95% reflectivity!



Horizontal style

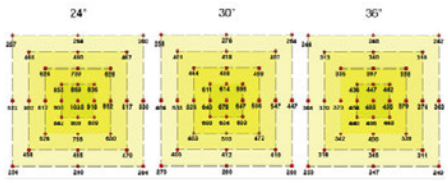

Light spread diagram



The lamp is not included in this system.



3-YEAR WARRANTY



DOUBLE ENDED



DESCRIPTION	ORDER CODE	REFLECTIVE MATERIAL	PACKAGING DIMENSIONS	CASE QTY
INTEGRATED DE REFLECTOR & BALLAST (WITH 120-240V)	303533-120240	HIGHLY REFLECTIVE ALUMINUM	24"(L) x 10"(W)x13"(H)	1
INTEGRATED DE REFLECTOR & BALLAST (WITH 240-277V)	303533-240277	HIGHLY REFLECTIVE ALUMINUM	24"(L) x 10"(W)x13"(H)	1

DESCRIPTION	ORDER CODE	OPERATING VOLTAGE	DIMMING OPTIONS	MAIN FREQUENCY	PACKAGING DIMENSIONS	CASE QTY
1000W DE BALLAST 120-240V	301148-120240	120-240 V	600W/750W 1000W/1150W	50/60HZ	11"(L) x 7"(W) x 5"(H)	1
1000W DE BALLAST 240-277V	301148-240277	240-277 V	600W/750W 1000W/1150W	50/60HZ	11"(L) x 7"(W) x 5"(H)	1

DE COMPLETE SYSTEM

WIDE TYPE (BUTTERFLY) INTEGRATED DE REFLECTOR & BALLAST (120V/240V/277V)

- Full fixture for 1000W double ended lamps, including high-efficiency horticultural reflector
 - No acoustic resonance; provides 8% more grow light compared with traditional lamps
 - Light maintains >95% luminosity after 5,000 hours
 - Output adjustable to 600, 750, 1000 or 1150 Watts
 - Ballast can run on 120-240 V and 240-277 V power sources
 - Longer 10ft power cord for flexible positioning
 - Open design for maximum light output, optimum heat management, and longer lamp life
- Also available in premium European (VEGA) aluminum, with 95% reflectivity!

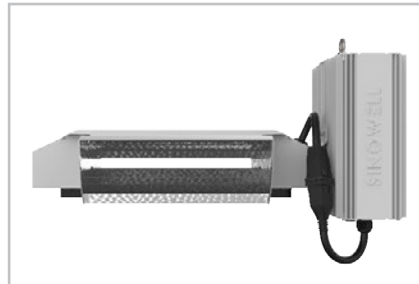
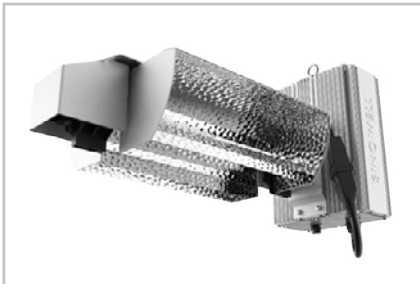
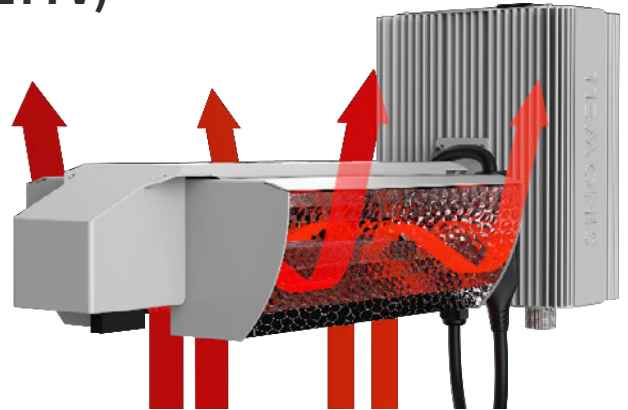

Available in Vertical style



WIDE



WIDE PLUS

The lamp is not included in this system.



3-YEAR WARRANTY

DOUBLE ENDED

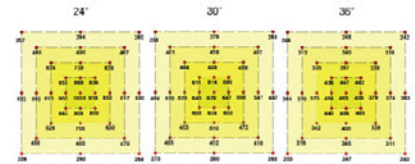

Light spread diagram

DESCRIPTION	ORDER CODE	REFLECTIVE MATERIAL	PACKAGING DIMENSIONS	CASE QTY
WIDE TYPE (BUTTERFLY) 1000W INTEGRATED DE REFLECTOR & BALLAST (WITH 120-240V)	303563-120240	HIGHLY REFLECTIVE ALUMINUM	24"(L) x 10"(W) x 13"(H)	1
WIDE TYPE (BUTTERFLY) 1000W INTEGRATED DE REFLECTOR & BALLAST (WITH 240-277V)	303563-240277	HIGHLY REFLECTIVE ALUMINUM	24"(L) x 10"(W) x 13"(H)	1
WIDE TYPE PLUS (BUTTERFLY) 1000W INTEGRATED DE REFLECTOR & BALLAST (WITH 120-240V)	303563P-120240	HIGHLY REFLECTIVE ALUMINUM	26"(L) x 14"(W) x 13"(H)	1
WIDE TYPE PLUS (BUTTERFLY) 1000W INTEGRATED DE REFLECTOR & BALLAST (WITH 240-277V)	303563P-240277	HIGHLY REFLECTIVE ALUMINUM	26"(L) x 14"(W) x 13"(H)	1

DE COMPLETE SYSTEM

PRO REMOTE DE SYSTEM

- No need for a switchboard
- Easy and safe installation (low voltage device)
- Protected against short circuits
- Double temperature safety feature
- Runs up to 160 ballasts
- Display output as w or %
- Auto-dim at set temperature
- Sunrise/sunset period
- Alarm contacts no/nc
- Longer 16ft power cord for flexible positioning



The lamp is not included in this system.

We use a 95-98% VEGA reflective aluminum that we import from Italy, this pure aluminum layer provides a supreme efficiency and excellent color rendering minimizes light loss and energy wastage. Imported Germany VS Lamp Holder ensures a high degree of reliability and safety.

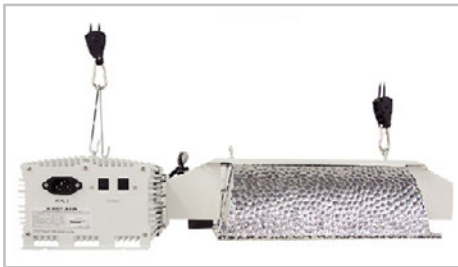

Also available in Horizontal Style

DIMMING OPTION:

GEAR	600	750	825	1000	1150
POWER	600W	750W	825W	1000W	1150W



3-YEAR WARRANTY DOUBLE ENDED



DESCRIPTION	ORDER CODE	OPERATING VOLTAGE	DIMMING OPTIONS	MAIN FREQUENCY	G.W.	PACKAGING DIMENSIONS	CASE QTY
PRO REMOTE 1000W DE SYSTEM 1000W (REFLECTOR & BALLAST) VEGA + VS LAMPHOLDER	301158SV	120-240V 240-277V	600W/750W/ 825W/1000W/ 1150W	50/60HZ	8kg	24"(L) x 11"(W)x12"(H)	1
PRO REMOTE 750W DE SYSTEM 750W (REFLECTOR & BALLAST) VEGA + VS LAMPHOLDER	301161SV	120-240V 240-277V	400W/500W/ 600W/750W/ 825W	50/60HZ	8kg	24"(L) x 11"(W)x12"(H)	1
PRO REMOTE 600W DE SYSTEM 600W (REFLECTOR & BALLAST) VEGA + VS LAMPHOLDER	301159SV	120-240V 240-277V	300W/400W/ 500W/600W/ 660W	50/60HZ	8kg	24"(L) x 11"(W)x12"(H)	1
480V PRO REMOTE 1000W DE SYSTEM 1000W (REFLECTOR&BALLAST) VEGA+VS LAMPHOLDER	301162SV	480V	600W/750W/ 825W/1000W/ 1150W	50/60HZ	8kg	24"(L) x 11"(W)x12"(H)	1

DESCRIPTION	ORDER CODE	INPUT VOLTS	TOTAL NUMBER OF BALLASTS	MAIN FREQUENCY	PACKAGING DIMENSIONS	CASE QTY
MASTER CONTROLLER FOR DIMMABLE ELECTRONIC BALLASTS (600W/750W/1000W)	301158C	5V DC	160 PCS	50/60HZ	4"(L) x 3"(W) x 1"(H)	1





CERAMIC METAL HALIDE GROW LIGHT FIXTURE-315W ARMOUR SERIES

- The 315W ceramic metal halide grow light fixture is a sophisticated all-in-one grow light system designed to optimize yield with a lower operating temperature and lower energy consumption when compared to alternative HIDs.
- The cleverly constructed built-in 315W digital ballast is comprised of the highest quality components to deliver a high intensity & full spectrum output. Because of the low heat output, they are perfect for small spaces like tents, closets or spare rooms.



PROPRIETARY DESIGN

There is no doubt that the most important attribute of any lamp is its yield per watt. Compared with traditional MH or HPS lamps, Sinowell CMH grow lights produce an equivalent amount of light at about half the wattage! The full spectrum properties of our CMH technology can be used for both veg and bloom stages of growth.

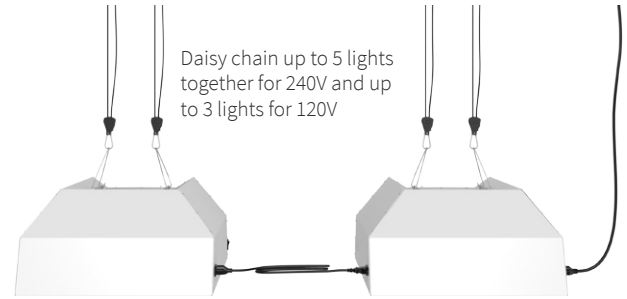
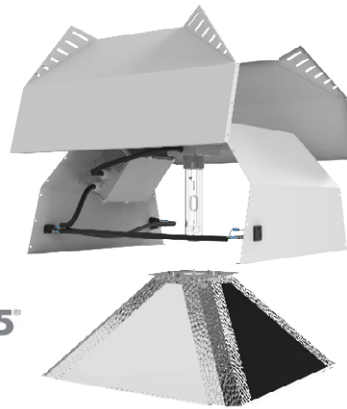
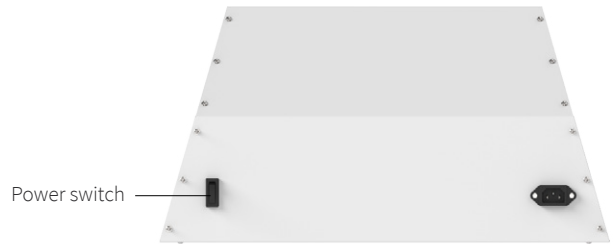

Daisy chain up to 5 lights together for 240V and up to 3 lights for 120V



3-YEAR WARRANTY 315W HORTICULTURAL CDM LAMP



vega95

The lamp is not included in this system.

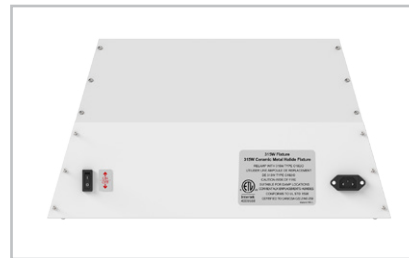
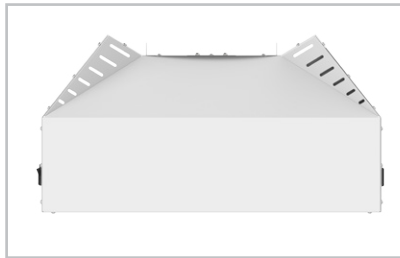

DESCRIPTION	ORDER CODE	REFLECTIVE MATERIAL	PRODUCT DIMENSIONS	PACKAGING DIMENSIONS	N.W.	G.W.	CASE QTY
315W CERAMIC METAL HALIDE GROW LIGHT FIXTURE (REFLECTOR & BALLAST-240V)	303661	95% REFLECTIVE ALUMINUM	20"(L) x 20"(W) x 10"(H)	24"(L) x 21.7"(W) x 12"(H)	8.7 KG	9.25 KG	1
315W CERAMIC METAL HALIDE GROW LIGHT FIXTURE (REFLECTOR & BALLAST-120-240V)	303662	95% REFLECTIVE ALUMINUM	20"(L) x 20"(W) x 10"(H)	24"(L) x 21.7"(W) x 12"(H)	8.7 KG	9.25 KG	1

CERAMIC METAL HALIDE GROW LIGHT FIXTURE-630W (2 x 315W) ARMOUR SERIES



-The 630W ceramic metal halide grow light fixture is a sophisticated all-in-one grow light system designed to optimize yield with a lower operating temperature and lower energy consumption when compared to alternative HIDs.

-The cleverly constructed built-in 630W digital ballast is comprised of the highest quality components to deliver a high intensity & full spectrum output. Because of the low heat output, they are perfect for small spaces like tents, closets or spare rooms.

There is no doubt that the most important attribute of any lamp is its yield per watt. Compared with traditional MH or HPS lamps, Sinowell CMH grow lights produce an equivalent amount of light at about half the wattage! The full spectrum properties of our CMH technology can be used for both veg and bloom stages of growth.



PROPRIETARY DESIGN



3-YEAR WARRANTY

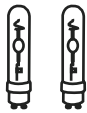

315W HORTICULTURAL CDM LAMP

vega95™

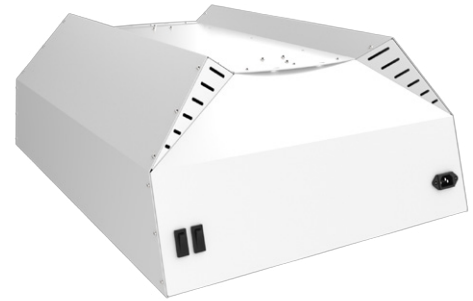
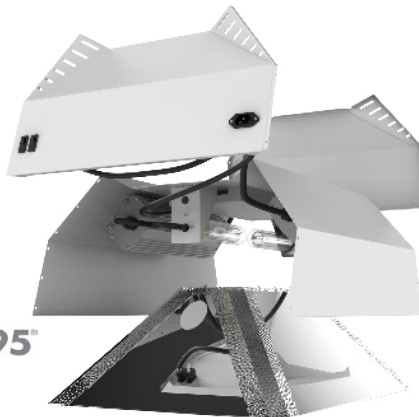

The lamp is not included in this system.

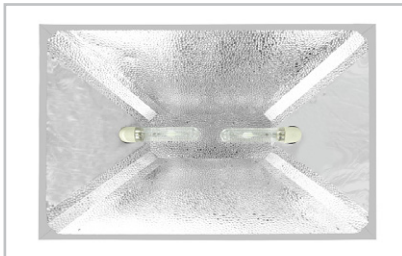

DESCRIPTION	ORDER CODE	REFLECTIVE MATERIAL	PRODUCT DIMENSIONS	PACKAGING DIMENSIONS	N.W.	G.W.	CASE QTY
630W(2 x 315W) CERAMIC METAL HALIDE GROW LIGHTFIXTURE (REFLECTOR & BALLAST-240V)	303663	95% REFLECTIVE ALUMINUM	27"(L) x 20"(W) x 10"(H)	31.5"(L) x 21.7"(W) x 12"(H)	12.5 KG	13.6 KG	1
630W(2 x 315W) CERAMIC METAL HALIDE GROW LIGHTFIXTURE (REFLECTOR & BALLAST120-240V)	303664	95% REFLECTIVE ALUMINUM	27"(L) x 20"(W) x 10"(H)	31.5"(L) x 21.7"(W) x 12"(H)	12.5 KG	13.6 KG	1

315W CMH 8" AIR-COOLED FIXTURE

- MORE LIGHT, LESS POWER
- Allows removal of heat generated by the lamp without cooling the lamp
- Accommodates standard 8" flexible ducting
- 95% reflective Italy textured insert for excellent output
- Greatly improved full color light spectrum out of next generation ceramic metal halide lamps



PROPRIETARY DESIGN



3-YEAR WARRANTY



315W HORTICULTURAL CDM LAMP

95% reflective

DESCRIPTION	ORDER CODE	REFLECTIVE MATERIAL	PRODUCT DIMENSIONS	PACKAGING DIMENSIONS	N.W.	G.W.	CASE QTY
315W CMH 8" AIR-COOLED FIXTURE (REFLECTOR & BALLAST) -240V-(ARMOUR SERIES)	303681	95% REFLECTIVE ALUMINUM	22"(L) x 20"(W) x 10"(H)	28"(L) x 21.7"(W) x 12"(H)	8.9 KG	9.5 KG	1
315W CMH 8" AIR-COOLED FIXTURE (REFLECTOR & BALLAST) -120-240V-(ARMOUR SERIES)	303682	95% REFLECTIVE ALUMINUM	22"(L) x 20"(W) x 10"(H)	28"(L) x 21.7"(W) x 12"(H)	8.9 KG	9.5 KG	1

630W(2x315W) CMH 8" AIR-COOLED FIXTURE

- MORE LIGHT, LESS POWER
- Allows removal of heat generated by the lamp without cooling the lamp
- Accommodates standard 8" flexible ducting
- 95% reflective Italy textured insert for excellent output
- Greatly improved full color light spectrum out of next generation ceramic metal halide lamps

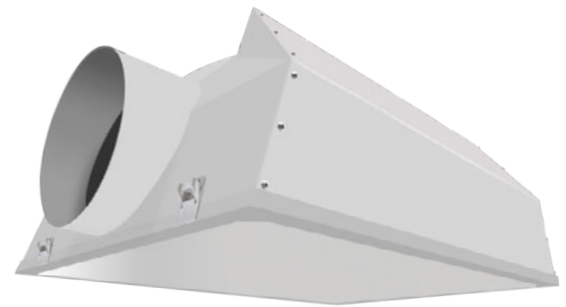

Pic 1

Pic 2

Pic 3

PROPRIETARY DESIGN



3-YEAR WARRANTY

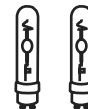

315W HORTICULTURAL CDM LAMP

95% reflective

DESCRIPTION	ORDER CODE	REFLECTIVE MATERIAL	PRODUCT DIMENSIONS	PACKAGING DIMENSIONS	N.W.	G.W.	CASE QTY
630W(2X315W) CMH 8" AIR-COOLED FIXTURE (REFLECTOR & BALLAST) 240V-(ARMOUR SERIES)	303683	95% REFLECTIVE ALUMINUM	29"(L) x 20"(W) x 10"(H)	35"(L) x 21.7"(W) x 12"(H)	13.1 KG	13.9 KG	1
630W (2X315W) CMH 8" AIR-COOLED FIXTURE (REFLECTOR & BALLAST) 120-240V -(ARMOUR SERIES)	303684	95% REFLECTIVE ALUMINUM	29"(L) x 20"(W) x 10"(H)	35"(L) x 21.7"(W) x 12"(H)	13.1 KG	13.9 KG	1

CERAMIC METAL HALIDE GROW LIGHT (CMH)-CLASSIC



3-YEAR WARRANTY

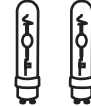

315W HORTICULTURAL CDM LAMP



PATENT NUMBER FOR FLEXSTAR 9,810,400

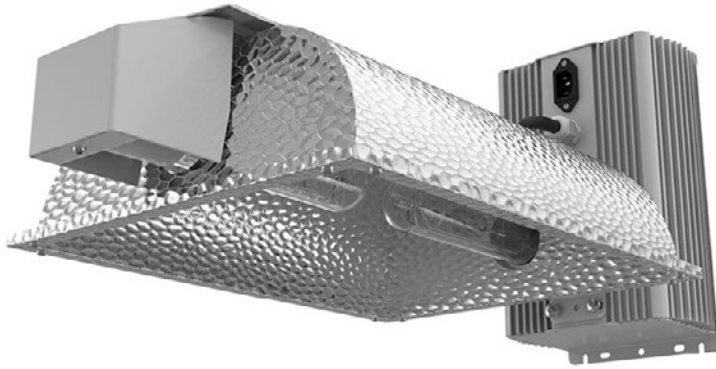

- 630W(2 x 315W) CMH

- This larger one piece fixture combines
- Two light emitting ceramic lamps, covering larger tents and grow spaces
- Longer 16.5 feet power cord for flexible positioning

Also available in: Premium European (Vega) aluminum, 95% reflective

The lamp is not included in this system.

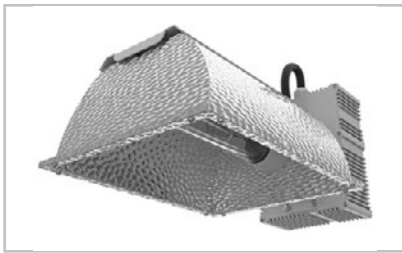

- 315W CMH

- This smaller light fixture perfect for small spaces like small tents, etc
- Longer 16.5 feet power cord for flexible positioning



- FLEXSTAR INTEGRATED 315W CMH REFLECTOR & BALLAST (VEGA 95)



FLEXSTAR 630W(2 x 315W) CMH FIXTURE

DESCRIPTION	ORDER CODE	REFLECTIVE MATERIAL	PACKAGING DIMENSIONS	CASE QTY
315W CMH FIXTURE WITH PGZ18 SOCKET-240V	303631	HIGHLY REFLECTIVE ALUMINUM	23"(L) x 10"(W) x 13"(H)	1
315W CMH FIXTURE WITH PGZ18 SOCKET120-240V	303632	HIGHLY REFLECTIVE ALUMINUM	23"(L) x 10"(W) x 13"(H)	1
630W(2 x 315W) CMH FIXTURE WITH PGZ18 SOCKET-240V	303633	HIGHLY REFLECTIVE ALUMINUM	26"(L) x 15"(W) x 13"(H)	1
630W(2 x 315W) CMH FIXTURE WITH PGZ18 SOCKET120-240V	303634	HIGHLY REFLECTIVE ALUMINUM	26"(L) x 15"(W) x 13"(H)	1

DESCRIPTION	ORDER CODE	REFLECTIVE MATERIAL	PACKAGING DIMENSIONS	CASE QTY
FLEXSTAR 630W (2 x 315W) CMH FIXTURE WITH PGZ18 SOCKET-240V (VEGA)	303733V	95% REFLECTIVE ALUMINUM	23.6"(L) x 10.6"(W) x 12.6"(H)	1
FLEXSTAR 630W (2 x 315W) CMH FIXTURE WITH PGZ18 SOCKET-120-240V(VEGA)	303734V	95% REFLECTIVE ALUMINUM	23.6"(L) x 10.6"(W) x 12.6"(H)	1
FLEXSTAR INTEGRATED 315W CMH REFLECTOR & BALLAST 240V (VEGA 95)	303638	95% REFLECTIVE ALUMINUM	21.6"(L) x 10.6"(W) x 9.5"(H)	1
FLEXSTAR INTEGRATED 315W CMH REFLECTOR & BALLAST 120-240V (VEGA 95)	303639	95% REFLECTIVE ALUMINUM	21.6"(L) x 10.6"(W) x 9.5"(H)	1

CMH LIGHTING FIXTURE

DOUBLE ENDED 630W CMH FIXTURE

- Advanced low frequency square wave technology
- Full horticultural spectrum, high efficiency
- 16 ft power cord for flexible positioning



303768-120240



303766-120240



PATENT NUMBER FOR FLEXSTAR 9,810,400



3-YEAR WARRANTY

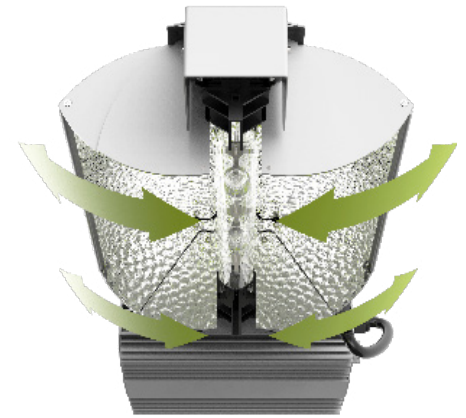

DESCRIPTION	ORDER CODE	REFLECTIVE MATERIAL	PACKAGING DIMENSIONS	CASE QTY
DOUBLE ENDED 630W CMH FIXTURE (REFLECTOR & BALLAST)-120-240V-HORIZONTAL STYLE	303766-120240	HIGHLY REFLECTIVE ALUMINUM	24"(L) x 10"(W) x 13"(H)	1
DOUBLE ENDED 630W CMH FIXTURE(REFLECTOR & BALLAST)-120-240V (VEGA 95)-HORIZONTAL STYLE	303767-120240	95% REFLECTIVE VEGA ALUMINUM	24"(L) x 10"(W) x 13"(H)	1
FlexStar® INTEGRATED 3-MODE ADJUSTABLE DOUBLE ENDED 630W CMH FIXTURE -120-240V (VEGA 95)-HORIZONTAL STYLE	303768-120240	95% REFLECTIVE VEGA ALUMINUM	24"(L) x 10"(W) x 13"(H)	1

630W DOUBLE ENDED CMH LAMP

- Superior color quality, Excellent PPF value
- Crisp white light
- Advanced low frequency square wave technology
- Contains precision glasses for enhanced spectral output
- Generates much less heat than HPS and MH lamps



1-YEAR WARRANTY

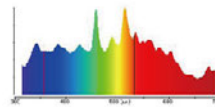

CMH630/942



Pic1



DOUBLE ENDED

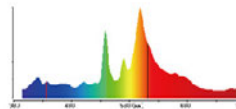

CMH630/930



Pic2

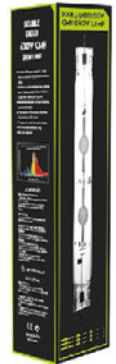

DESCRIPTION	ORDER CODE	INITIAL LUMENS	COLOR TEMP	CRI	LAMP DESIGNATION	CASE QTY	PACKAGING DIMENSIONS
CMH LAMP 630 WATT/942 (EUROPEAN PCA)	302603	60000	4200	95	T32.5	12	18.1"(L) x 12.6"(W) x 8.5"(H)
CMH LAMP 630 WATT/930 (EUROPEAN PCA)	302613	63000	3000	90	T32.5	12	18.1"(L) x 12.6"(W) x 8.5"(H)

CMH EXPLOSION-PROOF LAMP 630 WATT

- Superior color quality, Excellent PPF value
- Advanced low frequency square wave technology
- Contains precision glasses for enhanced spectral output



1-YEAR WARRANTY

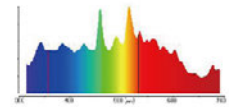

CMH630/942



DOUBLE ENDED

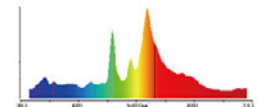

CMH630/930

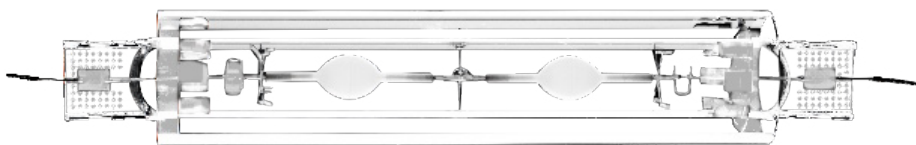

DESCRIPTION	ORDER CODE	INITIAL LUMENS	COLOR TEMP	CRI	LAMP DESIGNATION	CASE QTY	PACKAGING DIMENSIONS
CMH EXPLOSION-PROOF LAMP 630 W/942(EUROPEAN PCA)	302803	60000	4200	95	T32.5	6	17.1"(L) x 12.6"(W) x 9.0"(H)
CMH EXPLOSION-PROOF LAMP 630 W/930(EUROPEAN PCA)	302813	63000	3000	90	T32.5	6	17.1"(L) x 12.6"(W) x 9.0"(H)

CMH LIGHTING FIXTURE

FLEXSTAR® INTEGRATED 3-MODE ADJUSTABLE DOUBLED ENDED 945W CMH FIXTURE - VEGA 95

- Advanced low frequency square wave technology
- Energy efficient and low heat operation
- 3-year warranty
- 10 foot power cord for flexible positioning



PATENT NUMBER FOR FLEXSTAR 9,810,400



3-YEAR WARRANTY

vega95™

The lamp is not included in this system.



DESCRIPTION	ORDER CODE	REFLECTIVE MATERIAL	PACKAGING DIMENSIONS	CASE QTY
FLEXSTAR® INTEGRATED 3-MODE ADJUSTABLE DOUBLED ENDED 945W CMH FIXTURE - 240V ONLY (VEGA 95)	303788-240	HIGHLY REFLECTIVE ALUMINUM	24"(L) x 10"(W) x 13"(H)	1

DOUBLED ENDED 945W CMH FIXTURE (REFLECTOR & BALLAST)

- Advanced low frequency square wave technology
- Energy efficient and low heat operation
- 3-year warranty
- 10 foot power cord for flexible positioning



3-YEAR WARRANTY



The lamp is not included in this system.

DESCRIPTION	ORDER CODE	REFLECTIVE MATERIAL	PACKAGING DIMENSIONS	CASE QTY
DOUBLED ENDED 945W CMH FIXTURE (REFLECTOR & BALLAST)- 240V ONLY	303796-240	HIGHLY REFLECTIVE ALUMINUM	24"(L) x 10"(W) x 13"(H)	1

CMH LAMP 945W -EUROPEAN PCA

- European PCA (Polycrystalline Alumina) lamp imported from Holland
- Full spectrum light output
- Excellent PPF value
- Energy efficient and low heat operation
- Reliable 10,000+ hour lamp life



1-YEAR WARRANTY



DOUBLE ENDED

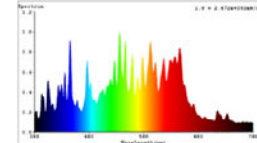
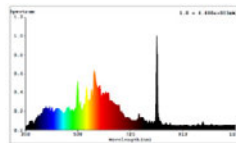

DESCRIPTION	ORDER CODE	INITIAL LUMENS	COLOR TEMP	CRI	LAMP DESIGNATION	CASE QTY	PACKAGING DIMENSIONS
CMH LAMP 945 WATT / 942 (EUROPEAN PCA)	302703	100000	4200	90+	T32.5	12	18.1"(L) x 12.6"(W) x 8.5"(H)
CMH LAMP 945 WATT / 930 (EUROPEAN PCA)	302713	100000	3100	90+	T32.5	12	18.1"(L) x 12.6"(W) x 8.5"(H)

GROW LIGHT LAMPS

DOUBLE ENDED HPS LAMP

- Provides 35% more available energy than the standard HPS lamp
- Specifically designed for high frequency electronic ballasts
- The absence of frame wire eliminates any shadows in the beam
- The jacket is made from quartz glass
- Do not handle with bare hands

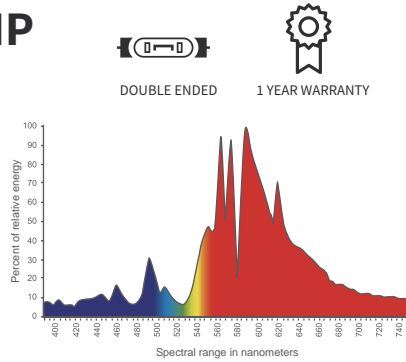

Pic1



Pic2

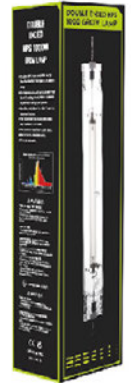

DESCRIPTION	ORDER CODE	INITIAL LUMENS	COLOR TEMP	CRI	RATED LIFE	CASE QTY	PACKAGING DIMENSIONS
DOUBLE ENDED HPS LAMP 600W	302115	86000	2100	30	10000 HRS	12	18.1"(L) x 12.6"(W) x 8.5"(H)
DOUBLE ENDED HPS LAMP 750W	302116	102000	2100	30	10000 HRS	12	18.1"(L) x 12.6"(W) x 8.5"(H)
DOUBLE ENDED HPS LAMP 1000W	302114	151000	2100	30	10000 HRS	12	18.1"(L) x 12.6"(W) x 8.5"(H)

DOUBLE ENDED MH LAMP

- This optimized spectrum metal halide grow lamp allows you to stretch your growing season to 365 days a year, Fine-tune your lighting system to provide optimum spectral energy levels that promote vigorous plant growth
- Optimized spectrum metal halide grow lamps provide high initial and maintained lumen output with optimum spectral energy required for vegetative growth

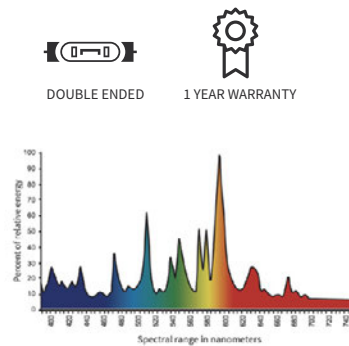

Pic1



Pic2



DESCRIPTION	ORDER CODE	INITIAL LUMENS	COLOR TEMP	CRI	LAMP DESIGNATION	PACKAGING DIMENSIONS	CASE QTY
DOUBLE ENDED MH LAMP 1000W	302125	100000	4000	65	T32	16.7"(L) x 12.0"(W) x 10.4"(H)	12
DOUBLE ENDED MH LAMP 600W	302126	60000	4000	65	T32	17.1"(L) x 11.6"(W) x 8.7"(H)	12

GROW LIGHT LAMPS

AUWL 1000W HPS DOUBLE-ENDED LAMP

DESCRIPTION:

- High pressure sodium lamp for plant growth
- Spectral distribution optimized for photosynthesis efficiency
- High red light ratio and blue output for healthy plant growth and robustness
- Superior μmol output within the PAR spectral range (Photosynthesis Active Radiation) Economic (long average life, high μmol output, low energy consumption)
- Easy lamp change

APPLICATIONS:

Efficient growth lighting in professional greenhouses.

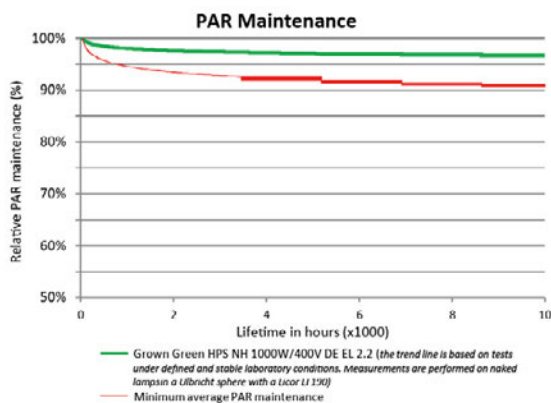
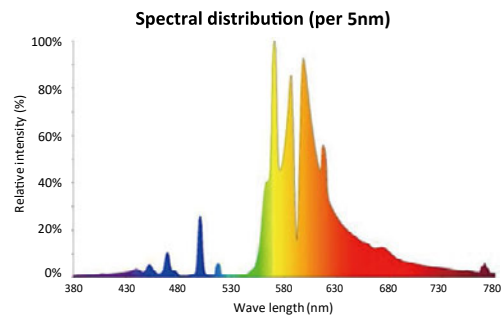

1-YEAR WARRANTY



DOUBLE ENDED



Double-ended lamp is ideal for cultivation with a highest light demand, with the highest output of PAR light (2100 $\mu\text{mol/s}$) to promote photosynthesis – plus high proportions of red light for good plant development, and blue light for a robust, compact plant structure.

1000W HPS Double-Ended Lamps bring the latest in lamp technology to the indoor garden. These lamps significantly increase light intensity and PAR light production compared to single-ended lamps, while consuming the same amount of energy. DEs combine long life with high PAR light output, making them the preferred lamp for professionals worldwide. Ideal for cultivation with high light demands High proportions of red and blue light guarantee efficient photosynthesis

- Highest output of PAR light (2100 $\mu\text{mol/s}$) promotes photosynthesis
- Quartz glass outer jacket for superior optical quality
- Lamp design eliminates shadowing from arctube support
- Lots of red light for more photosynthesis and good plant development
- Blue light for a robust, compact plant structure
- Designed for use with Sinowell high frequency DE fixtures & ballasts

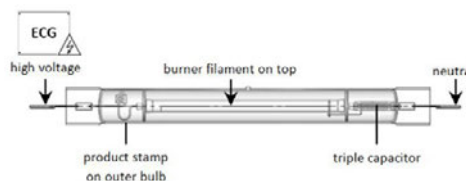

LIFETIME	CONTROL GEAR	BASE	LAMP CONTOUR	LAMP TYPE
10000 H	1000W ELECTRONIC/ 100-150 KHZ	CABLES	TUBULAR	CLEAR

LAMP WATTAGE	LAMP CURRENT	LAMP VOLTAGE	IGNITION VOLTAGE	PAR
1000W	4,8A	230V	3,2KV (PEAK TO EARTH)	2100 $\mu\text{MOL/S}$

DESCRIPTION	ORDER CODE	PAR RATING OUTPUT	RATED AVG LIFE HRS	CORRELATED COLOR TEMP	CASE QTY
AUWL 1000W HPS DE LAMP	302118	2100 $\mu\text{MOL/S}$	10,000	2100K	1

GROW LIGHT LAMPS

PAR-GRO DOUBLE ENDED HPS LAMP (EUROPEAN PCA)



DOUBLE ENDED



1 YEAR WARRANTY



- European PCA (Polycrystalline Alumina) imported from Holland
- Provides 35% more available energy than the standard HPS lamp
- Specifically designed for high frequency electronic ballasts
- The absence of frame wire eliminates any shadows in the beam
- For horizontal burning only
- The jacket is made from quartz glass
- Do not handle with bare hands

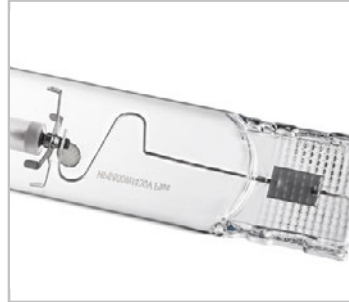

600W detail

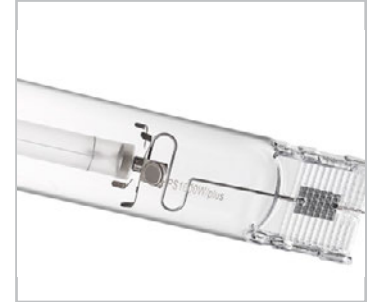

1000W detail

Spectrum

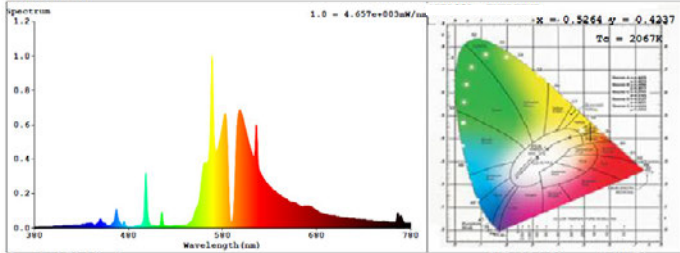

600W spectral distribution

Spectrum

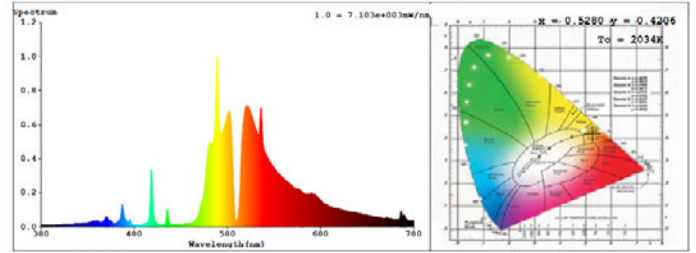

1000W spectral distribution



PAR-GRO DOUBLE ENDED HPS LAMP 1000W (EUROPEAN PCA)



PAR-GRO DOUBLE ENDED HPS LAMP 600W (EUROPEAN PCA)

DESCRIPTION	ORDER CODE	INITIAL LUMENS	COLOR TEMP	CRI	RATED LIFE	CASE QTY	PACKAGING DIMENSIONS
PAR-GRO DOUBLE ENDED HPS LAMP 1000W (EUROPEAN PCA)	302164	148000lm	2100K	30	10000 HRS	12	2.4"(L) x 3.5"(W) x 15.7"(H)
PAR-GRO DOUBLE ENDED HPS LAMP 600W (EUROPEAN PCA)	302165	86000lm	2100K	30	10000 HRS	12	2.4"(L) x 3.5"(W) x 15.7"(H)

GROW LIGHT LAMPS

PHILIPS MASTER COLOR CDM-T ELITE 315W



- The PHILIPS master color elite MW system offers an unrivalled level of light quality and performance
- The lamp's sparkling white light creates a natural ambience and really brings out the best in all different types of colors
- In addition, the high efficiency of the lamp and ballast together means reduced energy use and a lower cost of ownership compared to a 400W metal halide HID system
- Very high 1.95 PPF per second, high 92 CRI, 33,000 initial lumens
- High 90% lumen maintenance at 8,000 hr
- High 85% PPF maintenance at 20,000 hr

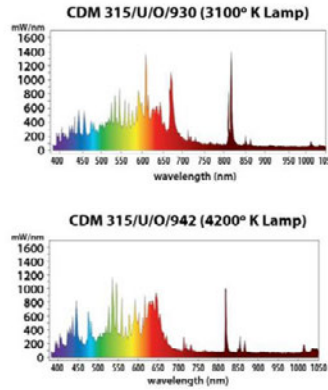
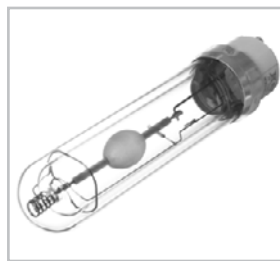

DESCRIPTION	ORDER CODE	BASE	GLASS SIZE	APPROX INITIAL LUMENS	RATED AVG LIFE HRS
PHILIPS GREEN POWER MASTER COLOR CDM LAMP 315 WATT ELITE MW 3100K(FULL SPECTRUM)	302303P	PGZX18	T-12	33,000	20,000
PHILIPS GREEN POWER MASTER COLOR CDM LAMP 315 WATT ELITE MW 4200K(FULL SPECTRUM)	302313P	PGZX18	T-12	33,000	20,000

PAR-GRO CMH LAMP 315W (EUROPEAN PCA)



1-YEAR WARRANTY

- Qualified European PCA (Polycrystalline Alumina) imported from Holland
- Superior color quality
- Excellent PPF value
- Crisp white light
- Advanced low frequency square wave technology
- Energy efficient, High PAR value
- Reduced operating heat
- Increases plant resin production
- Rated life span 10000 hours



European Elliptical PCA
302303 302313

European Elliptical PCA Provides Enhanced Lumen Output and Optimized Spectrum



302353 302363

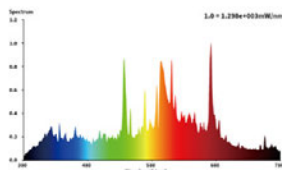

3100K

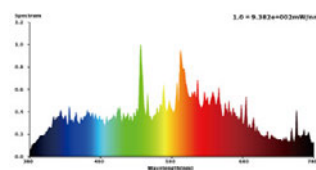

4200K

DESCRIPTION	ORDER CODE	INITIAL LUMENS	COLOR TEMP	CRI	LAMP DESIGNATION	CASE QTY	PACKAGING DIMENSIONS
PAR-GRO CMH LAMP 315W 4200K (VEG) (EUROPEAN PCA)	302303	33000	4200	95	T38	12	18.1"(L) x 9.5"(W) x 10.5"(H)
PAR-GRO CMH LAMP 315W 3100K (FLOWER) (EUROPEAN PCA)	302313	32500	3100	90	T38	12	18.1"(L) x 9.5"(W) x 10.5"(H)
CMH LAMP 315 WATT PGZ18/942	302353	33000	4200	95	T38	12	18.1"(L) x 9.5"(W) x 10.5"(H)
CMH LAMP 315 WATT PGZ18/930	302363	32500	3100	90	T38	12	18.1"(L) x 9.5"(W) x 10.5"(H)

GROW LIGHT LAMPS

SUPER HPS LAMPS

- This Super HPS grow lamp allows you to stretch your growing season to 365 days a year, Fine-tune your lighting system to provide optimum spectral energy levels that promote vigorous plant growth
- Super HPS grow lamps provide up to 15% more available energy for plant growth than the standard high pressure sodium lamp
- Super HPS grow lamp's enhanced spectral energy distribution is designed to grow a wider variety of plants

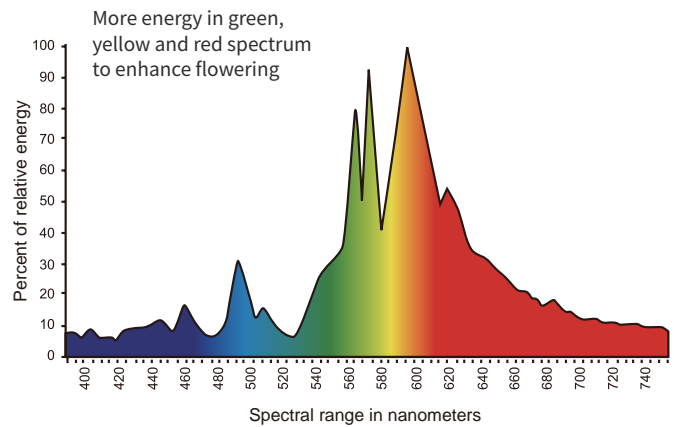

250W



400W



600W



1000W



DESCRIPTION	ORDER CODE	INITIAL LUMENS	COLOR TEMP	CRI	GLASS SIZE	CASE QTY	PACKAGING DIMENSIONS
SUPER HPS 250W	302101	32000	2100	24	T46	25	11.4"(L) x 11.4"(W) x 12.2"(H)
SUPER HPS 400W	302102	55000	2100	24	T46	25	11.4"(L) x 11.4"(W) x 12.2"(H)
SUPER HPS 600W	302103	90000	2100	22	T46	25	11.4"(L) x 11.4"(W) x 12.2"(H)
SUPER HPS 1000W	302104	140000	2100	25	ET25	12	13.2"(L) x 10.3"(W) x 17.4"(H)

GROW LIGHT LAMPS

GROW MH LAMPS

OPTIMIZED FOR ELECTRONIC BALLASTS, WORKS PERFECTLY WITH SINOWELL BALLASTS

- This Optimized Spectrum Metal Halide Grow Lamp allows you to stretch your growing season to 365 days a year
- Fine-tune your lighting system to provide optimum spectral energy levels that promote vigorous plant growth
- Optimized Spectrum Metal Halide Grow Lamps provide high initial and maintained lumen output with optimum spectral energy required for vegetative growth

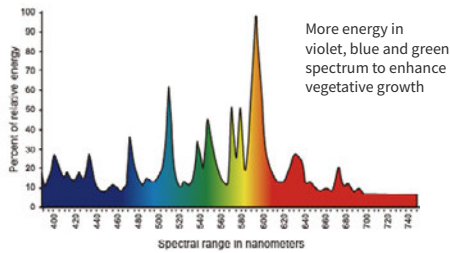

DESCRIPTION	ORDER CODE	INITIAL LUMENS	COLOR TEMP	CRI	GLASS SIZE	CASE QTY	PACKAGING DIMENSIONS
GROW METAL HALIDE 250W/HOR	302201	21000	4200	80	T46	25	11.4"(L) x 11.4"(W) x 12.2"(H)
GROW METAL HALIDE 400W/HOR	302202	36000	4200	80	BT63	25	11.4"(L) x 11.4"(W) x 12.2"(H)
GROW MH CONVERSION 600W/HOR	302203	60000	4200	60	TT80	12	13.4"(L) x 13.4"(W) x 12.2"(H)
GROW METAL HALIDE 1000W/HOR	302204	105000	4200	85	TT80	12	13.2"(L) x 10.3"(W) x 17.4"(H)

PREMIUM HPS LAMP 1000W

- Provides 34% more available energy than the standard high pressure sodium lamp
- Deliver an optimized spectrum and high level of Photosynthetic Active Radiation to promote healthy plant growth
- Provide exceptional performance on both magnetic and electronic ballasts

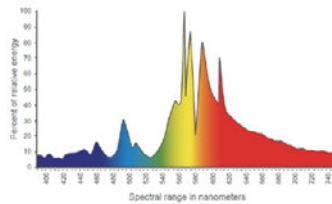

DESCRIPTION	ORDER CODE	INITIAL LUMENS	COLOR TEMP	CRI	GLASS SIZE	CASE QTY	PACKAGING DIMENSIONS
PREMIUM HPS LAMP 1000W	302124	150100	2050	23	---	12	13.2"(L) x 10.3"(W) x 17.4"(H)

DUAL ARC TUBE GROW LAMPS

-This Dual Arc Tube HPS & MH Grow Lamp features the extraordinary power of super HPS and the balanced spectrum of Metal Halide Grow Lamp in one lamp. The benefits of Metal Halide and High Pressure Sodium together are vigorous growth, accelerated development, and hearty flowering. This lamp's unmatched energy spectrum provides the optimum light for plant growth through the entire growth cycle. This lamp operates on standard ANSI S52 ballast, for use on 600/1000-Watt High Pressure Sodium systems



DESCRIPTION	ORDER CODE	INITIAL LUMENS	COLOR TEMP	CRI	GLASS SIZE	CASE QTY	PACKAGING DIMENSIONS
DUAL ARC TUBE LAMP 1000W	302301	110000	3000	65	ET25	12	13.2"(L) x 10.3"(W) x 17.4"(H)

DIMMABLE ELECTRONIC BALLASTS

315W CMH BALLAST



- High power factor of 95%
- Crest Factor<1.7
- Short circuit protection
- Open circuit protection
- Ignition failure protection
- Thermal protection
- End of lamp life(EOL) protection
- Case size: 22.79" x 9.29" x 10.67"
- Input: 120-240V/50-60Hz, THD<15%



DESCRIPTION	ORDER CODE	VOLTAGE	FREQUENCY	POWER (W)	REFRIGERATING CAPACITY	PACKAGE	N.W./G.W.	Case QTY
315W CMH BALLAST 120-240V	303636	120-240 V	50~60 HZ	315W	315W	1	1.76KG/2KG	2
315W CMH BALLAST 240V	303637	240 V	50~60 HZ	315W	315W	1	1.76KG/2KG	2

DIMMABLE ELECTRONIC BALLASTS

DIMMABLE ELECTRONIC BALLASTS-POWERLUX LINE



- Operates from 120v to 240v, 50 hertz to 60 hertz
- High frequency output, 99.9% Power factor
- Soft start technology to extend the lifetime of lamps
- Compatible w/both standard and double ended lamps
- Fully converts between HPS and MH lamps
- Dimmable lighting control-60%, 75%,100%, Super power level
- Short circuit protection; ignition failure protection
- Overheating protection; end-of-lamp-life protection
- 8 ft heavy duty power cord included
- 3 Year warranty, hassle-free

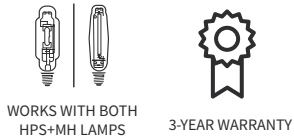
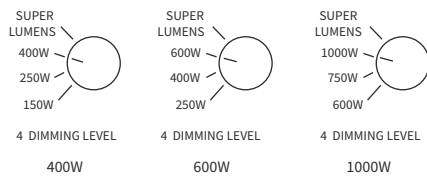

DESCRIPTION	ORDER CODE	OPERATING VOLTAGE	DIMMING OPTIONS	POWER CORD	PRODUCT DIMENSION	PACKAGING DETAIL
DIMMABLE ELECTRONIC BALLASTS 400W-POWERLUX LINE	P301123	120V-240V	150W/250W/400W /SUPER LUMENS	120V 2.4M LONG	14.2"(L) x 4.7"(M) x 3.2"(H)	4PCS/CARTON
DIMMABLE ELECTRONIC BALLASTS 600W-POWERLUX LINE	P301125	120V-240V	250W/400W/600W /SUPER LUMENS	120V 2.4M LONG	14.2"(L) x 4.7"(M) x 3.2"(H)	4PCS/CARTON
DIMMABLE ELECTRONIC BALLASTS 1000W-POWERLUX LINE	P301127	120V-240V	600W/750W/1000W /SUPER LUMENS	120V 2.4M LONG	14.2"(L) x 4.7"(M) x 3.2"(H)	4PCS/CARTON

DIMMABLE ELECTRONIC BALLASTS

120-240V FAN-COOLED DIMMABLE ELECTRONIC BALLAST

- Extremely high frequency, works perfectly with standard lamps and double-ended lamps
- Has "soft start" program to allow multiple ballasts to start at the same time
- Runs on 120 to 240 volt power, 50 hertz or 60 hertz
- Works with both metal halide (MH) and high pressure sodium (HPS) lamps
- External breaker system protects against power surges
- Comes with an 8 ft power cord
- Key electronic components are imported from japan to ensure a longer lifespan
- High quality, 3-year factory warranty



3-YEAR WARRANTY

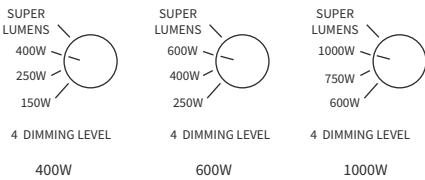

Black is also available



FAN COOLED



RUNS ON 120V OR 240V

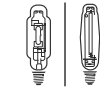

WORKS WITH BOTH HPS+MH LAMPS

DESCRIPTION	ORDER CODE	OPERATING VOLTAGE	DIMMING OPTIONS	POWER CORD	PRODUCT DIMENSION	PACKAGING DETAIL
DIMMABLE ELECTRONIC BALLASTS 400W (WITH FAN)-SPACE GRAY	G301123	100V-265V	150W/250W/400W /SUPER LUMENS	120V 8 FT LONG	10.8"(L) x 4.4"(W) x 3.0"(H)	6PCS/CARTON
DIMMABLE ELECTRONIC BALLASTS 600W (WITH FAN)-SPACE GRAY	G301125	100V-265V	250W/400W/600W /SUPER LUMENS	120V 8 FT LONG	12.4"(L) x 4.4"(W) x 3.0"(H)	6PCS/CARTON
DIMMABLE ELECTRONIC BALLASTS 1000W (WITH FAN)-SPACE GRAY	G301127	100V-265V	600W/750W/1000W /SUPER LUMENS	120V 8 FT LONG	15.4"(L) x 4.4"(W) x 3.0"(H)	6PCS/CARTON

277V FAN-COOLED DIMMABLE ELECTRONIC BALLAST

- Extremely high frequency, works perfectly with standard lamps and double-ended lamps
- Has "soft start" program to allow multiple ballasts to start at the same time
- Runs on 277 volt power, 50 hertz to 60 hertz
- Works with both metal halide (MH) and high pressure sodium (HPS) lamps
- Comes with an 8 ft power cord



3-YEAR WARRANTY



FAN COOLED



RUNS ON 120V OR 240V



WORKS WITH BOTH HPS+MH LAMPS

DESCRIPTION	ORDER CODE	OPERATING VOLTAGE	DIMMING OPTIONS	POWER CORD	PRODUCT DIMENSION	PACKAGING DETAIL	PACKAGING DIMENSION
DIMMABLE ELECTRONIC BALLASTS 1000W BLACK LINE(277V)	301129	277V	50%/75%/100%	277V 8FT LONG	15.4"(L) x 4.4 (W) x 3.0"(H)	4PCS/CARTON	19.2"(L) x 16"(W) x 10.4"(H)

DIMMABLE ELECTRONIC BALLASTS

8000W 8-LIGHT HID MASTER LIGHTING RELAY CONTROLLER(PLASTIC) WITH TRIGGER CORD



- This controller will run eight (8) HID lights at 120/240 Volts
- The only lighting controllers featuring industrial-grade ballast rated relays
- Easy to follow instructions & makes installation simple
- The trigger cable can be plugged into a standard, 24-hour timer or environmental controller premium quality industrial grade relay
- Rated Amperage: 50 Amps

DESCRIPTION	ORDER CODE	VOLTAGE	FREQUENCY	MAXIMUM LIGHTING WATTAGE	OPERATING RANGE	OPERATING HUMIDITY RANGE	MINIMUM RELAY OPERATIONS
8000W 8-LIGHT HID MASTER LIGHTING RELAY CONTROLLER (PLASTIC) WITH TRIGGER CORD-240 VOLT	301135	240 V	50-60HZ	-8000 WATTS / 1000 WATTS PER OUTLET	32-110°F	0-99% RH NON CONDENSING	100,000 AT FULL LOAD

ELECTRONIC BALLAST 1000W-480V



- Extremely high frequency, works perfectly with standard HPS lamps and double-ended HPS lamps
- Has "soft start" program to allow multiple ballasts to start at the same time
- Runs on 480 volt power, 50 hertz or 60 hertz
- Voltage range (-10%/+5%): 432V-505V
- Operation frequency(typical) : 120khz
- Comes with an 8 ft power cord



DESCRIPTION	ORDER CODE	OPERATING VOLTAGE	DIMMING OPTIONS	POWER CORD	PRODUCT DIMENSION	PACKAGING DETAIL	PRODUCT WEIGHT
ELECTRONIC BALLASTS 1000W-(480V)	301131	480V	1000W	480V 8FT LONG WITHOUT PLUG	9.2"(L) x 7.5"(W) x 4.3"(H)	4PCS/CARTON	3.5KG

NON FAN-COOLED DIMMABLE ELECTRONIC BALLAST

- Super lumens - boosts lumen output by 10% at the flip of the switch
- Has "soft-start" program to allow multiple ballasts to start at the same time
- Power factor of 99.9% - Lose fewer watts from the power supply to the lamp
- Runs on 120 to 240 volt power, 50 hertz or 60 hertz
- Works with both MH and HPS lamps
- External breaker system protects against power surges
- Come with an 8 ft power cord



240V POWER CORD SOLD SEPARATELY



3-YEAR WARRANTY



NO FAN COMPLETELY SILENT

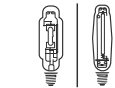

WORKS WITH BOTH HPS+MH LAMPS

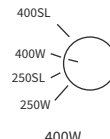

400W

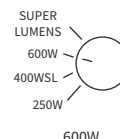

600W

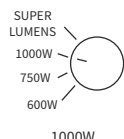

1000W

DESCRIPTION	ORDER CODE	OPERATING VOLTAGE	DIMMING OPTIONS	POWER CORD	PRODUCT DIMENSION	PACKAGING DETAIL
DIMMABLE ELECTRONIC BALLASTS 400W (NO FAN)-BLUE	G301113	120V-240V	250W/250W SL/ 400W/400W SL	120V 8FT Long	11.6"(L) x 4.4"(W) x 3.0"(H)	6PCS/CARTON
DIMMABLE ELECTRONIC BALLASTS 600W (NO FAN)-BLUE	G301115	120V-240V	250W/400W/ 600W/SUPER LUMENS	120V 8FT Long	13.4"(L) x 5.4"(W) x 3.8"(H)	6PCS/CARTON
DIMMABLE ELECTRONIC BALLASTS 1000W (NO FAN)-BLUE	G301117	120V-240V	600W/750W 1000W/SUPER LUMENS	120V 8FT Long	14.6"(L) x 6.6"(W) x 4.0"(H)	6PCS/CARTON

FLUORESCENT LIGHTING

T5 SINGLE STRIP LIGHT FIXTURE WITH REFLECTOR

- 6400K bulb included
- Lightweight and rust free aluminum housing
- Integrated aluminum reflector
- Daisy chain up to 15 fixtures together
- Hanging and flat surface mounting clips included
- Rolling Switch on 6' power cord



1-YEAR WARRANTY



DESCRIPTION	ORDER CODE	POWER	PACKAGING DETAIL	PACKAGING DIMENSION
T5 SINGLE STRIP LIGHT FIXTURE WITH REFLECTOR 2'	307251	24W	1PC/CTN	24"(L) x 5.8"(W) x 1.8"(H)
T5 SINGLE STRIP LIGHT FIXTURE WITH REFLECTOR 4'	307252	54W	1PC/CTN	48"(L) x 5.8"(W) x 1.8"(H)

T5 SINGLE STRIP LIGHT FIXTURE

- 6400K bulb included
- Lightweight and rust free aluminum housing
- Daisy chain up to 15 fixtures together
- Hanging and flat surface mounting clips included
- Rolling Switch on 6' power cord



1-YEAR WARRANTY



DESCRIPTION	ORDER CODE	POWER	PACKAGING DETAIL	PACKAGING DIMENSION
T5 SINGLE STRIP LIGHT FIXTURE WITH REFLECTOR 2'	307261	24W	1PC/CTN	24"(L) x 5.8"(W) x 1.8"(H)
T5 SINGLE STRIP LIGHT FIXTURE WITH REFLECTOR 4'	307262	54W	1PC/CTN	48"(L) x 5.8"(W) x 1.8"(H)

T5 LIGHT FIXTURE STAND

- All stainless steel construction, strong and rust free
- Intuitive pulley hanging system included
- Easy stand setup, no tools required for installation
- Adjust your fixture to any height



1-YEAR WARRANTY



Rope is not included.

DESCRIPTION	ORDER CODE	PACKAGING DIMENSION	PACKAGING DETAIL
T5 LIGHT FIXTURE STAND 2'	307271	54"(L) x 4"(W) x 4"(H)	1PC/CARTON
T5 LIGHT FIXTURE STAND 4'	307272	54"(L) x 4"(W) x 4"(H)	1PC/CARTON

4FT T5 HO FLUORESCENT LIGHT FIXTURE

- Come with top quality lamps
- Highly reflective European aluminum
- UL listed electronic ballast
- 2-year factory warranty
- Runs on 120V/277V volt power
- Comes with premium quality lamps



2-YEAR WARRANTY

DESCRIPTION	ORDER CODE	VOLTAGE FREQUENCY	POWER W	CURRENT A	WEIGHT LBS	CASE QTY	PACKAGING DETAIL
STANDARD T5 GROW LIGHT FIXTURE 4FT 4 TUBE (WITH LAMP)-120V	307211	120V 60HZ	216	1.8	19	1	48.5"(L) x 15.5"(W) x 4.5"(H)
STANDARD T5 GROW LIGHT FIXTURE 4FT 8 TUBE (WITH LAMP)-120V	307212	120V 60HZ	432	3.6	28	1	48.5"(L) x 26"(W) x 4.5"(H)
STANDARD T5 GROW LIGHT FIXTURE 4FT 8 TUBE (WITH LAMP)-277V	307210	277V 60HZ	432	1.6	28	1	48.5"(L) x 26"(W) x 4.5"(H)
STANDARD T5 GROW LIGHT FIXTURE 4FT 8 TUBE (WITH LAMP)-347V	307215	347V 60HZ	432	1.3	28	1	48.5"(L) x 26"(W) x 4.5"(H)
STANDARD T5 GROW LIGHT FIXTURE 4FT 6 TUBE (WITH LAMP)-120V	307225	120V 60HZ	324	2.7	11.5	1	48"(L) x 21.5"(W) x 3.9"(H)

NEW PRODUCT

2FT T5 FLUORESCENT FIXTURE

- Low profile, cool operating, and high performance
- 2 chrome hangers and 8' power cord included
- Powder coated steel housing
- Convenient On/Off switch
- Horizontal and vertical hanging option
- UL listed, 2 years limited warranty
- For seedling starts, house plants, flowers, anything you want to grow indoors



2-YEAR WARRANTY

DESCRIPTION	ORDER CODE	VOLTAGE FREQUENCY	POWER W	CURRENT A	WEIGHT LBS	CASE QTY	PACKAGING DETAIL
T5 FLUORESCENT FIXTURE 2 x 2 (2 x 24W with 6500K LAMP)	307221	120V 60HZ	55.2	0.46	5.5	1	24.4"(L) x 10.8"(W) x 3.9"(H)
T5 FLUORESCENT FIXTURE 2 x 4 (4 x 24W with 6500K LAMP)	307222	120V 60HZ	114	0.95	7.7	1	24.4"(L) x 16.1"(W) x 3.9"(H)
T5 FLUORESCENT FIXTURE 2 x 6 (6 x 24W with 6500K LAMP)	307223	120V 60HZ	144	1.2	12.1	1	24.4"(L) x 21.4"(W) x 3.9"(H)

FLUORESCENT LIGHTING

T5 SINGLE FIXTURE 4'



- 4' single tube with lamp and reflector
 - 6 1/2' long power cord
 - 5000lm
 - 1x54W
- Order code: 307242
Weight: 1.2kg



T5 SINGLE FIXTURE 2'



- 2' tubes with lamps and reflectors
 - 2' extension wire connector(3pcs) and 6 1/2' power cord
 - 20000lm
 - 4x24W
- Order code: 307243
Weight: 2.4kg

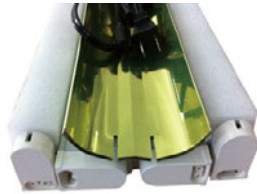

T5 SINGLE FIXTURE 4'



- 4' tubes with lamps and reflectors
 - 2' extension wire connector(3pcs) and 6 1/2' power cord
 - 40000lm
 - 4x54W
- Order code: 307244
Weight: 4.8kg

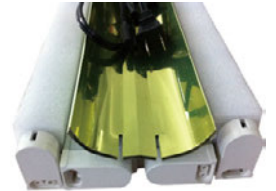

T5 HO FLUORESCENT LAMPS

- High output, long life, super efficient
- Cool spectrum for vegetative growing, warm spectrum for flower production
- Compatible with all SINOWELL T5 fixtures



DESCRIPTION	ORDER CODE	WATTS W	CCT K	AVG.LIFE HRS	LUMEN OUTPUT IM	CASE QTY	PACKAGING DIMENSION
T5 HO FLUORESCENT LAMP 2' 3000K	307233	24	3000	20000	2000	50	12"(L) x 3.8"(W) x 3.8"(H)
T5 HO FLUORESCENT LAMP 2' 6500K	307234	24	6500	20000	2000	50	12"(L) x 3.8"(W) x 3.8"(H)
T5 HO FLUORESCENT LAMP 4' 3000K	307213	54	3000	20000	5000	50	22.3"(L) x 3.8"(W) x 3.8"(H)
T5 HO FLUORESCENT LAMP 4' 6500K	307203	54	6500	20000	5000	50	22.3"(L) x 3.8"(W) x 3.8"(H)

COMPACT FLUORESCENT LAMP (RED)

- Designed for horticulture use
- Full spectrum
- Fits standard E39 mogul base socket
- Cool spectrum for vegetative growing, warm spectrum for flower production
- 6-month warranty



DESCRIPTION	ORDER CODE	WATTS W	VOLTAGE FREQUENCY	CCT K	AVG.LIFE HRS	LUMEN OUTPUT	WEIGHT LBS	PACKAGING DETAIL
COMPACT FLUORESCENT Lamp 150W RED	307105	150	120V/60HZ	2700	10,000	10,200	1.8	15.5"(L) x 5.8"(W) x 5.6"(H)
COMPACT FLUORESCENT Lamp 200W RED	307214	200	120V/60HZ	2700	10,000	13,600	2.7	16.6"(L) x 6.3"(W) x 6.3"(H)
COMPACT FLUORESCENT Lamp 250W RED	307314	250	120V/60HZ	2700	10,000	17,000	3.0	16.6"(L) x 6.3"(W) x 6.3"(H)
COMPACT FLUORESCENT Lamp 300W RED	307414	300	120V/60HZ	2700	10,000	20,400	3.0	16.6"(L) x 6.3"(W) x 6.3"(H)
DUAL (RED + BLUE IN ONE Lamp) 150W	307106	150	120V/60HZ	6500 / 2700	10,000	9,900	1.8	15.5"(L) x 5.8"(W) x 5.6"(H)
DUAL (RED + BLUE IN ONE Lamp) 200W	307206	200	120V/60HZ	6500 / 2700	10,000	13,200	2.7	16.6"(L) x 6.3"(W) x 6.3"(H)
DUAL (RED + BLUE IN ONE Lamp) 250W	307306	250	120V/60HZ	6500 / 2700	10,000	16,500	3.0	16.6"(L) x 6.3"(W) x 6.3"(H)
DUAL (RED + BLUE IN ONE Lamp) 300W	307307	300	120V/60HZ	6500 / 2700	10,000	19,800	3.0	16.6"(L) x 6.3"(W) x 6.3"(H)

COMPACT FLUORESCENT LAMP (BLUE)

- Designed for horticulture use
- Full spectrum
- Fits standard E39 mogul base socket
- Cool spectrum for vegetative growing, warm spectrum for flower production
- 6-month warranty



DESCRIPTION	ORDER CODE	WATTS W	VOLTAGE FREQUENCY	CCT K	AVG.LIF HRS	LUMEN OUTPUT LM	WEIGHT LBS	PACKAGING DETAIL
COMPACT FLUORESCENT Lamp 150W BLUE	307104	150W	120V/60HZ	6500K	10,000	9,450	1.8	15.5"(L) x 5.8"(W) x 5.6"(H)
COMPACT FLUORESCENT Lamp 200W BLUE	307204	200W	120V/60HZ	6500K	10,000	12,600	2.7	16.6"(L) x 6.3"(W) x 6.3"(H)
COMPACT FLUORESCENT Lamp 250W BLUE	307304	250W	120V/60HZ	6500K	10,000	15,750	3.0	16.6"(L) x 6.3"(W) x 6.3"(H)
COMPACT FLUORESCENT Lamp 300W BLUE	307404	300W	120V/60HZ	6500K	10,000	18,900	3.0	16.6"(L) x 6.3"(W) x 6.3"(H)

FLUORESCENT LIGHTING

HYPERION-720W LED GROW LIGHT BAR



- Input Voltage: MeanWell HLG AC100-277V, 305V.
- Spectrum: full spectrum
- Thermal management: passive
- Light distributor: 0-120° (beam angle can be adjust)
- Lifetime: > 100,000hours, Power factor: >93%
- Waterproof: IP65
- LED Grow Light bar is a full-cycle top-lighting solution for commercial horticulture cultivation, with the power to scale from vegetative growth to bloom. For optimal results, we recommend LED deployed in environments with CO2 supplementation between 800-1400 ppm in reproductive growth stage due to high PPFD levels.



3-YEAR WARRANTY

DESCRIPTION	ORDER CODE	INPUT POWER	LIGHT SOURCE	MOUNTING HEIGHT	PPFD	EFFICACY	FIXTURE DIMENSION	PRODUCT NET WEIGHT	N.W./G.W.	MOQ
HYPERION-720W LED GROW LIGHT BAR	307188	720W	HIGH POWER LED	≥ 12" Above Canopy	1082 $\mu\text{mol/s/m}^2$	2.24 $\mu\text{MOL/J}$	47.2" x 47.2"	26.80KG	26.80/30.00KG	50

LED GROW LIGHT BAR



- Widely used in greenhouse cultivation, plant factory, flower breeding, indoor garden, water soluble, pipeline cultivation, farm, pot culture, tissue culture etc, ideal for all phases of plant growth, and works well with water solution culture and soil culture- Environment: -20-40°C, 45%-95% RH
- Product size: 47.2 x 2.2 x 1.4 inch
- Inner carton: 48.8 x 3.2 x 3 inch
- Outer carton: 49.2 x 9.6 x 7.3 inch / 6pcs



DESCRIPTION	ORDER CODE	WORKING CURRENT	FREQUENCY	POWER	LED QTY	LED POWER	LUMEN	SPECTRAL RANGE	LED LIFESPAN
LED GROW LIGHT BAR	307171	590mA	50-60HZ	54-60W	28 PCS	3W	1288LM	410NM-850NM	50000 HOURS

LED GROW LIGHT

225W UFO LED GROW LIGHT



2-YEAR WARRANTY



- Wide voltage range of 100-240V AC
- Dual heat sink design
- 360 degree raised housing lip feature prevents water ingress
- 2-Year warranty on our premium performing 3W LED+700m acurrent components
- Modular design allows for easy repair and maintenance
- Cambered LED panel offers a 150° wide beam angle allowing for a large and symmetrical light spread
- Polycarbonate ABS offers superior strength and heat resistance
- Durable vibration resistant component design

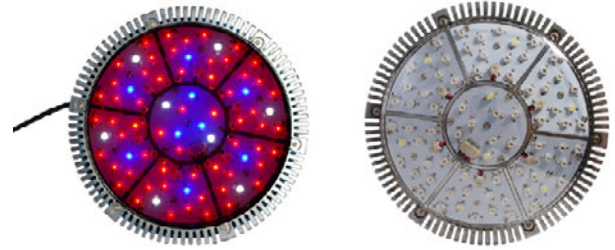

DESCRIPTION	ORDER CODE
225W UFO LED GROW LIGHT	307181

LED GROW LIGHT APOLLO SERIES



2-YEAR WARRANTY



180W



270W



360W



450W



540W



720W



810W



900W

DESCRIPTION	ORDER CODE	LED QTY	INPUT VOLTAGE	NET WEIGHT	SIZE
APOLLO 4 LED GROW LIGHT (MAX POWER 180W)	307161	60PCS x 3W	100-240V	3.7KG	10.6"(L) x 11.14"(W) x 3.35"(H)
APOLLO 6 LED GROW LIGHT (MAX POWER 270W)	307162	90PCS x 3W	100-240V	4.8KG	15.08"(L) x 11.14"(W) x 3.35"(H)
APOLLO 8 LED GROW LIGHT (MAX POWER 360W)	307163	120PCS x 3W	100-240V	6.1KG	19.53"(L) x 11.14"(W) x 3.35"(H)
APOLLO 10 LED GROW LIGHT (MAX POWER 450W)	307164	150PCS x 3W	100-240V	7.4KG	23.97"(L) x 11.14"(W) x 3.36"(H)
APOLLO 12 LED GROW LIGHT (MAX POWER 540W)	307165	180PCS x 3W	100-240V	8.7KG	28.42"(L) x 11.14"(W) x 3.36"(H)
APOLLO 16 LED GROW LIGHT (MAX POWER 720W)	307166	240PCS x 3W	100-240V	11.2KG	37.32"(L) x 11.14"(W) x 3.37"(H)
APOLLO 18 LED GROW LIGHT (MAX POWER 810W)	307167	270PCS x 3W	100-240V	12.7KG	41.77"(L) x 11.14"(W) x 3.37"(H)
APOLLO 20 LED GROW LIGHT (MAX POWER 900W)	307168	300PCS x 3W	100-240V	13.6KG	46.22"(L) x 11.14"(W) x 3.38"(H)

GROW LIGHT REFLECTORS

STACKABLE 3XL REFLECTOR

- Easy set up-only needs 2 minutes
- Uniquely designed plastic corners make the reflector much stronger than other similar products on the market
- 6 packed in a carton - save 80% on shipping
- Optional 2 mogul positions: one for 1000W, another for 400W/600W
- Made from premium highly reflective aluminum
- Separately boxed pre-wired E39 socket, 15' lamp cord and hanging hooks
- To avoid damage, express shipping is not recommended
- The lamp is not included in the system

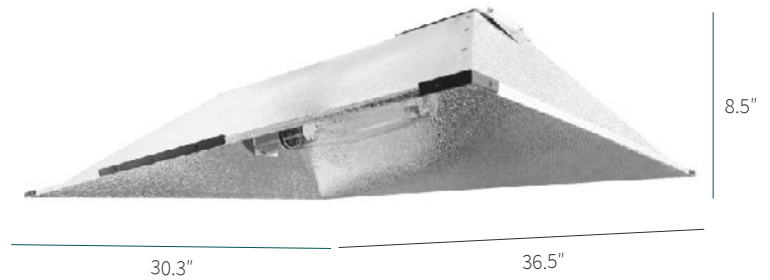

Comes with non-branded label
Customized label available



Pic 1

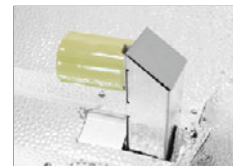

Pic 2



Pic 3

DESCRIPTION	ORDER CODE	REFLECTOR MATERIAL	REFLECTOR SIZE	PACKAGING DIMENSIONS	ACCEPTS	CASE QTY
STACKABLE 3XL REFLECTOR	303511	HIGHLY REFLECTIVE ALUMINUM	36.5"(L) x 30.3"(W) x 8.5"(H)	37"(L) x 31.5"(W) x 12.6"(H)	HPS400W-1000W MH400W-1000W	6

CFL WING REFLECTOR

- Heavy duty mounting bracket
- Rounded corners for safety
- Made from highly reflective textured aluminum for excellent light dispersal without "hot-spots"
- Comes with built-in UL listed socket and 16' lead without lamp
- The lamp is not included in the system
- Incredible value super light weight!

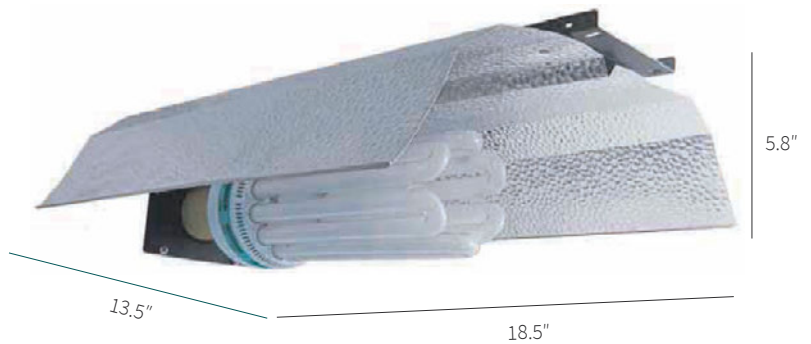

Comes with non-branded label
Customized label available



Pic 1



Pic 2



Pic 3

DESCRIPTION	ORDER CODE	REFLECTOR MATERIAL	REFLECTOR SIZE	PACKAGING DIMENSIONS	ACCEPTS	CASE QTY
CFL WING REFLECTOR	303225	HIGHLY REFLECTIVE ALUMINUM	18.5"(L) x 13.5"(W) x 5.8"(H)	31.8"(L) x 16.5"(W) x 6.0"(H)	CFL WING-300W	6

GROW LIGHT REFLECTORS

WING REFLECTOR

- Heavy duty mounting bracket
- Rounded corners for safety
- Made from highly reflective textured aluminum for excellent light dispersal without "hot-spots"
- Comes with built-in UL listed socket and 15' pre-wired lamp cord
- Lamp is not included in the system
- Incredible value super light weight!

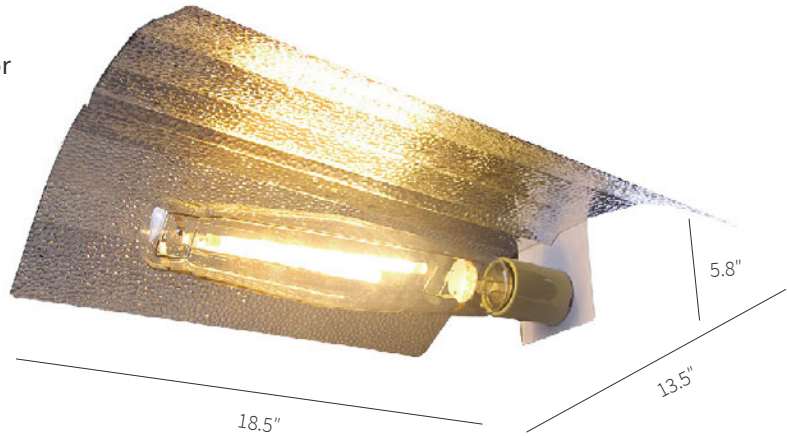

Comes with non-branded label
Customized label available



10-YEAR WARRANTY



DESCRIPTION	ORDER CODE	REFLECTOR MATERIAL	REFLECTOR SIZE	PACKAGING DIMENSIONS	ACCEPTS	CASE QTY
WING REFLECTOR	303205	HIGHLY REFLECTIVE ALUMINUM	18.5"(L) x 13.5"(W) x 5.8"(H)	31.8"(L) x 16.5"(W) x 6.0"(H)	HPS400W-1000W MH400W-1000W	6

GLORIA 6" AIR COOLED-REFLECTOR

- Sealed with slide-in gasketed glass constructed with heavy duty pre-galvanized steel
- Premium highly reflective aluminum used for reflector
- Computer-designed aluminum interior for even light spread
- Comes with built-in socket, 15' pre-wired lamp cord, and hanging hooks
- Lamp is not included in the system



10-YEAR WARRANTY



Comes with non-branded label
Customized label available



DESCRIPTION	ORDER CODE	REFLECTOR MATERIAL	REFLECTOR SIZE	PACKAGING DIMENSIONS	ACCEPTS	CASE QTY
GLORIA 6" AIR-COOLED REFLECTOR	303311	HIGHLY REFLECTIVE ALUMINUM	23.3"(L) x 16.8"(W) x 7.3"(H)	23.7"(L) x 17.7"(W) x 9.5"(H)	HPS400W-1000W MH400W-1000W	1

GROW LIGHT REFLECTORS

PARABOLIC REFLECTOR

- Innovative Design: can be installed vertically or horizontally
- User-friendly, easy installation
- Made from premium highly reflective aluminum
- Comes with built-in UL-certified socket and 15' pre-wired lamp cord
- The lamp is not included in the system



Mode1: Vertical Style



10-YEAR WARRANTY

Comes with non-branded label
Customized label available

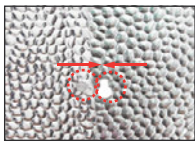

STEP1

Find the button and hole on each panel

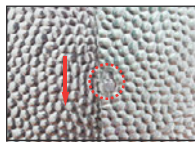

STEP2

Put the button into the wide side of the hole

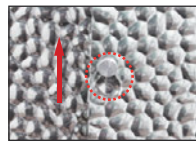

STEP3

Push the button to the narrow side of the hole



Mode2: Horizontal Style

DESCRIPTION	ORDER CODE	REFLECTOR MATERIAL	REFLECTOR SIZE	PACKAGING DIMENSIONS	ACCEPTS	CASE QTY
PARABOLIC REFLECTOR (VERTICAL+HORIZONTAL)-42"	303713	HIGHLY REFLECTIVE ALUMINUM	DIAMETER 42"	—	HPS1000W	6
PARABOLIC REFLECTOR (VERTICAL+HORIZONTAL)-35"	303723	HIGHLY REFLECTIVE ALUMINUM	DIAMETER 35"	—	HPS4000W-600W	6

COOL-TUBE AIR-COOLED REFLECTOR

- Accommodates most lamp types up to 1000W
- Internal and external reflectors included
- External reflector is removable
- Made from premium highly reflective aluminum
- Comes with built-in socket and 15' pre-wired lamp cord
- The lamp is not included in the system
- Cool, compact and efficient

Available in 5" 6" 8"

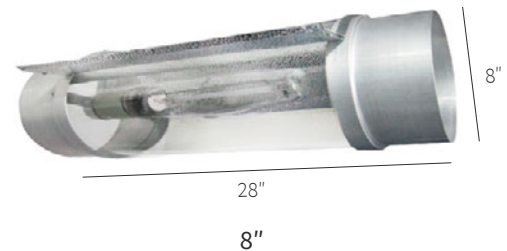
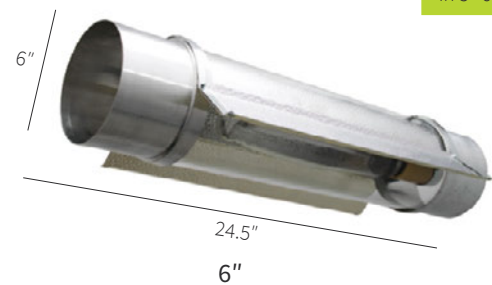

Comes with non-branded label
Customized label available



10-YEAR WARRANTY



Intertek

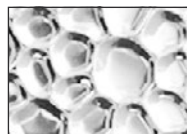

DESCRIPTION	ORDER CODE	REFLECTOR MATERIAL	REFLECTOR SIZE	PACKAGING DIMENSIONS	ACCEPTS	CASE QTY
COOL TUBE 6" AIR-COOLED REFLECTOR	303103	HIGHLY REFLECTIVE ALUMINUM	24.5"(L) x 6"(D)	27.2"(L) x 9.8"(W) x 8.4"(H)	HPS400W-1000W MH400W-1000W	1
COOL TUBE 8" AIR-COOLED REFLECTOR	303113	HIGHLY REFLECTIVE ALUMINUM	28"(L) x 8"(D)	29.5"(L) x 15.8"(W) x 10.8"(H)	HPS400W-1000W MH400W-1000W	1

GROW LIGHT REFLECTORS

AIR-COOLED REFLECTOR

- Completely sealed with gasketed glass for effective heat isolation and cooling
- Equipped with safety cable for safe and easy maintenance
- Made from premium highly reflective aluminum
- Comes with built-in socket, 15' pre-wired lamp cord, and hanging hooks
- The lamp is not included in the system
- New design: now available with wide side hinged opening with latch!

Available in 6" 8"



Comes with non-branded label
Customized label available



10-YEAR WARRANTY



Intertek



DESCRIPTION	ORDER CODE	REFLECTOR MATERIAL	REFLECTOR SIZE	PACKAGING DIMENSIONS	ACCEPTS	CASE QTY
LARGE 6" AIR-COOLED REFLECTOR	303212	HIGHLY REFLECTIVE ALUMINUM	27.2"(L)x24.6"(W)x9.7"(H)	29.3"(L)x25.9"(W)x11.3"(H)	HPS400W-1000W MH400W-1000W	1
3XL 8" AIR-COOLED REFLECTOR	303332	HIGHLY REFLECTIVE ALUMINUM	37"(L)x27.6"(W)x10.2"(H)	38.6"(L)x29.9"(W)x11.8"(H)	HPS400W-1000W MH400W-1000W	1

DOUBLE-ENDED WING REFLECTOR

- Heavy duty mounting bracket
- Rounded corners for safety
- Made from highly reflective textured aluminum for excellent light dispersal without "hot-spots"
- Comes with built-in UL listed socket and 15' pre-wired lamp cord
- The lamp is not included in the system



Comes with non-branded label
Customized label available



10-YEAR WARRANTY



Intertek

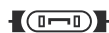

DOUBLE ENDED



DESCRIPTION	ORDER CODE	REFLECTOR MATERIAL	REFLECTOR SIZE	PACKAGING DIMENSIONS	ACCEPTS	CASE QTY
DOUBLE ENDED WING REFLECTOR	303215	HIGHLY REFLECTIVE ALUMINUM	17.3"(L) x 16.5"(W) x 4.3"(H)	18.9"(L) x 14"(W) x 5.9"(H)	DE HPS 1000W DE MH 1000W	1

GROW LIGHT REFLECTORS

DOUBLE-ENDED FLEXIBLE-WING REFLECTOR

- Highly reflective aluminum
- Comes with built-in Double Ended socket, 15' pre-wired lamp cord
- The lamp is not included in the system



10-YEAR WARRANTY



Intertek

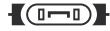

DOUBLE ENDED

Comes with non-branded label
Customized label available

DESCRIPTION	ORDER CODE	REFLECTOR MATERIAL	REFLECTOR SIZE	PACKAGING DIMENSIONS	ACCEPTS	CASE QTY
DOUBLE ENDED FLEXIBLE-WING REFLECTOR-MEDIUM	303105	HIGHLY REFLECTIVE ALUMINUM	21.7"(L) x 30.1"(W)	22.5"(L) x 16.5"(W) x 8.6"(H)	DE HPS 1000W DE MH 1000W	6
DOUBLE ENDED FLEXIBLE-WING REFLECTOR-LARGE	303115	HIGHLY REFLECTIVE ALUMINUM	27.6"(L) x 41.3"(W)	28.7"(L) x 22.6"(W) x 5"(H)	DE HPS 1000W DE MH 1000W	6

FLEXWING-DOUBLE ENDED ADJUST-WING REFLECTOR



- Reflector width is able to adjust in size using our innovative knob + wire tension system
- Comes with built-in Double Ended socket, 15' pre-wired lamp cord
- The lamp is not included in the system

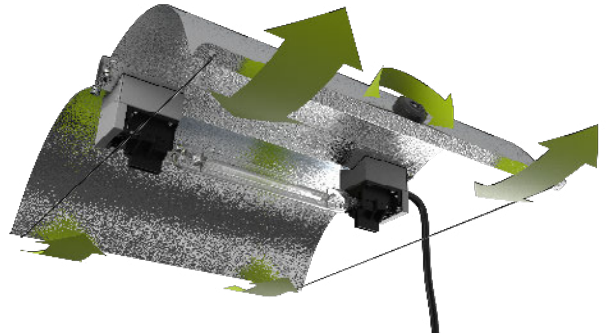

10-YEAR WARRANTY



Intertek

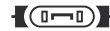

DOUBLE ENDED

Comes with non-branded label
Customized label available

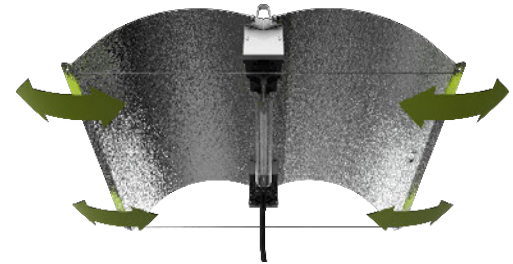

DESCRIPTION	ORDER CODE	REFLECTOR MATERIAL	REFLECTOR SIZE	PACKAGING DIMENSIONS	ACCEPTS	CASE QTY
FLEXWING-DOUBLE ENDED ADJUST-WING REFLECTOR-MEDIUM	303165	HIGHLY REFLECTIVE ALUMINUM	21.7"(L) x 30.1"(W)	22.5"(L) x 16.5"(W) x 8.6"(H)	DE HPS 1000W DE MH 1000W	6
FLEXWING-DOUBLE ENDED ADJUST-WING REFLECTOR-LARGE	303185	HIGHLY REFLECTIVE ALUMINUM	27.6"(L) x 41.3"(W)	28.7"(L) x 22.6"(W) x 5"(H)	DE HPS 1000W DE MH 1000W	6

GROW LIGHT REFLECTORS

DE SOCKET KIT WITH LAMP CORD FOR LARGE & MEDIUM FLEXIBLE-WING

- Turn your existing large or medium flexible-wing reflector into a double ended reflector
- Simply remove your existing socket and add this new double-ended socket kit with lamp cord
- Includes everything to make the switch
- Compatible with both medium and large flexible-wing reflector

Comes with non-branded label
Customized label available



DESCRIPTION	ORDER CODE	PACKAGING DIMENSIONS	CASE QTY
DE SOCKET KIT WITH LAMP CORD FOR LARGE & MEDIUM FLEXIBLE-WING	303124	22"(L) x 4.5"(W) x 2.9"(H)	10

DOUBLE ENDED STACKABLE 3XL REFLECTOR



- Easy set up - Only needs 2 minutes
- Uniquely designed plastic corners make the reflector much stronger than other similar products on the market
- 4 packed in a carton - Save 70% on shipping
- Made from premium highly reflective Aluminum
- Separately boxed pre-wired Double Ended socket, 15' lamp cord and hanging hooks

Comes with non-branded label
Customized label available



DESCRIPTION	ORDER CODE	REFLECTOR MATERIAL	REFLECTOR SIZE	PACKAGING DIMENSIONS	ACCEPTS	CASE QTY
DOUBLE-ENDED STACKABLE 3XL REFLECTOR	303602	HIGHLY REFLECTIVE ALUMINUM	36.5"(L) x 30.3"(W) x 8.5"(H)	38.6"(L) x 31.5"(W) x 15.4"(H)	DE HPS 1000W	4

COMPACT DOUBLE ENDED REFLECTOR

- Accommodates Double-ended 1000 watt HPS lamps
- Compact, rugged, stable and safe
- Uniformity >90% in every position, shielded terminals
- Made from premium highly reflective aluminum
- Comes with built-in socket, 15' pre-wired lamp cord

Comes with non-branded label
Customized label available



DESCRIPTION	ORDER CODE	REFLECTOR MATERIAL	REFLECTOR SIZE	PACKAGING DIMENSIONS	ACCEPTS	CASE QTY
COMPACT DOUBLE-ENDED REFLECTOR	303513	HIGHLY REFLECTIVE ALUMINUM	17.0"(L) x 9.2"(W) x 4.0"(H)	18.5"(L) x 10.5"(W) x 5.1"(H)	HPS600W-1000W MH600W-1000W	1

GROW LIGHT REFLECTORS

DOUBLE ENDED COOL-TUBE REFLECTOR

COOL, COMPACT & EFFICIENT !

- Accommodates most lamp types up to 1000W
- Internal and external reflectors included
- External reflector is removable
- Made from premium highly reflective aluminum
- Comes with built-in socket and 15' pre-wired lamp cord

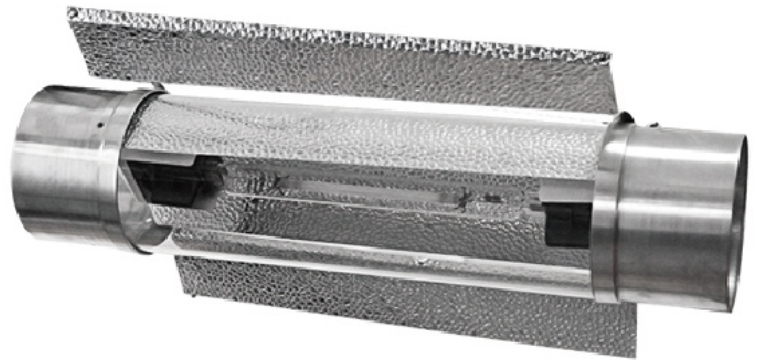

10-YEAR WARRANTY



Intertek

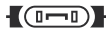

DOUBLE ENDED

DESCRIPTION	ORDER CODE	REFLECTOR MATERIAL	REFLECTOR SIZE	PACKAGING DIMENSIONS	ACCEPTS	CASE QTY
DOUBLE ENDED COOL-TUBE 6" AIR-COOLED REFLECTOR	303123	HIGHLY REFLECTIVE ALUMINUM	24.5"(L) x 6"(D)	27.2"(L) x 9.8"(W) x 8.4"(H)	DE HPS 1000W	1

SMART DOUBLE ENDED AIR-COOLED REFLECTOR

- Made specifically for double ended 1000 watt HPS horticulture lamps (not included)
- Unique double ended construction allows for maximum optical efficiency and uniformity
- This design allows removal of heat generated by the lamp without cooling the lamp below proper operating temperature
- Made from highly reflective aluminum
- Comes with built-in Double Ended socket, 15' pre-wired lamp cord and hanging hooks



Comes with non-branded label
Customized label available



10-YEAR WARRANTY



Intertek

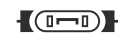

DOUBLE ENDED

DESCRIPTION	ORDER CODE	REFLECTOR MATERIAL	REFLECTOR SIZE	PACKAGING DIMENSIONS	CASE QTY
SMART DOUBLE ENDED AIR-COOLED REFLECTOR	303523	HIGHLY REFLECTIVE ALUMINUM	24.2"(L) x 19.2"(W) x 9.8"(H)	25.5"(L) x 22.0"(W) x 11.4"(H)	1

GROW LIGHT REFLECTORS

DOUBLE ENDED MEDIUM

- Completely sealed with neoprene gaskets and hinged glass
- Constructed with heavy duty pre-galvanized steel
- Multi-faceted computer-designed aluminum interior for maximum efficiency
- Made from premium highly reflective aluminum
- Comes with built-in Double Ended socket, 15' pre-wired lamp cord, and hanging hooks



10-YEAR WARRANTY



Intertek



DOUBLE ENDED

Comes with non-branded label
Customized label available

DESCRIPTION	ORDER CODE	REFLECTOR MATERIAL	REFLECTOR SIZE	PACKAGING DIMENSIONS	ACCEPTS	CASE QTY
DOUBLE ENDED MEDIUM 6" AIR-COOLED REFLECTOR	303112	HIGHLY REFLECTIVE ALUMINUM	27.3"(L) x 21"(W) x 9.3"(H)	29.7"(L) x 23"(W) x 10.5"(H)	DE HPS 1000W	1
DOUBLE ENDED MEDIUM 8" AIR-COOLED REFLECTOR	303202	HIGHLY REFLECTIVE ALUMINUM	26"(L) x 23.8"(W) x 10.2"(H)	29"(L) x 26"(W) x 11.2"(H)	DE HPS 1000W	1

DOUBLE ENDED AIR-COOLED REFLECTOR

- Completely sealed with gasketed glass for effective heat isolation and cooling
- Equipped with safety cable for safe and easy maintenance
- Made from premium highly reflective aluminum
- Comes with built-in Double Ended socket
- 15' pre-wired lamp cord and hanging hooks



10-YEAR WARRANTY



Intertek

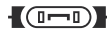

DOUBLE ENDED

Comes with non-branded label
Customized label available

DESCRIPTION	ORDER CODE	REFLECTOR MATERIAL	REFLECTOR SIZE	PACKAGING DIMENSIONS	ACCEPTS	CASE QTY
DOUBLE ENDED 3XL 8" AIR-COOLED REFLECTOR	303333	HIGHLY REFLECTIVE ALUMINUM	37"(L) x 27.6"(W) x 10.2"(H)	38.6"(L) x 29.9"(W) x 11.8"(H)	DE HPS 1000W DE MH 1000W	1

LAMP & REFLECTOR CLEANING CLOTH

- All lamps need to be wiped clean of finger prints after installation
 - Size: 12" x 15"
- Order code: 303100



REFLECTOR T LEVEL (TRIANGLE 2 WAY LEVEL W/ MAGNET)

- Use this triangle shape two-way level for easy, consistent, level hanging of your reflector
 - Material: ABS, Acrylic, solvent oil, strong magnet
 - Case QTY: 1000
- Order code: 303200



Product Weight: 12.80g

LIGHTING ACCESSORIES



**PUSH BUTTON
RELEASE SYSTEM**

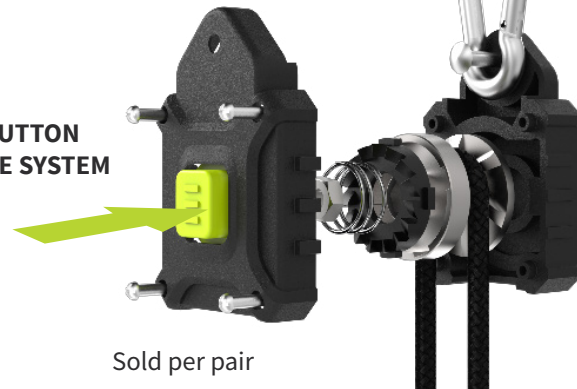

**NEW
PRODUCT**

EASY TO USE

PATENT PENDING

PYNCH 1/8" HEAVY DUTY ROPE RATCHET

Sold per pair

Order code: 303187

- 8' braided polypropylene rope
- Metal hardware and carabiner
- Composite ratchet mechanism
- Heat resistant composite housing
- Use to securely hoist your lighting fixtures, reflectors, carbon filters and HVAC equipment

**NEW
PRODUCT**

1/8" HEAVY DUTY HANGERS WITH METAL INTERNAL GEARS



- Metal carabiner & Metal Gear
 - 8' braided polypropylene rope
 - Secures items quickly and easily
 - Great for hoisting and securing
 - Metal Internal Gears
- Order code: 303127

1/4" ROPE RATCHET



- 8' braided polypropylene rope
 - Carabiner clips provide a secure hold
 - Secures items quickly and easily
 - Max weight capacity is 150 lbs each
- Order code: 303117

Sold per piece



Sold per pair

1/8" ROPE RATCHET

- 8' braided polypropylene rope
 - Secures items quickly and easily
 - Never breaks, slips, or rusts
 - Great for hoisting and securing
- Order code: 303107



EASY ROLLER (GROW YO-YO)

- Allows for easy height adjustment
 - Pair supports up to 24 lbs
- Order code: 303106



PLANT YOYO WITH STOPPER

- Easy to support your plants
 - Yo-yo string is 59.8" in length
- Order code: 303116

LIGHTING ACCESSORIES



PLUG ADAPTER BAASP

- The BAASP plug adapts ballast to hydrofarm reflector
- 3x14AWG STW
- Order code: 303108



PLUG ADAPTER BAASR

- The BAASR receptacle adapts a hydrofarm ballast to reflector
- 3x14AWG STW
- Order code: 303118



120V POWER CORD

- Compatible with all ballasts
- 8FT long, SJTW, 16 gauge
- Order code: 303128



240V POWER CORD

- Compatible with all ballasts
- 8FT long, SJTW, 16 gauge
- Order code: 303138

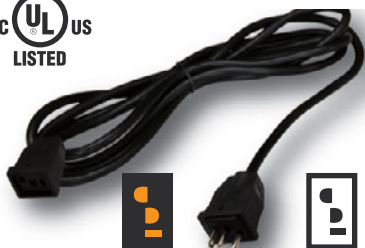

LAMP EXTENSION CORD

- Increase the distance between the ballast and reflector
- 10FT long, STW, 16 gauge
- Order code: 303148



POWER PLUG TO LAMP ADAPTOR

- For using CFL with a HID reflector
- Converts a reflector lamp cord plug to a standard US 120V plug
- 3x14AWG STW
- Order code: 303188

LIGHTING ACCESSORIES



POWER CORD WITH SOCKET

- 5kv mogul base socket
 - For use with mogul based self-ballasted compact fluorescent lamps
 - 8FT long, STW, 16 gauge
- Order code: 303158



LAMP CORD WITH SOCKET

- For use with all mogul based HPS & MH lamps (ballast required)
 - 5kv mogul base socket
 - 15FT long, STW, 16 gauge
- Order code: 303168



E39 TO PGZ18 SOCKET ADAPTOR

- 5KV mogul base socket
 - Voltage: 250V, socket current: 5A
 - 11.4" x 11.4" x 11.4"
 - N.W./G.W.: 16KG/17KG
- Order code: 303198
Case QTY: 100



120V GROUNDED 3 OUTLETS EXTENSION CORD

- Length: 15 ft, 14 Gauge
 - One year warranty, available in white color
- Order code: 303119



120V GROUNDED 3 OUTLETS EXTENSION CORD

- Length: 25 ft, 14 Gauge
 - One year warranty, available in white color
- Order code: 303121



DIY 15 FT REFLECTOR CORD -16 GAUGE

- Male plug on one end and open wiring on the other
 - Can be used to replace a reflector
- Order code: 303111

DUPLEX ELECTRICAL OUTLET

- Industrial grade duplex receptacle, 20 Amp current, 250V, white
 - 2 Pole, 3 wire, PC material
 - Back & side wire
 - Package: 13" x 9" x 7.9"
 - N.W./G.W.: 8.5KGS, product weight: 75g
 - Case Qty: 100
- Order code: 305111



120V INTO 240V / 240V INTO 120V ADAPTOR

- This adaptor should be used on electrical equipment which is rated for 120V into 240V or 240V into 120V
- Order code: 303218 (120V into 240V)
FOB Price(<500 pcs): US\$ 0.95
FOB Price(≥500 pcs): US\$ 0.85
Order code: 303228 (240V into 120V)



Order code: 303218
120V into 240V adaptor



Order code: 303228
240V into 120V adaptor

GROW GREENHOUSE WITH GROUND ANCHORING SYSTEM



Protect your plantings from many common animal pests! These Grow Greenhouses can offer a unique and affordable way to protect your plantings from deer, raccoons, rabbits, skunks, dogs, cats, and other nuisance animals. Grow Greenhouses come in different sizes to accommodate the weekend gardener to the serious horticulturist.

- One piece greenhouse cover
- Vent ready for adding odor-eliminating fan and filtration system
- Roll-up bottom vents
- Roll-up zippered front door and roll-up windows with bug screen
- Requires only pliers or crescent wrench to assemble
- Lockable latch included

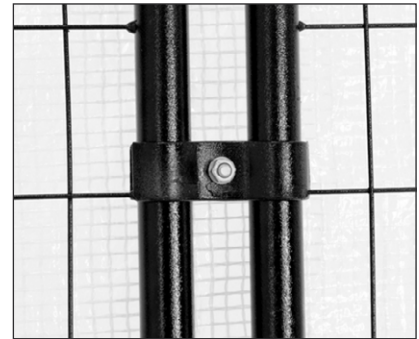
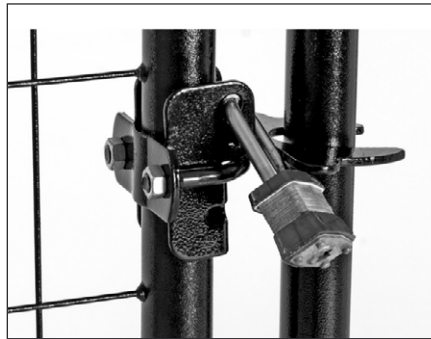
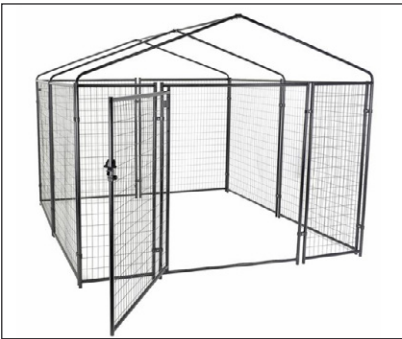

DESCRIPTION	ORDER CODE	PRODUCT SIZE	WIRE MESH	STEEL FRAME	FINISH	PACKING	N.W./G.W.	VOLUME SET	MOQ
GROW GREENHOUSE WITH GROUND ANCHORING SYSTEM 10' X 10'	303611	10' X 10'	1.96"x0.98"(Q195) 20GA FORMED	ROUND TUBE 1.25" x 0.04" MMT (Q235)	POWDER COATING	STEEL PALLET+ CARTON BOX	64.50/65.00	0.54	10
GROW GREENHOUSE WITH GROUND ANCHORING SYSTEM 10' X 15'	303612	10' X 15'	1.96"x0.98"(Q195) 20GA FORMED	ROUND TUBE 1.25" x 0.04" MMT (Q235)	POWDER COATING	STEEL PALLET+ CARTON BOX	75.00/75.50	0.68	10
GROW GREENHOUSE WITH GROUND ANCHORING SYSTEM 10' X 20'	303613	10' X 20'	1.96"x0.98"(Q195) 20GA FORMED	ROUND TUBE 1.25" x 0.04" MMT (Q235)	POWDER COATING	STEEL PALLET+ CARTON BOX	85.00/85.50	0.77	10
GROW CHAIN LINK GREENHOUSE WITH GROUND ANCHORING SYSTEM 8' X 6'	303614	8' X 6'	1.96"x0.98"(Q195) 20GA FORMED	ROUND TUBE 1.25" x 0.04" MMT (Q235)	POWDER COATING	STEEL PALLET+ CARTON BOX	36.50/37.00	0.30	10
GROW CHAIN LINK GREENHOUSE WITH GROUND ANCHORING SYSTEM 10' X 8'	303615	10' X 8'	1.96"x0.98"(Q195) 16GA FORMED	ROUND TUBE 1.25" x 0.04" MMT (Q235)	POWDER COATING	STEEL PALLET+ CARTON BOX	40.60/41.10	0.35	10

GROW TENTS

US STANDARD GROW TENT



- DETACHABLE HEAVY DUTY STEEL POLES TO SAVE SHIPPING COSTS

- OPTIONAL TWO TYPES OF INNER FINISHING: STUCCO DIAMOND



- HEAVY DUTY 600D FABRIC WITH DOUBLE STITCH
- MOQ: 20 PCS

- SILK SCREENED
- DETAILED INSTRUCTION
- HEAVY DUTY 7 LAYER CARTON

- HEAVY DUTY SBS ZIPPERS

DESCRIPTION	ORDER CODE	LIGHTING ADVISED TYPE	EXTERNAL ASSEMBLED DIMENSIONS	DOORS			WINDOWS		SOCKETS				PACKAGING DIMENSIONS	TUBE DIA
				FRONT	REAR	SIDE	VENTILATION	CLEAR	EXTRACTION	INTRACTION	CABLES	AIR-COOLED HOODS		
2'X2'	304801	1x250W COOLED	24"(W)x24"(D)x56"(H)	1	—	—	3	1	1x6"	—	2x4"	2x6"	32.3"(W)x9"(D)x4.3"(H)	16x0.8
2'X4'	304802	1x400W COOLED	24"(W)x48"(D)x60"(H)	1	—	—	3	1	1x6"	—	2x6"	2x6"	55.1"(W)x11.4"(D)x5.5"(H)	16x0.8
3'X3'	304803	1x400W COOLED	36"(W)x36"(D)x72"(H)	1	—	2	3	1	1x6"	2x6"	2x4"	2x6"	45.3"(W)x9.8"(D)x4.7"(H)	16x0.8
4'X4'	304804	1x600W COOLED	48"(W)x48"(D)x80"(H)	1	—	2	3	1	1x8"	2x6"	2x4"	2x6"+2x8"	55.1"(W)x9.8"(D)x4.7"(H)	16x0.8
4'X6'	304805	1x1000W COOLED	48"(W)x72"(D)x80"(H)	2	2	—	4	2	2x8"	2x6"	4x4"	2x6"+2x8"	55.1"(W)x9.8"(D)x5.1"(H)	16x0.8
4'X8'	304806	2x600W COOLED	48"(W)x96"(D)x80"(H)	2	2	—	4	2	2x8"	2x6"	4x4"	2x6"+2x8"	55.1"(W)x11"(D)x6.7"(H)	16x0.8
5'X5'	304807	1x1000W COOLED	60"(W)x60"(D)x80"(H)	1	—	2	3	1	1x8"	2x6"	2x4"	2x6"+2x8"	55.9"(W)x12.2"(D)x5.9"(H)	16x0.8
8'X8'	304808	2x1000W COOLED	96"(W)x96"(D)x80"(H)	2	2	—	6	2	2x8"	2x6"	4x4"	2x6"+2x8"	55.9"(W)x12.2"(D)x5.9"(H)	16x0.8
10'X10'	304809	4x600W COOLED	120"(W)x120"(D)x80"(H)	2	2	—	6	2	2x8"	2x6"	4x4"	2x6"+2x8"	47.2"(W)x11"(D)x6.7"(H)	19x0.8
6'X6'	304810	4x1000W COOLED	72"(W)x72"(D)x80"(H)	2	2	—	6	2	2x8"	2x6"	4x4"	2x6"+2x8"	59.1"(W)x11"(D)x12.6"(H)	19x0.8
12'X12'	304811	4x1000W COOLED	144"(W)x144"(D)x80"(H)	2	2	—	6	2	2x8"	2x6"	4x4"	2x6"+2x8"	32.3"(W)x9"(D)x4.3"(H)	22x1.0

GROW TENTS

GROWHUB SERIES

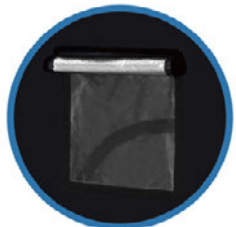

Windows



Convenient tool pouch

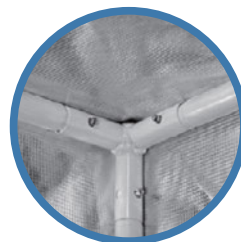
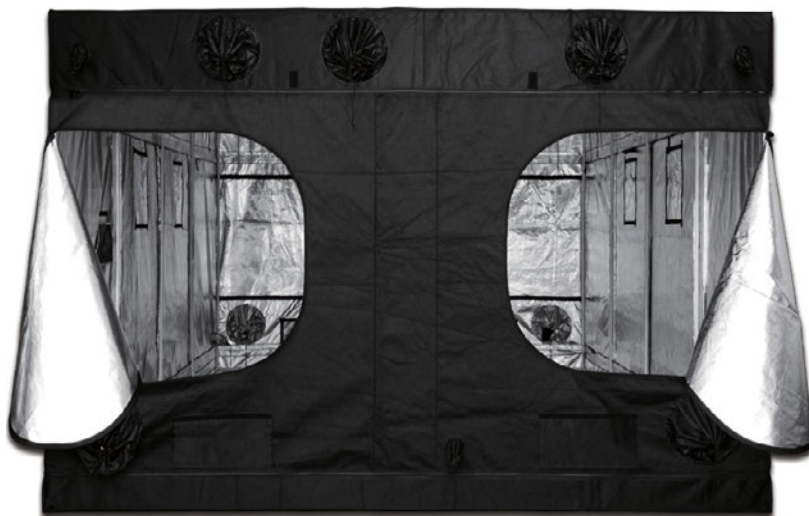

All metal, interlocking, support frame, making them the strongest tents

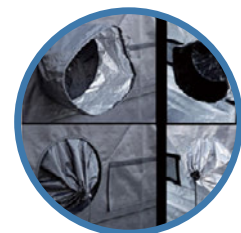

Dual clinching ducts

THE IDEAL GROW TENTS FOR BOTH PROFESSIONAL AND BEGINNER GROWERS

- 12" height extension kits
- 100% metal, no plastic anywhere-the poles are 100% metal and each has fasteners that securely lock your structure in place
- The thickest material-1680D diamond reflective walls that are 9x (compared to 190D/600D) stronger than any other grow tent. The added thickness makes the walls light impermeable, resistant to orders, sound resistant, and properly insulated for optimal temperature
- Easy view windows- our observation window makes it easy and comfortable to take a peek inside



DESCRIPTION	ORDER CODE	EXTERIOR DIMENSIONS	HEIGHT WITH EXTENSION	TUBE DIA.
2 FT X 4 FT X 6'11"(W/ EXT.7'11") 1FT HEIGHT EXTENSION KIT	304901	24" x 48" x 81"	93"	19MM
3 FT X 3 FT X 6'11"(W/ EXT.7'11") 1FT HEIGHT EXTENSION KIT	304902	36" x 36" x 81"	93"	19MM
4 FT X 4 FT X 6'11"(W/ EXT.7'11") 1FT HEIGHT EXTENSION KIT	304903	48" x 48" x 81"	93"	19MM
5 FT X 5 FT X 6'11"(W/ EXT.7'11") 1FT HEIGHT EXTENSION KIT	304904	60" x 60" x 81"	93"	22MM
4 FT X 8 FT X 6'11"(W/ EXT.7'11") 1FT HEIGHT EXTENSION KIT	304905	48" x 96" x 81"	93"	22MM
8 FT X 8 FT X 6'11"(W/ EXT.7'11") 1FT HEIGHT EXTENSION KIT	304906	96" x 96" x 81"	93"	22MM
10 FT X 10 FT X 6'11"(W/ EXT.7'11") 1FT HEIGHT EXTENSION KIT	304907	120" x 120" x 81"	93"	22MM
10 FT X 20 FT X 6'11"(W/ EXT.7'11") 1FT HEIGHT EXTENSION KIT	304908	120" x 240" x 81"	93"	22MM
12 FT X 12 FT X 6'11"(W/ EXT.7'11") 1FT HEIGHT EXTENSION KIT	304909	144" x 144" x 81"	93"	22MM

ORDER CODE	DESCRIPTION
304901EX	2' HEIHTT EXTENSION KIT FOR 2FT X 4FT
304902EX	2' HEIHTT EXTENSION KIT FOR 3FT X 3FT
304903EX	2' HEIHTT EXTENSION KIT FOR 4FT X 4FT
304904EX	2' HEIHTT EXTENSION KIT FOR 5FT X 5FT
304905EX	2' HEIHTT EXTENSION KIT FOR 4FT X 8FT
304906EX	2' HEIHTT EXTENSION KIT FOR 8FT X 8FT
304907EX	2' HEIHTT EXTENSION KIT FOR 10FT X 10FT
304908EX	2' HEIHTT EXTENSION KIT FOR 10FT X 20FT
304909EX	2' HEIHTT EXTENSION KIT FOR 12FT X 12FT

7-DAY DUAL OUTLET DIGITAL TIMER

- 1 Minute On/Off
- 15 Amps
- Up to 8 On/Offs per day
- Different Days & Cycles
- Controls 2 outlets simultaneously
- Order code: 305103
- Case Qty: 40
- Packaging Dimensions: 21.7"x19"x12.2"



DUAL OUTLET GROUNDED TIMER

- 15 Minute On/Off
- 24 Hour Cycle
- Controls 2 outlets simultaneously
- 15 Amps
- Dual outlet grounded timer
- Order code: 305102
- Case Qty: 40
- Packaging Dimensions: 21.7"x19"x12.2"



24 HOUR GROUNDED TIMER

- 15 Minute On/Off
- 15 Amps
- Great for lighting, pumps, etc...
- Easy to use
- Order code: 305101
- Case Qty: 50
- Packaging Dimensions: 24.6"x16.3"x12.6"



7-DAY GROUNDED DIGITAL TIMER

- 1 Minute On/Off
- 15 Amps
- Up to 8 On/Offs per day
- Excellent for hydro systems
- Order code: 305104
- Case Qty: 50
- Packaging Dimensions: 24.6"x16.3"x12.6"



METERS



PH METER SWPH-902A

- Measuring range: 0.00-14.00PH
- Accuracy: ± 0.1 PH;
- Resolution: 0.01PH
- Large and easy-to-read LCD
- Order code: 305124



EC, CF, PPM NUTRIENT METER SWRS-100A

- Range: 4-44CF; 0.4-4.4EC; 280-3080ppm
- Resolution: 0.1 EC(I CF)
- Accuracy: $\pm 4\%$ of reading
- Order code: 305122



LUX TESTER METER

- High accuracy in measuring
- LSI-circuit use provides high reliability and durability
- Low battery indicator
- Adjusting zero automatically
- Order code: 331301



LASER THERMOMETER

- Noncontact measuring
- Inside laser aimer
- Auto-data hold and auto-turn off
- Order code: 331401



3-WAY MOISTURE LIGHT & PH METER

- Gardeners can conveniently test their moisture, light, pH
- Packaging Dimensions: 20.4"x11.8"x19.6"
- Order code: 305131



LARGE DISPLAY THERM. HYGROMETER 03

- 12/24 hour mode switch
- Water proof temperature probe
- Uses 1 AAA battery (included)
- Order code: 305132

INDOOR THERMOMETER AND HYGROMETER

- Indoor temperature range: $-10^{\circ}\text{C} \sim 50^{\circ}\text{C}$
- Humidity range: 20% ~ 95%



DESCRIPTION	ORDER CODE	POWER CONSUMPTION	PRODUCT DIMENSIONS	PACKAGING DIMENSIONS	N.W.	G.W.	Case QTY	ETD
INDOOR THERMOMETER AND HYGROMETER	305133	POWER:2*AAA (NOT INCLUDED)	4.5"(L) x 2.8"(W) x 0.9"(H)	18.3"(L) x 15.7"(W) x 12.2"(H)	8.80KG	9.80KG	100	60



PLANT LIGHT ANALYZER

PLANT LIGHT ANALYZER

Specifically designed for plant lighting analyzation and leading a new era for field spectral measurements. Adopts the international patents with no spectral mismatch error offering super high accuracy and a complete array of parameters

- Photosynthetic Photon Flux Density PPF EQ
- Phytometric Irradiance EP
- Chlorophyll-A Weighted Irradiance Ech-A
- Chlorophyll-B Weighted Irradiance Ech-B



ACCURACY	WAVELENGTH ACCURACY: ±0.5NM ILLUMINANCE ACCURACY: ±(4% READING +1 DIGIT) ACCURACY OF CHROMATICITY COORDINATE: ±0.001(RELATIVE TO THE STANDARD LIGHT SOURCE WHOSE STABILITY BETTER THAN ± 0.0001 AND NIM TRACEABLE CALIBRATED VALUE)
LIGHTING AREA	Φ 8MM
STRAY LIGHT	≤ 0.5%
INTEGRATING TIME	5MS-60000MS
RANGE	CCT RANGE: 1000K-100000K ILLUMINANCE RANGE: 10IX-200KIX WORKING T/H RANGE: (5-30)°C RH < 80% (NO CONDENSE) STORE T/H RANGE: (0-35)°C RH < 80% (NO CONDENSE)
COMMUNICATION	MAIN BOARD--DETECTOR: MINI USB/ BLUETOOTH MAIN BOARD--PC: USB/WIFI
ACCESSORIES INCLUDES	LITHIUM BATTERY(1PC), ADAPTER(1PC) USB CABLE(1PC) MAIN BOARD-DETECTOR CONNECT ABLE(1PC)
WARRANTY	1 YEAR



DESCRIPTION	ORDER CODE	SCREEN	DATA STORE	POWER SUPPLY	DIMENSION	WEIGHT WITH BATTERY	CASE QTY
PLANT LIGHT ANALYZER	301666	4.2" LCD TOUCHABLE SCREEN	4G SD CARD (BUILT IN)	LITHIUM BATTERY	7"(L) x 2.8"(W) x 1.1"(H)	200G	1

CLIMATE CONTROL PRODUCTS

HIGHLY REFLECTIVE FILM

- Light proof
- Durable, puncture and tear resistant
- 9 rolls per carton

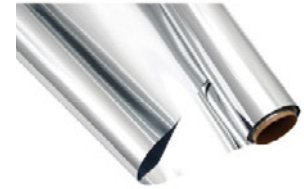

DESCRIPTION	ORDER CODE	THICKNESS	WIDTH	LENGTH	CASE QTY	PACKAGING DIMENSIONS
HIGHLY REFLECTIVE FILM 1MIL 48" x 25'	308101	1 MIL	48"	25'	9	49.6"L x 8.1"W x 8.1"H
HIGHLY REFLECTIVE FILM 1MIL 48" x 50'	308111	1 MIL	48"	50'	9	49.6"L x 8.1"W x 8.1"H
HIGHLY REFLECTIVE FILM 1MIL 48" x 100'	308121	1 MIL	48"	100'	9	49.6"L x 8.1"W x 8.1"H
HIGHLY REFLECTIVE FILM 2MIL 48" x 25'	308131	2 MIL	48"	25'	9	49.6"L x 8.1"W x 8.1"H
HIGHLY REFLECTIVE FILM 2MIL 48" x 50'	308141	2 MIL	48"	50'	9	49.6"L x 8.1"W x 8.1"H
HIGHLY REFLECTIVE FILM 2MIL 48" x 100'	308151	2 MIL	48"	100'	9	49.6"L x 8.1"W x 8.1"H

BLACK & WHITE FILM (PANDA FILM)

- 100% light proof
- Made from 100% virgin material
- 100' per carton



DESCRIPTION	ORDER CODE	THICKNESS	WIDTH	LENGTH	CASE QTY	PACKAGING DIMENSIONS
BLACK & WHITE FILM 6MIL, 10FT x 25FT	308102	6 MIL	10'	25'	4	37.6"L x 7.9"W x 7.9"H
BLACK & WHITE FILM 6MIL, 10FT x 50FT	308112	6 MIL	10'	50'	2	37.6"L x 7.9"W x 7.9"H
BLACK & WHITE FILM 6MIL, 10FT x 100FT	308122	6 MIL	10'	100'	1	37.6"L x 7.9"W x 7.9"H

DIAMOND SILVER WHITE FILM

- Spreads light more evenly and eliminates grow room hot spots
- 100% light tight
- PET coated to protect against corrosion and wear

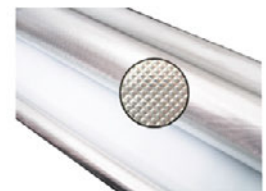

DESCRIPTION	ORDER CODE	THICKNESS	WIDTH	LENGTH	CASE QTY	PACKAGING DIMENSIONS
DIAMOND SILVER WHITE FILM 48" x 10'	308104-4	6 MIL	48'	10'	9	49.6"L x 4.7"W x 4.7"H
DIAMOND SILVER WHITE FILM 48" x 25'	308104-1	6 MIL	48'	25'	6	49.6"L x 4.7"W x 4.7"H
DIAMOND SILVER WHITE FILM 48" x 50'	308104-2	6 MIL	48'	50'	4	49.6"L x 4.7"W x 4.7"H
DIAMOND SILVER WHITE FILM 48" x 100'	308104-3	6 MIL	48'	100'	2	49.6"L x 4.7"W x 4.7"H

FOIL BUBBLE FILM

- Foil Bubble is a barrier bubble film laminated between 2 layers of foil
- Helps to manage heating problems associated with indoor gardening, conserves energy, reflects up to 97% of all radiant heat and inhibits the growth of fungi or bacteria



DESCRIPTION	ORDER CODE	THICKNESS	WIDTH	LENGTH	CASE QTY
FOIL BUBBLE FILM 4FT x 25FT ROLL	308105-1	0.15"/320GSM	4'	25'	1
FOIL BUBBLE FILM 4FT x 50FT ROLL	308105-2	0.15"/320GSM	4'	50'	1
FOIL BUBBLE FILM 4FT x 100FT ROLL	308105-3	0.15"/320GSM	4'	100'	1

DUCT BOOSTER FAN

- High pressures, strong airflow
 - Low noise levels
 - Reasonable price high quality
 - With pre-wired 1.6m 120V/240V power cord
- MOQ: 30PCS



DESCRIPTION	ORDER CODE	TUBE CONNECTION	POWER	AIR FLOW	SPEED	NOISE LEVEL	PACKAGING DIMENSION
			W	CFM	[R/MIN]	[DB(A)]	
DUCT BOOSTER FAN 4"	331101-4	4"	14	100	2900	45	13.5"L x 11.2"W x 8.2"H
DUCT BOOSTER FAN 6"	331101-6	6"	40	240	2900	51	15.1"L x 13"W x 8.2"H
DUCT BOOSTER FAN 8"	331101-8	8"	40	400	2900	55	18.9"L x 17.3"W x 8.6"H
DUCT BOOSTER FAN 10"	331101-10	10"	95/98	1125	2850	73.5	15.9"L x 14.3"W x 11.6"H

PLASTIC FAN

Greenhouse 4" 5" 6"
Small Plastic Centrifugal Duct Fan

- Specially designed for indoor cultivation
- Included cable and plug, ready to use
- Quiet, and easy use of low energy
- No grid, fit into metal or flex ducts
- 100% new ABS plastic; 100% copper oil-bearing motor
- Customize logo, package available
- Rated Voltage: 110V/220V, Rated Voltage: 50Hz



DESCRIPTION	ORDER CODE	POWER	NOISE	AIR VOLUME	HOLE SIZE	PCS/CTN	DIMENSION	SPEED
		W	[DB(A)]	M ³ /H	MM			
PLASTIC FAN 4"/100MM	331102-4	12	34	130	100MM	40	18.1" x 12.7" x 19.6"	2000R/MIN
PLASTIC FAN 5"/125MM	331102-5	16	34	240	125MM	40	22" x 11.2" x 19.6"	2200R/MIN
PLASTIC FAN 6"/150MM	331102-6	18	35	320	150MM	40	25.9" x 13.1" x 23.6"	2400R/MIN

IN-LINE FAN

- Quiet operation
- Durable ceramic-coated metal housing
- ETL recognized components
- High quality molded impeller
- Thermally protected AC motor
- Includes mounting brackets
- Includes 8 ft. pre-wired 120V cord
- Precision crafted bearings imported from Japan NSK



Pic 1



Pic 2



203CFM



412CFM



677CFM



706CFM



1060CFM

DESCRIPTION	ORDER CODE	VOLTAGE FREQUENCY	AIRFLOW		SPEED RPM	POWER W	CURRENT A	PACKAGING DIMENSION
			CMH	CFM				
INLINE FAN 4"	306101-4	120V/60HZ	345	203	2500	87	0.78	12"L x 10"W x 9"H
INLINE FAN 6"	306101-6	120V/60HZ	700	412	2500	135	1.20	13"L x 12"W x 10"H
INLINE FAN 8"	306101-8	120V/60HZ	1150	677	2550	205	1.75	16"L x 14"W x 11"H
INLINE FAN 10"	306101-10	120V/60HZ	1200	706	2550	205	1.75	16"L x 14"W x 11"H
INLINE FAN 12"	306101-12	120V/60HZ	1800	1060	2500	205	1.75	18"L x 17"W x 11"H

VARIABLE FAN SPEED CONTROL

- 3 Setting: Off, Full, and Variable
- Easy to adjust fan speed
- 1-Year Warranty
- 24/case



1-YEAR WARRANTY



DESCRIPTION	ORDER CODE	VOLTAGE FREQUENCY	MAX.AMPERAGE	WEIGHT	PACKAGING DIMENSION
			A	LBS	
VARIABLE FAN SPEED CONTROL	306119	120V/60HZ	15.0	1.0	2.4"L x 2.0"W x 3.3"H

PLASTIC INLINE TUBE FAN

- Fan diameter : 3.9inch to 7.8 inch
- The voltage : 110-120V/60Hz
- Color: Black and Red
- Operating temperature rage: -20°C~60°C
- Long life with low energy consumption



DESCRIPTION	ORDER CODE	VOLTAGE FREQUENCY	POWER	AIR FLOW		SPEED	CURRENT	PACKAGING DIMENSION
			W	CMH	CFM	RPM	A	
PLASTIC INLINE TUBE FAN 4"	306201-100	110-120V/60HZ	60	220	188	2400	0.85	12.6"L x 8.6"W x 9.6"H
PLASTIC INLINE TUBE FAN 5"	306201-125	110-120V/60HZ	40	310	183	2500	0.30	10.8"L x 8.6"W x 9.6"H
PLASTIC INLINE TUBE FAN 6"	306201-150	110-120V/60HZ	70	580	395	2400	0.58	13.4"L x 9.6"W x 10.2"H
PLASTIC INLINE TUBE FAN 8"	306201-200	110-120V/60HZ	190	1000	735	2450	1.59	12.2"L x 9.8"W x 9.8"H

MIXED FLOW FAN

- Superior performance and outstanding efficiency at an affordable price
- Powerful motor and injection molded plastic blade create forceful CFM's
- Less noise than traditional inline fans
- 6"-14" come pre-wired with an 8 ft 120 volt power cord
- Comes pre-wired with a 7 foot 120 volt power cord



6"

8"

10"

12"



400CFM

850CFM

1200CFM

1700CFM



DESCRIPTION	ORDER CODE	VOLTAGE FREQUENCY	AIRFLOW		SPEED	POWER	CURRENT	NOISE	PACKAGING DIMENSION
			CMH	CFM	RPM	W	A	DB(A)	
MIXED FLOW FAN 6"	306201-6	120V/60HZ	550	400	3350	71	0.66	≤58	10"L x 8.7"W x 8.7"H
MIXED FLOW FAN 8"	306201-8	120V/60HZ	1050	850	3300	160	1.50	≤60	10"L x 8.7"W x 8.7"H
MIXED FLOW FAN 10"	306201-10	120V/60HZ	1550	1200	3050	200	1.70	≤62	12"L x 9.4"W x 11"H
MIXED FLOW FAN 12"	306201-12	120V/60HZ	2850	1700	3350	440	3.30	≤63	14"L x 12.8"W x 13"H
MIXED FLOW FAN 14"	306201-14	120V/60HZ	2709	1700	1700	237	2.10	≤60	14.8"L x 14.5"W x 16.5"H

16" WALL MOUNT FAN

- Watt: 50-55W
- Motor Size: 2.6 x 0.5 inch
- Power cord: 2 x 0.75 x 5ft (white, UL plug)
- Voltage/Frequency: 110V/60Hz
- Speed setting: 3 speeds
- Oscillating degree: 80°



1-YEAR WARRANTY



DESCRIPTION	ORDER CODE	WATT	ORDER CODE	VOLTAGE FREQUENCY	SPEED SETTING	OSCILLATING DEGREE	MOQ
16" WALL MOUNT FAN	306102	50-55W	2.6" x 0.5"	110V/60HZ	3 SPEEDS	80°	50 PCS

20" HIGH VELOCITY METAL OSCILLATING STAND FAN



- 110V/60Hz
- Height velocity, 3 speed with oscillation, aluminium blade
- Black powder coated blade, grill & stand
- Runs at 4500 CFM and 1400 RPM
- Has an adjustable height from 39" to 54" tall with a round sturdy weighted base
- 5' 120 volt power cord



1-YEAR WARRANTY



DESCRIPTION	ORDER CODE	SIZE	POWER	PACKAGE	N.W.	G.W.	PRODUCT SIZE	CASE QTY
20" HIGH VELOCITY METAL OSCILLATING STAND FAN	306132	20"	110W	COLOR BOX	9.2 KG	8.1 KG	21.7" (L) X 17.7" (W) X 50" (H)	1

20" FLOOR FAN



- 110V/60Hz, 3 aluminum blades
- Speed Control (0-1-2-3) + with-slip feet
- Copper clad aluminum motor
- 5' 120 volt power cord



1-YEAR WARRANTY



DESCRIPTION	ORDER CODE	SIZE	POWER	PACKAGE	OSCILLATING	N.W.	G.W.	PRODUCT SIZE	CASE QTY
20" FLOOR FAN	306142	20"	165W	COLOR BOX	120°C	5.5 KG	6.5 KG	23.2" (L) X 6.7" (W) X 23.4" (H)	1

6" DESK & CLIP FAN



- Two speeds, non-oscillating
- Strong spring-loaded clip for multiple uses
- Typically used in grow tent by clip on poles
- Function of 3 in 1: table fan, wall fan, clip fan
- Power Cord: 2 x 0.75 x 5ft, UL plug

MOQ: 500 PCS



DESCRIPTION	ORDER CODE	POWER CORD	DIAMETER	CASE QTY	PACKAGING DIMENSIONS
6" DESK & CLIP FAN	331201	20W	6.3"	12	17.1"L x 16.3"W x 23.8"H

CARBON FILTERS CARBON BED 2 INCH

- Cone shaped base funnels air flow into filter
- Highly effective, low density virgin carbon
- Machine packed carbon enables 100% filtered air flow
- Inner and outer mesh provides 53% open area allowing increased air flow
- Includes changeable Velcro pre-filter
- Switchable filter flange and base for longer lifetime
- Aluminum tops and bases for reduced weight

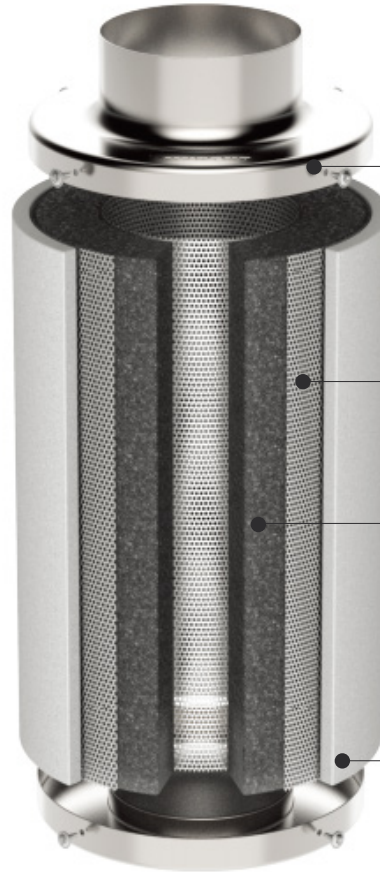

SWITCHABLE FILTER FLANGE AND BASE FOR LONGER LIFETIME

INNER AND OUTER MESH PROVIDES 53% OPEN AREA ALLOWING INCREASED AIR FLOW

1050+ AUSTRALIAN VIRGIN CHARCOAL BED

PRE-FILTER

DESCRIPTION	ORDER CODE	SIZE IN INCH	SIZE IN MM	CARBON BED DEPTH	AIRFLOW		WEIGHT LBS	PACKAGING DIMENSION
					CMH	CFM		
CARBON FILTER 4" x 12"	306103-0412	4" x 12"	Φ100×300 MM	8"	340	200	5.7	9.5"L x 9.5"W x 13.2"H
CARBON FILTER 4" x 16"	306103-0416	4" x 16"	Φ100×400 MM	8"	475	278	6.4	9.5"L x 9.5"W x 17.2"H
CARBON FILTER 4" x 20"	306103-0420	4" x 20"	Φ100×500 MM	8"	595	350	10.3	7.9"L x 7.9"W x 21.1"H
CARBON FILTER 6" x 12"	306103-0612	6" x 12"	Φ150×300 MM	10"	468	275	11.2	11.4"L x 11.4"W x 13.2"H
CARBON FILTER 6" x 16"	306103-0616	6" x 16"	Φ150×400 MM	10"	680	400	14.1	11.4"L x 11.4"W x 17.1"H
CARBON FILTER 6" x 20"	306103-0620	6" x 20"	Φ150×500 MM	10"	765	450	17.4	11.4"L x 11.4"W x 21.1"H
CARBON FILTER 6" x 24"	306103-0624	6" x 24"	Φ150×600 MM	10"	935	550	24.0	11.4"L x 11.4"W x 25"H
CARBON FILTER 6" x 39"	306103-0639	6" x 39"	Φ150×1000 MM	10"	1360	800	43.0	11.4"L x 11.4"W x 40.8"H
CARBON FILTER 8" x 24"	306103-0824	8" x 24"	Φ200×600 MM	12"	1275	750	25.1	13.5"L x 13.5"W x 25"H
CARBON FILTER 8" x 39"	306103-0839	8" x 39"	Φ200×1000 MM	12"	1615	950	42.5	13.4"L x 13.4"W x 40.8"H
CARBON FILTER 10" x 24"	306103-1024	10" x 24"	Φ250×600 MM	14"	1445	850	32.6	15.4"L x 15.4"W x 25.0"H
CARBON FILTER 10" x 39"	306103-1039	10" x 39"	Φ250×1000 MM	14"	2380	1400	53.0	15.4"L x 15.4"W x 40.8"H
CARBON FILTER 12" x 39"	306103-1239	12" x 39"	Φ300×1000 MM	16"	2890	1700	54.0	17.4"L x 17.4"W x 40.8"H
CARBON FILTER 12" x 48"	306103-1248	12" x 48"	Φ300×1200 MM	16"	3740	2200	71.2	17.4"L x 17.4"W x 48.7"H

CARBON FILTERS CARBON BED 1.5 INCH

- Highly effective, low density virgin carbon
- Machine packed carbon enables 100% filtered air flow
- Inner and outer mesh provides 53% open area allowing increased air flow
- Includes changeable Velcro pre-filter
- Switchable filter flange and base for longer lifetime
- Large selection of sizes available to fit any application

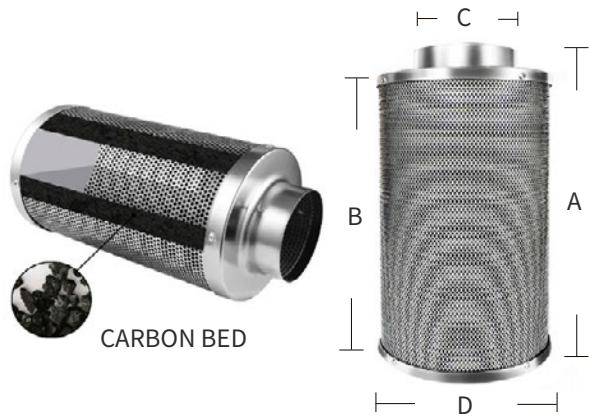

DESCRIPTION	ORDER CODE	CONFIGURATION SIZE C X B X A X D	CARBON BED DEPTH	CARBON WEIGHT	PACKING DIMENSIONS	N.W./G.W.	AIRFLOW
CARBON FILTER 4" x 8"	306123-0408	4" x 8" x 10" x 7"	7"	1.2 kg	7.7"L x 7.7"W x 10.6"H	1.9/2.3kg	140
CARBON FILTER 4" x 10"	306123-0410	4" x 10" x 12" x 7"	7"	1.6 kg	7.7"L x 7.7"W x 12.6"H	2.1/3.2kg	175
CARBON FILTER 4" x 12"	306123-0412	4" x 12" x 14" x 7"	7"	1.9 kg	7.7"L x 7.7"W x 14.6"H	2.9/3.4kg	210
CARBON FILTER 4" x 20"	306123-0420	4" x 20" x 22" x 7"	7"	3.2 kg	7.7"L x 7.7"W x 22.4"H	4.2/5.0kg	350
CARBON FILTER 5" x 10"	306123-0510	5" x 10" x 12" x 8"	8"	1.9 kg	8.9"L x 8.9"W x 12.6"H	2.9/3.3kg	200
CARBON FILTER 5" x 16"	306123-0516	5" x 16" x 18" x 8"	8"	3.3 kg	8.9"L x 8.9"W x 18.5"H	4.6/5.1kg	310
CARBON FILTER 5" x 20"	306123-0520	5" x 20" x 22" x 8"	8"	4.1 kg	8.9"L x 8.9"W x 22.4"H	5.5/6.3kg	375
CARBON FILTER 5" x 24"	306123-0524	5" x 24" x 26" x 8"	8"	4.9 kg	8.9"L x 8.9"W x 26.4"H	6.4/7.1kg	450
CARBON FILTER 6" x 12"	306123-0612	6" x 12" x 14" x 9"	9"	2.8 kg	9.5"L x 9.5"W x 14.6"H	4.4/5.0kg	290
CARBON FILTER 6" x 16"	306123-0616	6" x 16" x 18" x 9"	9"	3.7 kg	9.5"L x 9.5"W x 18.5"H	5.4/6.0kg	384
CARBON FILTER 6" x 20"	306123-0620	6" x 20" x 22" x 9"	9"	4.7 kg	9.5"L x 9.5"W x 22.4"H	6.6/7.4kg	480
CARBON FILTER 6" x 24"	306123-0624	6" x 24" x 26" x 9"	9"	5.6 kg	9.5"L x 9.5"W x 26.4"H	7.7/8.6kg	576
CARBON FILTER 6" x 39"	306123-0639	6" x 39" x 41" x 9"	9"	9.5 kg	9.5"L x 9.5"W x 42.1"H	11.8/13.0kg	950
CARBON FILTER 8" x 16"	306123-0816	8" x 16" x 18" x 11"	11"	4.6 kg	11.6"L x 11.6"W x 19.6"H	6.1/7.0kg	610
CARBON FILTER 8" x 20"	306123-0820	8" X 20" X 22" x 11"	11"	6.5 kg	11.6"L x 11.6"W x 24"H	8.1/9.0kg	912
CARBON FILTER 8" x 24"	306123-0824	8" x 24" x 26" x 11"	11"	6.9 kg	11.6"L x 11.6"W x 27.5"H	9.2/10.3kg	912
CARBON FILTER 8" x 39"	306123-0839	8" x 39" x 41" x 11"	11"	12 kg	11.6"L x 11.6"W x 43.2"H	14.8/14.2kg	1520
CARBON FILTER 10" x 24"	306123-1024	10" x 24" x 26" x 13"	13"	10.4 kg	13.4"L x 13.4"W x 27.4"H	12.9/14.5kg	950
CARBON FILTER 10" x 39"	306123-1039	10" x 39" x 41" x 13"	13"	17.5 kg	13.4"L x 13.4"W x 43.2"H	22.5/24.2kg	1560
CARBON FILTER 12" x 39"	306123-1239	12" x 39" x 41" x 15"	15"	20.7 kg	15.9"L x 15.9"W x 43.2"H	30.5/32.3kg	1800
CARBON FILTER 12" x 48"	306123-1248	12" x 48" x 50" x 17"	17"	28 kg	17.6"L x 17.6"W x 51.1"H	42.9/44.7kg	3000

BLACK BEAUTY SERIES CARBON BED 2 INCH

- Cone shaped base funnels air flow into filter
- Highly effective, low density virgin carbon
- Machine packed carbon enables 100% filtered air flow
- Inner and outer mesh provides 53% open area allowing increased air flow
- Includes changeable Velcro pre-filter
- Switchable filter flange and base for longer lifetime
- Large selection of sizes available to fit any application



ALUMINUM TOPS AND BASES
FOR REDUCED WEIGHT

INNER AND OUTER MESH
PROVIDES 53% OPEN AREA
ALLOWING INCREASED
AIR FLOW

HIGHLY EFFECTIVE, LOW
DENSITY VIRGIN CARBON

REVERSIBLE FLANGE AND
BASE FOR AN EXTENDED
SERVICE LIFE



Carbon filter belts



DESCRIPTION	ORDER CODE	SIZE IN INCH	SIZE IN MM	CARBON BED DEPTH	AIRFLOW		WEIGHT	PACKAGING DIMENSIONS
					CMH	CFM	LBS	
BLACK BEAUTY SERIES 4" x 8"	306153-0408	4" x 8"	Φ100×200 MM	8"	255	150	--	--
BLACK BEAUTY SERIES 4" x 12"	306153-0412	4" x 12"	Φ100×300 MM	8"	340	200	8.2	7.9"L x 7.9"W x 15"H
BLACK BEAUTY SERIES 4" x 20"	306153-0420	4" x 20"	Φ100×500 MM	8"	595	350	10.3	7.9"L x 7.9"W x 21.1"H
BLACK BEAUTY SERIES 5" x 16"	306153-0516	5" x 16"	Φ125×500 MM	9"	--	--	--	10.4"L x 10.4"W x 17.1"H
BLACK BEAUTY SERIES 5" x 20"	306153-0520	5" x 20"	Φ125×500 MM	9"	--	--	--	10.4"L x 10.4"W x 21.1"H
BLACK BEAUTY SERIES 5" x 24"	306153-0524	5" x 24"	Φ125×500 MM	9"	--	--	--	10.4"L x 10.4"W x 2.5"H
BLACK BEAUTY SERIES 6" x 12"	306153-0612	6" x 12"	Φ150×300 MM	10"	468	275	--	--
BLACK BEAUTY SERIES 6" x 16"	306153-0616	6" x 16"	Φ150×400 MM	10"	680	400	--	--
BLACK BEAUTY SERIES 6" x 20"	306153-0620	6" x 20"	Φ150×500 MM	10"	765	450	17.4	11.4"L x 11.4"W x 21.1"H
BLACK BEAUTY SERIES 6" x 24"	306153-0624	6" x 24"	Φ150×600 MM	10"	935	550	24.0	11.4"L x 11.4"W x 25"H
BLACK BEAUTY SERIES 6" x 39"	306153-0639	6" x 39"	Φ150×1000 MM	10"	1360	800	43.0	11.4"L x 11.4"W x 40.8"H
BLACK BEAUTY SERIES 8" x 24"	306153-0824	8" x 24"	Φ200×600 MM	12"	1275	750	25.1	13.5"L x 13.5"W x 25"H
BLACK BEAUTY SERIES 8" x 39"	306153-0839	8" x 39"	Φ200×1000 MM	12"	1615	950	42.5	13.4"L x 13.5"W x 40.8"H
BLACK BEAUTY SERIES 10" x 24"	306153-1024	10" x 24"	Φ250×600 MM	14"	1445	850	32.6	15.4"L x 15.4"W x 25.0"H
BLACK BEAUTY SERIES 10" x 39"	306153-1039	10" x 39"	Φ250×1000 MM	14"	2380	1400	53	15.4"L x 15.4"W x 40.8"H
BLACK BEAUTY SERIES 12" x 39"	306153-1239	12" x 39"	Φ300×1000 MM	16"	2890	1700	54	17.4"L x 17.4"W x 40.8"H
BLACK BEAUTY SERIES 12" x 48"	306153-1248	12" x 48"	Φ300×1200 MM	16"	3740	2200	71.2	17.4"L x 17.4"W x 48.7"H

ECONOMICAL TYPE CARBON FILTER

- Highly effective, low density columnar charcoal
- Machine packed carbon enables 100% filtered air flow
- Inner and outer mesh provides 53% open area allowing increased air flow
- Includes Velcro pre-filter
- Large selection of sizes available to fit any application



DESCRIPTION	ORDER CODE	SIZE IN INCH	CARBON BED DEPTH	FEATURE
ECONOMICAL TYPE CARBON FILTER 4" x 8"	306133-0408	4" x 8"	6.4"	COLUMNAR CHARCOAL CORROSION-RESISTANT GALVANIZED STEEL VELCRO PRE-FILTER HIGH GRADE ACTIVATED CHARCOAL OVER BOXED IN CORRUGATED CARDBOARD
ECONOMICAL TYPE CARBON FILTER 4" x 10"	306133-0410	4" x 10"	6.4"	
ECONOMICAL TYPE CARBON FILTER 4" x 12"	306133-0412	4" x 12"	6.4"	
ECONOMICAL TYPE CARBON FILTER 6" x 12"	306133-0612	6" x 12"	8.4"	
ECONOMICAL TYPE CARBON FILTER 6" x 20"	306133-0620	6" x 20"	8.4"	
ECONOMICAL TYPE CARBON FILTER 6" x 24"	306133-0624	6" x 24"	8.4"	
ECONOMICAL TYPE CARBON FILTER 8" x 24"	306133-0824	8" x 24"	10.4"	
ECONOMICAL TYPE CARBON FILTER 8" x 39"	306133-0839	8" x 39"	10.4"	
ECONOMICAL TYPE CARBON FILTER 10" x 39"	306133-1039	10" x 39"	12.4"	
ECONOMICAL TYPE CARBON FILTER 12" x 39"	306133-1239	12" x 39"	14.6"	

INLINE DUCT SILENCER

- 4"-12" sizes available
- Sound reducing acoustic foam decreases fan noise by up to 50%
- Easy to connect to the air power equipment without affect airflow

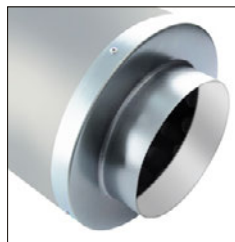

Detail pic



DESCRIPTION	ORDER CODE	DIAMETER	LENGTH	PACKAGING DIMENSIONS
INLINE DUCT SILENCER 4" x 12"	331601-4	4"	11.9"	7.32" x 7.32" x 16.54"
INLINE DUCT SILENCER 6" x 18"	331601-6	6"	23.6"	9.45" x 9.45" x 23.03"
INLINE DUCT SILENCER 8" x 24"	331601-8	8"	23.6"	11.58" x 11.58" x 28.94"
INLINE DUCT SILENCER 10" x 30"	331601-10	10"	30"	13.39" x 13.39" x 34.84"
INLINE DUCT SILENCER 12" x 36"	331601-12	12"	35.4"	15.95" x 15.95" x 40.75"

DUCTING / ACCESSORIES

BLACK-INSIDE FOIL DUCTING

- Air-tight, easy to install, and resists tearing and punctures
- Black inner core helps reduce light transfer
- Smooth interior aids in noise reduction
- Made with heavy duty materials



DESCRIPTION	ORDER CODE	WEIGHT LBS	PACKAGING DIMENSIONS
BLACK-INSIDEFOIL DUCTING 4"	306124-4	2.0	4.7"L x 4.7"W x 18.5"H
BLACK-INSIDEFOIL DUCTING 6"	306124-6	3.0	6.7"L x 6.7"W x 14.4"H
BLACK-INSIDEFOIL DUCTING 8"	306124-8	4.0	8.7"L x 8.7"W x 13.8"H
BLACK-INSIDEFOIL DUCTING 10"	306124-10	5.7	10.8"L x 10.8"W x 14.2"H
BLACK-INSIDEFOIL DUCTING 12"	306124-12	6.5	12.4"L x 12.4"W x 15.7"H
BLACK-INSIDEFOIL DUCTING 14"	306124-14	--	--

NON-INSULATED AIR DUCTING

- Durable construction for lasting performance, dual layer thickness
- Standard Length: 25 feet
- Price is negotiable for container load



DESCRIPTION	ORDER CODE	WEIGHT LBS	PACKAGING DIMENSIONS
NON-INSULATED AIR DUCT 4"	306104-4	2.0	4.7"L x 4.7"W x 18.5"H
NON-INSULATED AIR DUCT 6"	306104-6	3.0	6.7"L x 6.7"W x 14.4"H
NON-INSULATED AIR DUCT 8"	306104-8	4.0	8.7"L x 8.7"W x 13.8"H
NON-INSULATED AIR DUCT 10"	306104-10	5.7	10.8"L x 10.8"W x 14.2"H
NON-INSULATED AIR DUCT 12"	306104-12	6.5	12.4"L x 12.4"W x 15.7"H
NON-INSULATED AIR DUCT 14"	306104-14	--	--

NON-INSULATED AIR DUCT & STAINLESS STEEL CLAMPS



DESCRIPTION	ORDER CODE
NON-INSULATED AIR DUCT 4"W/2 PCS 4 IN STAINLESS STEEL CLAMPS	306104C-4
NON-INSULATED AIR DUCT 6"W/2 PCS 6 IN STAINLESS STEEL CLAMPS	306104C-6
NON-INSULATED AIR DUCT 8"W/2 PCS 8 IN STAINLESS STEEL CLAMPS	306104C-8
NON-INSULATED AIR DUCT 10"W/2 PCS 10 IN STAINLESS STEEL CLAMPS	306104C-10
NON-INSULATED AIR DUCT 12"W/2 PCS 12 IN STAINLESS STEEL CLAMPS	306104C-12
NON-INSULATED AIR DUCT 14"W/2 PCS 14 IN STAINLESS STEEL CLAMPS	306104C-14

COMBI FLEXIBLE DUCTING

- Durable construction for long lasting performance
- Dual layer thickness
- Flame-retardant
- Standard Length: 25 feet
- Price is negotiable for container load

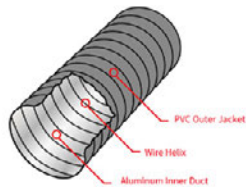

DESCRIPTION	ORDER CODE	WEIGHT LBS	PACKAGING DIMENSIONS
COMBI FLEXIBLE DUCTING 4"	306130-4	--	4.7"L x 4.7"W x 18.5"H
COMBI FLEXIBLE DUCTING 6"	306130-6	--	6.7"L x 6.7"W x 14.4"H
COMBI FLEXIBLE DUCTING 8"	306130-8	--	8.7"L x 8.7"W x 13.8"H
COMBI FLEXIBLE DUCTING 10"	306130-10	--	10.8"L x 10.8"W x 14.2"H
COMBI FLEXIBLE DUCTING 12"	306130-12	--	10.8"L x 10.8"W x 14.2"H
COMBI FLEXIBLE DUCTING 14"	306130-14	--	--

FULLY INSULATED DUCTING

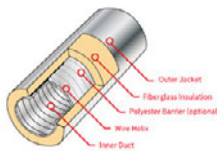

DESCRIPTION	ORDER CODE	WEIGHT LBS
FULLY INSULATED DUCTING 4"	306105-4	2.0
FULLY INSULATED DUCTING 6"	306105-6	2.7
FULLY INSULATED DUCTING 8"	306105-8	3.7
FULLY INSULATED DUCTING 10"	306105-10	5.7
FULLY INSULATED DUCTING 12"	306105-12	6.4
FULLY INSULATED DUCTING 14"	306105-14	--

ACOUSTIC DUCTING

- Heavy duty insulating material
- Reduces your grow room temperature

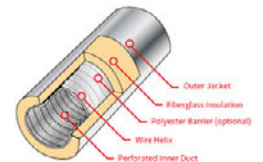

DESCRIPTION	ORDER CODE	WEIGHT LBS	PACKAGING DIMENSIONS
ACOUSTIC DUCTING 4"	306115-4	--	7.1"L x 7.1"W x 43.3"H
ACOUSTIC DUCTING 6"	306115-6	--	9.1"L x 9.1"W x 39.4"H
ACOUSTIC DUCTING 8"	306115-8	--	11.4"L x 11.4"W x 39.4"H
ACOUSTIC DUCTING 10"	306115-10	--	13"L x 13"W x 39.4"H
ACOUSTIC DUCTING 12"	306115-12	--	15"L x 15"W x 39.4"H
ACOUSTIC DUCTING 14"	306115-14	--	--

STAINLESS STEEL DUCT CLAMPS

- Stainless steel; rust resistant
- Worm drive adjustable for a super secure fit

DESCRIPTION	ORDER CODE	PACKAGING DIMENSIONS	CASE QTY
STAINLESS STEEL DUCT CLAMPS 4"	306106-4	13.8"(L) x 13.8"(W) x 20"(H)	500
STAINLESS STEEL DUCT CLAMPS 6"	306106-6	13.8"(L) x 13.8"(W) x 20"(H)	400
STAINLESS STEEL DUCT CLAMPS 8"	306106-8	14.6"(L) x 14.6"(W) x 16.5"(H)	250
STAINLESS STEEL DUCT CLAMPS 10"	306106-10	14.6"(L) x 14.6"(W) x 16.5"(H)	250
STAINLESS STEEL DUCT CLAMPS 12"	306106-12	14.6"(L) x 14.6"(W) x 16.5"(H)	250
STAINLESS STEEL DUCT CLAMPS 14"	306106-14	--	--



ALUMINUM DUCT TAPE

- A heavy duty heat resistant aluminum tape for repairing ducting Has pressure sensitive backing for durability and easy application Size: 30 Mil, 2.9 inch width, 50 meters long

MOQ: 200 PCS

DESCRIPTION	ORDER CODE	CASE QTY	SIZE	PACKAGING DIMENSIONS
ALUMINUM DUCT TAPE	306113	24	2.9" x 50M	14.6"(L) x 11"(W) x 12"(H)
ALUMINUM DUCT TAPE	306113-2	24	2.0" x 50M	14.6"(L) x 11"(W) x 12"(H)



HEAVY DUTY PEEL & STICK ZIPPER

- Self-adhesive, 7' long Smooth glide, large sturdy teeth, maximum durability
- Flap hooks hold-up door allowing easy entry and exit even when hands are full
- Works in temperatures below 55°F (12.8°C)

DESCRIPTION	ORDER CODE	PACKAGING DETAIL	SIZE
HEAVY DUTY PEEL & STICK ZIPPER	304866	1PC/BOX	3" WIDE



NOISE REDUCTION CLAMP

- Used with fans, carbon filters and ducting The neoprene lining makes for a tight, vibration free fit

MOQ: 100 PCS

DESCRIPTION	ORDER CODE	CASE QTY	PACKAGING DIMENSIONS
NOISE REDUCTION CLAMPS 4"	306107-4	200	47.2"(L) x 18.9"(W) x 12.2"(H)
NOISE REDUCTION CLAMPS 6"	306107-6	100	28.5"(L) x 11.4"(W) x 12.2"(H)
NOISE REDUCTION CLAMPS 8"	306107-8	50	43.3"(L) x 17.3"(W) x 12.2"(H)
NOISE REDUCTION CLAMPS 10"	306107-10	50	53.1"(L) x 21.3"(W) x 12.2"(H)
NOISE REDUCTION CLAMPS 12"	306107-12	50	43.9"(L) x 5.9"(W) x 12.2"(H)



Y DUCT CONNECTOR

- Made from heavier gauged galvanized steel than other fittings on the market

MOQ: 100 PC

DESCRIPTION	ORDER CODE	SIZE	CASE QTY	PACKAGING DIMENSIONS
Y DUCT CONNECTOR 4"	306108-444	4 x 4 x 4"	12	27.6"(L) x 11"(W) x 13"(H)
Y DUCT CONNECTOR 6"	306108-644	6 x 4 x 4"	12	31.1"(L) x 18.4"(W) x 18.9"(H)
Y DUCT CONNECTOR 6"	306108-666	6 x 6 x 6"	12	26.4"(L) x 13"(W) x 29.5"(H)
Y DUCT CONNECTOR 8"	306108-866	8 x 6 x 6"	12	29.1"(L) x 14.2"(W) x 29.5"(H)
Y DUCT CONNECTOR 8"	306108-888	8 x 8 x 8"	12	34.3"(L) x 14.6"(W) x 34.3"(H)
Y DUCT CONNECTOR 10"	306108-1088	10 x 8 x 8"	6	28.7"(L) x 15"(W) x 27.6"(H)
Y DUCT CONNECTOR 12"	306108-121010	12 x 10 x 10"	6	32.7"(L) x 16.9"(W) x 26"(H)
Y DUCT CONNECTOR 12"	306108-121212	12 x 12 x 12"	4	25.2"(L) x 18.9"(W) x 29.9"(H)



REDUCER

- Made from a heavier gauge galvanized steel than competitive fittings corrugated boxes to protect them & for easy handling

DESCRIPTION	ORDER CODE	SIZE	PACKAGING DIMENSIONS	CASE QTY
REDUCER 4"	306109-4	6 x 4"	13.8"(L) x 7.1"(W) x 33.5"(H)	24
REDUCER 6"	306109-6	8 x 6"	17.7"(L) x 9.1"(W) x 30.7"(H)	24
REDUCER 8"	306109-8	10 x 8"	21.7"(L) x 11"(W) x 17.7"(H)	12
REDUCER 10"	306109-10	12 x 10"	25.6"(L) x 13"(W) x 17.7"(H)	12
REDUCER 12"	306109-12	14 x 12"	29.9"(L) x 15.4"(W) x 17.7"(H)	12



MOQ: 100 PCS

BACKDRAFT DAMPER

- Manufactured with quality components and precision engineering

DESCRIPTION	ORDER CODE	SIZE	CASE QTY
BACKDRAFT DAMPER 4"	306110-4	4"	80
BACKDRAFT DAMPER 6"	306110-6	6"	64
BACKDRAFT DAMPER 8"	306110-8	8"	48
BACKDRAFT DAMPER 10"	306110-10	10"	36
BACKDRAFT DAMPER 12"	306110-12	12"	24

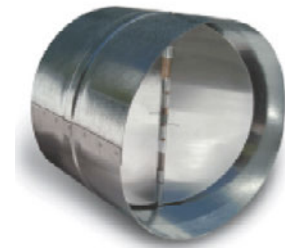

MOQ: 100 PCS

CONNECTOR DUCT



MOQ: 100 PCS

DESCRIPTION	ORDER CODE	SIZE
CONNECTOR 4"	306111-4	4"
CONNECTOR 6"	306111-6	6"
CONNECTOR 8"	306111-8	8"
CONNECTOR 10"	306111-10	10"
CONNECTOR 12"	306111-12	12"

ELBOW DUCT



MOQ: 100 PCS

DESCRIPTION	ORDER CODE	SIZE
ELBOW 4"	306112-4	4"
ELBOW 6"	306112-6	6"
ELBOW 8"	306112-8	8"
ELBOW 10"	306112-10	10"
ELBOW 12"	306112-12	12"

DUCT COLLAR



MOQ: 100 PCS

DESCRIPTION	ITEM NO.	SIZE
DUCT COLLAR 4"	306117-4	4"
DUCT COLLAR 6"	306117-6	6"
DUCT COLLAR 8"	306117-8	8"
DUCT COLLAR 10"	306117-10	10"
DUCT COLLAR 12"	306117-12	12"
DUCT COLLAR 14"	306117-14	14"
DUCT COLLAR 16"	306117-16	16"

SCREENED WALL VENTS



MOQ: 100 PCS

DESCRIPTION	ORDER CODE	SIZE
SCREENED WALL VENTS 4"	306118-4	4"
SCREENED WALL VENTS 6"	306118-6	6"
SCREENED WALL VENTS 8"	306118-8	8"
SCREENED WALL VENTS 10"	306118-10	10"
SCREENED WALL VENTS 12"	306118-12	12"
SCREENED WALL VENTS 14"	306118-14	14"
SCREENED WALL VENTS 16"	306118-16	16"

CO2 GENERATORS

- Available in both propane or natural gas models with 4 burners or 8 burners
- Electronic Spark Ignition (ESI)- No pilot light necessary
- Safety "tip-over" switch shuts down propane or natural gas in case the CO2 generator falls or gets knocked over
- Constructed of powder-coated steel to prevent rust and discoloration
- 2 Amps/120 Volts/60 Hz



Pic 1



Pic 2



Pic 3

DESCRIPTION	ORDER CODE	VOLTAGE FREQUENCY	CURRENT A	RECOMMENDED AREA	INCLUDED ACCESSORIES	WEIGHT LBS	PACKAGING DIMENSIONS
CO2 GENERATOR (PROPANE/4 BURNERS)	306114-LP4	120V/60HZ	2.0	---	---	18.4	14.8"(L) x 12.2"(W) x 20.3"(H)
CO2 GENERATOR (PROPANE/8 BURNERS)	306114-LP8	120V/60HZ	2.0	---	---	24.5	20.1"(L) x 12.4"(W) x 20.4"(H)
CO2 GENERATOR (NATURAL GAS/4 BURNERS)	306114-NG4	120V/60HZ	2.0	---	---	---	14.8"(L)x 12.2"(W) x 20.3"(H)
CO2 GENERATOR (NATURAL GAS/8 BURNERS)	306114-NG8	120V/60HZ	2.0	---	---	---	20.1"(L) x 12.4"(W) x 20.4"(H)

CO2 REGULATOR

- 40mm high pressure gauge : 0-4000psi
 - Flowmeter: 0-15 scfh
 - Inlet connection: cga-320
 - Hose tail: suitable for 4.2 mm inside diameter hose
 - With solenoid valve and USA standard plug
- MOQ: 50 PCS



DESCRIPTION	ORDER CODE	MATERIAL	CURRENT A	RECOMMENDED AREA	WEIGHT LBS	PACKAGING DIMENSIONS
CO2 REGULATOR	306214	BRASS	---	---	---	18.9"(L) x 13.8"(W) x 12.6"(H)

FABRIC POT

- Constructed from high quality Nonwoven fabric
- Provides great support, while allowing air to travel into the root system
- Improves drainage and provides increased airflow to prevent root system from overheating on hot days
- Provide rapid establishment after transplanting
- Handles are included on all size



DESCRIPTION	ORDER CODE	SIZE	WEIGHT	HEIGHT	DIAMETER
FABRIC POT 1 GALLON	311001-01	1 GALLON	260G	7.8"	6.3"
FABRIC POT 2 GALLON	311001-02	2 GALLON	260G	7.8"	7.8"
FABRIC POT 3 GALLON	311001-03	3 GALLON	260G	9.8"	9.4"
FABRIC POT 5 GALLON	311001-05	5 GALLON	260G	9.8"	11.8"
FABRIC POT 7 GALLON	311001-07	7 GALLON	260G	9.8"	13.8"
FABRIC POT 10 GALLON	311001-10	10 GALLON	260G	11.8"	15.7"
FABRIC POT 15 GALLON	311001-15	15 GALLON	260G	11.8"	19.7"
FABRIC POT 20 GALLON	311001-20	20 GALLON	260G	15.7"	20.0"
FABRIC POT 25 GALLON	311001-25	25 GALLON	260G	15.7"	21.6"
FABRIC POT 30 GALLON	311001-30	30 GALLON	260G	15.7"	23.6"
FABRIC POT 45 GALLON	311001-45	45 GALLON	260G	17.7"	26.8"
FABRIC POT 65 GALLON	311001-65	65 GALLON	---	17.7"	29.5"
FABRIC POT 75 GALLON	311001-75	75 GALLON	---	19.0"	32.6"
FABRIC POT 100 GALLON	311001-100	100 GALLON	---	19.0"	39.0"
FABRIC POT 150 GALLON	311001-150	150 GALLON	---	23.6"	43.0"
FABRIC POT 200 GALLON	311001-200	200 GALLON	---	23.6"	50.0"
FABRIC POT 300 GALLON	311001-300	300 GALLON	---	23.6"	60.0"
FABRIC POT 400 GALLON	311001-400	400 GALLON	---	23.6"	70.0"

TAN FABRIC POT

- Constructed from high quality fabric
- Provides great support, while allowing air to travel into the root system
- Improves drainage and provides increased airflow to prevent root system from overheating on hot days
- Provide rapid establishment after transplanting



DESCRIPTION	ORDER CODE	SIZE	HEIGHT	DIAMETER
TAN FABRIC POT 1 GALLON	311011-001	1 GALLON	7.8"	6.3"
TAN FABRIC POT 2 GALLON	311011-002	2 GALLON	7.8"	7.8"
TAN FABRIC POT 3 GALLON	311011-003	3 GALLON	9.8"	9.4"
TAN FABRIC POT 5 GALLON	311011-005	5 GALLON	9.8"	11.8"
TAN FABRIC POT 7 GALLON	311011-007	7 GALLON	11.8"	13.8"
TAN FABRIC POT 10 GALLON	311011-010	10 GALLON	11.8"	15.7"
TAN FABRIC POT 15 GALLON	311011-015	15 GALLON	11.8"	19.7"
TAN FABRIC POT 20 GALLON	311011-020	20 GALLON	11.8"	20.0"
TAN FABRIC POT 25 GALLON	311011-025	25 GALLON	15.7"	21.6"
TAN FABRIC POT 30 GALLON	311011-030	30 GALLON	15.7"	23.6"
TAN FABRIC POT 50 GALLON	311011-050	50 GALLON	17.7"	27.5"
TAN FABRIC POT 65 GALLON	311011-065	65 GALLON	17.7"	29.5"
TAN FABRIC POT 75 GALLON	311011-075	75 GALLON	18.9"	32.7"
TAN FABRIC POT 100 GALLON	311011-100	100 GALLON	18.9"	38.9"
TAN FABRIC POT 150 GALLON	311011-150	150 GALLON	23.6"	42.9"
TAN FABRIC POT 200 GALLON	311011-200	200 GALLON	23.6"	50.0"
TAN FABRIC POT 300 GALLON	311011-300	300 GALLON	23.6"	60.0"
TAN FABRIC POT 400 GALLON	311011-400	400 GALLON	23.6"	70.0"

TRANSPLANTING GROW BAG - 1 GALLON



- Constructed from sturdy, high-quality nonwoven fabric
- Perfect balance of aeration, drainage and water absorption
- Strong velcro side seam for easy transplanting
- Strap handles and rigidity eliminate transplant shock
- Perfect height x diameter ratio: 5.5" x 7"

DESCRIPTION	ORDER CODE	COLOR	PACKAGING DIMENSIONS	FEATURE
TRANSPLANTING GROW BAG 1 GALLON	311041-001	BLACK	5.5" X 7"	NONWOVEN FABRIC

PRO TAN POT

- Highly firm handles
- BPA free and eco friendly
- 15% thicker material than the normal one



DESCRIPTION	ORDER CODE	SIZE	HEIGHT	DIAMETER
PRO TAN POT 1 GALLON, NO HANDLES, 5/PK	311021-001	1 GALLON	7.8"	6.3"
PRO TAN POT 2 GALLON, NO HANDLES, 5/PK	311021-002	2 GALLON	7.8"	7.8"
PRO TAN POT 3 GALLON, NO HANDLES, 5/PK	311021-003	3 GALLON	9.8"	9.4"
PRO TAN POT 5 GALLON, WITH HANDLES, 5/PK	311021-005	5 GALLON	9.8"	11.8"
PRO TAN POT 7 GALLON, WITH HANDLES, 5/PK	311021-007	7 GALLON	11.8"	11.8"
PRO TAN POT 10 GALLON, WITH HANDLES, 5/PK	311021-010	10 GALLON	11.8"	15.7"
PRO TAN POT 15 GALLON, WITH HANDLES, 5/PK	311021-015	15 GALLON	11.8"	19.7"
PRO TAN POT 20 GALLON, WITH HANDLES, 5/PK	311021-020	20 GALLON	15.7"	20.0"
PRO TAN POT 25 GALLON, WITH HANDLES, 5/PK	311021-025	25 GALLON	15.7"	21.6"
PRO TAN POT 30 GALLON, WITH HANDLES, 5/PK	311021-030	30 GALLON	15.7"	23.6"
PRO TAN POT 45 GALLON, WITH HANDLES, 5/PK	311021-045	45 GALLON	17.7"	26.8"
PRO TAN POT 50 GALLON, WITH HANDLES, 5/PK	311021-050	50 GALLON	15.3"	28.7"
PRO TAN POT 65 GALLON, WITH HANDLES, 5/PK	311021-065	65 GALLON	15.3"	28.7"
PRO TAN POT 75 GALLON, WITH HANDLES, 5/PK	311021-075	75 GALLON	18.9"	32.7"
PRO TAN POT 100 GALLON, WITH HANDLES, 5/PK	311021-100	100 GALLON	18.9"	38.9"
PRO TAN POT 150 GALLON, WITH HANDLES, 5/PK	311021-150	150 GALLON	23.6"	43.0"
PRO TAN POT 200 GALLON, WITH HANDLES, 5/PK	311021-200	200 GALLON	22.8"	47.2"
PRO TAN POT 300 GALLON, WITH HANDLES, 5/PK	311021-300	300 GALLON	22.8"	47.2"
PRO TAN POT 400 GALLON, WITH HANDLES, 5/PK	311021-400	400 GALLON	22.8"	47.2"

PLASTIC GROW BAG

- Durable, excellent quality grow bags
 - Available in 1 gallon to 30 gallon sizes
 - Holes in the bottom allow for proper drainage
 - Lead time will be longer for order less than 1000pcs
- MOQ: 5000 PCS



DESCRIPTION	ORDER CODE	SIZE
PLASTIC GROW BAG 1 GALLON	311007-1	1 GALLON
PLASTIC GROW BAG 2 GALLON	311007-2	2 GALLON
PLASTIC GROW BAG 3 GALLON	311007-3	3 GALLON
PLASTIC GROW BAG 5 GALLON	311007-5	5 GALLON
PLASTIC GROW BAG 7 GALLON	311007-7	7 GALLON
PLASTIC GROW BAG 10 GALLON	311007-10	10 GALLON
PLASTIC GROW BAG 20 GALLON	311007-20	20 GALLON
PLASTIC GROW BAG 30 GALLON	311007-30	30 GALLON

BLACK & WHITE PLASTIC GROW BAG

- Durable, excellent quality grow bags
 - Available in 1 gallon, 2 gallon, 3 gallon, 5 gallon
 - Holes in the bottom allow for proper drainage
- MOQ: 20000 PCS



DESCRIPTION	ORDER CODE	SIZE	PRODUCT DIMENSIONS
PLASTIC GROW BAG 1 GALLON	311008-01	1 GALLON	---
PLASTIC GROW BAG 2 GALLON	311008-02	2 GALLON	---
PLASTIC GROW BAG 3 GALLON	311008-03	3 GALLON	---
PLASTIC GROW BAG 5 GALLON	311008-05	5 GALLON	---

NEW PRODUCT

CARBON LINED GYM BAG

- Funk Fighter Bags use high-quality carbon to trap & lock in odors!
- The Large Gym Bag features the large main zippered compartment which has 2 layers of zippered openings for maximum odor-trapping capabilities and is waterproof
- The Gym bag also has zippered compartments on each end of the bag, an adjustable strap, and attached handles which can velcro together



Funk Fighter Carbon Lined Gym Bag XXL (Grey)



Odor Absorbing Bag XXL (black)



DESCRIPTION	ORDER CODE	COLOR	PACKAGING DIMENSIONS	FEATURE
FUNK FIGHTER CARBON LINED GYM BAG XXL (GREY)	331121	GREY	28" x 15" x 15"	HIGH-QUALITY CARBON LINING
ODOR ABSORBING BAG XXL (BLACK)	331131	BLACK	32" x 19" x 19"	HEAVY DUTY CONSTRUCTION H2O GUARD ZIPPER (WATER RESISTANT) INDUSTRIAL VELCRO

BUBBLE BAGS

- Long lasting high quality nylon material
- Built in cord for easy binding the bag after being extracted
- Corresponding color micron bags are labeled for proper order
- Different sized bags for filtering different grades of herbal resins



DESCRIPTION	ORDER CODE	SPECIFICATION & FEATURE
BUBBLE BAGS 8BAGS	311004-58 1SET=8BAGS	PACKAGE INCLUDES: TOTAL: (8) 5 GALLON FILTRATION BAGS: (1) PURPLE=25 micron (1) WHITE=45 micron (1) YELLOW=73 micron (1) BLACK=90 micron (1) ORANGE=120 micron (1) RED=160 micron (1) GREEN=190 micron (1) BLUE=220 micron
BUBBLE BAGS 5BAGS	311004-55 1SET=5BAGS	PACKAGE INCLUDES: TOTAL: (5) 5 GALLON FILTRATION BAGS: (1) PURPLE=25 micron (1) YELLOW=73 micron (1) ORANGE=120 micron (1) RED=160 micron (1) BLUE=220 micron
BUBBLE BAGS 4BAGS	311004-54 1SET=4BAGS	PACKAGE INCLUDES: TOTAL: (4) 5 GALLON FILTRATION BAGS: (1) PURPLE=25 micron (1) YELLOW=73 micron (1) RED=160 micron (1) BLUE=220 micron
BUBBLE BAGS 3BAGS	311004-53 1SET=3BAGS	PACKAGE INCLUDES: TOTAL:(3) 5 GALLON FILTRATION BAGS: (1) PURPLE=25 micron (1) YELLOW=73 micron (1) BLUE=220 micron
BUBBLE BAGS 8BAGS	311004-18 1SET=8BAGS	PACKAGE INCLUDES: TOTAL: (8) 1 GALLON FILTRATION BAGS: (1) PURPLE=25 micron (1) WHITE=45 micron (1) YELLOW=73 micron (1) BLACK=90 micron (1) ORANGE=120 micron (1) RED=160 micron (1) GREEN=190 micron (1) BLUE=220 micron
BUBBLE BAGS 4BAGS	311004-14 1SET=4BAGS	PACKAGE INCLUDES: TOTAL: (4) 1 GALLON FILTRATION BAGS: (1) PURPLE=25 micron (1) WHITE=73 micron (1) RED=160 micron (1) BLUE=220 micron

GARDENING ACCESSORIES

PLASTIC SAUCERS

- Durable, non-toxic and odorless, Material : PP
MOQ: Per pallet quantity



Available in other sizes

DESCRIPTION	ORDER CODE	SIZE	PLT QTY	DIAMETER (IN)	BOTTOM (IN)	HEIGHT (IN)
PLASTIC SAUCERS	330501-5	5"	600	6.2	5.0	0.8
PLASTIC SAUCERS	330501-6	6"	400	7.6	6.0	0.8
PLASTIC SAUCERS	330501-8	8"	200	10	8.1	1
PLASTIC SAUCERS	330501-10	10"	150	11.8	9.6	1.2
PLASTIC SAUCERS	330501-12	12"	150	14.6	12.2	1.4
PLASTIC SAUCERS	330501-13	13"	80	16	13.5	1.4
PLASTIC SAUCERS	330501-15	15"	80	17.6	14.9	1.8

PLASTIC POTS

- Durable, non-toxic and odorless; Material : PP
- Drainage holes type: side holes
MOQ: Per pallet quantity



DESCRIPTION	ORDER CODE	TOP DIM	BOTTOM DIM	HEIGHT	PALLET SIZE (PCS)	PALLET PACKAGE (PCS)	QTY / 40HC (PCS)
PREMIUM NURSERY POT 1	330511-1	6.8"	5.1"	6.7"	45" x 45"	9310	186200
PREMIUM NURSERY POT 2	330511-2	8.6"	6.6"	8.5"	43" x 43"	5000	100000
PREMIUM NURSERY POT 3	330511-3	10.2"	7.8"	9.6"	45" x 45"	1760	35200
PREMIUM NURSERY POT 5	330511-5	12.6"	9.4"	11.4"	39" x 52"	1008	21168
PREMIUM NURSERY POT 7	330511-7	14"	11.4"	11.4"	43" x 43"	846	18612
PREMIUM NURSERY POT 10	330511-10	16.3"	13.3"	11.8"	50" x 33"	558	12834
PREMIUM NURSERY POT 15	330511-15	18.5"	14.3"	15"	38" x 38"	312	7488
PREMIUM NURSERY POT 20	330511-20	22.6"	17.2"	17"	45" x 45"	196	3920
PREMIUM NURSERY POT 25	330511-25	24.2"	18.3"	16.7"	38" x 47"	104	3480

PREMIUM BLACK SQUARE POT & SQUARE SAUCER

DESCRIPTION	ORDER CODE	GALLON	WIGHT (G)	SIZE	PCS/CTN	MEAS
SQUARE PLASTIC POT	330512-5.5	1.4 GAL	128	6" x 6" x 8"	120	18.1" x 12.5" x 25.5"
PREMIUM BLACK SQUARE POT	330512-7	1.8 GAL	206	7" x 7" x 9"	100	15.7" x 15.7" x 33.5"
PREMIUM BLACK SQUARE POT	330512-11	3 GAL	265	9" x 9" x 11"	70	9.5" x 18.5" x 44.7"
SQUARE SAUCER FOR 7L	330513-7	--	54	8" x 8" x 0.7"	--	--
SQUARE SAUCER FOR 11L	330513-11	--	76	10" x 10" x 0.8"	--	--



HEAVY DUTY SAUCER



MOQ: 5000 PCS

DESCRIPTION	ORDER CODE	PRODUCT DIMENSIONS O.D.xI.D.xH	MATERIAL	COLOR	PRODUCT WEIGHT	PACKAGING DIMENSIONS	N.W. / G.W.	CASE QTY
HEAVY DUTY SAUCER 6"	330502-6	7.0" x 1.2" Bott O.D.: 5.7"	PP	GREEN	42	0.040M ³ /BAG 14.6" x 14.6" x 12.9"	4.2 / 5.2KG	300
HEAVY DUTY SAUCER 8"	330502-8	9.4" x 1.5" Bott O.D.: 8.0"	PP	GREEN	88	0.040M ³ /BAG 10.0" x 19.3" x 9.6"	8.8 / 10.3KG	100
HEAVY DUTY SAUCER 10"	330502-10	11.0" x 1.8" Bott O.D.: 9.6"	PP	GREEN	128	0.040M ³ /BAG 11.6" x 22.6" x 10.6"	12.8 / 14.3KG	100
HEAVY DUTY SAUCER 12"	330502-12	13.8" x 2.0" Bott O.D.: 12.2"	PP	GREEN	208	0.040M ³ /BAG 14.4" x 14.4" x 21.5"	20.8 / 22.8KG	100
HEAVY DUTY SAUCER 14"	330502-14	15.7" x 2.2" Bott O.D.: 14"	PP	GREEN	262	0.040M ³ /BAG 16.3" x 16.3" x 21"	26.2 / 28.2KG	100
HEAVY DUTY SAUCER 16"	330502-16	18.1" x 2.4" Bott O.D.: 16.1"	PP	GREEN	402	0.040M ³ /BAG 18.7" x 18.7" x 21.9"	40.2 / 42.2KG	100

HIGH DOME PROPAGATOR 10" X 20"



- Increases the humidity and moisture; therefore seeds will germinate much faster under a optimum surrounding. Straight vertical sides allow use of all plant sites in a propagation tray
- 2 vents in the top of the dome can be opened or closed (The cover and tray can be sold divdually)

DESCRIPTION	ORDER CODE	SIZE	COLOR	MATERIAL	PACKAGING
HIGH DOME PROPAGATOR 21.3" x 10.9" x 10"	330812	21.3" x 10.9" x 10"	BLACK & TRANSPARENT	PVC	25PC/CTN
HEAVY DUTY CUT KIT TRAY 21.3" x 10.9" x 2.8"	330813	21.3" x 10.9" x 2.8"	BLACK	PVC	25PC/CTN
HIGH DOME PROPAGATOR 10" x 10" x 4.3"	330815	10" x 10" x 4.3"	BLACK & TRANSPARENT	PVC	100PC/CTN

PROPAGATION TRAY



DESCRIPTION	ORDER CODE	HOLES	NET WEIGHT	THICKNESS	G.W.	N.W.	PRODUCT SIZE	PACKAGING SIZE	MOQ	CASE QTY
HIGH DOME PROPAGATOR	330801-72	72	135g+5	1.0MM	19.6KGS	19.2KGS	21.2" x 11" x 1.8"	12.4" x 11.4" x 21.6"	1000PCS	150PCS
HIGH DOME PROPAGATOR	330802-128	128	135g+5	1.0MM	18.2KGS	17.8KGS	21.2" x 11" x 1.6"	12.4" x 11.4" x 21.6"	1000PCS	130PCS
HIGH DOME PROPAGATOR	330803-200	200	135g+5	1.0MM	18.2KGS	17.8KGS	21.2" x 11" x 1.5"	12.4" x 11.4" x 21.6"	1000PCS	130PCS

ROOT AIR POT / ROOTBUILDER

- Allows roots reaching towards the container wall to find the air holes immediately
 - Make the directed root virtually impossible to escape root tip pruning
 - Keeping plant's root system much cooler
- MOQ: 1000PCS



DESCRIPTION	ORDER CODE	CAPACITY	DIMENSION SIZE	CARTON SIZE	MATERIAL	THICKNESS
ROOTBUILDER 1 GALLON	330901-1	1 GALLON	8" x H6"	25.7" x 5.9" x 9.4"	HDPE	0.8MM
ROOTBUILDER 2 GALLON	330901-2	2 GALLON	8" x H10"	25.7" x 9.8" x 9.4"	HDPE	0.8MM
ROOTBUILDER 3 GALLON	330901-3	3 GALLON	10" x H10"	31.8" x 9.8" x 6.6"	HDPE	0.8MM
ROOTBUILDER 5 GALLON	330901-5	5 GALLON	12" x H12"	38.1" x 11.8" x 6.6"	HDPE	0.8MM
ROOTBUILDER 7 GALLON	330901-7	7 GALLON	12" x H14"	38.1" x 13.7" x 7"	HDPE	0.8MM
ROOTBUILDER 12.7 GALLON	330901-12.7	12.7 GALLON	15.7" x H15.7"	50.4" x 15.7" x 4.7"	HDPE	0.8MM
ROOTBUILDER 14 GALLON	330901-14	14 GALLON	15.7" x H17.7"	50.4" x 17.7" x 4.7"	HDPE	0.8MM
ROOTBUILDER 20 GALLON	330901-20	20 GALLON	19.7" x H15.7"	62.8" x 15.7" x 3.1"	HDPE	0.8MM

TOOLLESS ASSEMBLY TRAY STANDS



- Heavy duty 4 ft x 4 ft & 4 ft x 8 ft quick assembly tray stands
- Absolutely no tools required
- Can be assembled in 5 minutes or less
- Accommodates all popular brand trays and reservoirs
- Height from bottom bar to floor is 26.5 in without casters
- Inside dimensions: 100 in length by 51 in width



DETAIL



1' HEIGHT EXTENSION KIT

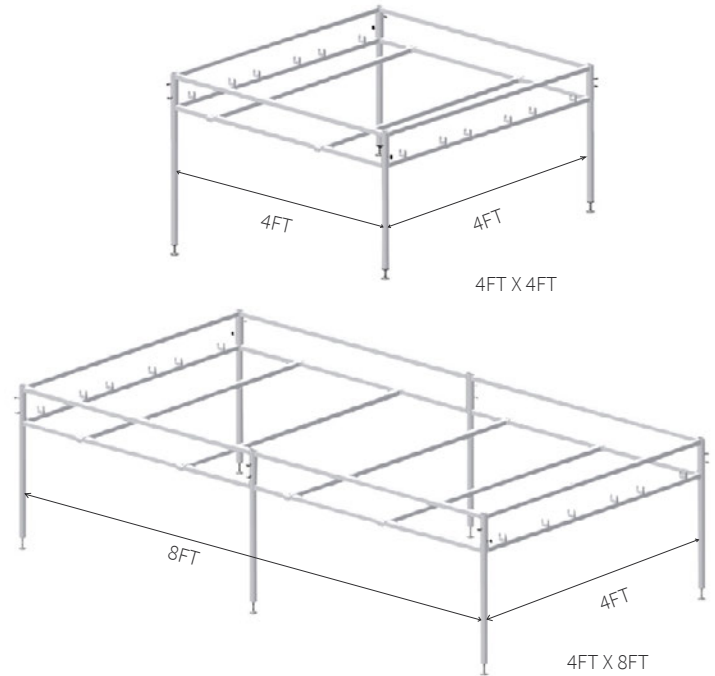

CUSTOMIZE TO SUIT YOUR NEEDS.



HEAVY-DUTY STEEL



POWDER-COATED PROTECTION



NO TOOLS REQUIRED



MOVE & LOCK



ALL TRAYS WELCOMED



LIGHT STAND KIT UPRIGHT 4FT



LOCKING CASTER WHEELS FOR STABILITY & EASE OF MOBILITY

CASTER WHEELS

DESCRIPTION	ORDER CODE	MATERIAL	PRODUCT DIMENSIONS	PACKAGING DIMENSIONS	N.W.	G.W.	CASE QTY
TRAY STAND 4 FT X 4 FT WITH 12 IN HEIGHT EXTENSION LEG KIT	330831	POWER-COATED STEEL	53"L x 53"W x 26.5"H	54"L x 7.9"W x 7.3"H	22 KG	23 KG	1
TRAY STAND 4 FT X 8 FT WITH 12 IN HEIGHT EXTENSION LEG KIT	330832	POWER-COATED STEEL	102"L x 53"W x 26.5"H	54"L x 7.9"W x 9.8"H	33 KG	34 KG	1
LIGHT STAND KIT UPRIGHT 4FT - 4PCS	330841	POWER-COATED STEEL	N.A	N.A	3.3 KG	3.5 KG	1
LIGHT STAND KIT UPRIGHT 4FT - 6PCS	330842	POWER-COATED STEEL	N.A	N.A	3.3 KG	3.5 KG	1
CASTER WHEELS - 4 PCS	330843	STEEL	N.A	5"L x 5"W x 5.5"H	0.8 KG	0.9 KG	1
CASTER WHEELS - 6 PCS	330844	STEEL	N.A	5"L x 5"W x 5.5"H	1.2 KG	1.35 KG	1

GARDENING ACCESSORIES

DELUXE MIST & SPRAY, 2.0 L

- Packing: 15pcs/ctn
- Specification: 2500ml
- Meas.: 26.6"x15.9"x11.8"
- M³/ctn:0.0820
- G.W.: 7.5Kg
- N.W.: 7.0Kg
- Order code: 311005-1



DELUXE MIST & SPRAY, 1.2 L

- Pakcing: 20pcs/ctn
- Specification: 1500ml
- Meas.: 23.2"x17.9"x12.4"
- M³/ctn:0.0846
- G.W.: 6.7Kgs
- N.W.: 6.0Kgs
- Order code: 311005-2



DRYING RACK

- Medium is 24" diameter and large is 32" diameter
- Order code: 311002-1 (medium)
- Order code: 311002-2 (large)



STACKABLE DRYING RACKS

- Used to easily dry flowers and herbs
- Durable polyester netting
- Retractable mesh for easy access
- Dimensions: 27.5"L x 27.5"W x 32.25"H
- Order code: 311006



WIRE CAGE (TOMATO CAGE)

- Stackable & compact for seasonal storage;
- Endless uses for vegetables & flowers
- Great for container gardening; Keeps plants from falling over



DESCRIPTION	ORDER CODE	MATERIAL	PRODUCT WEIGHT	PACKAGE	PACKAGE SIZE	N.W./G.W.	MOQ
WIRE CAGE (TOMATO CAGE 36" AT 10"/12"/14")	335201	STEEL BRACKET 0.1" DIAMETER GALVANIZED STEEL	360G	25PCS/PILE	DIA 14"x7.22'/100PCS	360G	3000
WIRE CAGE (TOMATO CAGE 48" AT 8"/10"/12"/14")	335202	STEEL BRACKET 0.1" DIAMETER GALVANIZED STEEL	410G	25PCS/PILE	DIA 14"x7.22'/90PCS	410G	3000
WIRE CAGE (TOMATO CAGE 60" AT 10"/12"/14"/16")	335203	STEEL BRACKET 0.1" DIAMETER GALVANIZED STEEL	500G	25PCS/PILE	DIA 16"x7.22'/80PCS	500G	3000

BAMBOO STAKES

- Bamboo stakes are all natural, strong, lightweight, inexpensive, weather well and last several seasons in the garden
- Full container sales only

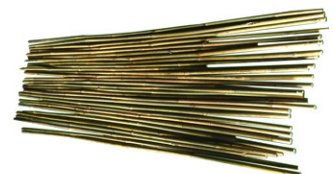

DESCRIPTION	ORDER CODE	SPECIFICATIONS	PACKAGE	N.W./G.W.	Case QTY	PACKAGING DIMENSIONS
BAMBOO STAKES 3 FT - 25PCS/PACK	332821	3', 0.39"-0.47" x 36.0" NATURAL BAMBOO	25PCS/PACK, 4PACK/BAG	2.9/3.2KG	100	0.01m ³
BAMBOO STAKES 4 FT - 25PCS/PACK	332822	4', 0.39"-0.47" x 48.0" NATURAL BAMBOO	25PCS/PACK, 4PACK/BAG	3.8/4.0KG	100	0.0134m ³
BAMBOO STAKES 5 FT - 25PCS/PACK	332823	5', 0.39"-0.47" x 60.0" NATURAL BAMBOO	25PCS/PACK, 4PACK/BAG	4.75/5.25KG	100	0.0165m ³
BAMBOO STAKES 6 FT - 25PCS/PACK	332824	6', 0.39"-0.47" x 72.0" NATURAL BAMBOO	25PCS/PACK, 4PACK/BAG	5.7/6.2KG	100	0.0195m ³
BAMBOO STAKES 8 FT - 25PCS/PACK	332825	8', 0.47"-0.55" x 96.0" NATURAL BAMBOO	25PCS/PACK, 4PACK/BAG	7.6/8.1KG	100	0.0289m ³

GARDENING ACCESSORIES

8" CLASSIC CUT BYPASS PRUNER



- 8" Classic Cut Bypass Pruner
- Packaging size: 10/50
- Order code: 332001

8" LONG STRAIGHT STAINLESS STEEL SNIP



- 8" Long Straight, Stainless Steel Snip
- Packaging size: 10/50
- Order code: 332002

7" FLOWER SNIP



- 7" Flower snip, alloy PP handle
- Packaging size: 12/48
- Quality alloy tool steel, 0.050cbm
- Order code: 332003

PRECISION PRUNER



- Surgical stainless steel with titanium coating
- High quality springs
- Order code: 311003-2

BONSAI SHEARS 1.5" STRAIGHT BLADES



- Product dimensions: 6.1"
- Blade Thickness: 0.098", coating: sanding
- Material: 2CR13+PP+TPR
- Product Weight: 60 g, N.W./G.W.: 7.5/6 kg
- Case QTY: 100
- Order code: 332020

BONSAI SHEARS 2.5" STRAIGHT BLADES



- Product dimensions: 7.3"
- Blade Thickness: 0.098", coating: sanding
- Material: 2CR13+PP+TPR
- Product Weight: 75 g, N.W./G.W.: 8.6/7.5 kg
- PACKAGING DIMENSIONS: 12.2" x 10.7" x 14.4"
- Case QTY: 100
- Order code: 332021

PRUNING SHEAR STEEL BLADE HAND PRUNER (STRAIGHT EDGESCISSORS)



- Surgical stainless steel with titanium coating
- High quality springs
- Order code: 311033-4



PRUNING SHEAR STEEL BLADE HAND PRUNER (CURVED BLADE SCISSORS)



- Ideal for gardening cutting and trimming
- Built-in safety lock
- Corrosion-resistant Titanium coated blades
- Order code: 311033-5



NOZZLE GUNS & WANDS



- Nozzle Guns & Wands
- 0.081cbm
- 9 Pattern Spray Wand, 15.9" (L)
- Packaging size: 24/48
- Order code: 332012

STANDARD HEDGE SHEARS



- Quality alloy tool steel blade with non-stick coating
- Adjustable blade tension, 0.041cbm
- Packaging size: 6/12
- Order code: 332004

10" FOLDING SAW



- Japanese SK5 steel blade with 3 times ground teeth, safety lock
- Size: total 22.4"
- 0.054 cbm, blade: 10.2"(L)
- Packaging size: 12/24
- Order code: 332006

PRUNING SAW



- Japanese SK5 steel blade with 3 times ground teeth pull saw, nylon handle
- Size: total 20.5" (L), blade 35cm (L)
- 0.078cbm
- Packaging size: 12/48
- Order code: 332007

TROWEL



- Cast aluminium & mirror polished
- Ergonomic soft PVC grip
- Size: 11.6"(L)×2.9"(W)×1.1"(H)
- 0.019cbm
- Packaging size: 12/48
- Order code: 332009

TRANSPLANTER



- Cast aluminium & mirror polished
- Ergonomic soft PVC grip
- Size: 11.6"(L) × 2.3"(W) × 1.1"(H)
- 0.022cbm
- Packaging size: 12/48
- Order code: 332010

2-IN-1 DIGGER & HOF



- Digger & Hoe
- Carbon steel ith powder coating
- Soft PVC ergonomic handle
- Size: 11.5"(L) × 7.2"(W) × 3.0"(H)
- 0.064cbm
- Packaging size: 12/48
- Order code: 332008

SEEDLING HEAT MAT

SEEDLING HEAT MAT FOR BETTER PLANT GROWTH AND FLOWER SEED GERMINATION

- Warms root area 10 to 20 degrees over ambient temperature
- Increases the success of seedlings and cuttings
- Durable construction, waterproof and easy cleaning
- Can be placed in many different sizes of seedling bowl



DESCRIPTION	ORDER CODE	WATT	DIMENSIONS
SEEDLING HEAT MAT 10" x 20.75"	330101	18W	10"W x 20.75"L
SEEDLING HEAT MAT 20" x 20.75"	330102	45W	20"W x 20.75"L
SEEDLING HEAT MAT 48" x 20.75"	330103	105W	48"W x 20.75"L

HEAT MAT THERMOSTAT

OUR ELECTRONIC TEMPERATURE CONTROLLER IS COMPATIBLE WITH ALL HEAT MATS AND IS AN OPTIONAL ACCESSORY FOR SEEDLING HEAT MATS. THE THERMOSTAT CONTROLS THE TEMPERATURE OF HEAT MATS EVENLY IN COLDER OR WARMER THAN NORMAL ENVIRONMENTS. IT PROVIDES CONSTANT OPTIMUM TEMPERATURES FOR SPECIFIC PLANTS.

- Digital temperature controller for heat mats
- Provides constant optimum temperatures for specific crops
- Illuminated indicator light; 3-prong ground plug
- Compatible with all heat mats; optional for Seedling Heat Mats
- Celsius or Fahrenheit read-out



DESCRIPTION	ORDER CODE	PRECISE TEMPERATURE CONTROL
HEAT MAT THERMOSTAT	330118	68-108°F/20-42°C

GREEN PLASTIC COATED PLANT STAKE

- Steel racks for flower and vegetable support
- Made of steel, covered with PE
- Size varied
- Be widely used in garden
- MOQ: 2000 pcs



DESCRIPTION	ORDER CODE	PE PLASTIC COATED IRON PIPE	IRON PIPE SPECIFICATIONS	WEIGHT PER PRODUCT	FILM PACKAGING	PACKAGING SIZE	DIMENSION	PACKAGING QUANTITY
GREEN PLASTIC COATED PLANT STAKE 2'	332801	Φ8 x L600MM	Φ7 x L0.25MM	35G	20	24.4" x 8.2" x 4.3"	0.014	140
GREEN PLASTIC COATED PLANT STAKE 3'	332802	Φ8 x L900MM	Φ7 x L0.25MM	52G	20	36.2" x 8.2" x 4.3"	0.021	140
GREEN PLASTIC COATED PLANT STAKE 4'	332803	Φ11 x L1200MM	Φ10 x L0.25MM	96G	20	48" x 7.2" x 5.5"	0.032	100
GREEN PLASTIC COATED PLANT STAKE 6'	332804	Φ16 x L1800MM	Φ15 x L0.28MM	224G	20	71.6" x 7.4" x 4.3"	0.038	50
GREEN PLASTIC COATED PLANT STAKE 8'	332805	Φ20 x L2400MM	Φ19 x L0.3MM	396G	10	95.2" x 9.4" x 5.9"	0.087	50

FLOWER STAKES

- Steel racks for flower and vegetable support
- Made of steel, covered with PE
- Size varied
- Be widely used in garden
- MOQ:1000 pcs



DESCRIPTION	ORDER CODE	MASTER CARTON	PCS/MASTER CARTON	WEIGHT
FLOWER STAKES Φ0.7 x 45cm 3 rings(Φ18/16/5.5")	332811	31.4" x 7.8" x 19.2"	60 sets	7.3kg
FLOWER STAKES Φ0.7 x 60cm 3 rings(Φ22/20/7")	332812	31.4" x 9.4" x 25.1"	60 sets	8.5kg
FLOWER STAKES Φ0.7 x 75cm 3 rings(Φ28/26/8.6")	332813	31.4" x 11.8" x 31.1"	60 sets	11.8kg
FLOWER STAKES Φ0.7 x 90cm 3 rings(Φ30/28/10.2")	332814	31.4" x 12.4" x 37"	60 sets	13.1kg

GROW CAP

- Stackable. Reusable BPA and lead-free plastic
- Built-in overflow system where excess water and nutrients are delivered straight to the rootball, 360° bottom lip directs all water and nutrients to your plant
- Holes in all four corners for leftover water drainage



DESCRIPTION	ORDER CODE	COLOR	WEIGHT	MATERIAL	CASE QTY
4 IN GROW CAP	334100	GREEN	--	100% ABS, BPA AND LEAD-FREEPLASTIC	90
6 IN GROW CAP	334101	GREEN	93G	100% ABS, BPA AND LEAD-FREEPLASTIC	90
8 IN GROW CAP	334102	GREEN	135G	100% ABS, BPA AND LEAD-FREEPLASTIC	60
GROW CLIP(6 PACK)	334103	GREEN	18G	100% ABS, BPA AND LEAD-FREEPLASTIC	--

4" & 6" ROCK WOOL



DESCRIPTION	ORDER CODE	PRODUCT SIZE	MATERIAL	PRODUCT DENSITY	PACKAGE	PRODUCT DIMENSIONS	N.W./G.W.	CASE QTY
4" ROCKWOOL TUBE	333405	4" x 4" x 4"/HOLE 1.6"(DIA) x 1.6"(HEIGHT)	BASALT, DOLOMITE AND HYDROPHILIZING AGENT	80KG/m ³	CARTON	24" x 24" x 20.5"	15.40/14.40	180
6" ROCKWOOL TUBE	333406	6" x 6" x 6"/HOLE 6"(DIA) x 6"(HEIGHT)	BASALT, DOLOMITE AND HYDROPHILIZING AGENT	80KG/m ³	CARTON	24" x 24" x 18.5"	13.96/12.96	48

GROWROOM LENSES

- Light weight design for all-day comfort
- Adjustable nose piece reduces slippage and provides a personalized, comfortable fit
- Net weight: 13kgs, gross weight: 15kgs
- 300 pieces/carton



DESCRIPTION	ORDER CODE	PACKING
GROWROOM LENSES	333101	1 PC/POLYBAG, 12 PCS/INNER BOX, 300 PCS/CTN
EYEGLASSES CASE	333111	---

LED HEADLIGHT 19 LED

- This convenient, practical, handsfree lamp has 19 high-intensity LED lamps that can be used with different settings. Light can be tilted to maximize its efficiency
- 100,000+ hours of burn time
- Uses three AAA batteries (not included)
- Material: ABS, product size: 75g
- Packaging: 28" x 16" x 22" (100pcs/carton)



DESCRIPTION	ORDER CODE
LED HEADLIGHT 19 LED	333122

MEASURING SHOT GLASS 1.5 OZ.

- General purpose measuring shot glass
- Clear glass for easy and accurate measuring.
- Packaging Detail: 12pcs/box
- Packaging Dimensions: 6.6" x 2.3" x 8.2"



DESCRIPTION	ORDER CODE
MEASURING SHOT GLASS 1.5 OZ	332921

LED FLASHLIGHT

- Compact, long lasting, 9 powerful high-intensity LED lamps, 100000+hours of burn time, uses three AAA batteries (not included)
- AELC-Clips to the underside brim of most caps
- 6 high-intensity LED lamps for extended viewing range
- Material: aluminum
- Product size: 1.1" x 3.4"
- Packaging: 1.2" x 1.2" x 3.8"



DESCRIPTION	ORDER CODE
LED FLASHLIGHT FOR PLANT GROWTH	333121

STERILE DISPOSABLE SCALPEL

- Use this individually wrapped sterilized scalpel for all your plant cuttings
- A sterile scalpel will help prevent disease and damage to any cutting
- Sold in box quantities only
- Packaging Detail: 500pcs/ctn
- Packaging Dimensions: 16.9" x 12.9" x 8.4"



DESCRIPTION	ORDER CODE
STERILE DISPOSABLE SCALPEL	332854

1/2" SMALL PLASTIC FLOAT VALVE DN15WK

- Body: ABS
- Float Ball: PE(Polyethylene)
- Seals: SR(Silicon Rubber)
- O' Ring: NBR(Nitrile Butadiene Rubber)
- Working Pressure: 0.01- 1.2Mpa (0.1Mpa=1Bar=14.5Psi)
- Working Temperature: 0-70°C



DESCRIPTION	ORDER CODE	INSTALL SIZE	THREAD
1/2" SMALL PLASTIC FLOAT VALVE DN15WK	330601	6.8" (MAXIMUM)	1/2"

GARDENER TRELLIS NETTING

- Heavy-duty nylon netting is ideal for growing tomatoes, peas and all vine crops 7" reach through mesh



DESCRIPTION	ORDER CODE	NETTING SIZE	MESH SIZE	PACKAGING SIZE	CASE QTY
GARDENER TRELLIS NETTING	330701	5FT x 15FT	6" x 6"	23.23"(L) x 18.9"(W) x 14.96"(H)	10
GARDENER TRELLIS NETTING	330702	5FT x 30FT	6" x 6"	23.23"(L) x 18.9"(W) x 14.96"(H)	10
GARDENER TRELLIS NETTING	330703	10FT x 15FT	6" x 6"	23.23"(L) x 18.9"(W) x 14.96"(H)	10

WHITE TRELLIS NETTING BULK ROLL



-Made from commercial grade polypropylene
 -Resistant to horticulture chemicals and heat
 -6"x 6" provides the highest level off strength, support and durability
 -Tangle free design offers easy installation and handling



DESCRIPTION	ORDER CODE	MATERIAL
GARDENER TRELLIS NETTING 6.5FT x 25FT	330712	PP, UVA STABILIZED POLYPROPYLENE
GARDENER TRELLIS NETTING 5FT x 100FT	330715	PP, UVA STABILIZED POLYPROPYLENE
GARDENER TRELLIS NETTING 5FT x 500FT	330716	PP, UVA STABILIZED POLYPROPYLENE
GARDENER TRELLIS NETTING 5FT x 1000FT	330717	PP, UVA STABILIZED POLYPROPYLENE
GARDENER TRELLIS NETTING 4FT x 3300FT	330718	PP, UVA STABILIZED POLYPROPYLENE
GARDENER TRELLIS NETTING 6.5FT x 3300FT	330711	PP, UVA STABILIZED POLYPROPYLENE

PLASTIC MEASURING CUP

DESCRIPTION	ORDER CODE	SPECIFICATIONS	MATERIAL
PLASTIC MEASURING CUP 250 ML	332931	WITH U.S. AND METRIC MARKINGS AND REINFORCED HANDLE.	FOOD GRADE PP
PLASTIC MEASURING CUP 500 ML	332932	WITH U.S. AND METRIC MARKINGS AND REINFORCED HANDLE.	FOOD GRADE PP
PLASTIC MEASURING CUP 1000 ML	332933	WITH U.S. AND METRIC MARKINGS AND REINFORCED HANDLE.	FOOD GRADE PP
PLASTIC MEASURING CUP 2000 ML	332934	WITH U.S. AND METRIC MARKINGS AND REINFORCED HANDLE.	FOOD GRADE PP
PLASTIC MEASURING CUP 5000 ML	332935	WITH U.S. AND METRIC MARKINGS AND REINFORCED HANDLE.	FOOD GRADE PP



Available in five convenient sizes.

40X GARDEN DETECTING LOUPE

DESCRIPTION	ORDER CODE	LEN DIAMETER	SIZE
40X GARDEN DETECTING LOUPE	330401	21MM	1.37" x 0.91" x 0.67"



40X ILLUMINATING PORTABLE MICROSCOPE

DESCRIPTION	ORDER CODE
40X ILLUMINATING PORTABLE MICROSCOPE40X	330402



LIGHTED MICROSCOPE ZOOM-LENS 60X-100X

DESCRIPTION	ORDER CODE
LIGHTED MICROSCOPE ZOOM-LENS 60X-100X	330403



PLANT CLIPS

- Easy to use & remove spring clips for supporting plant and seedling stems
- Attaches stem to cane, rod or wire to help support, straighten or direct to sunlight
- Protects delicate flowers against wind damage, bolster fruit-laden branches
- Won't harm plant or hinder growth; weatherproof & non-rusting, spring steel wire
- Set of 20 clips - 10 each regular 1" and large 1-1/2"



DESCRIPTION	ORDER CODE	PACKAGING DETAIL
PLANT CLIPS	332882	10 PCS SMALL PLANT CLIPS AND 10 PCS LARGE PLANT CLIPS

TWIST TIE 164 FT

- 164 ft (50 meters) perfect for securing plants to trellis stakes, or other supports
- This package also includes a built-in cutting tool for added convenience
- Packaging Detail: 144pcs/ctn
- Packaging Dimensions: 19.6" x 15.8" x 6.2"



DESCRIPTION	ORDER CODE	PACKAGING DIMENSIONS	PACKAGING Detail
TWIST TIE 164FT	332881	19.6" x 15.8" x 6.2"	144 PCS / CTN

SOFT GARDEN PLANT BENDING WIRE

- Soft Garden Plant Tie with UV inhibitors to attach plant stems to stakes or support racks easily without damaging your plants
- It is great for indoor or outdoor use It is reusable and long lasting
- It is a soft, foam coated wire that is flexible and easy to cut



DESCRIPTION	ORDER CODE	SIZE	PACKAGING SIZE	G.W.	CASE QTY
SOFT GARDEN PLANT BENDING WIRE 5MM - 16 FT	332883	0.19" X 192.1"	15.7" X 7.9" X 22.8"	11KG	60
SOFT GARDEN PLANT BENDING WIRE 5MM - 50 FT	332884	0.19" X 600.3"	15.7" X 7.9" X 16.5"	11KG	20

PLANT STAKE LABELS

- Use these plant stake labels to make the type of seeds that you plant.
- Sold in box quantities only.
- Packaging dimensions: 1.9" x 3.9" x 0.7", packaging detail: 1000pcs/box, Each stake is 4" x 0.8".



DESCRIPTION	ORDER CODE	COLOR
PLANT STAKE LABELS (1000/BOX)	333821-W	WHITE
PLANT STAKE LABELS (1000/BOX)	333821-P	PINK
PLANT STAKE LABELS (1000/BOX)	333821-B	BLUE
PLANT STAKE LABELS (1000/BOX)	333821-G	GREEN
PLANT STAKE LABELS (1000/BOX)	333821-Y	YELLOW

GLASS STORAGE JAR W/ METAL CLAMP LID

- Glass Jars with Metal Clamp Lid are a vintage looking storage solution for: Herbs, dried fruits and vegetables and hundreds of other items!
- These metal clamp lid jars deliver freshness with an air-tight seal.
- The metal clamp closure with a gasket provides a strong touch of charm.
- Hand wash only.



DESCRIPTION	ORDER CODE	PRODUCT SIZE	CAPACITY	MATERIAL	PRODUCT WEIGHT	PACKAGING DIMENSIONS	N.W./G.W.	Case QTY
GLASS STORAGE JAR W/ METAL CLAMP LID--16 OZ	332951	4.3" x 3.5" x 4.3"	450ML 16 OZ	HIGHLY-WHITE GLASS, 304 STAINLESS STEEL, 0.1" SILICONE PAD	550g	17.7"x13.4"x12.9"	13.20/14.20kg	24
GLASS STORAGE JAR W/ METAL CLAMP LID--24 OZ	332952	4.3"x4.3"x5.7"	700ML 24 OZ	HIGHLY-WHITE GLASS, 304 STAINLESS STEEL, 0.1" SILICONE PAD	700g	17.7"x13.4"x18.1"	16.80/17.80kg	24
GLASS STORAGE JAR W/ METAL CLAMP LID--32 OZ	332953	4.3"x3.5"x6.7"	950ML 32 OZ	HIGHLY-WHITE GLASS, 304 STAINLESS STEEL, 0.1" SILICONE PAD	800g	18.1"x13.8"x14.1"	9.60/10.60kg	12
GLASS STORAGE JAR W/ METAL CLAMP LID--48 OZ	332954	4.7"x4.7"x8.7"	1500ML 48 OZ	HIGHLY-WHITE GLASS, 304 STAINLESS STEEL, 0.1" SILICONE PAD	1000g	18.9"x14.1"x18.1"	12.00/13.00kg	12
GLASS STORAGE JAR W/ METAL CLAMP LID--105 OZ	332955	5.7"x3.8"x10.4"	3000ML 105 OZ	HIGHLY-WHITE GLASS, 304 STAINLESS STEEL, 0.1" SILICONE PAD	1650g	24.4"x18.1"x11"	19.80/20.80kg	12

VACUUM SEAL ROLLS



- Size: 11" x 196.8"
- Weight per roll: 0.28kg
- Smooth side 80 micra, channel side 105 micra, total 185 micra
- High quality PA/PE food packaging vacuum sealer roll
- Food Sealer Bags Rolls
- Embossing for vacuum function, BPA free

DESCRIPTION	ORDER CODE	PACKAGE	PACKAGING DIMENSIONS	N.W./G.W.	Case QTY
VACUUM SEAL ROLLS	332961	2 ROLLS WRAPPED IN SHRINKABLE FILM	17.7" x 12.7" x 12.2"	9.4/10.4KGS	34

16" BOWL TUMBLE TRIMMER

- This trimmer is media size with stainless construction.
- Help you trim the protruding roots and leaves.
- Clockwise and anti-clockwise rotating
- Manual manipulation
- Compact design requires minimum space
- After use easy to clean
- Super Lightweight
- Easy use and easy carry
- Safety and no flower damage
- With stainless steel twist spin blade



DESCRIPTION	ORDER CODE	SIZE & COLOR SHAPE	VOLT/FREQ	MACHINE SIZE(CM)	CARTON SIZE(CM)	N.W. (KGS)	G.W. (KGS)	PACKAGING	MOQ
16" BOWL TUMBLE TRIMMER	331902	16 INCH / SILVER ROUND	110V-120V/60HZ 220-230V-240V/50HZ	15.9" x 15.9" x 14"	16.9" x 16.9" x 14.9"	5.5	6.3	1PC/WHITE BOX (WATERPROOF)	100 PCS

POWDER FREE NITRILE GLOVES

- Three times more puncture resistant than latex or vinyl
- Textured fingertips for a better grip, exceptional tensile strength
- Powder and latex free, reversible to fit either hand



DESCRIPTION	ORDER CODE	PACKAGING DETAIL
POWDER FREE NITRILE GLOVES SMALL(100/BOX)	332827S	100PCS/BOX
POWDER FREE NITRILE GLOVES SMALL(100/BOX)	332827M	100PCS/BOX
POWDER FREE NITRILE GLOVES SMALL(100/BOX)	332827L	100PCS/BOX
POWDER FREE NITRILE GLOVES SMALL(100/BOX)	332827XL	100PCS/BOX

ID CARD HOLDER-VERTICAL STYLE

- Heavy Duty ID sleeve/pouch protector outer
- Durable PVC (poly vinyl chloride) material, wear-resistant and corrosion-resistant properties
- Dual-use hanging slot/holes design



DESCRIPTION	ORDER CODE	MATERIAL	PRODUCT DIMENSIONS
ID CARD HOLDER-VERTICAL STYLE	332830	PVC	2.6"(L) x 4.2"(W) x 0.2"(H)

STICKY MATS (30 LAYERS PER PAD)

- Each mat adheres to the floor and has 30 tear-off, numbered layers of sticky film
- Sheets size 24 inches x 36 inches
- 30 sheets per mat 10 mats per case, 1 case 10 mats 300 Sheets
- Perfect for construction sites, hospital renovations, laboratory, electronic manufacturing plants, and cleanroom applications

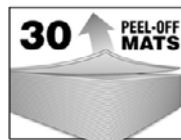

MOQ: 2000 PCS

DESCRIPTION	ORDER CODE	MATERIAL	PRODUCT DIMENSIONS	PACKAGING DIMENSIONS	N.W.	G.W.	CTN QTY
STICKY MATS (30 LAYERS PER PAD)	332831	LDPE	24"(L) x 36"(W)	37"(L) x 26"(W) x 7"(H)	48.5KG	50KG	50

PLASTIC SHOE COVER (100/PACK)

- Disposable shoe covers be used to protect carpets or floors from the outside
- Inexpensive - a cheaper way to cut down on dirt and germs
- Made by machine - better quality compare to normal hand-made shoe cover
- Fits men's shoes up to size 11, easy to put on and take off



MOQ: 2000 PCS

DESCRIPTION	ORDER CODE	MATERIAL	PRODUCT DIMENSIONS	PACKAGING DIMENSIONS	N.W.	G.W.	Case QTY
PLASTIC SHOE COVER (100/PACK)	332832	PE	19.8"(L) x 5"(W)	18.9"(L) x 18.9"(W) x 18.5"(H)	8KG	9KG	40

NON-WOVEN FABRIC SHOE COVER (30/PACK)



- Material: made of high quality non-woven fabric
- Lightweight for portable carry
- Convenient and easy to use, perfect partner for travelling, camping, hiking etc
- Package - 30 pcs/1 set shoes covers are included in the package

MOQ: 2000 PCS

DESCRIPTION	ORDER CODE	MATERIAL	PRODUCT DIMENSIONS	PACKAGING DIMENSIONS	N.W.	G.W.	Case QTY
NON-WOVEN FABRIC SHOE COVER (30/PACK)	332833	NON-WOVEN FABRIC	19.8"(L) x 5"(W)	18.9"(L) x 18.9"(W) x 18.5"(H)	8KG	9KG	50

SHOE COVER DISPENSER



- Sick of dirty shoes or wellies on your carpets? An innovative walk in shoe cover dispenser with 50 disposable shoe covers is the answer!
- Easy to use & refill therefore it will be used No bending required!
- Use to protect office floors and carpets where operatives enter from dirty areas

MOQ: 500 PCS

DESCRIPTION	ORDER CODE	PRODUCT DIMENSIONS	PACKAGING DIMENSIONS	N.W.	G.W.	Case QTY
SHOE COVER DISPENSER	332834	16.5"(L) x 8.6"(W) x 5.2"(H)	17.8"(L) x 9.9"(W) x 6.3"(H)	2.1KG	2.3KG	1

CLEAN ROOM BODY SUIT



- Material: non-woven microporous
- Product weight: 150g (55gsm)
- Package: PE bag
- Protection against Type 4 /5 /6
- (Type4 = Spray-tight type liquid chemicals, Type 5 =airborne solid particulate chemicals, Type 6=limited protection against liquid mist)

MOQ: 2000 PCS

DESCRIPTION	ORDER CODE	MATERIAL	PRODUCT DIMENSIONS	PACKAGING DIMENSIONS	N.W.	G.W.	CASE QTY
CLEAN ROOM BODY SUIT - SIZE L	332835L	NON-WOVEN MICROPOROUS	69"(Height) x 55"(Chest)	19.7"(L) x 11.8"(W) x 16.5"(H)	9KG	10KG	50
CLEAN ROOM BODY SUIT - SIZE XL	332835XL	NON-WOVEN MICROPOROUS	74"(Height) x 62"(Chest)	19.7"(L) x 11.8"(W) x 16.5"(H)	9KG	10KG	50

DEHUMIDIFIER

- Computer automatic control
- Current environment temperature and humidity colorful LCD display
- Efficient and automatic defrosted system, low temperature appliance
- Have fault automatically judgment function
- 1-24 Hours timing function
- Special humidity 1% PH can be adjusted, humidity setting range 10%-98% RH
- Pipe continue drainage function
- Bottom caster, can move freely
- International famous brand Mitsubishi compressor
- 1 Year limited warranty for the whole machine
- 3 year limited warranty for the compressor



435 Pint



225 Pint

DESCRIPTION	ORDER CODE	COMPRESSION ENGINE	HUMIDITY REMOVAL	WATT	CIRCULATING AIR	REFRIGERANT	APPLYING SPACE	NET WEIGHT	DIMENSIONS	CASE QTY
DEHUMIDIFIER 435 PINT 240L/D	331711	MITSUBISHI	240L/D	3400W	2800M ³ /H	R407C	300-350M ²	130KG	30" x 19" x 70"	1
DEHUMIDIFIER 225 PINT 110L/D	331712	PANASONIC	110L/D	1300W	600M ³ /H	R140A	130-150M ²	50KG	19" x 17" x 37.4"	1

HOUSEHOLD HUMIDIFIER

- Increases humidity in dry living spaces
- Removes unpleasant odour and food smell
- Removes dust and indoor air pollution
- Disinfects and deodorizes indoor air
- Creates clean, hygienic and bacteria-free air
- Place: Applicable for room size: 30m²
- Working time: 14-28 hours
- Caution: Better use clean water
- Better switch off when power off
- Waterless automatic protection
- Mist-out mouth rotatable at 360°C
- Chrome decorated switch for Mist Adjustment, Time setting and Night Light
- Removable water tank with a wide mouth for easy filling
- Low noise



MOQ: 100 PCS

DESCRIPTION	ORDER CODE	WORKING TIME	NET WEIGHT	GROSS WEIGHT	GIFTBOX SIZE	CARTON SIZE	PACKAGES
HOUSEHOLD HUMIDIFIER	331702	14-28HOURS	1.50KGS	2.10KGS	10.8" x 10.4" x 13.6"	32.3" x 11.6" x 28"	6PCS/CTN

ELECTROMAGNETIC AIR PUMP

- The case is made of high quality ZL 102 aluminum alloy with integrated radiation fins designed for effective heat dissipation
- Maximum air production is achieved using straight-line reciprocal motion driven by an electromagnetic motor
- Components constructed of high quality SF new-type wear resistant material providing efficient power consumption and maximum performance
- Oil free lubricated design ensures purified compressed air
- Maintains consistent temperature and pressure for reliable operation



DESCRIPTION	ORDER CODE	VOLTAGE FREQUENCY	POWER	QMAX (GPH)	OUTPUT (L/MIN)	PRESSURE (L/MPA)	OUTLETS	G.W.	PACKAGING DIMENSIONS	Case QTY	MOQ
ELECTROMAGNETIC AIR PUMP - 18 WATT (555GPH)	332541	120V/60Hz	18W	555	35	>0.015mpa	6	17.6 KG	18.3"(L) X 9.8"(W) X 14.2"(H)	18	18
ELECTROMAGNETIC AIR PUMP - 32 Watt (951GPH)	332542	120V/60Hz	32W	951	60	>0.02mpa	6	21 KG	18.5"(L) X 9.4"(W) X 16.5"(H)	12	12
ELECTROMAGNETIC AIR PUMP - 70 Watt (1268GPH)	332543	120V/60Hz	70W	1268	80	>0.03mpa	8	20.4 KG	11.4"(L) X 10.2"(W) X 19.7"(H)	6	6
ELECTROMAGNETIC AIR PUMP - 175 Watt (4359GPH)	332544	120V/60Hz	175W	4359	275	>0.045mpa	12	35.8 KG	14.6"(L) X 14.2"(W) X 17.7"(H)	4	4

SUBMERSIBLE WATER PUMP

- Mag-drive motor technology makes this pump energy efficient and easy to maintain
- Protective pump input strainer cover and sponge filter prevents debris from damaging internal parts, reducing maintenance and prolonging pump life
- Included three-way splitter allows universal connectivity with most hose sizes
- The wide flat base and rubber feet make the pump stable and reduce vibration



DESCRIPTION	ORDER CODE	VOLTAGE FREQUENCY	POWER	F.MAX	H.MAX	OUTLET DIAMETER	G.W.	PACKAGING DIMENSIONS	Case QTY
SUBMERSIBLE WATER PUMP 18W(317GPH)	332561	110V	18W	317GPH	6.56FT	0.55"/0.79"/0.69" (WITH GAS NOZZLE)	18.7 KG	15.6"(L) X 12.4"(W) X 16.5"(H)	18
SUBMERSIBLE WATER PUMP 35W(634GPH)	332562	110V	35W	634GPH	8.20FT	0.55"/0.79"/0.69" (WITH GAS NOZZLE), 0.77" (BIG NUT WITH GAS NOZZLE)	22.5 KG	17.1"(L) X 14.0"(W) X 12.3"(H)	12
SUBMERSIBLE WATER PUMP 90W(1268GPH)	332563	110V	90W	1268GPH	14.76FT	0.72"(WITH GAS NOZZLE)/1.02"/1.08"	12.0 KG	14.2"(L) X 10.3"(W) X 15.3"(H)	4
SUBMERSIBLE WATER PUMP 130W(1585GPH)	332564	110V	130W	1585GPH	16.40FT	0.72"(WITH GAS NOZZLE)/1.02"/1.08"	12.0 KG	14.2"(L) X 10.3"(W) X 15.3"(H)	4
SUBMERSIBLE WATER PUMP 230W(2113GPH)	332565	110V	230W	2113GPH	18.04FT	0.86"/1.00"/1.24"	18.0 KG	14.3"(L) X 11.5"(W) X 15.3"(H)	4

AIR PUMP



1-YEAR WARRANTY

DESCRIPTION	ORDER CODE	VOLTAGE FREQUENCY	POWER	QMAX(GPH)	OUTPUT (L/MIN)	PRESSURE (L/MPA)	OUTLETS	G.W.	Case QTY	MOQ	PACKAGING DIMENSIONS
AIR PUMP 1 OUTLET 2.5 WATT	332551	120V/60Hz	2.5W	25	1.5	>0.012	1	0.27 KG	24	24	15"(L) X 13.4"(W) X 7.9"(H)
AIR PUMP 2 OUTLET 2.5 WATT	332552	120V/60Hz	2.5W	50	2 x 1.5	>0.015	2	0.29 KG	24	24	15"(L) X 13.4"(W) X 7.9"(H)
AIR PUMP 4 OUTLET 8.5 WATT	332553	120V/60Hz	8.5W	285	4 x 4.5	>0.013	4	0.93 KG	12	12	18.3"(L) X 18.3"(W) X 8.7"(H)

ROUND AIR STONE (DISC)



1-YEAR WARRANTY

- Air Discs are great way to add oxygen to your hydroponic growing system
- The micro-pore design energizes your growing solution as it aerates and circulates your nutrients
- They will extend the life of your nutrient solutions
- Help keep your roots healthy and promote exceptional growth
- The air disc has a built-in, 3/8 inch 90 degree elbow fitting that insures the airline connects freely to your fitting



DESCRIPTION	ORDER CODE	TUBE SIZE	PACKAGING DIMENSIONS
4" ROUND AIR STONE(DISC)	332521	3/8"	4.2" x 0.8" x 0.2"
6" ROUND AIR STONE(DISC)	332522	3/8"	5.2" x 0.8" x 0.2"
8" ROUND AIR STONE(DISC)	332523	3/8"	7.9" x 1.0" x 0.3"

WATER CHILLER

WATER CHILLER



Microcomputer control system and LCD display, very user friendly !

- Large refrigeration capacity, water can be refrigerated to any degree above 39°F in a short period of time
- Freon free, environmentally friendly
- Temperature memory system
- Surge protected, will turn off if there is a power surge
- Voltage: 100-120V/220-240V, Frequency: 50/60Hz



DESCRIPTION	ORDER CODE	MODEL	VOLTAGE	FREQUENCY	POWER (W)	REFRIGERATING CAPACITY	RECOMMENDED PUMP OUTFLOW	ICED MEDIUM	RECOMMENDED AQUARIUM SIZE		PACKAGING DIMENSIONS	N.W. G.W.	CASE QTY
WATER CHILLER - 1/10 HP (500-1000L/H)	332611	CL-280	100-120V 220-240V	50/60HZ	1/10HP	280W	500-1000L/H 132-264GPH	R134A	≤300L	≤79Gal	11.8"x12.6"x13.8"	13.5kg	1
WATER CHILLER - 1/4 HP (1000-1500L/H)	332612	CL-600	100-120V 220-240V	50/60HZ	1/4HP	600W	1000-1500L/H 265-396GPH	R134A	≤650L	≤172Gal	12.8"x14.4"x15.8"	22.0kg	1
WATER CHILLER - 1 HP (2500-4000L/H)	332614	C-1000P	100-120V 220-240V	50/60HZ	1HP	2700W	2500-4000L/H 660-1000GPH	407C	≤1500L	≤400Gal	16.5"x20.3"x18.9"	40.0kg	1

PUMPLESS RO SYSTEM WITH STANDARD/NEUTRAL CONFIGURATION



- Tank: 3.2G White Steel Tank
- RO Membrane: TFC-50G, TFC-75G, TFC-100G
- Manual Flush Valve(transversely not portrait)
- Four way valve
- European filter housing instead of Asian model-American Faucet
- English neutral package and stickers
- Inlet Pressure: 0.1 Mpa~0.35 Mpa
- Temperature: 5~38°C
- Operating Pressure: 0.4Mpa~0.6Mpa

DESCRIPTION	ORDER CODE	MATERIAL	PACKAGING DIMENSIONS	N.W./G.W.	Case QTY	MOQ
50G PUMPLESS RO SYSTEM WITH STANDARD/NEUTRAL CONFIGURATION	332401	1. PP FILTER 2. CTO 3.GAC 4. 50G RO DRYMEMBRANE (MEMBRANE PAPER FROM TORAY) 5.T33(POST COCONUT CARBON)	16.5" X 13.8" X 23.2"	10.00/10.28KGS	1	300
75G PUMPLESS RO SYSTEM WITH STANDARD/NEUTRAL CONFIGURATION	332402	1. PP FILTER 2. CTO 3.GAC 4. 75G RO DRYMEMBRANE (MEMBRANE PAPER FROM TORAY) 5.T33(POST COCONUT CARBON)	16.5" X 13.8" X 23.2"	10.00/10.28KGS	1	300
100G PUMPLESS RO SYSTEM WITH STANDARD/NEUTRAL CONFIGURATION	332403	1. PP FILTER 2. CTO 3.GAC 4. 100G RO DRYMEMBRANE (MEMBRANE PAPER FROM TORAY) 5.T33(POST COCONUT CARBON)	16.5" X 13.8" X 23.2"	10.00/10.28KGS	1	300

HIGH REJECTION RO MEMBRANE



- Active membrane area ft²(m²): 4.0(0.40), 4.5(0.45), 5.0(0.50)
- Operation Pressure Psi(Mpa): 65(0.45)
- Rejection Rate(%): 97
- Recovery rate(%): 15

DESCRIPTION	ORDER CODE	SPECIFICATIONS	PACKAGING DIMENSIONS	N.W./G.W.	Case QTY	MOQ
50GPD HIGH REJECTION RO MEMBRANE	332411	AVERAGE FLOW RATE GPD(M ³ /D): 50(189L)	12.4" X 12.4" X 12.99"	8.00/9.00KGS	25	≤1000
75GPD HIGH REJECTION RO MEMBRANE	332412	AVERAGE FLOW RATE GPD(M ³ /D): 75(283L)	12.4" X 12.4" X 12.99"	8.00/9.00KGS	25	≤1000
100GPD HIGH REJECTION RO MEMBRANE	332413	AVERAGE FLOW RATE GPD(M ³ /D): 100(378L)	12.4" X 12.4" X 12.99"	8.00/9.00KGS	25	≤1000

RO SYSTEM

PP SEDIMENT FILTER



- Weight:105g
- Size:(ID)1.1"+-0.04"
(OD)2.4"+-0.04"
- Packaging dimensions: 13" x 13" x 21.3"

ORDER CODE	N.W./G.W.	CASE QTY	MOQ
332414	6.50/7.50KGS	50	<1000

GAC- GRANULAR ACTIVATED CARBON FILTER



- Iodine value: 500
- Material: Coal carbon
- Packaging dimensions: 15.7" x 15.7" x 10.6"

ORDER CODE	N.W./G.W.	CASE QTY	MOQ
332415	12.50/13.50KGS	25	<1000

CTO- CARBON BLOCK FILTER



- Iodine value: 500
- Material: Coal carbon
- Packaging dimensions: 15.2" x 15.2" x 11.4"

ORDER CODE	N.W./G.W.	CASE QTY	MOQ
332416	10.00/11.20KGS	25	<1000

T33- POST CARBON FILER



- Iodine value: 600
- Material: Coconut carbon
- Packaging dimensions: 10.6" x 10.6" x 10.8"

ORDER CODE	N.W./G.W.	CASE QTY	MOQ
332417	5.00/6.72KGS	25	<1000

3.2G TANK



- Material:Iron
- Neutral sticker
- Packaging dimensions: 11.0" x 11.0" x 14.6"(0.029m³)

ORDER CODE	N.W./G.W.	CASE QTY	MOQ
332418	2.9/3.3KGS	1	≤100

QUICK CONNECTOR



- Quick connector port 1/4" x 3/8"
- Packaging dimensions: 10.6" x 10.6" x 10.8" (0.06m³)

ORDER CODE	N.W./G.W.	CASE QTY	MOQ
332419	12/13KGS	6000	>1000

GOOSE FAUCET



- Heavy-duty, lead-free
- Packaging dimensions: 21.7" x 14.0" x 19.1"(0.095m³)

ORDER CODE	N.W./G.W.	CASE QTY	MOQ
332420	16/17KGS	40	≤1000

1/4" WHITE TUBE



- 1/4" white tube
- Packaging dimensions: 13.8" x 13.8" x 21.7"(0.067m³)

ORDER CODE	N.W./G.W.	CASE QTY	MOQ
332421	3.00/3.50KGS	500	≤1000

FULL SPECTRUM

HIGH YIELD

ENERGY EFFICIENT

REDUCED HEAT

UNIQUE AIR VENT DESIGN

ITALIAN VEGA 95[®] ALUMINUM

ACCEPTS 3100K OR 4200K LAMP

BUILT-IN DIGITAL BALLAST

315W AMOUR SERIES-CERAMIC METAL HALIDE GROW LIGHT FIXTURE

SINOWELL



Office:

96 Siping Road, Financial Street
Hailun Centre, Tower A,
Room 3603-3604
Shanghai, PRC 200086
Tel: +86 21 5566 9995

Factory:

158 Hangtou Road
Building 4
Shanghai, China 201317
Tel: +86 21 6429 8802



www.sino-well.com