



EVERPURE® EC110 PREFILTER CARTRIDGE

PREFILTER CARTRIDGE FOR E-10 HOUSING

EC110 Prefilter Cartridge: EV9534-12



APPLICATIONS

For All Foodservice Applications
Requiring Prefiltration
High Sediment Areas

FEATURES • BENEFITS

Clear housing lets you visually inspect trapped particles and makes determining when to change the cartridge easy

Durable slim bowl design makes cartridge change outs easy to handle

10-micron sediment filtration

Tightly spun Everpure EC110 Sediment Cartridge delivers 10-micron nominal filtration

Extends the life of primary filter cartridges

Filters out large dirt and rust particles

Fits most 10" drop-in housings

INSTALLATION TIPS

Choose a mounting location suitable to support the full weight of the system when operating.

OPERATION TIPS

Inspect Everpure EC110 Cartridge periodically to determine dirt load.

Replace Everpure EC110 Cartridge when dirt has penetrated through to the inner core of the cartridge.

Do not exceed service flow rate.

Inspect o-ring during each cartridge change. Lubricate and/or replace if necessary.

EVERPURE® EC110 PREFILTER CARTRIDGE

EV9534-12

SPECIFICATIONS

Overall Dimensions

9.75" L x 2.5" D (24.7 cm x 6.3 cm)

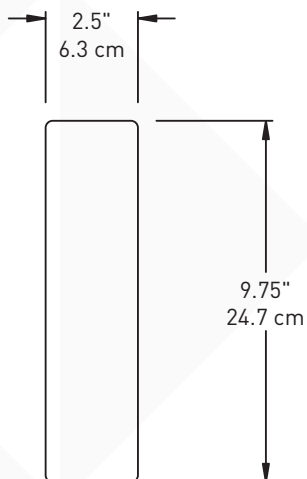

The contaminants or other substances removed or reduced by this drinking water system are not necessarily in your water. Do not use with water that is microbiologically unsafe or of unknown quality without adequate disinfection before or after the system. Systems certified for cyst reduction may be used with disinfected water that may contain filterable cysts.

WARRANTY

Everpure water treatment systems by Pentair® (excluding replaceable elements) are covered by a limited warranty against defects in material and workmanship for a period of five years after date of purchase. Everpure replaceable elements (filter cartridges and water treatment cartridges) are covered by a limited warranty against defects in material and workmanship for a period of one year after date of purchase. See printed warranty for details. Pentair will provide a copy of the warranty upon request.



WATER QUALITY SYSTEMS

EVERPURE-SHURFLO WORLD HEADQUARTERS, 1040 MUIRFIELD DRIVE, HANOVER PARK, IL 60133 USA • FOODSERVICE.PENTAIR.COM
800.942.1153 (US ONLY) • 630.307.3000 MAIN • 630.307.3030 FAX • CSEVERPURE@PENTAIR.COM EMAIL

EVERPURE-SHURFLO AUSTRALIA, 1-21 MONASH DRIVE, DANDENONG SOUTH, VIC 3175 AUSTRALIA
011.1300 576 190 TEL • 011.61.39.562.7237 FAX • AU.EVERPURE@PENTAIR.COM EMAIL

EVERPURE-SHURFLO CHINA, 21F CLOUD 9 PLAZA, NO 1118, SHANGHAI, 200052, CHINA
86.21.3211.4588 TEL • 86.21.3211.4580 FAX • CHINA.WATER@PENTAIR.COM EMAIL

EVERPURE-SHURFLO INDIA, GREEN BOULEVARD, B-9/A, 7TH FLOOR - TOWER B SECTOR 62, NOIDA - 201300
91.120.419.9444 TEL • 91.120.419.9400 FAX • INDIACUSTOMER@PENTAIR.COM EMAIL

EVERPURE-SHURFLO EUROPE, PENTAIR WATER BELGIUM BVBA, INDUSTRIEPARK WOLFSTEE, TOEKOMSTLAAN 30, B-2200 HERENTALS, BELGIUM
+32.(0).14.283.504 TEL • +32.(0).14.283.505 FAX • SALES@EVERPURE-EUROPE.COM EMAIL

EVERPURE-SHURFLO JAPAN INC., HASHIMOTO MN BLDG. 7F, 3-25-1 HASHIMOTO, MIDORI-KU, SAGAMIHARA-SHI KANAGAWA 252-0143, JAPAN
81.(0)42.775.3011 TEL • 81.(0)42.775.3015 FAX • INFO@EVERPURE.CO.JP EMAIL

EVERPURE-SHURFLO SOUTHEAST ASIA, 390 HAVELOCK ROAD, #04-01 KING'S CENTRE, SINGAPORE 169662
65.6768.5800 TEL • 65.6737.5149 FAX • CSEVERPURE@PENTAIR.COM EMAIL

All Pentair trademarks and logos are owned by Pentair, Inc. or its affiliates. All other registered and unregistered trademarks and logos are the property of their respective owners. Because we are continuously improving our products and services, Pentair reserves the right to change specifications without prior notice. Pentair is an equal opportunity employer.