

WOODLAND PLATFORM

ASSEMBLY INSTRUCTIONS

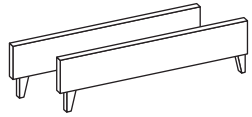

PARTS



2 End Rails
with legs attached

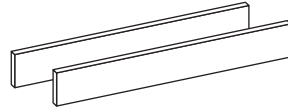

2 Side Rails

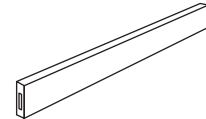

1 Center Support
Beam

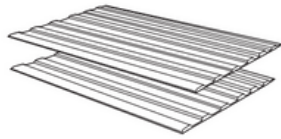

2 Fabric Encased
Slats

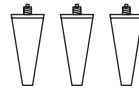

3 Loose Wood
Legs

ASSEMBLY

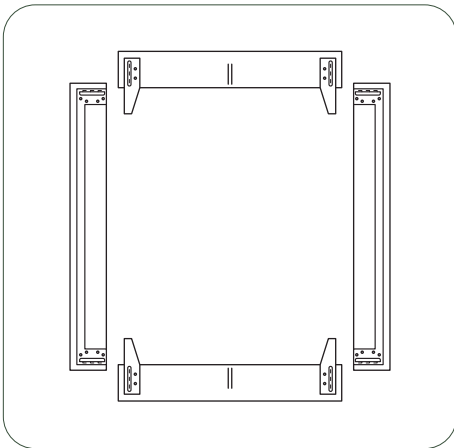

- 1** Layout boards to make a rectangle.

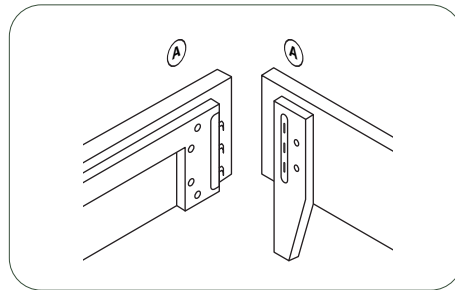

- 2** Connect End Rail to Side Rail by matching up the Letters AA, BB, CC, DD

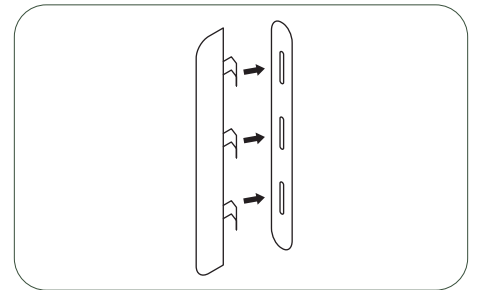

- 3** Confirm the hooks are placed into the brackets secure and tight.

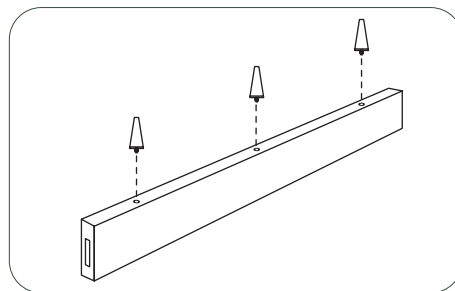

- 4** Screw in the legs to the bottom of the Center Support

ASSEMBLY

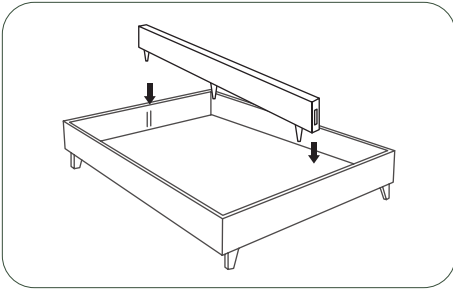

5 Slide the middle support beam into its brackets

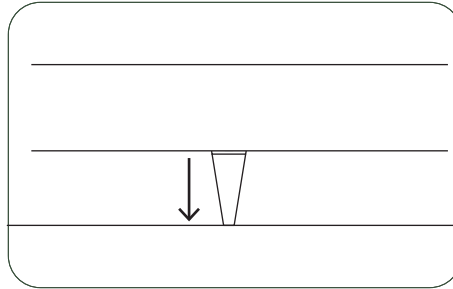

6 Remember to adjust the legs to touch the floor, this will give you the best support.

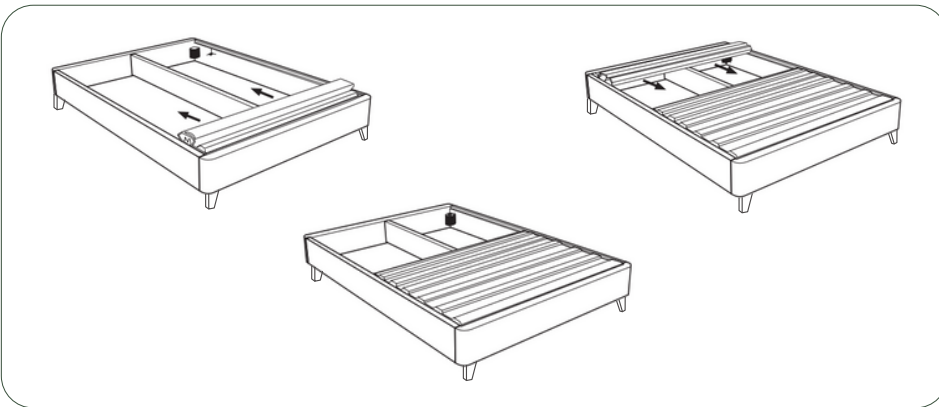

7 Place the slats on the frame with the strips to the bottom and stretch to each end, attach to the Velcro.

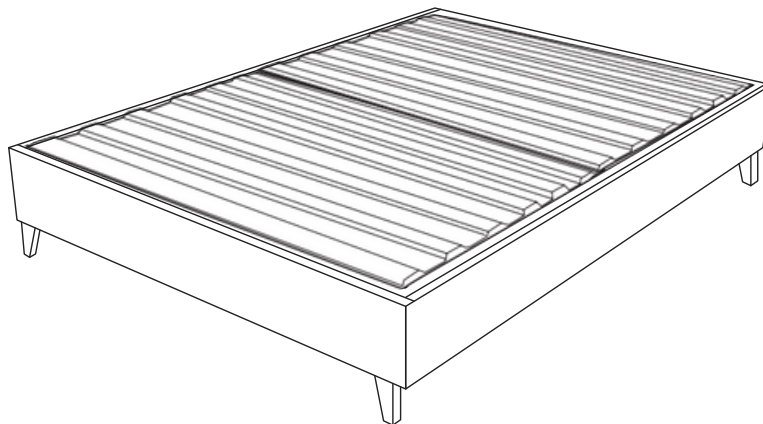

Need Assembly Assistance?

We are available via Live Chat! at [Nestbedding.com](https://www.nestbedding.com)

Call us at 1-800-992-2001

Email us at customerservice@nestbedding.com